

## BasicWall

### DESIGN:

Rom & Tonik

*Basic Wall is a classic and efficient sound absorber, available in five different sizes.*

*Wall brackets for invisible fixing is included. Combine different sizes and colours to create graphic minimalist patterns.*

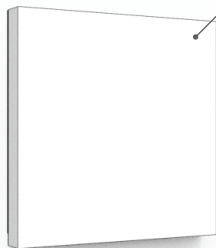
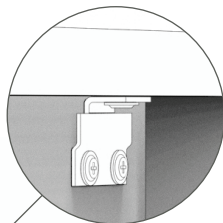
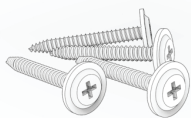

### PRODUCT FEATURES:

Efficient sound absorber due to the 50mm thick absorbent filling. Sturdy frame, and invisible wall fixing. Fabric and size can be customized if desired.

### MATERIALS:

Wood frame. 100% recycled polyester sound absorber. Fabric cover of your choice.

### PRODUCT INCLUDES:

Basic Wall sound absorber, 2 wall brackets and four screws.

### 1) CHOOSE POSITION

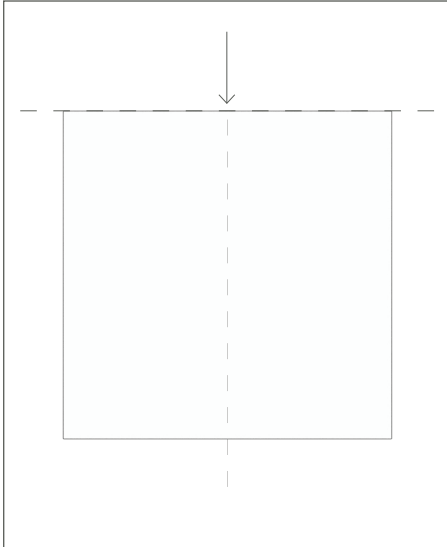

Decide where you want the top and center of your Basic Wall element to be.

### 2) POSITION THE WALL BRACKETS

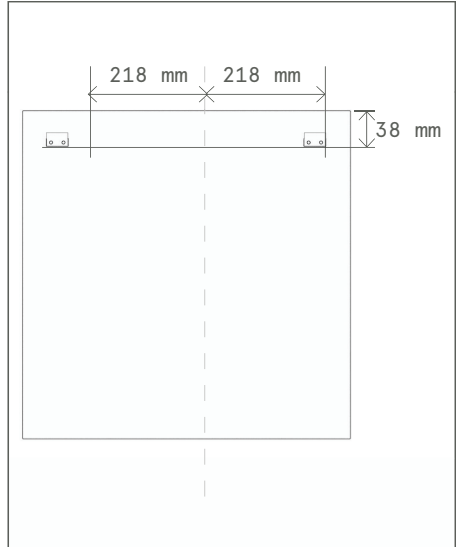

Measure out where to place the wall brackets from where the center and top should be.

### 3) ATTACH THE WALLBRACKETS

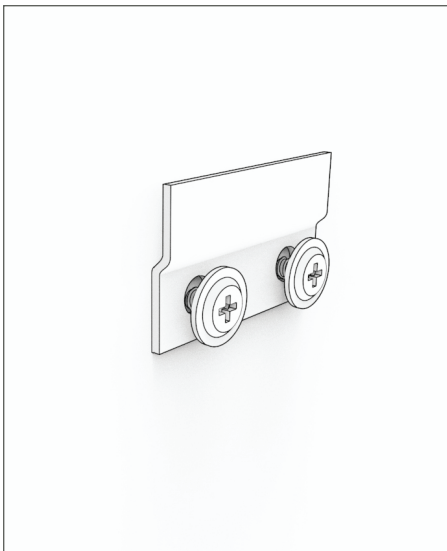

Attach the brackets to the wall with screws, but don't tighten the screws.

### 4) HOT TIP



Use a leveler to straighten out and align both wall brackets. Then tighten the screws.

### 5) HANG THE BASIC WALL ELEMENT



Place the BasicWall element a bit above the wall brackets, and slide it down into place.

### TIP ) POSITION OF WALL BRACKETS FOR ALL SIZES.

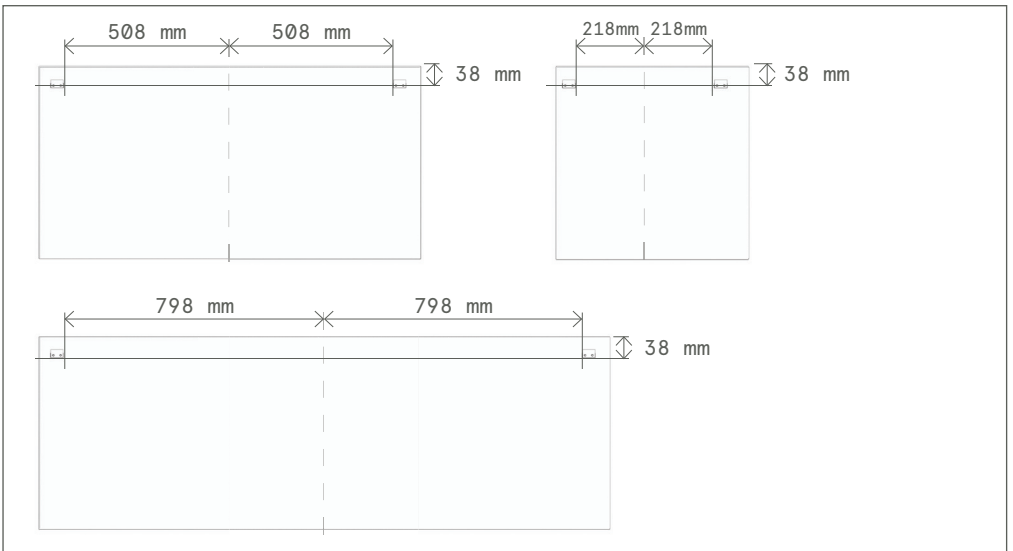

Depending on the size and orientation of each Basic Wall element, there are three alternative positions for the wall brackets. They are placed as described above.



**ROM & TONIK**

GOOD LOOKING SOUND ABSORBERS