



MODEL	FINISH
ZY6003	Chrome
	Brushed Nickel
	Glossy Black
	Oil Rubber Black
	Brown Bronze

Thank you for selecting our product for your home. Please read below instructions carefully before installing the new faucet.

BEFORE PROCEEDING

WARNING: A professional is recommended to install this product! This product should be installed in accordance with all local and state plumbing and building codes.

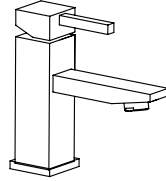

Single Basin Faucet
With Push up Pop-up Drain

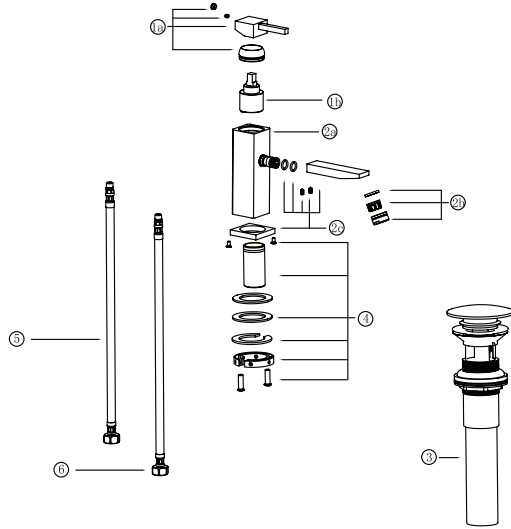

PARTS	NAME	QTY
1a	HANDLE	1
1b	CERAMIC CARTRIDGE	1
2a	BODY	1
2b	AERATOR ASSEMBLY	1
2c	BASE	1
3	PUSH UP POP-UP DRAIN	1
4	FIXED SYSTEM	1
5	FLEXIBLE HOSE	1
6	FLEXIBLE HOSE	1

TOOLS:



Adjustable Wrench



Screwdriver



Safety Goggles



Adjustable Wrench



Adjustable Wrench



Adjustable Wrench

MAINTENANCE:

Your new lavatory faucet is designed for years of trouble-free performance. Keep it looking new by cleaning it periodically with a soft cloth. Avoid abrasive cleaners, steel wool and harsh chemicals as they will dull the finish and influence your warranty.

FAUCET DIMENSION DRAWINGS:

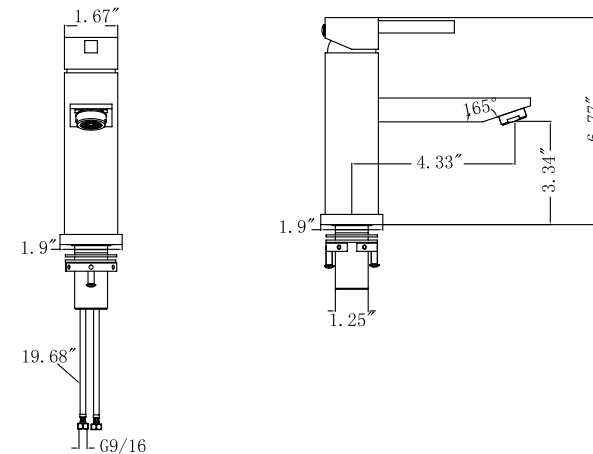

INSTALLATION

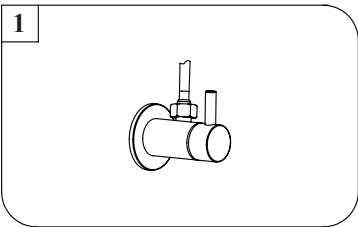

1. Shut off the hot and cold water supply under sink, Plug sink drain with cloth to avoid losing small parts, Remove old faucet.

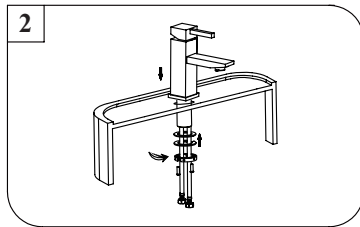

2. Insert the spout assembly into the hole. Install the plastic washer, metal washer, and the threaded ring. Position the screws to the front and back. Tighten the screws.

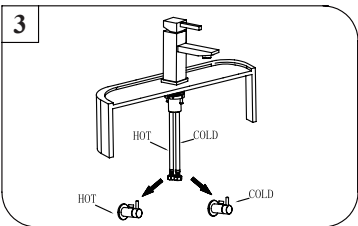

3. Connect and tighten the supply hose. Check for leaks.

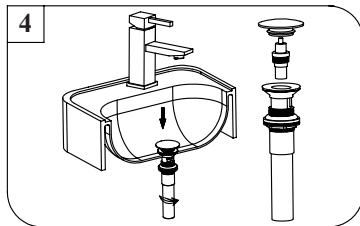

4. Install drain body up through the drain opening and reattach the flange onto drain body, holding the drain body in position with pivot rod opening facing the back of sink. Tighten the mounting nut by hand.

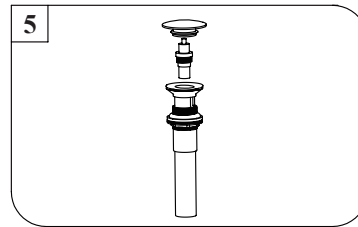

5. a. Remove Cap and Spring Mechanism by turning the cap counter clockwise.
b. If the cap comes off first, Hold the Spring Mechanism with pliers and gently turn counterclockwise to remove.
c. Clean drain body.

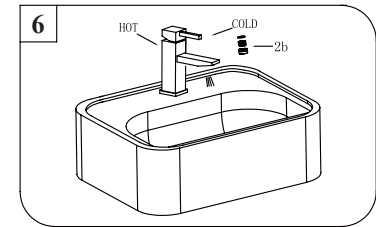

6. Remove AERATOR and turn faucet handles all the way on. Turn on hot and cold water supplies and flush water lines for one minute. Check all connections for leaks. Reinstall AERATOR. Your new faucet is now ready to use.

TROUBLE-SHOOTING:

If you have followed the instructions carefully and your faucet still does not work properly, take the following corrective steps:

PROBLEM	CAUSE	ACTION
Aerator drips or has inconsistent water flow pattern	Aerator may be dirty or not set properly	Unscrew aerator with aerator key and clean out debris
Drain is leaking	Washers may be compromised or installed incorrectly	Check washers to make sure they are installed correctly and not cracked