



MODEL	FINISH
ZY1003	Chrome
	Brushed Nickel
	Glossy Black
	Oil Rubber Black
	Brown Bronze

Thank you for selecting our product for your home. Please read below instructions carefully before installing the new faucet.

BEFORE PROCEEDING

WARNING: A professional is recommended to install this product! This product should be installed in accordance with all local and state plumbing and building codes.



Two Handle Lavatory Faucet With Push up Pop-up Drain

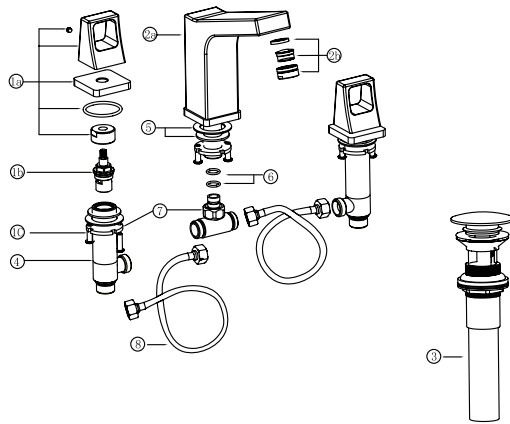

PARTS	NAME	QTY
1a	HANDLE	2
1b	CERAMIC CARTRIDGE	2
1c	VALVE BODY ASSEMBLY	2
2a	SPOUT	1
2b	AERATOR ASSEMBLY	1
3	PUSH UP POP-UP DRAIN	1
4	METAL WASHER	2
5	GASKET	1
6	O-RING	6
7	MOUNTING NUT	3
8	FLEXIBLE HOSE	1

TOOLS:

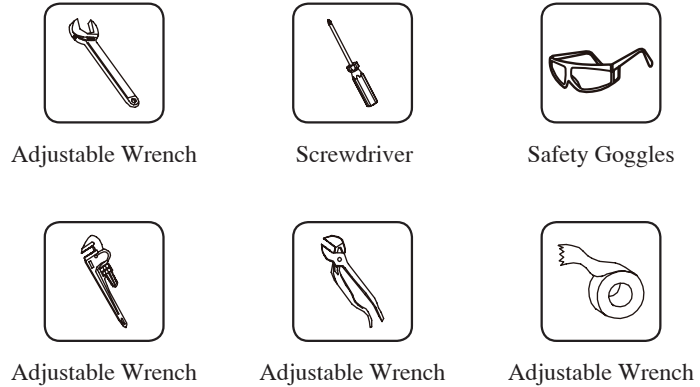

MAINTENANCE:

Your new lavatory faucet is designed for years of trouble-free performance. Keep it looking new by cleaning it periodically with a soft cloth. Avoid abrasive cleaners, steel wool and harsh chemicals as they will dull the finish and influence your warranty.

FAUCET DIMENSION DRAWINGS:

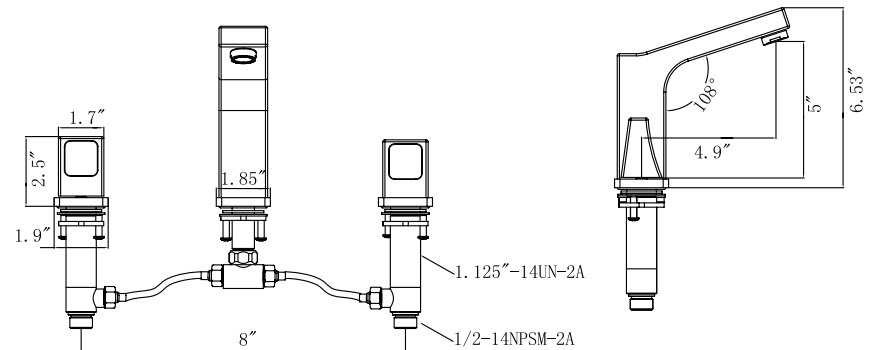

INSTALLATION

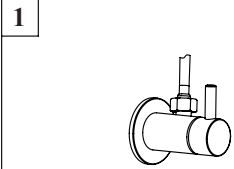

1. Shut off the hot and cold water supply under sink, Plug sink drain with cloth to avoid losing small parts, Remove old faucet.

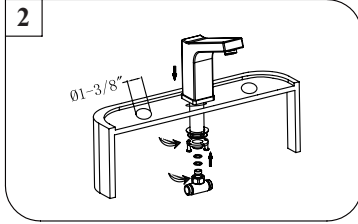

2. Place the spout into center hole (The hole diameter should be 1-3/8") of the sink. Under sink, secure firmly to sink with rubber washer, metal washer and mounting nut.

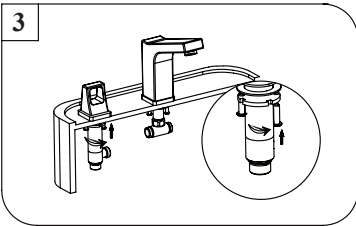

3. Insert the Valve body assembly with the hot supply label is on the left (hot) side. Hold the body in the proper position. Assemble metal washer and mounting nut onto body underside of sink, tighten it with the locking screws.

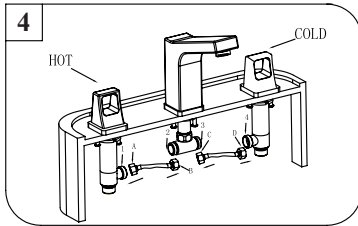

4. Connect and tighten the hoses

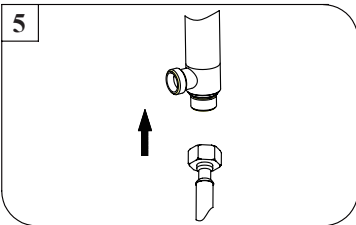

5. Stainless steel braided faucet supply tubes : This is the simplest of all installations. If you are using stainless steel braided faucet supply tubes, this faucet requires one end of the supply tube to have a 1/2" female IPS connection. The other end of this supply tube must match the thread on the water supply fittings or shut off valve under your sink. Once you have identified the required tube, carefully follow the manufacturer's installation instructions for each tube.

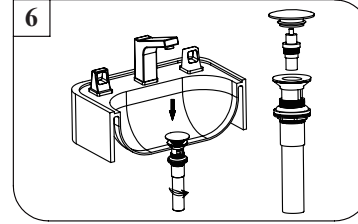

6. Install drain body up through the drain opening and reattach the flange onto drain body, holding the drain body in position with pivot rod opening facing the back of sink. Tighten the mounting nut by hand.

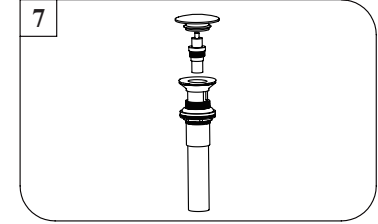

7. a. Remove Cap and Spring Mechanism by turning the cap counter clockwise.
b. If the cap comes off first, Hold the Spring Mechanism with pliers and gently turn counterclockwise to remove.
c. Clean drain body.

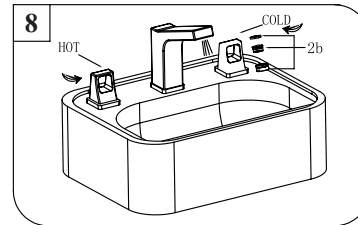

8. Remove AERATOR and turn faucet handles all the way on. Turn on hot and cold water supplies and flush water lines for one minute. Check all connections for leaks. Reinstall AERATOR. Your new faucet is now ready to use.

TROUBLE-SHOOTING:

If you have followed the instructions carefully and your faucet still does not work properly, take the following corrective steps:

PROBLEM	CAUSE	ACTION
Aerator drips or has inconsistent water flow pattern	Aerator may be dirty or not set properly	Unscrew aerator with aerator key and clean out debris
Drain is leaking	Washers may be compromised or installed incorrectly	Check washers to make sure they are installed correctly and not cracked