

SINK BASE
WT9309-30

VANITY CABINET + VANITY TOP

VANITY SET: WT9309-30

INSTALLATION INSTRUCTIONS



PRODUCT PACKAGE COMPONENTS/TOOLS REQUIRED

VANITY COMBINATION MAIN COMPONENTS



Glass Basin **x 1**

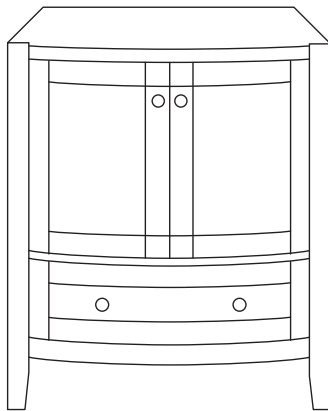

Vanity Base Cabinet **x 1**

INSTALLATION ACCESSORIES

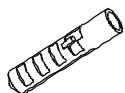

x 2

Wall Anchors



x 2

Screws 1 1/4"

P-TRAP AND POP AND POP-UP INSTALLATION DIAGRAM

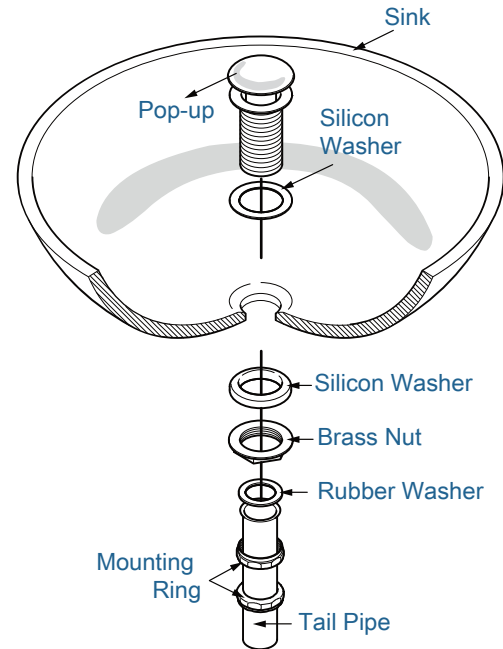

TOOLS REQUIRED FOR INSTALLATION (NOT INCLUDED)



Safety Glass

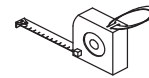

Tape Measure

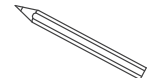

Pencil/Marker



Silicone

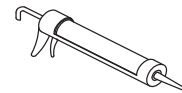

Caulk Gun

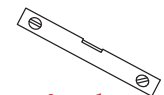

Level



Soft Cloth
or Blanket



Pliers



Electric Drill
with DrillBits



Phillips
Screwdriver



Stud Finder



Hammer

Other tools may be required



DIMENSIONS & SPECIFICATIONS

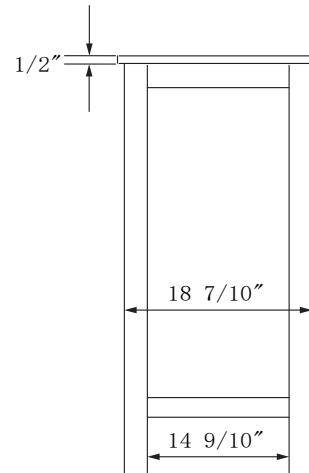
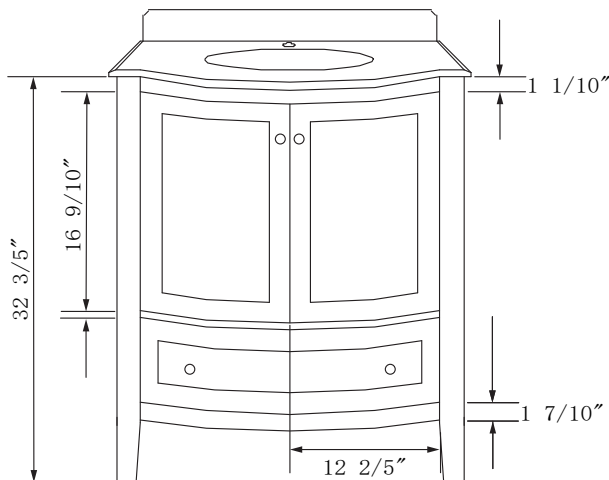
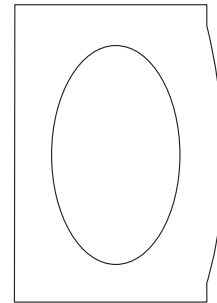
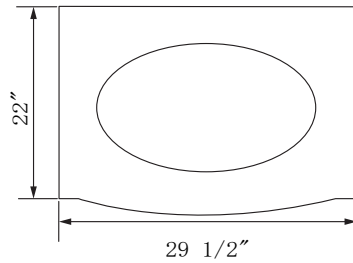

Front View

Side View

ATTENTION! Due to manufacturing process any dimensions may have a tolerance up to 3/8". All sizes are for reference only. It is highly recommended to pull all dimensions of actual model for installation and measuring purposes.

ATTENTION! If two or more vanity cabinets are installed next to each other there will be a visible seam between vanity tops and between vanity cabinets or between drawer base cabinets.

**INSTALLATION STEPS****INSTALL DOOR & DRAWER HANDLES**

All WT9309-30 vanity cabinets by LegionFurniture come pre-assembled. All door and drawer handles are installed from the inner side of the drawer to avoid damage during transportation. Open the drawers to install the handles. Unscrew every handle and install them from the outer side of the doors and drawers. **See Figure 1**

Note: It is highly recommended not to use electric drill to avoid overtightening the screws during handle installation.

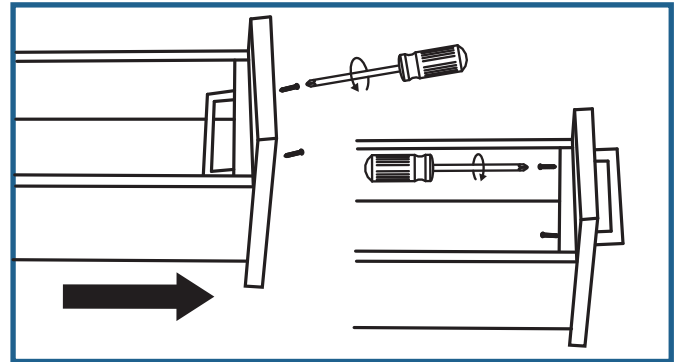

See Figure 1

VANITY CABINET ASSEMBLY

Prior to installation of the glass vanity top you must apply a silicone layer by a perimeter of the vanity base cabinet and carefully lay down the vanity top on top of the vanity cabinet.

See Figure 2

Note (single vanity sink cabinet installation): Vanity top is slightly wider than the actual cabinet. Make sure that outstanding edges are equal at left and right sides.

Apply a silicone layer on the back side of the vanity top that will be adjacent to the wall.

Allow the silicone dry for 48 hours prior to the first use of the vanity cabinet.

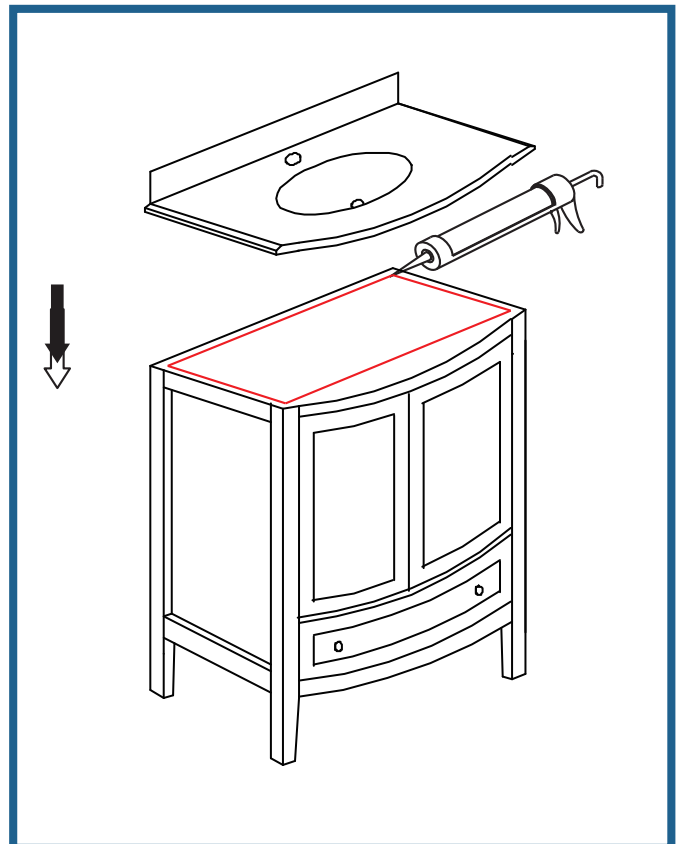

See Figure 2



VANITY CABINET + VANITY TOP

VANITY SET:WT9309-30

Retain these installation instructions
for future reference!

Legionfurniture reserves the right to modify this installation instructions at any time.
It is a customer's sole responsibility to inquiry for the updates of the installation instructions.