

Installation Instructions for LED Medicine Cabinet

Note: To ensure general use of this product please follow the installation instructions carefully. Must be installed indoors and on a suitable load bearing wall. Installation should be done by a licensed contractor and/or electrician. Only a clean soft cloth should be used to clean this product.

Installation Tools Needed

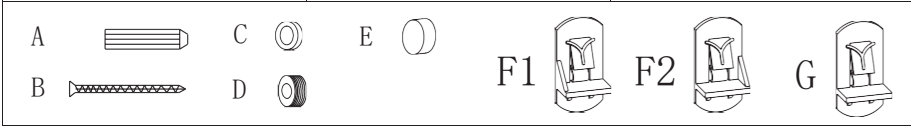
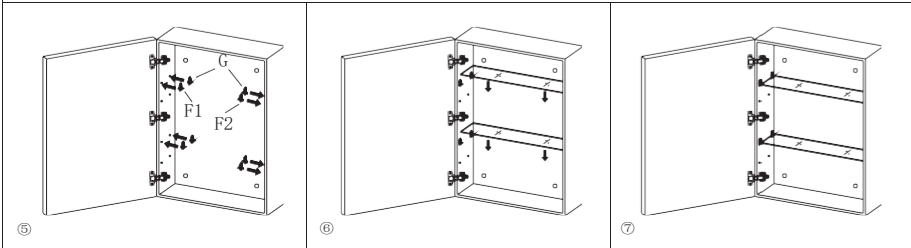
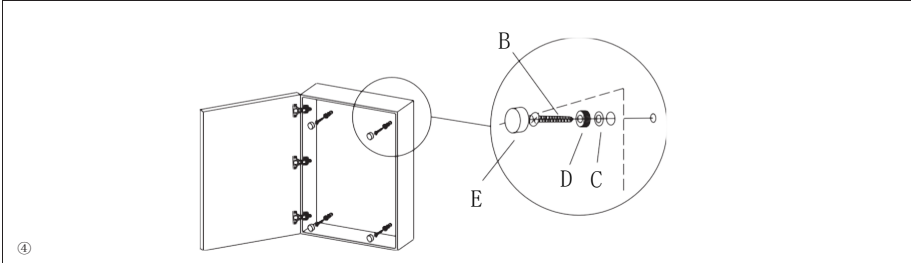
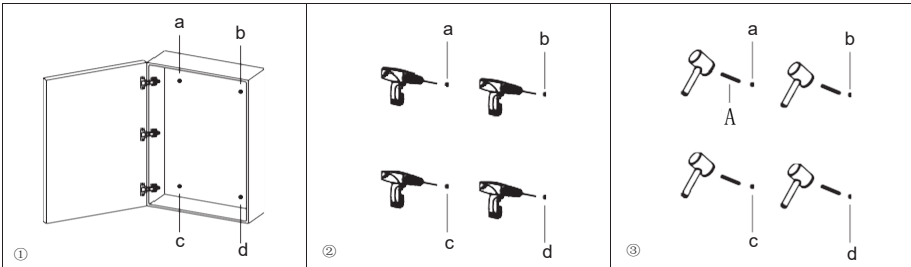
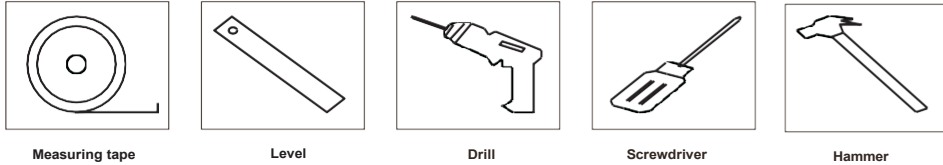

Installation Instructions:

- Fig①: Position the cabinet, mark the a/b/c/d mounting holes from inside onto the wall.
- Fig②: Use the marks to pre-drill holes.
- Fig③: Hammer "A" anchors into the pre-drilled holes.
- Fig④: Hold the mirror cabinet and install mounting hardware "B", "C", "D", and "E" as shown in the illustration.
- Fig⑤: Insert the provided shelf clips (F1/F2/G) into the round holes on both sides of the cabinet.
- Fig⑥: After installing the shelf clips, insert the glass shelf(s).

Wiring diagram for input terminal:

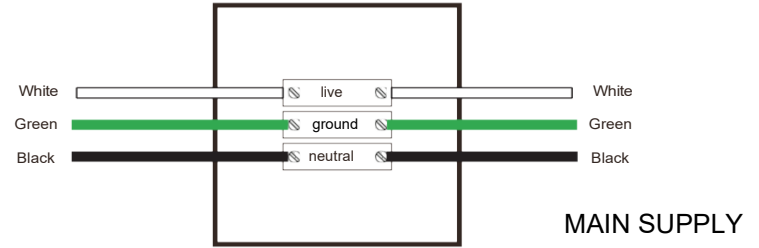

Electronic Diagram

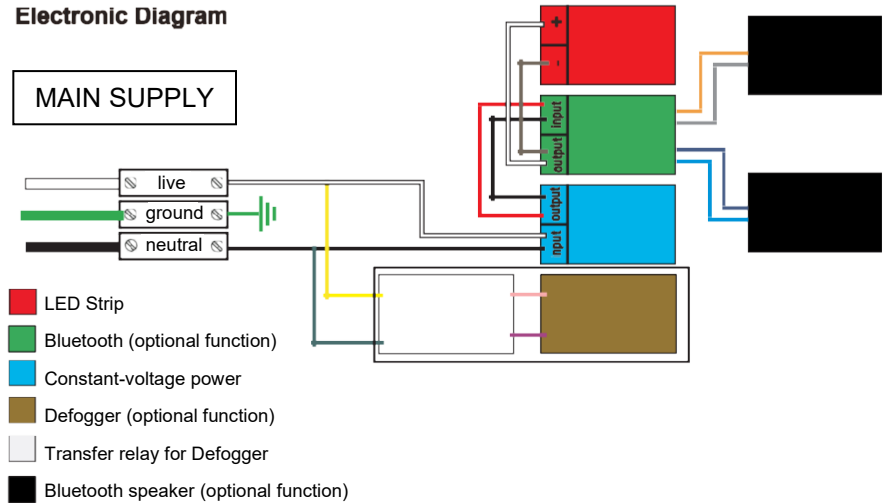

CAUTION:

During operation of this product, never use hard or sharp objects directly against the mirror surface, as it may result in damage and/or personal injury. Clean the product with a soft cloth and mild detergent only. Do not use abrasives, chemical cleaners, or leave any solutions on the surface such as soup, shampoo, etc. as they may damage the mirror.

Bluetooth Function of LED Medicine Cabinet

SCREEN DISPLAY AND TOUCH BUTTONS

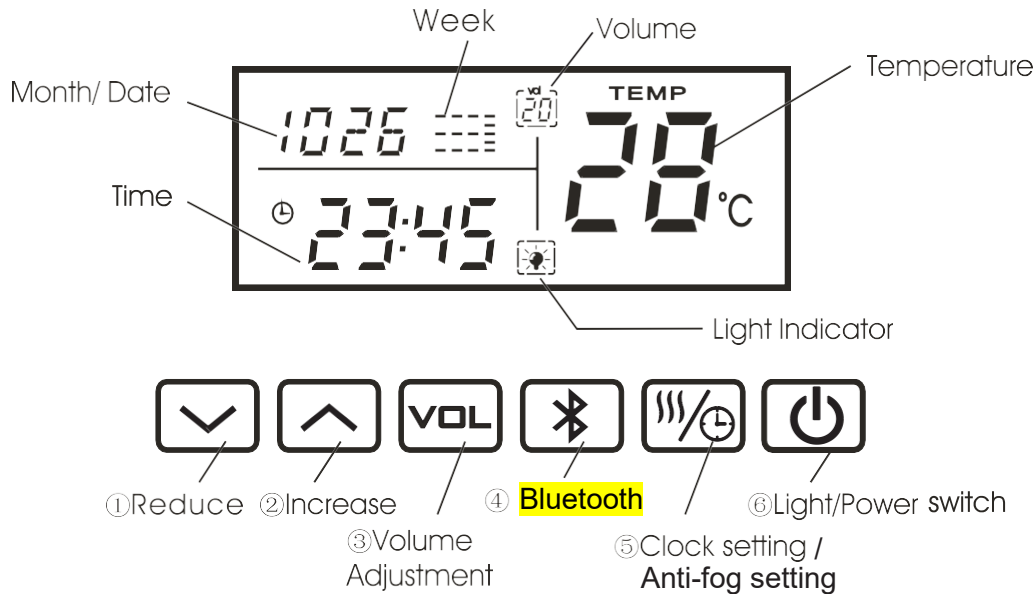

FUNCTION AND BUTTON INSTRUCTIONS

Display:

- (1) The screen and buttons will have an automatic backlit display while powered on.
- (2) Press button ⑥ to control the lights on and off while the product is powered on, the light symbol  will show on the screen while the lights are on.
- (3) Press button ⑥ to power on. Hold button ⑥ for 3 seconds to power off.

Time and Date Settings:

- (1) When the power is on, press button ⑤ to control the anti-fog function on or off, the anti-fog symbol will appear/disappear on the screen when the function is on/off. (The anti-fog function will turn off automatically after running for 65 minutes.)
- (2) Press ⑤ for 3 seconds to start Time and Date setting function, you will see the Hour number flashing when the time and date are ready to be changed. By pressing button ⑤ you can change between the Hour, Minute, Month, Day and Year numbers. Press button ① to reduce or button ② to increase the numbers while they are flashing.

NOTE: Bluetooth function must be disabled before changing settings.

Connecting the Bluetooth

- (1) To connect to Bluetooth press button ④ to open the Bluetooth function. The device is ready to connect when the screen displays "1-bt" and makes a beep sound.
- (2) Next search and connect to "K3015C" from your smart device.
- (3) Bluetooth connection is successful when the "1-bt" on the screen stops flashing. Now you are ready to play your music.

NOTE: The Bluetooth function of this product supports connecting up to two devices at the same time, but one device will be automatically paused when the other device is playing.

Bluetooth Functions

- (1) To skip songs press buttons ① to return to the last song and press button ② to skip to the next song
- (2) To adjust the volume press button ③ to select the volume setting. Once the volume on the screen starts flashing press button ① to reduce the volume and press button ② to increase the volume.
- (3) Press button ④ to disconnect the Bluetooth function

- Keep this product away from strong magnetic fields, electrical fields and heated appliances.
- For the best connection keep your smart device within 6-12 feet from this product without any obstructions. such as walls or other electrical equipment.
- After disconnecting, the Bluetooth signal will not automatically reconnect.