

1 Place cabinet (D) in the designated location and mark bracket position on the wall.

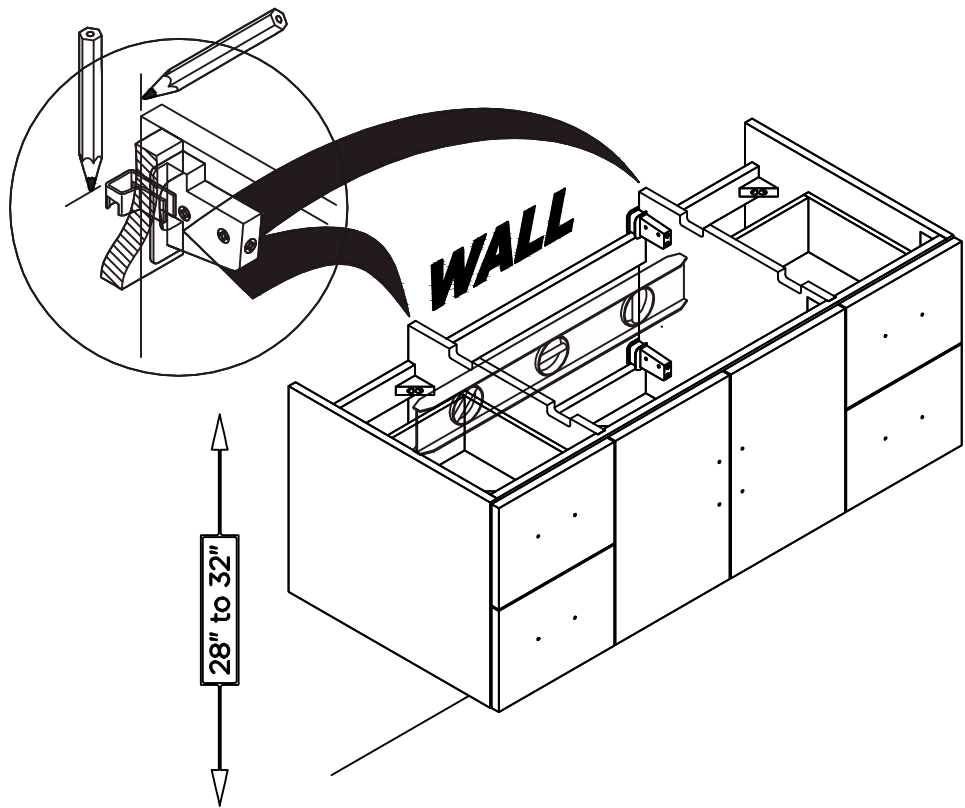

2 Attach the wall brackets (E) to the wall with the screws (F).

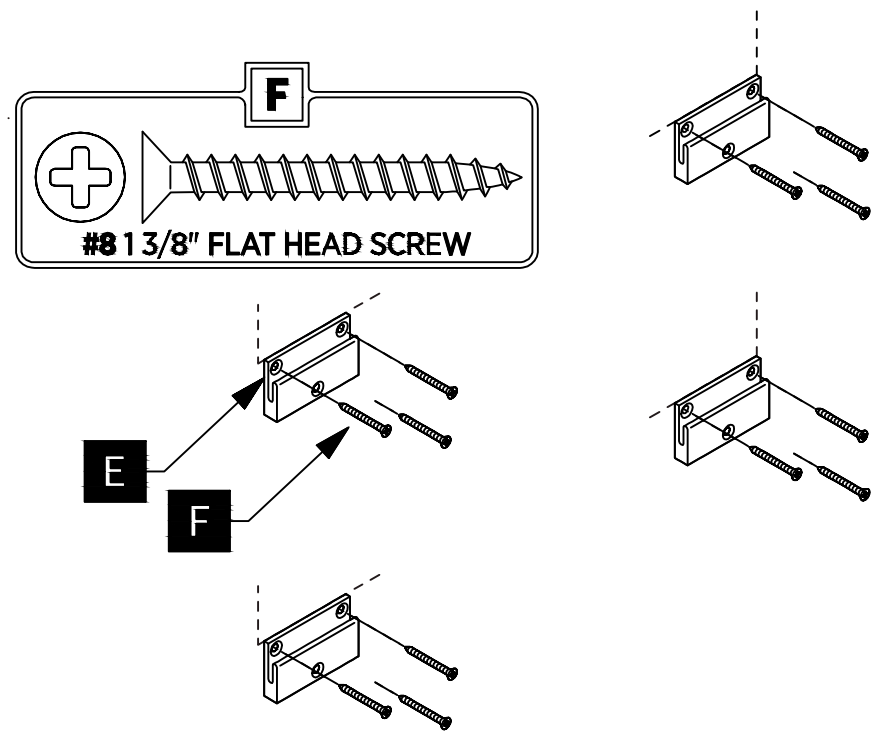

IMPORTANT: Consult an expert for the proper screws/bolts to use when attaching to various constructions. Screws provided do not attach to all wall construction types. Anchors are not required if brackets are installed in stud.

3 Apply a bead of silicone and hang the cabinet (D) on the brackets.

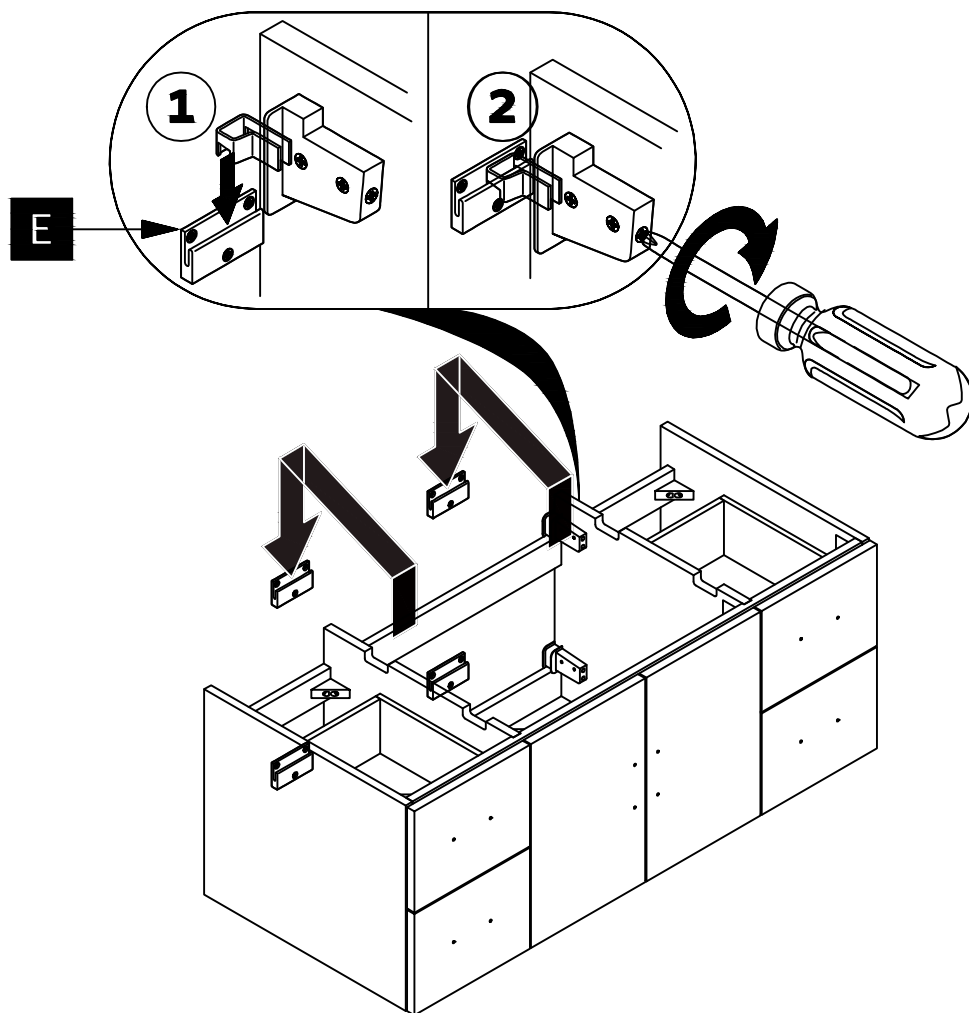

4 Attach the handles to the cabinet.

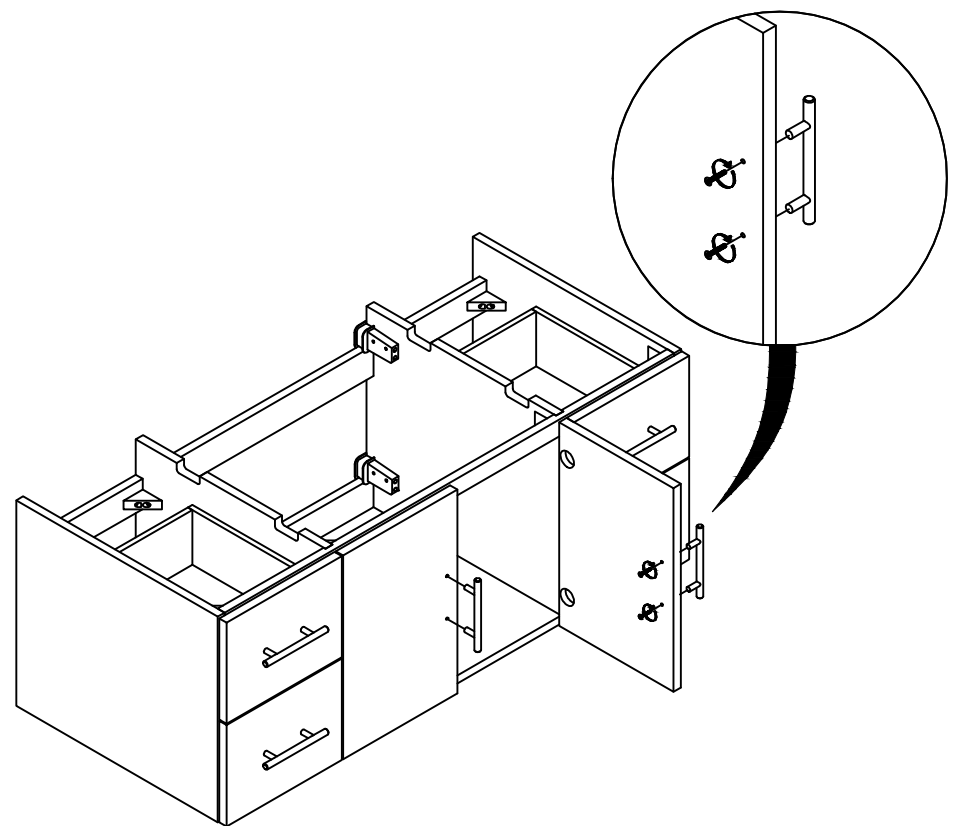

5 Put a bead of silicone on the top of the cabinet (G) then place sink (H) on the top of it.

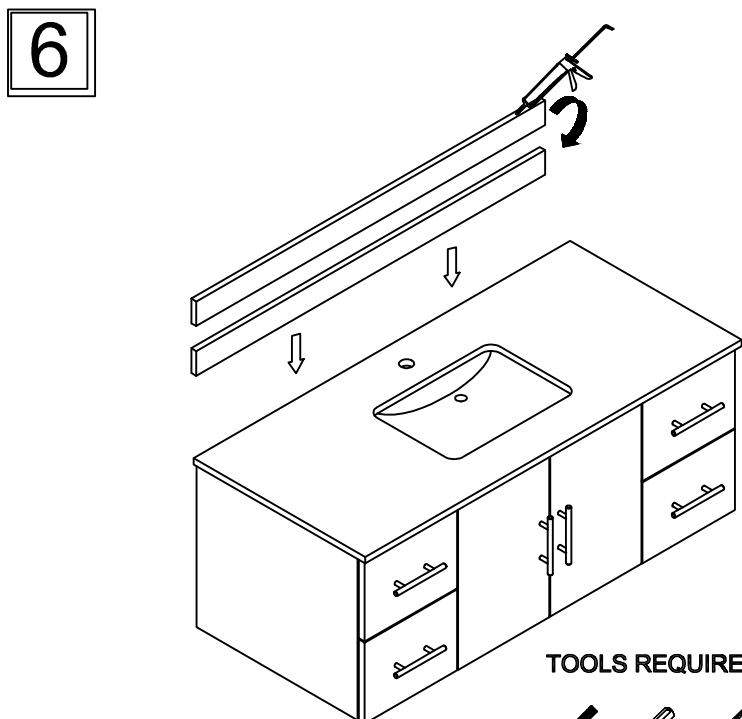
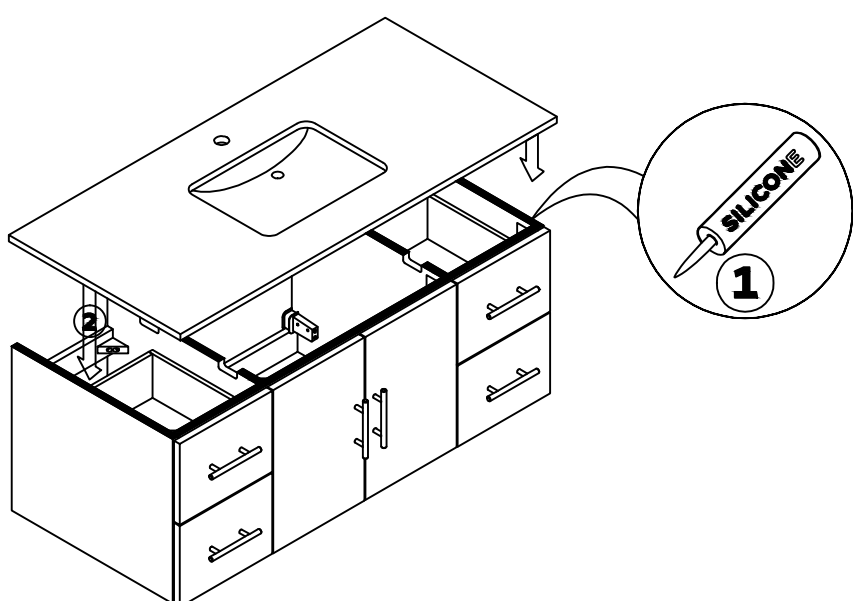

TOOLS REQUIRED (not supplied)

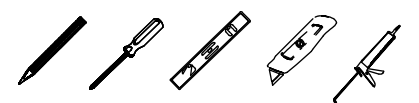

7

Silicone

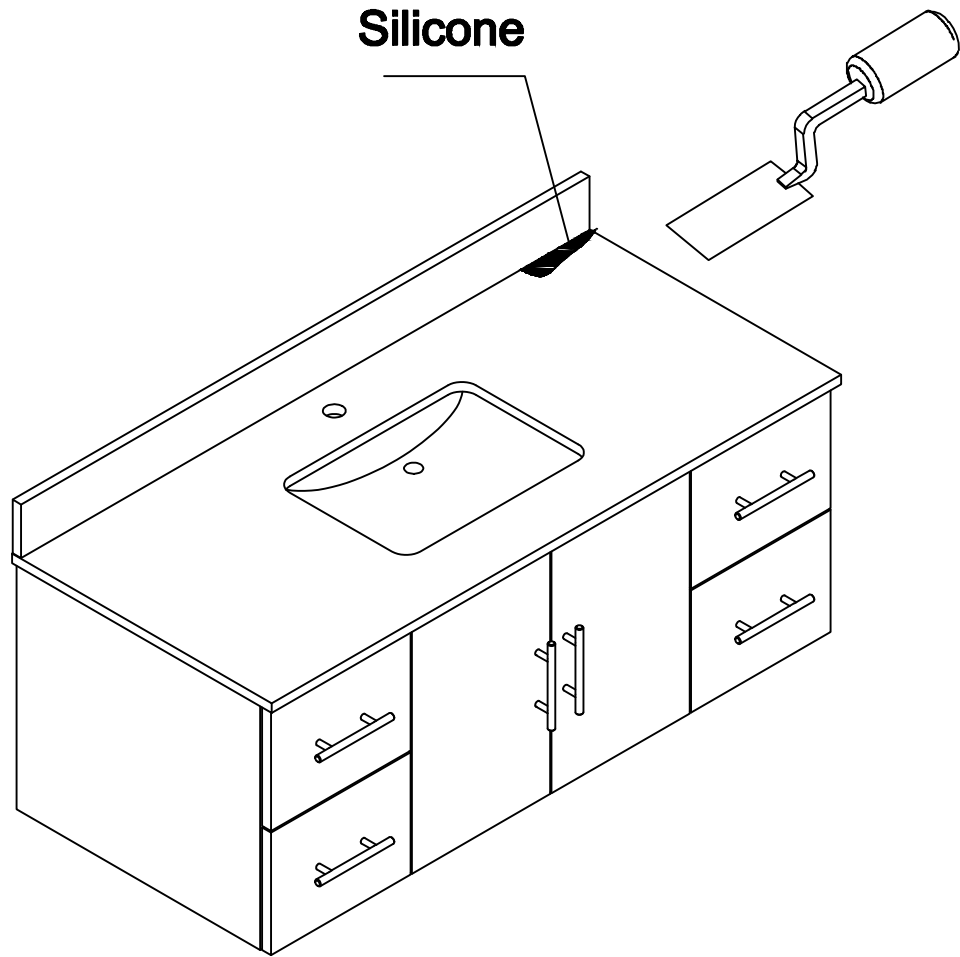

INSTALLATION

8

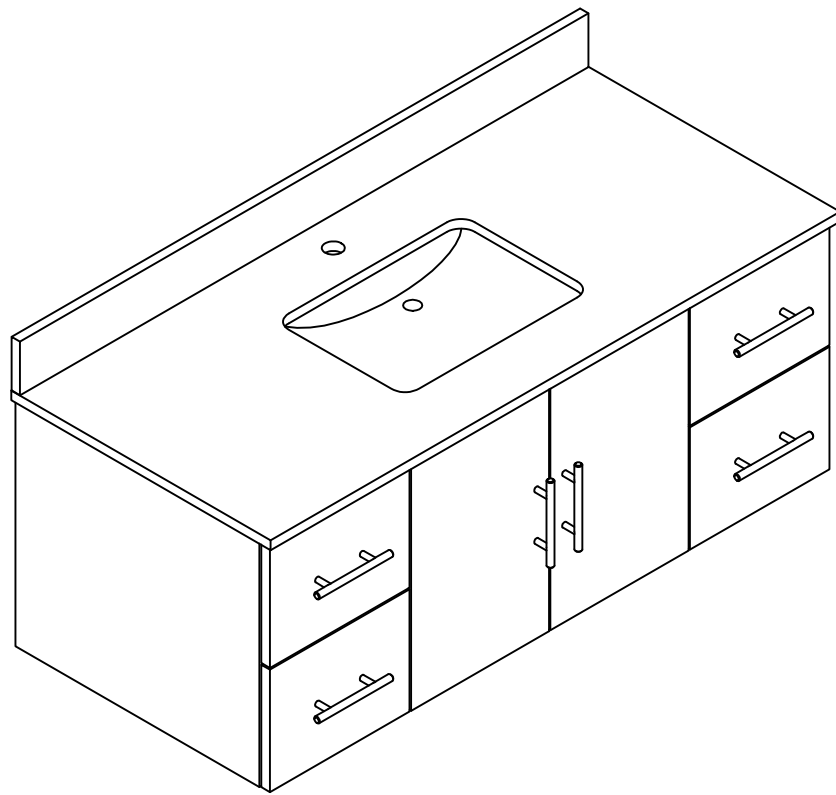

INSTALLATION

9

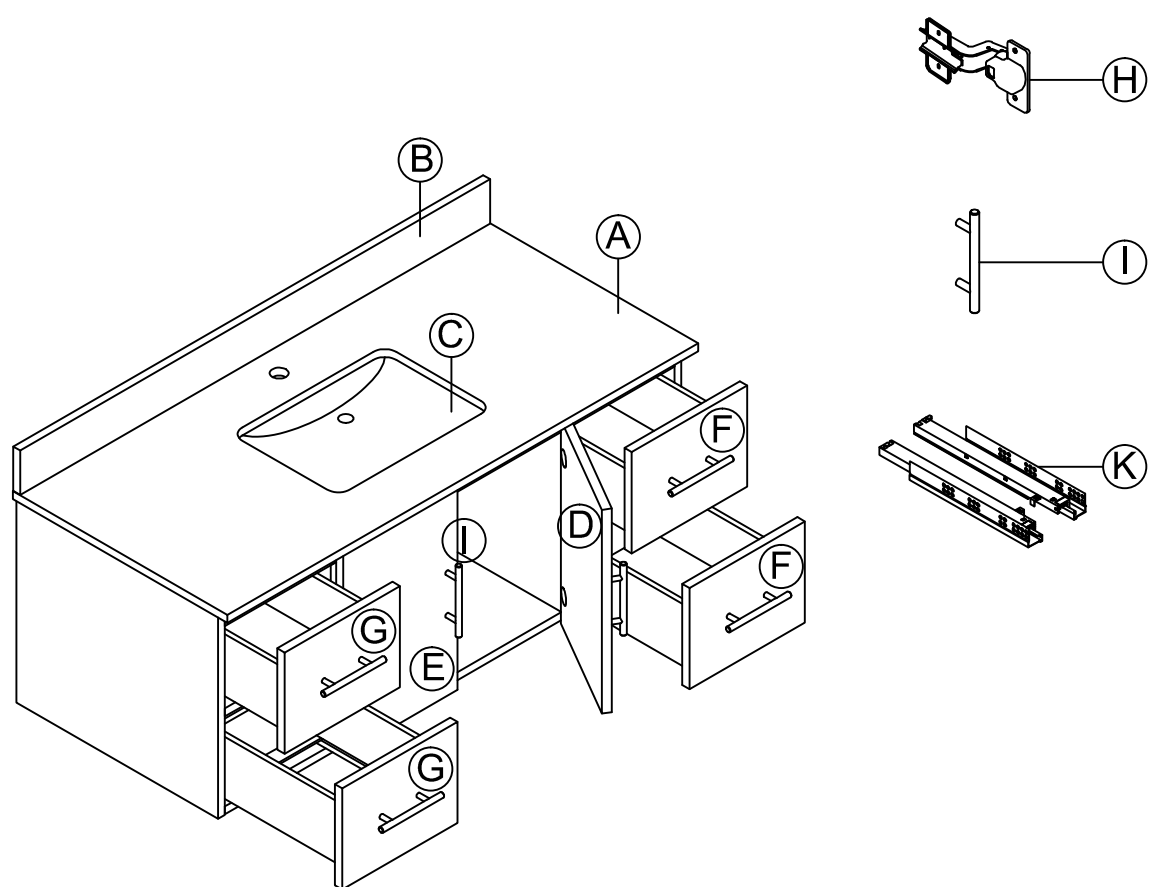

PART#	DESCRIPTION	QUANTITY
A	Countertop	1
B	Backsplash	1
C	Basin	1
D	Door (right)	1
E	Door (left)	1
F	Drawer	4
H	Hinge (door)	4
I	handle	6
K	Drawer glides	4

PART LIST

REMOVE

INSTALL

1

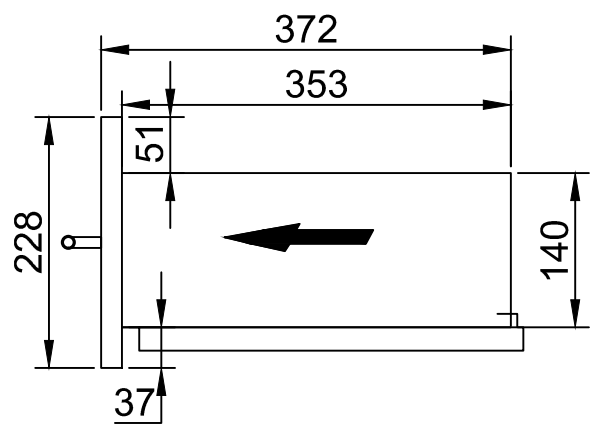

1

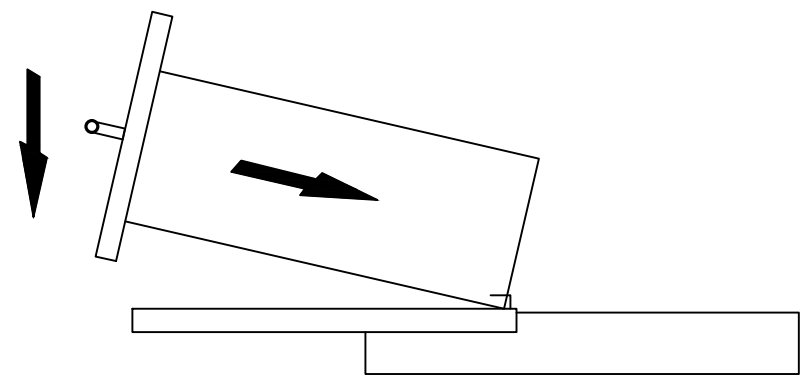

2

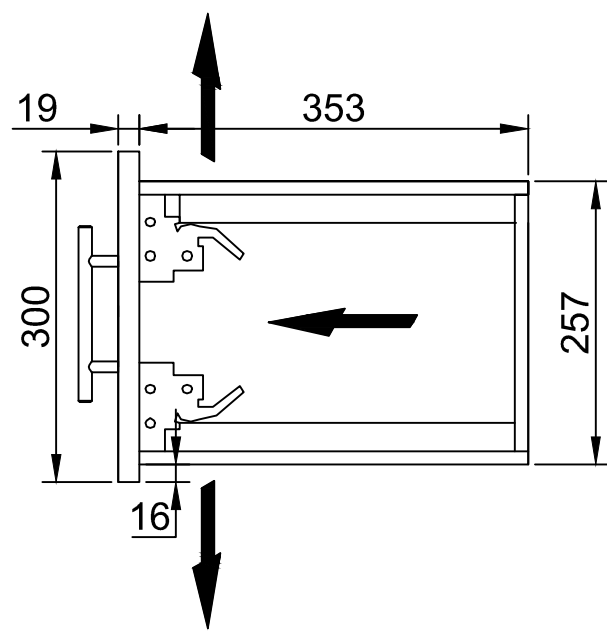

2

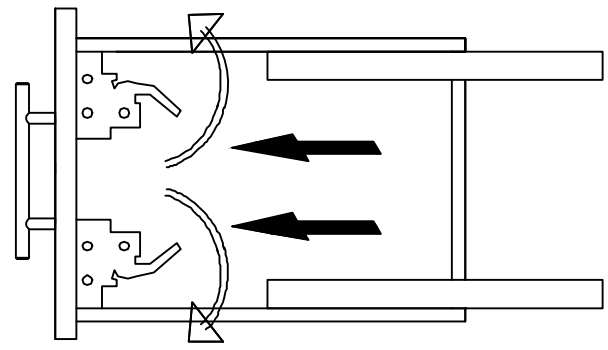

3

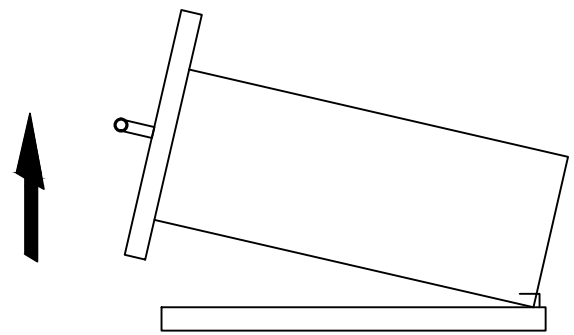

3

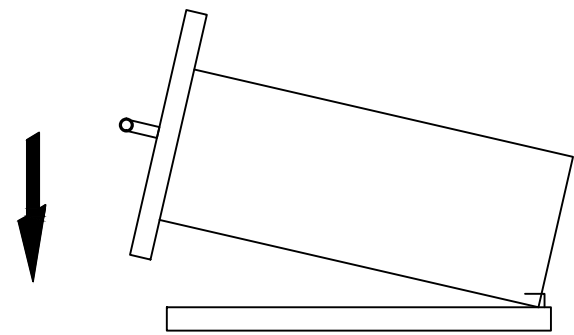

4

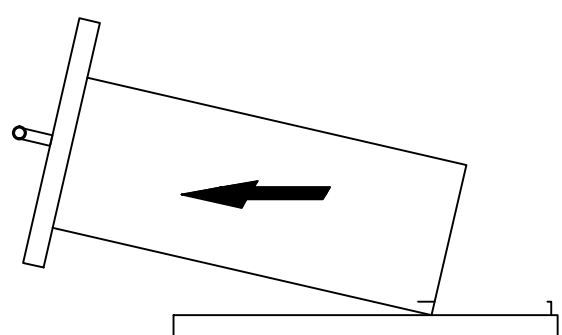

4

