

# BELLATERRA HOME

**Model: 203145**

## Tools List (Not included)



Tape Measure



Pencil



Electric Drill



Drill Bit

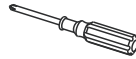

Screwdriver

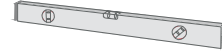

Spirit Level



Silicone

## Parts List (Included)



Screw  
(2pcs)



Anchor  
(2pcs)



Foam pad  
(4pcs)

Mark the position of the screw holes on the wall by measuring the space between the mounting brackets on the back of the vanity. Vertical position (X) is decided by the user, remember to mark low enough to accommodate the sink on the top of the vanity counter or it will be too high when installed. Use a spirit level to ensure the screws holes are in line.

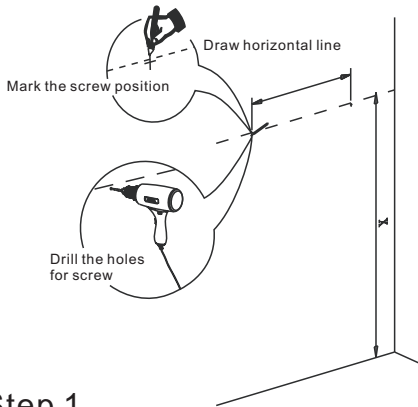

**Step 1**

Insert the anchor into the screw hole for reinforcement.

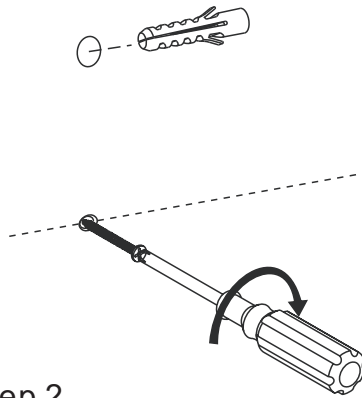

**Step 2**

Attach the vanity to the wall by lowering the bracket onto the screws.

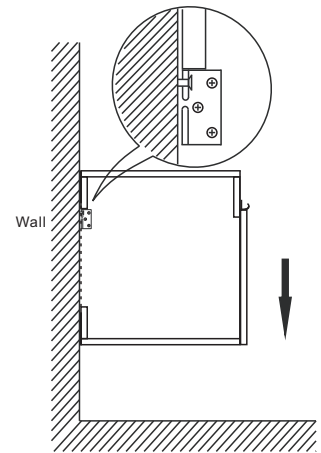

**Step 3**

Use a spirit level to ensure the vanity is level from left to right and front to back, adjust if needed.

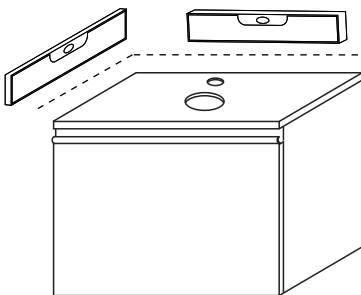

**Step 4**

Put the integrated ceramic sink on the top of vanity, and check if it stay firm on the vanity. If the ceramic sink is not staying firm on the vanity, please use the foam pad to fill the gap.

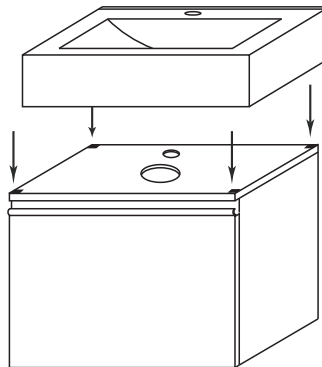

**Step 5**

Finally, place the ceramic sink again to check the stability.

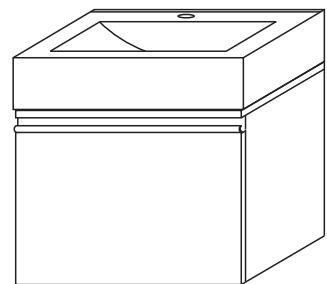

**Step 6**

### INSTALLATION TIPS:

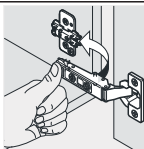

install

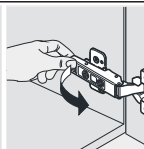

remove

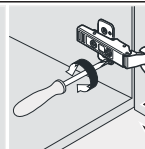

adjust the height

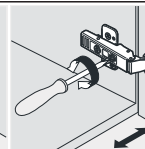

adjust the lateral

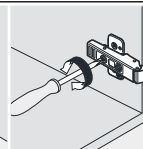

adjust the deep

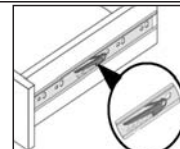

press down the pin on this side & press up the one on another side to pull out the drawer box.

**NOTE: SINK STYLE, SHAPE, FAUCET HOLES, CUTOUT ON TOP, VANITY MAY VARY FROM THE PICTURE ABOVE. INSTRUCTIONAL PURPOSE ONLY.**

Professional installation is recommended.  
www.bellaterra-home.com

Bellaterra Home LLC, All Rights Reserved 2015