



PFS Report # 11-083

**Installation and Operating Instructions for Unvented Gas Log Heater
EWCL18NV and PV
EWCL2430NV and PV**
For use with Cumberland Log Sets only

ANSI Z21.11 2-2016 APPROVED / ANSI Z21.60-2017 CSA 2.26 2017

State and local codes may only allow operation of this appliance in a vented configuration. Check your local and state codes.

WARNING: FAILURE TO FOLLOW THESE INSTRUCTIONS CAREFULLY AND WITHOUT ERROR OR FAILURE TO HEED ANY AND ALL WARNINGS IN THESE INSTRUCTIONS CAN RESULT IN AN EXPLOSION, FIRE OR THE PRODUCTION OF CARBON MONOXIDE GAS WHICH CAN CAUSE PROPERTY DAMAGE, BODILY INJURY OR DEATH.

WARNING

If the information in this manual is not followed exactly, a fire or explosion may result, causing property damage, personal injury or loss of life.

Do not store or use gasoline or other flammable vapors and liquids in the vicinity of this or any other appliance.

WHAT TO DO IF YOU SMELL GAS:

- Do not try to light any appliance.
- Do not touch any electrical switch.
- Do not use any telephone in your building.
- Immediately call your gas supplier from a neighbor's telephone.
- Follow the gas supplier's instructions.
- If you cannot reach your gas supplier, call the fire department.

Installation and service must be performed by a qualified installer, service agency or the gas supplier.

This is an unvented gas-fired heater. It uses air (oxygen) from the room in which it is installed. Provisions for adequate combustion and ventilation air must be provided. Refer to page 4.

This appliance is intended for supplemental heating.

This appliance may be installed in an aftermarket, permanently located, manufactured (mobile) home, where not prohibited by local codes. This appliance is only for use with the type of gas indicated on the rating plate.

IMPORTANT: READ INSTRUCTIONS CAREFULLY BEFORE BEGINNING INSTALLATION OF THIS ROOM HEATER.

INSTALLER: Leave this manual with the appliance.
CONSUMER: Retain this manual for future reference.

WARNING

- Any change to this heater or its controls can be dangerous and void any warranty.
- Do not allow fans to blow directly into fireplace. Avoid drafts that alter burner flame patterns.
- Do not use a blower insert, heat exchanger insert or any other accessory not approved for use with this heater.
- Improper installation or use of this heater can cause serious injury or death from fire, burns, explosion or carbon monoxide poisoning.

Children and adults should be alerted to the hazard of high surface temperature and should stay away to avoid burns or clothing ignition.

1. Due to high temperatures, the heater should be located out of traffic and away from furniture and draperies.
2. Children and adults should be alerted to the hazard of high surface temperature and should stay away to avoid burns or clothing ignition.
3. Young children should be carefully supervised when they are in the same room as the heater.
4. Do not place clothing or other flammable material near the fireplace when the heater is in use.
5. Any safety screen or guard removed for servicing must be replaced prior to operating the heater.
6. Installation and repair should be done by a qualified service person.
7. To prevent malfunction and/or sooting, an unvented gas heater should be cleaned at least annually by a professional service person. More frequent cleaning may be required due to excessive lint from carpeting, etc. It is imperative that control compartments, burners and circulating air passageways be kept clean.
8. **CARBON MONOXIDE POISONING:** Early signs of carbon monoxide poisoning are similar to the flu with headaches, dizziness and/or nausea. If you have these signs, obtain fresh air immediately. Have the heater serviced as it may not be operating properly.
9. The installation must conform with local codes or, in the absence of local codes, with the National Fuel Gas Code, ANSI Z223.1/NFPA54./
10. This unit complies with ANSI Z21.11.2-2016 Unvented heaters and also complies with ANSI Z21.60-2017 Decorative Vented appliances for Solid Fuel Burning fireplaces. State and local codes may only allow operation of this appliance in a vented configuration. Check your state or local codes. For vented operation, see “Vented Instructions” in this manual.
11. Do not install the heater in a bedroom or bathroom.
12. Correct installation of the logs, proper location of the heater and annual cleaning are necessary to avoid potential problems with sooting. Sooting, resulting from improper installation or operation, can settle on surfaces outside the fireplace. See log placement instructions for proper installation.
13. Avoid any drafts that alter burner flame patterns. Do not allow fans to blow directly into the fireplace. Do not place a blower inside burn area of the firebox. Ceiling fans may create drafts that alter burner flame patterns. Sooting and improper burning will occur.
14. This is an unvented Gas-fired heater. It uses air (oxygen) from the room in which it is installed. Provisions for adequate combustion and ventilation air must be provided. Refer to installation guidelines.
15. Keep appliance area clear and free from combustible materials, gasoline and other flammable vapors and liquids.

Important safety information cont

Do not use this room heater if any part has been under water. Immediately call a qualified service technician to inspect the room heater and to replace any part on the control system and any gas control which has been underwater.

This room heater is for installation in a solid fuel burning fireplace or listed unvented firebox enclosure only.

A fireplace screen must be in place when the appliance is operating and, unless other provisions for combustion air are provided, the screen shall have an opening (s) for introduction of combustion air.

Any glass door should be fully opened when the appliance is in operation.

WARNING

*This appliance is equipped for (natural or Propane) gas.
Field conversion is not permitted.*

Solid fuels shall not be burned in a fireplace in which an unvented room heater is installed.

Any outside air ducts and/or ash dumps in the fireplace should be permanently closed at time of appliance installation.

Clearances around air openings of fireplace must be kept clear. Do not stack anything in front of air vents or fireplace openings.

WARNING

This appliance is for installation only in a solid fuel burning masonry or UL 127 Factory-built fireplace or in a listed unvented firebox enclosure. It has been design certified for these installations. Exception: DO NOT install this appliance in a factory-built fireplace that includes instructions stating it has not been tested or should not be used with unvented gas logs.

The installation of appliances designed for manufactured home or mobile home installation must conform with *Manufactured Home Construction and Safety Standard, Title 24 CFR, Part 3280*, in the United States, or when such standard is not applicable, ANSI/NCSBCS A225.1/NFPA 501A, *Manufactured Home Installations Standard*.

PRODUCT SPECIFICATIONS

MINIMUM SIZE FIREPLACE DIMENSIONS

Gas Log Size Dimension → ↓	18"	24"	30"
Height of Front Opening	15"	15"	15"
Width of Front Opening	21 1/2"	26 1/2"	35 1/2"
Depth	14"	14"	14"
Width of Rear Opening	16"	21"	25"

BTU'S RATING

BTU Ratings	18"	24"/30"
LP	33,000	40,000
NAT	34,000	40,000

General Instructions

PROVISIONS FOR ADEQUATE COMBUSTION AND VENTILATION AIR

This heater shall not be installed in a confined space or unusually tight construction unless provisions are provided for adequate combustion and ventilation air.

The National Fuel Gas Code ANSI Z223.1/NFPA54 defines a confined space as a space whose volume is less than 50 cubic feet per 1,000 Btu per hour (4.8m³ per kw) of the aggregate input rating of all appliances installed in that space and an unconfined space as a space whose volume is not less than 50 cubic feet per 1,000 Btu per hour (4.8m³ per kw) of the aggregate input rating of all appliances installed in that space. Rooms communicating directly with the space in which the appliances are installed, through openings not furnished with doors, are considered a part of the unconfined space.

Unusually tight construction is defined as construction where:

- a) Walls and ceiling exposed to the outside atmosphere have a continuous water vapor retarder with a rating of 1 perm (6 x 10⁻¹¹ kg per-pa-sec-m²) or less with openings gasketed or sealed, and
- b) Weather stripping has been added on openable windows and doors, and
- c) Caulking or sealant are applied to areas such as joints around windows and door frames, between sole plates and floors, between wall-ceiling joints, between wall panels, at penetrations for plumbing, electrical, and gas lines, and at other openings.

WARNING

If the area in which the heater may be operated is smaller than that defined as an unconfined space or if the building is of unusually tight construction, provide adequate combustion and ventilation air by one of the methods described in the "National Fuel Gas Code, ANSI Z223.1/NFPA 54, the international Fuel Gas Code" or applicable local codes.

If the area in which the heater may be operated does not meet the required volume for indoor combustion air, combustion and ventilation air shall be provided by one of the methods described in the "National Fuel Gas Code, ANSI Z223.1/NFPA 54, the international Fuel Gas Code" or applicable local codes.

General Installation Information

The following formula can be used to determine the maximum heater rating per the definition of confined space:

$$BTU/HR = \frac{(L_1 + L_2) FT \times (W) FT \times (H) FT \times 1000}{50}$$

Example: Refer to Figure 1. Two (2) connecting rooms with an open area between, with the following dimensions.

$$L_1 = 15 \frac{1}{2}$$

$$L_2 = 12'$$

$$W = 12'$$

$$H = 8'$$

$$\frac{(15 \frac{1}{2} + 12) \times (12) \times (8) \times 1000}{50} = 52800 \text{ btu./hr}$$

hr

50

If there was a door between the two rooms the calculation would be based only on the room with the heater.

$$\frac{(15 \frac{1}{2}) \times (12) \times (8) \times 1000}{50} = 27760 \text{ btu./hr}$$

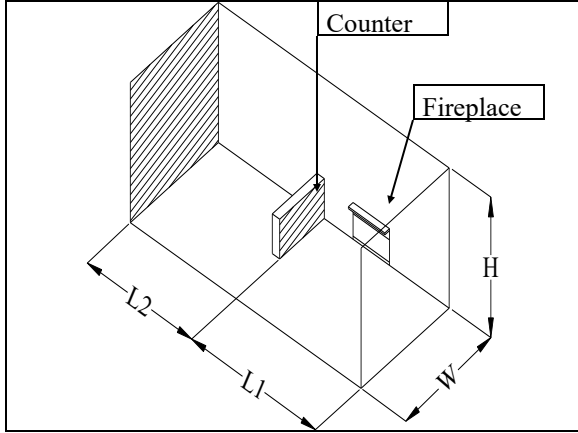

Figure 1. Example of large room with 1/2 wall divider.

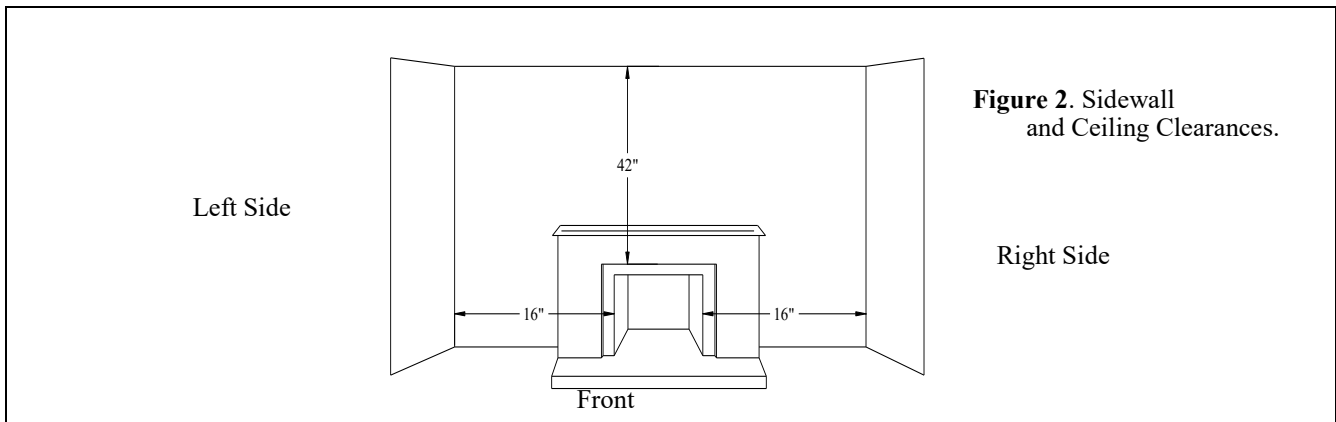

Figure 2. Sidewall and Ceiling Clearances.

WARNING

The dimensions shown in Figure 2 and defined in the fireplace manufacturer's instructions are minimum clearances to maintain in installing this heater. Left and right clearances are determined when facing the front of the heater.

When heater is installed into a unvented firebox, minimum clearances as specified by the unvented firebox manufacturer must be met.

Follow these instructions carefully to ensure safe installation. Failure to follow instructions exactly can create a fire hazard.

Sidewall and ceiling clearances

The sides of the fireplace opening must be at least 16" from any combustible wall. The ceiling must be at least 42" from the top of the fireplace opening.

CLEARANCE/ HEIGHT REQUIREMENTS

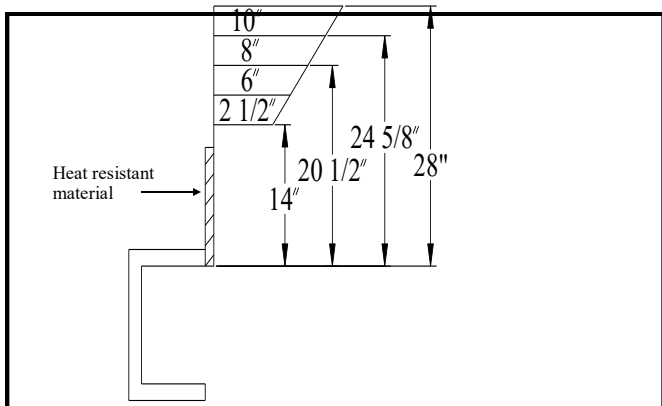

Figure 3.
Minimum Mantel Clearance with No Hood.

Example: The bottom of a mantel may project from the wall a minimum of 14" above the opening. The bottom side of the mantel may project a maximum of 6" at a minimum of 20-1/2" above the opening.

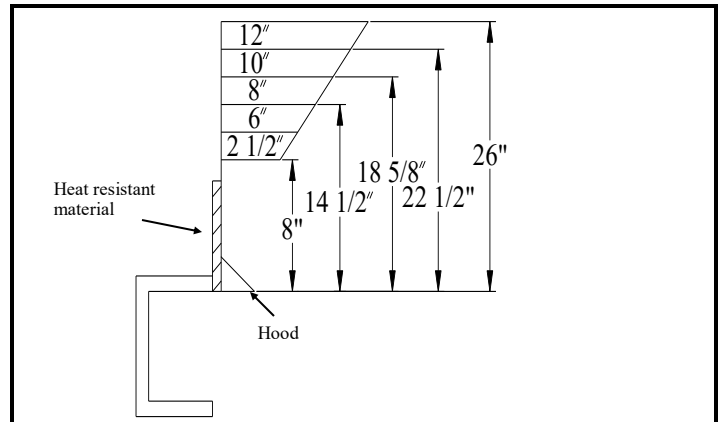

Figure 4.
Minimum Mantel Clearance with Hood.

Example: A mantel may project from the wall a maximum of 2-1/2" at a minimum of 8" above the opening and a maximum of 6" at a minimum of 14-1/2" above the opening.

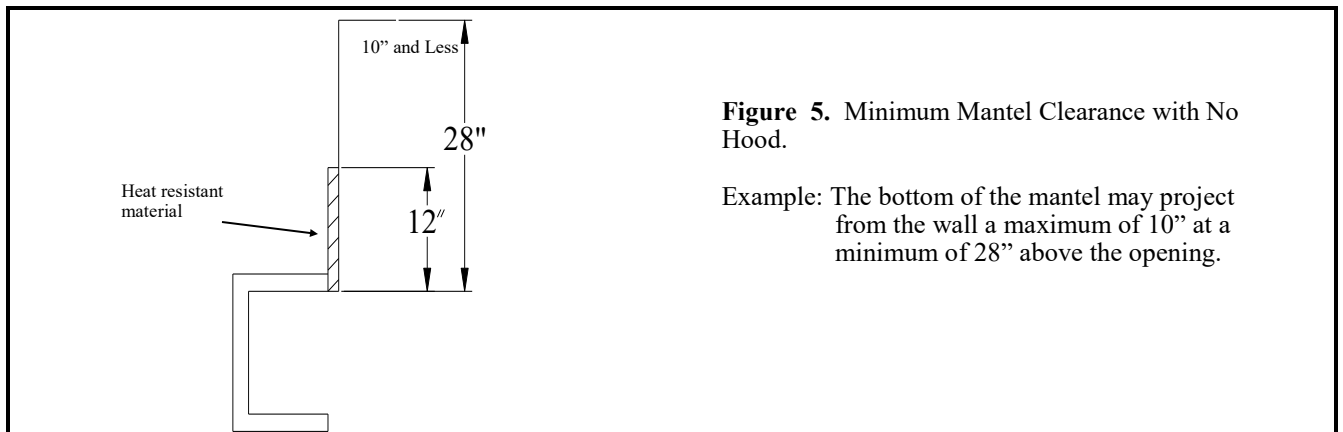

Figure 5. Minimum Mantel Clearance with No Hood.

Example: The bottom of the mantel may project from the wall a maximum of 10" at a minimum of 28" above the opening.

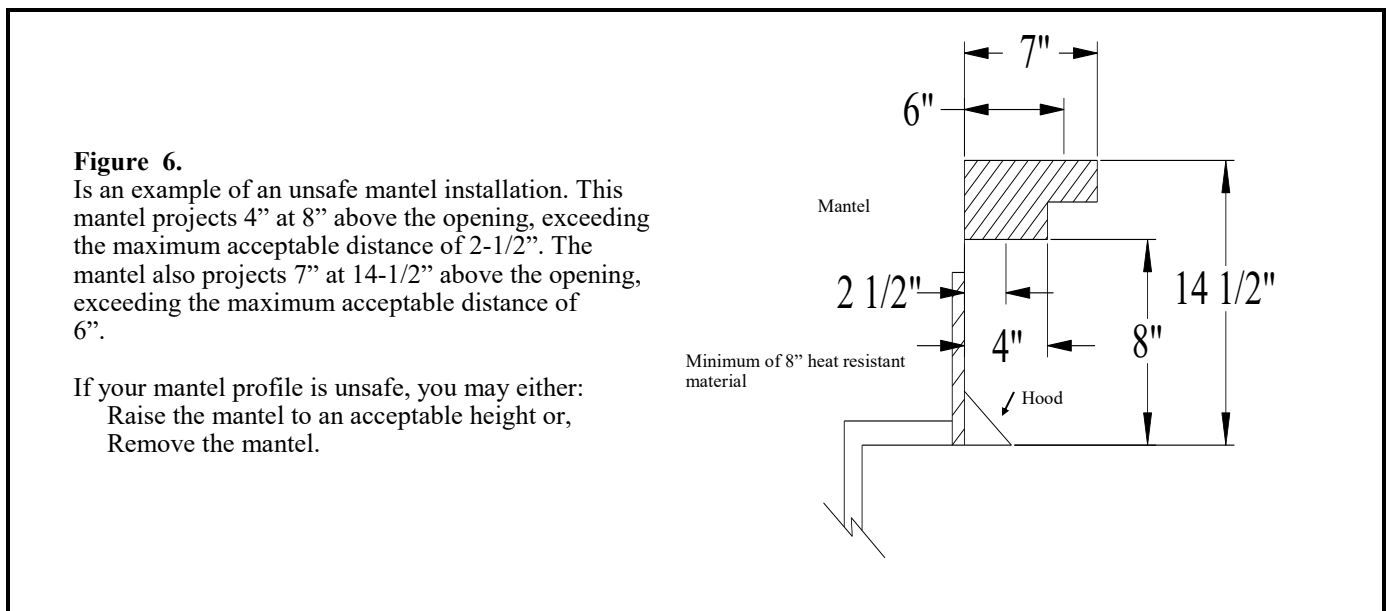
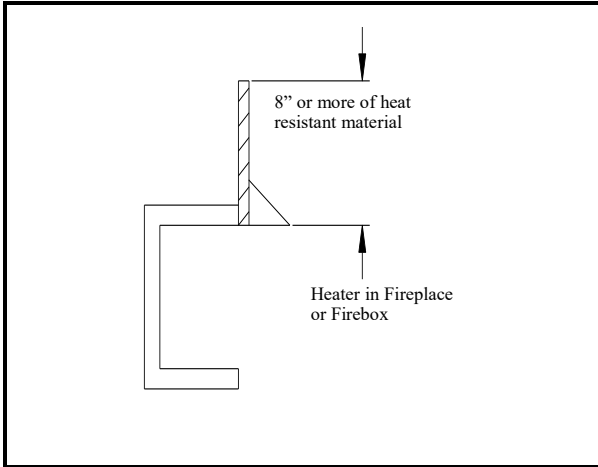

Figure 6.
Is an example of an unsafe mantel installation. This mantel projects 4" at 8" above the opening, exceeding the maximum acceptable distance of 2-1/2". The mantel also projects 7" at 14-1/2" above the opening, exceeding the maximum acceptable distance of 6".

If your mantel profile is unsafe, you may either:
Raise the mantel to an acceptable height or,
Remove the mantel.

CLEARANCE/ HEIGHT REQUIREMENTS cont



Heat resistant material (minimum requirements) with wooden mantel or other combustible projection:

To install the heater with a wooden mantel, shelf or other combustible projection above, first measure the heat resistant material shown in Figure 7.

Figure 7.
Measuring heat resistant material for mantel.

Heat Resistant Material measurement	Requirements for safe installation with wooden mantel, shelf or other combustible projection.	
12" or more	Hood not required. Observe profiles (side elevations) shown in Figure 3.	Hood not required. Observe profiles (side elevations) shown in Figure 5.
8" to less than 12"	Install hood and observe profiles shown in Figure 4. Or extend heat resistant material to at least 12" observe profiles shown in Figure 3.	Install hood and observe profiles shown in Figure 4. Or extend heat resistant material to at least 12" observe profiles shown in Figure 5.
Less than 8"	Extend heat resistant material to at least 8" . Install hood and observe profiles shown in Figure 4. Or extend heat resistant material to at least 12" and observe profiles shown in Figure 3.	Extend heat resistant material to at least 8" . Install hood and observe profiles shown in Figure 4. Or extend heat resistant material to at least 12" and observe profiles shown in Figure 3.

FLOOR CLEARANCE

This gas log heater must be installed at least 5" above any combustible flooring material, such as carpeting or tile, which is closer than 14" to the base of the fireplace. This minimum distance must be maintained from the top surface of carpeting, tile, etc. Refer to Figure 8.

Figure 8.
Minimum clearance above combustible flooring.

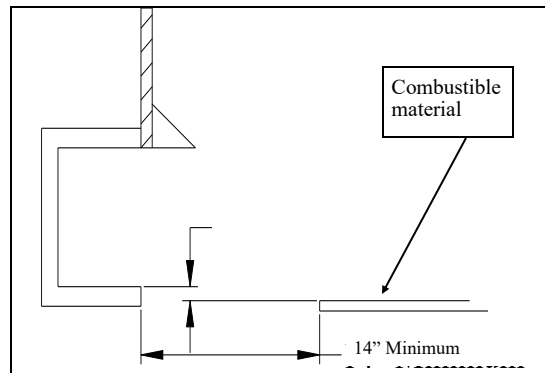
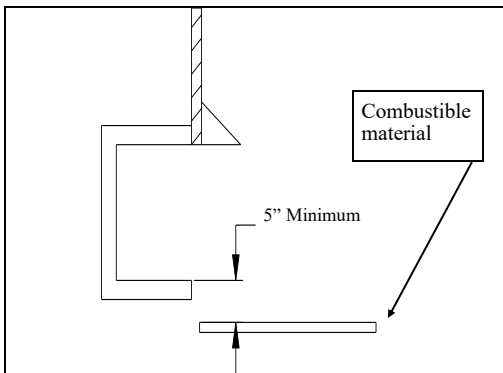

Figure 9.
Minimum clearance above combustible flooring with non-combustible material installed at base of fireplace.

This gas log heater may be installed nearer to the floor if a minimum of 14" of noncombustible material such as slate or marble is installed between the base of the fireplace and the combustible flooring. Refer to Figure 9.

FIREPLACE PREPARATION

Before fully installing the unit:

- Turn OFF the gas supply to the fireplace or firebox.
- Seal any fresh air vents and/or ash clean-out doors located on the floor or wall of the fireplace. If left unsealed, drafting may cause pilot outage or sooting. Use a heat resistant sealant. Do not seal the chimney flue damper.

WARNING

Before installing in a solid fuel burning fireplace, the chimney flue and firebox must be cleaned of soot, creosote, ashes and loose paint by a qualified chimney cleaner.

OPTIONAL VENTED APPLICATIONS

Manual and Remote controlled gas logs may be installed as a vented decorative log set in compliance with ANSI Z21.60 and National Fuel Gas Code, Section 6.6. Since the gas logs are operated with the damper open, non-combustible material and minimum mantel requirements do not apply.

WARNING

This appliance is for installation only in a solid fuel burning fireplace (masonry of manufactured fireplace) with a working flue and constructed of non-combustible material.

Before installing the appliance:

- Turn OFF the gas supply to the fireplace or firebox.
- Have the fireplace floor and chimney professionally cleaned to remove ashes, soot, creosote or other obstructions. Have this cleaning performed annually after installation.
- Seal any fresh air vents and/or ash clean-out doors located on the floor or wall of the fireplace. If left unsealed, drafting may cause pilot outage or sooting. Use a heat resistant sealant. Do not seal the chimney flue damper.

Install and operate the appliance as directed in this manual.

Damper Stop Installation:

Damper Stop sold separately.

A damper stop must be provided with the unit. Contact your dealer to obtain one. The damper stop must be installed as shown in Figure 10 to prevent full closure of the fireplace damper blade and provide a minimum 29 sq. in. flue opening.

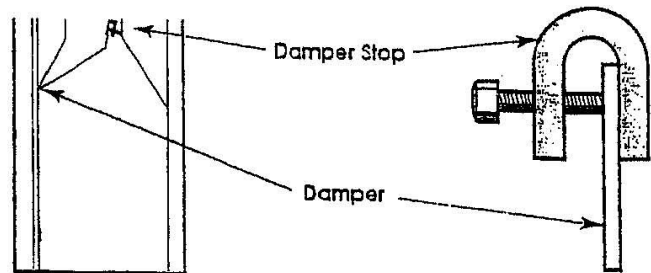

Figure 10.

Damper stop installation.
Damper Stop sold separately.

MAINTENANCE OF THE SYSTEM

Under normal use this appliance will require only limited cleaning. Constant airflow through this appliance will cause dust to collect on the burners, base and logs. An excessive build up of dust can cause the pilot and burners to operate incorrectly and produce high levels of carbon monoxide, a poisonous gas.

To clean the burner and base, turn the control to OFF and allow the system to cool down. Remove top logs and front log very carefully. Vacuum or brush away all dust and lint from the system. Do not use any cleaning fluids to clean the logs or any other part of the appliance.

Replace the logs in their proper positions and relight the pilot. At least once a year, the log set and all gas piping should be inspected by a qualified service person.

WARNING

When used without fresh air, appliance may give off carbon monoxide, an odorless, poisonous gas.

OPEN WINDOW AN INCH OR TWO FOR FRESH AIR WHEN USING APPLIANCE.

This appliance has a Pilot Light Safety System that turns the appliance off if enough fresh air is not available.

DO NOT TAMPER WITH PILOT LIGHT SAFETY SYSTEM.

If appliance shuts off, do not re-light until you provide fresh air. If the appliance continues to shut off, have it serviced by a qualified technician. Keep burner and control compartment clean.

CARBON MONOXIDE POISONING MAY LEAD TO DEATH.

Early signs of carbon monoxide poisoning resemble the flu, with headache, dizziness and/or nausea.. If you experience any of these symptoms, the appliance may not be working properly. Get fresh air at once! Have appliance serviced by a qualified service technician.

Some individuals, pregnant women, persons with heart or lung disorders, anemia, those under the influence of alcohol or at locations of high altitudes are more likely to be affected by carbon monoxide than others.

Due to high temperatures, this appliance must be located out of traffic and away from furniture and draperies.

Adults and specially young children should be alerted to the hazard of high surface temperatures and should be kept away to avoid burns or clothing ignition.

Young children should be carefully supervised when in the same room as the appliance.

Any safety screen or guard removed for servicing the appliance must be replaced prior to operating the appliance.

Do not place clothing or other flammable material on or near the appliance.

Installation and repair should only be done by a qualified service technician.

The appliance should be inspected before use and at least once a year by a qualified service technician.

More frequent cleaning may be required due to excessive lint from carpeting, bedding or other materials. It is imperative that control compartments, burners and circulating air passageways of this appliance be kept clean.

WARNING: DO NOT allow fans to blow directly into fireplace. Avoid any drafts that alter burner flame patterns.

WARNING: DO NOT use a blower insert, heat exchanger insert or other accessories not approved for use with this heater.

EWCL18 To be used with the following burners: EWCL18NV and PV

Step 1: Place back log H-1153. Place Middle log H-1152 then place the front left H-1150 and the front right H-1151



Step :2 Place log H-1121 and H-1154

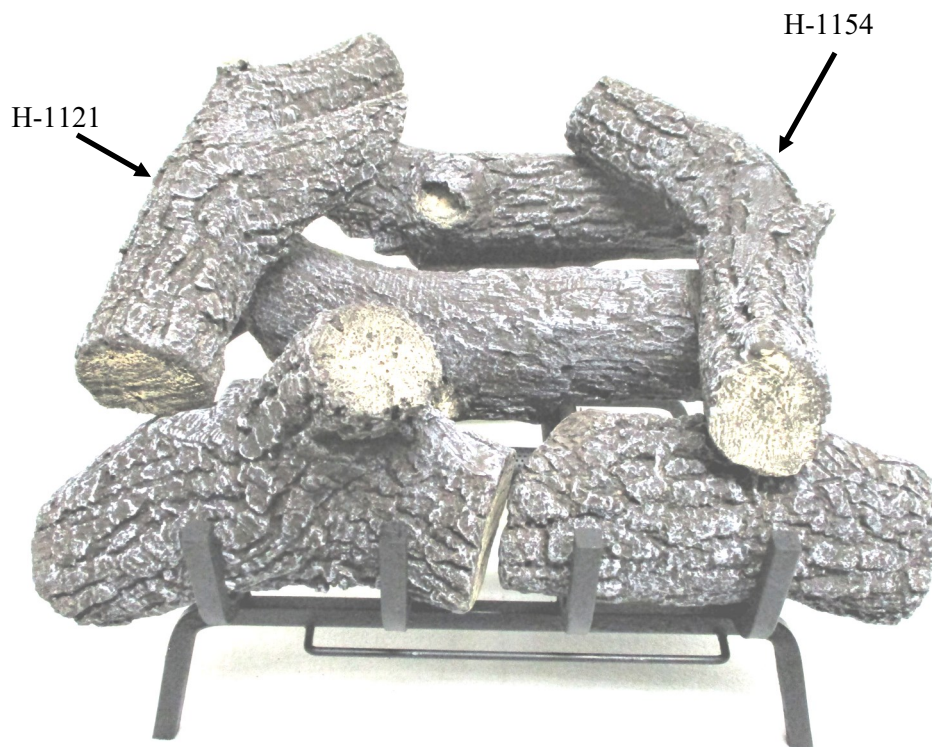

EWCL18

Step 3: Place log H-1123

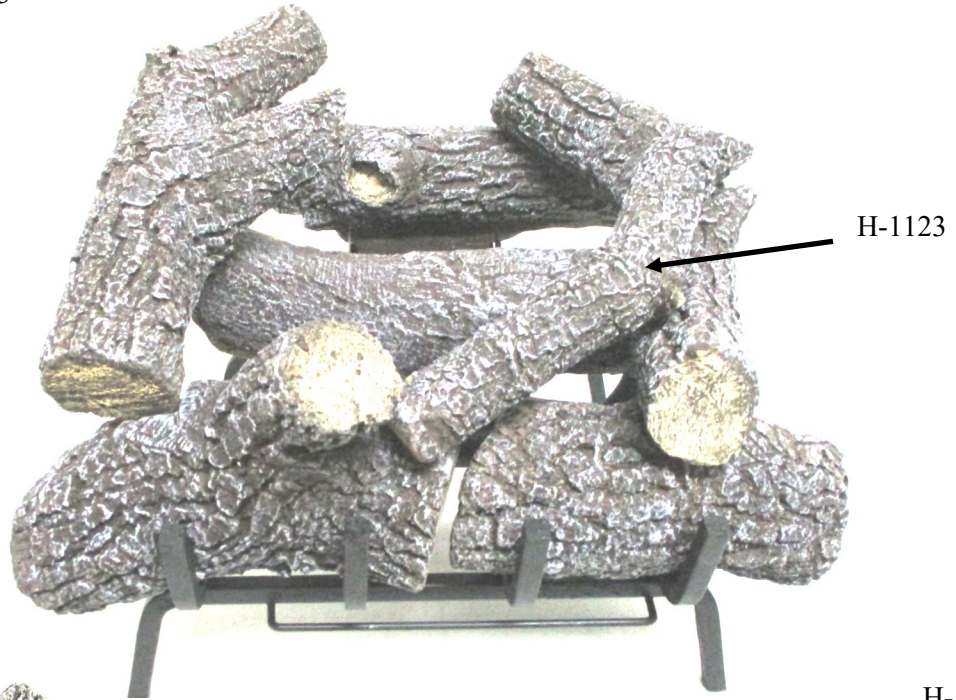

H-1150



H-1151



H-1153



H-1121



H-1152



H-1154



H-1123



EWCL24 To be used with the following burners: EWCL2430NV and PV

Step 1: Place back log H-1122. Place Middle log H-1119 then place the front left H-1117 and the front right H-1118

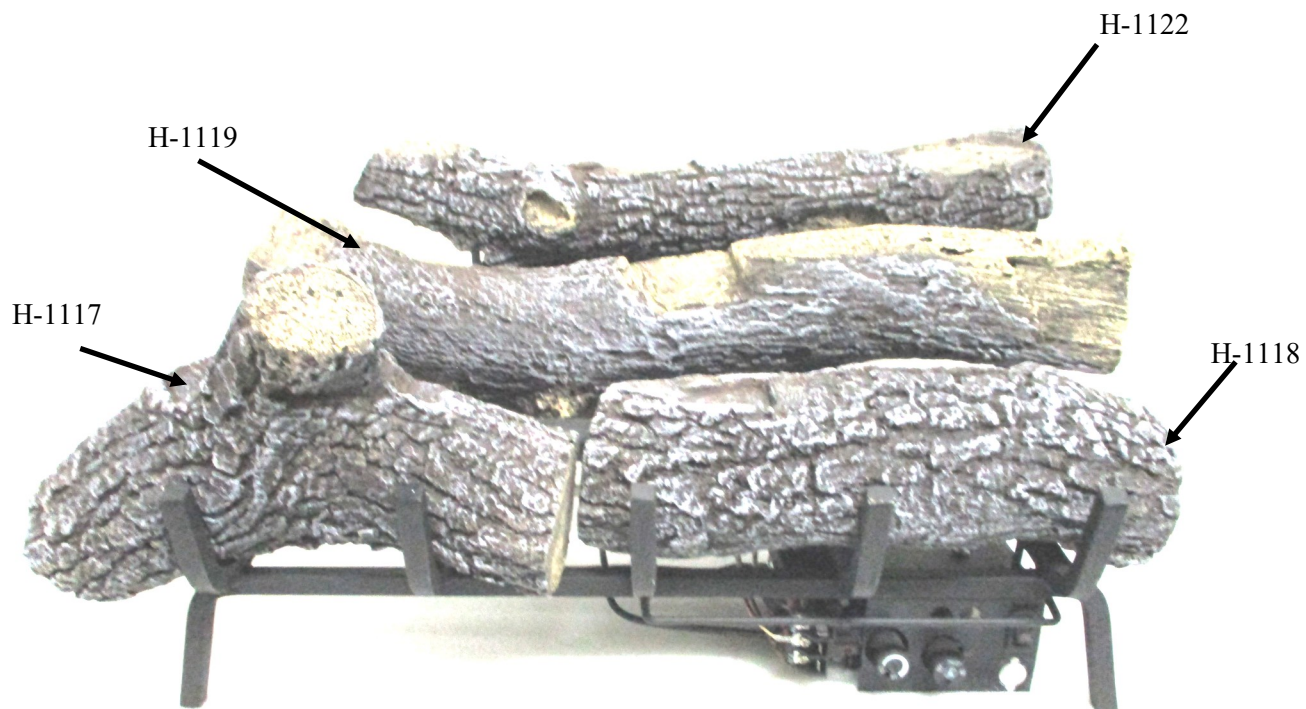

Step 2: Place log H-1121 and H-1130



EWCL24

Step 3: Place log H-1120 and H-1123

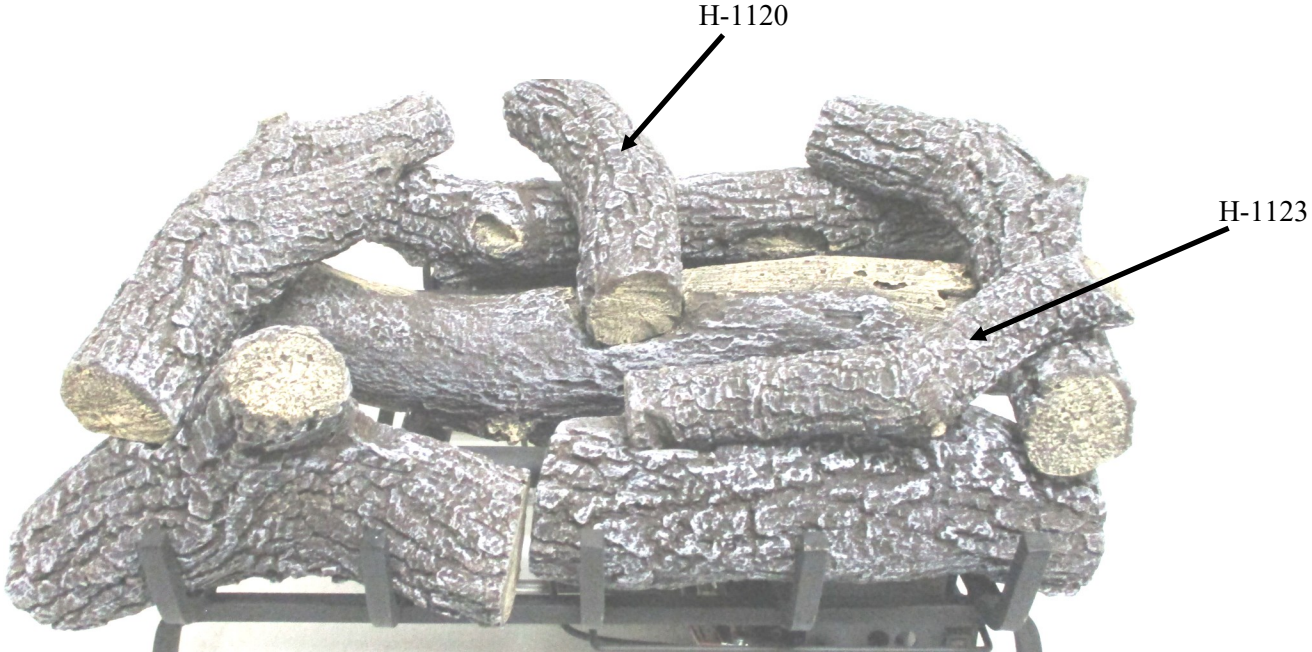

H-1117



H-1118



H-1122



H-1119



H-1121



H-1130



H-1120



H-1123



EWCL30 To be used with the following burners: EWCL2430NV and PV

Step 1: Place back log H-1128. Place Middle log H-1127 then place the front left H-1125 and the front right H-1126

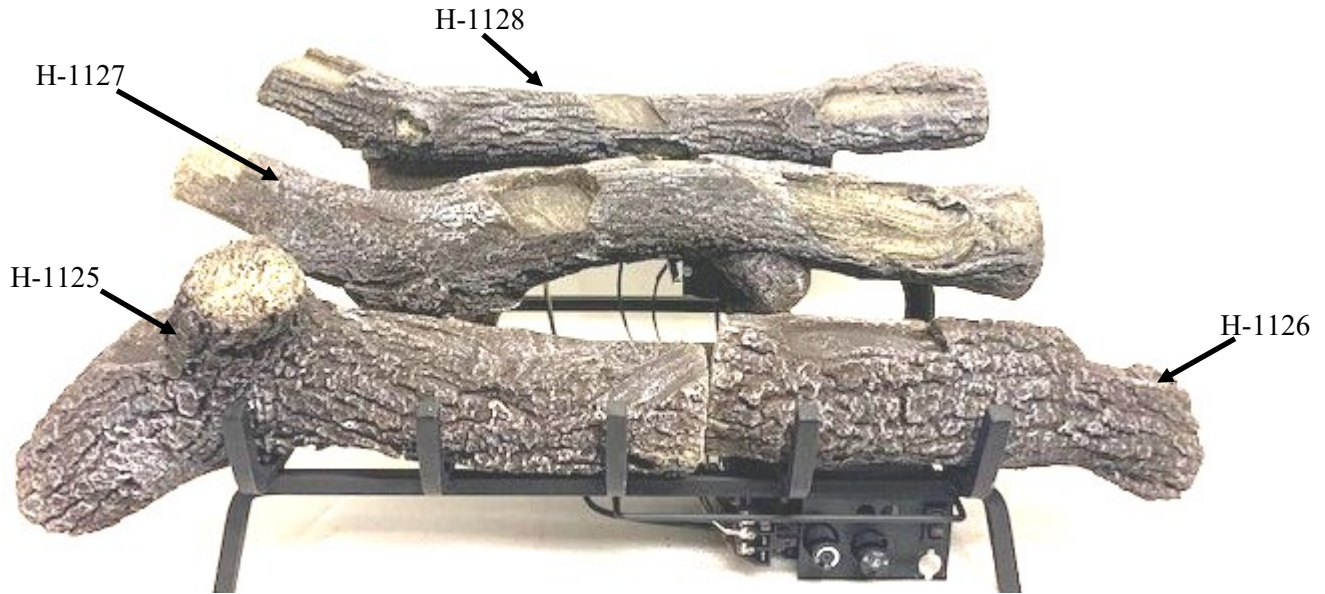

Step 2: Place log H-1121 and H-1129



EWCL30

Step 3: Place log H- 1167, H-1168 and H-1123

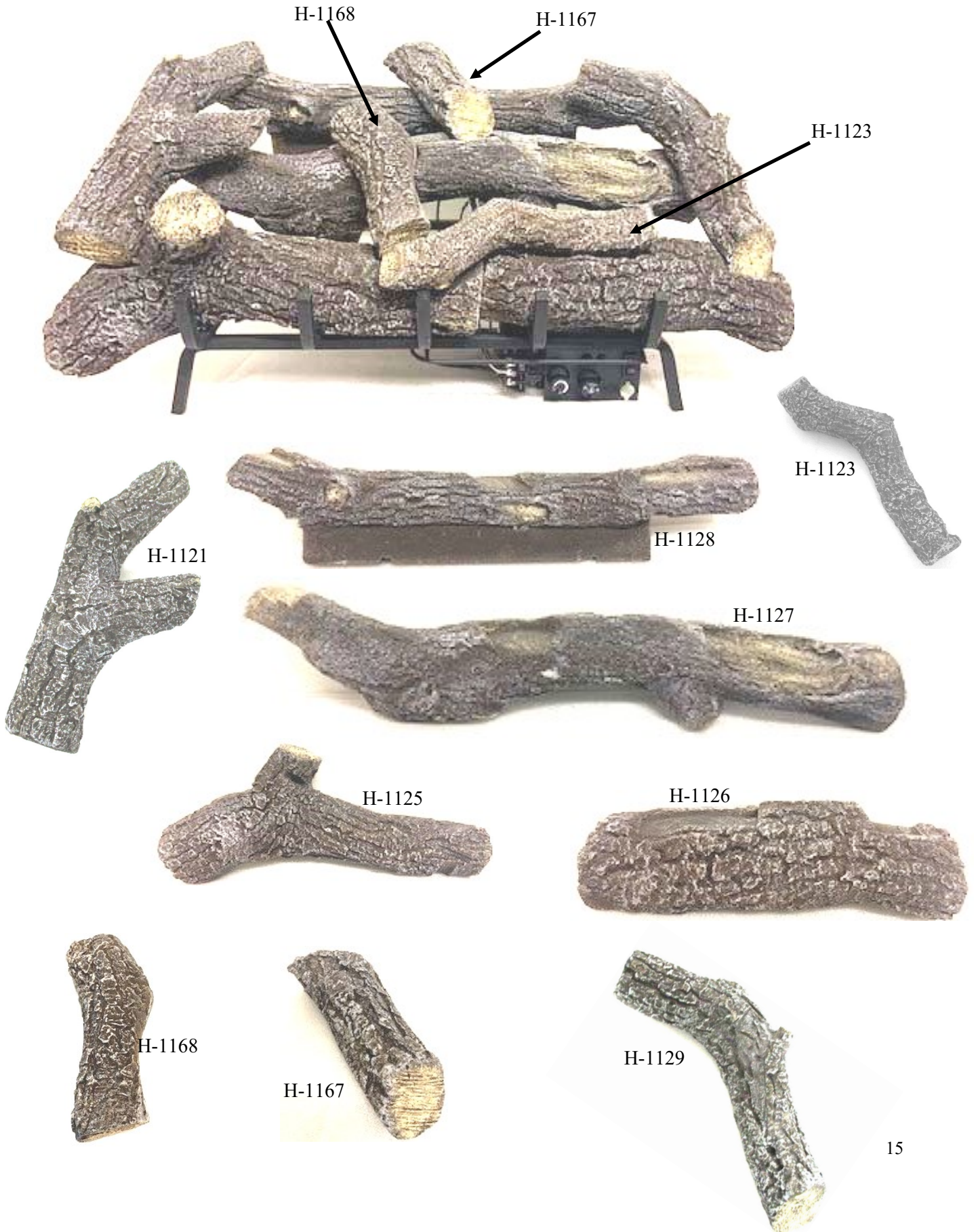

TROUBLESHOOTING

WARNING Turn appliance OFF and allow to cool before servicing. Only a qualified service person should service and/or repair the heater.

Note: All troubleshooting items are listed in order of operation.

OBSERVED PROBLEM	POSSIBLE CAUSE	REMEDY
(Millivolt unit only) When igniter is pushed there is no spark at the ODS/pilot.	<ol style="list-style-type: none"> 1. Igniter electrode positioned wrong. 2. Igniter electrode is broken. 3. Igniter electrode not connected to igniter cable. 4. Igniter cable pinched or wet. 5. Broken igniter cable. 6. Bad piezo igniter. 	<ol style="list-style-type: none"> 1. Replace igniter. 2. Replace igniter. 3. Reconnect igniter cable. 4. Free igniter cable if pinched by any metal or tubing. 5. Replace igniter cable. 6. Replace piezo igniter.
Appliance produces unwanted odors.	<ol style="list-style-type: none"> 1. Appliance burning vapors from paint, hair spray, glues, etc. 2. Gas leak. 	<ol style="list-style-type: none"> 1. Ventilate room. Stop using odor causing products while heater is in use. 2. Call gas company.
Appliance shuts off during use	<ol style="list-style-type: none"> 1. Not enough fresh air is available for ODS/pilot to operate. 2. Low gas line pressure. 3. ODS/pilot is partially clogged. 4. Defective thermocouple. (Millivolt only) 	<ol style="list-style-type: none"> 1. Open window and/or door for ventilation. 2. Contact local gas company. 3. Clean ODS/pilot. 4. Have thermocouple checked by qualified person.
Gas odor even when control knob is in the OFF position.	<ol style="list-style-type: none"> 1. Gas leak. 2. Control valve defective 	<ol style="list-style-type: none"> 1. Call gas company. 2. Replace control valve.
(Millivolt unit only) When igniter is pushed there is a spark at the ODS/pilot, but no ignition.	<ol style="list-style-type: none"> 1. Gas supply turned off or shutoff valve closed. 2. Control knob not in pilot position. 3. Control knob not pressed in while in PILOT position. 4. Air in gas lines when installed. 5. ODS/pilot is clogged. 	<ol style="list-style-type: none"> 1. Turn on gas supply or open shutoff valve. 2. Turn control knob to PILOT position. 3. Press in control knob while turning to PILOT position. 4. Continue holding down control knob. Repeat igniting operation until air is removed. 5. Replace ODS/pilot assembly or get it serviced.

TROUBLESHOOTING cont.

OBSERVED PROBLEM	POSSIBLE CAUSE	REMEDY
(Millivolt unit only) ODS/pilot lights, but flame goes out when control knob is released.	<ol style="list-style-type: none"> 1. Control knob not fully pushed in. 2. Control knob not pressed in long enough. 3. Manual shut off valve not fully open. 4. Thermocouple connection loose at the control valve. 5. Pilot flame not touching thermocouple, which allow the thermocouple to cool, causing pilot flame to go out. This problem could be caused by either low gas pressure or a dirty or partially clogged ODS pilot. 6. Thermocouple damaged. 7. Control valve damaged. 	<ol style="list-style-type: none"> 1. Press in control knob fully. 2. After ODS/pilot lights, keep control knob pressed in for 30 seconds. 3. Fully open manual shutoff valve. 4. Hand tighten until snug, then tighten 1/4 turn more. 5. Contact your local gas company or clean the pilot. 6. Replace thermocouple. 7. Replace control valve.
Burner will not light after ODS/pilot is lit.	<ol style="list-style-type: none"> 1. Burner ports are clogged. 2. Inlet gas pressure too low. 3. Control knob not in the "on" position. 4. Bad thermopile 5. Pilot clogged. 	<ol style="list-style-type: none"> 1. Clean burner ports. 2. Contact qualified service person. 3. Turn control knob to "on" position. 4. Replace thermopile. 5. Clean pilot.
Burner backfires during combustion.	<ol style="list-style-type: none"> 1. Manifold pressure is too low. 2. Burner clogged. 	<ol style="list-style-type: none"> 1. Contact local gas company. 2. Clean burner tube.
Odor during initial operation.	<ol style="list-style-type: none"> 1. New logs . 	<ol style="list-style-type: none"> 1. Allow to burn several hours.
Heater produces a whistling noise when burner is lit.	<ol style="list-style-type: none"> 1. Turn control knob (Millivolt) to high position or remote to high position (IPI) when burner is cold. 2. Air in the gas line. 3. Dirty or partially clogged burner orifice. 4. Bad burner orifice. 	<ol style="list-style-type: none"> 1. Turn control knob (Millivolt) to low position or remote to low position (IPI) and let warm up for a minute. 2. Operate burner until air is removed from the gas line. Have gas line checked by local gas company. 3. Clean burner or replace burner orifice. 4. Replace burner orifice.
No gas to pilot.	<ol style="list-style-type: none"> 1. LP regulator shut down due to inlet pressure being too high. 2. Gas is cut off. 3. Air in pilot gas line. 	<ol style="list-style-type: none"> 1. Verify LP tank regulator is installed and set at 10" to 11" W.C. 2. Verify gas is on. 3. Refer to lighting instructions.

FOR YOUR SAFETY READ BEFORE LIGHTING

WARNING: If you do not follow these instructions exactly a fire or explosion may result causing property damage, personal injury, or loss of life.

- A. This appliance is equipped with a push button piezo ignition device, which can be used to light the pilot. If the piezo fails to ignite the pilot, then follow the instructions for lighting pilot with match.
- B. BEFORE LIGHTING smell all around the appliance area for gas. Be sure to smell next to the floor because some gas is heavier than air and will settle on the floor.



WHAT TO DO IF YOU SMELL GAS

- ◆ Do not try to light any appliance.
 - ◆ Do not touch any electrical switch; do not use any phone in your building.
 - ◆ Immediately call your gas supplier from a neighbor's phone. Follow the gas supplier's instructions.
 - ◆ If you cannot reach your gas supplier, call the fire department.
- C. Use only your hand to push in or turn the gas control knob. Never use tools. If the knob will not push in or turn by hand, do not try to repair it. Call a qualified service technician. Force or attempted repair may result in fire or explosion.
- D. Do not use this room heater if any part has been under water. Immediately call a qualified service technician to inspect the room heater and replace any part of the control system and any gas control that has been under water.

LIGHTING INSTRUCTIONS

1. STOP! Read the safety information

previously listed above.

2. Turn main gas control knob (FIG. 11) clockwise  to the "OFF" position.
3. Wait five (5) minutes to clear out any gas. Then smell for gas, including near the floor. If you smell gas, STOP! Follow "B" in the safety information above on this label. If you don't smell gas, go to the next step.
4. Locate pilot - mounted on the inside of the right hand bracket that holds the burner in place, just behind the front part of the burner. (FIG. 12)
5. Depress main control knob (FIG. 11) and turn counterclockwise  to the "PILOT" position. With main control knob (FIG. 11) at "PILOT", depress until it stops and press on the igniter push-button several times. (FIG. 11) This will cause a spark at the pilot burner, which will ignite the pilot flame. Continue to hold the main control knob (FIG. 8) in for about (1) minute after the pilot is lit. Release knob and it will pop back out. Pilot should remain lit. If it goes out, repeat steps 1 through 5.
 - ◆ If the knob does not pop out when released, stop and immediately call your service technician or gas supplier.
 - ◆ LIGHTING PILOT WITH MATCH: Turn main control knob (FIG. 11) to the "PILOT" position. Place a lit match at the pilot burner, then push the main control knob in. Continue to hold the control knob in for about one (1) minute after the pilot is lit. Release knob and it will pop back out. Pilot should remain lit. If it goes out, repeat the above step.
 - ◆ If the pilot will not stay lit after several tries, turn the gas control knob (FIG.8) to "OFF" and call your service technician or gas supplier.
6. Depress main control knob (FIG. 11) and turn counterclockwise  to the "ON" position. Adjust heat output to the desired level by turning the HI/LOW control knob.

TURN OFF GAS TO APPLIANCE

Turn main gas control knob (FIG. 11) clockwise  to the "OFF" position. Do not force.

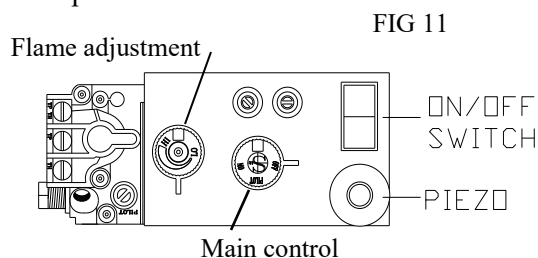
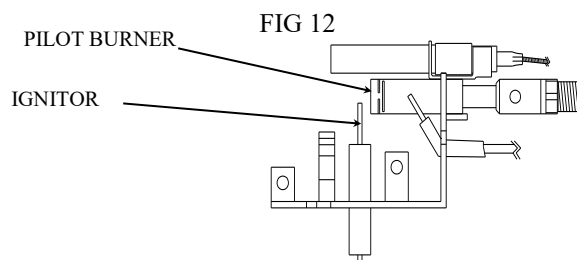

UNIT PLACEMENT

Place the entire unit system in the center of the fireplace to allow proper air flow on all sides of the unit.

GAS PIPING AND GAS PRESSURE REQUIREMENTS

Check the type of gas that is supplied to your fireplace. Use only the gas type indicated on the heater's rating plate. If the gas listed on the plate is not your type of gas supply, **DO NOT INSTALL THE SYSTEM.** Contact your dealer.

All gas piping must be installed to comply with local and National Fuel Gas codes. Do not use flexible hose unless it is allowed by local codes. Compounds used on threaded joints of gas piping must be resistant to the action of LP gas.

The gas supply line to the fireplace should not be less than 1/2" inside dimension.

GAS PRESSURE: Minimum inlet gas supply pressure must be 7.0" WC for natural gas or 11" WC for LP gas for the purpose of input adjustment. Maximum inlet gas supply pressure must not exceed 10.5" WC for natural gas, or 13" WC for LP gas. The gas line supplying the appliance must be of sufficient size to furnish the appropriate supply pressure to the appliance when being operated on the high setting. Manifold pressure for natural gas is 4" WC and 10" WC for LP gas.

Include a manual shutoff valve and union in the line so the appliance may be disconnected for servicing. Provide a 1/8" NPT plugged tapping for pressure gauge connection between shutoff valve and the appliance. Test for leaks using a soap and water solution after completing the connection. **DO NOT USE AN OPEN FLAME!**

WARNING

The appliance and its appliance main gas valve must be disconnected from the gas supply piping system during any pressure testing of that system at test pressures in excess of 1/2 psig (3.5kPa). The appliance must be isolated from the gas supply piping system by closing its equipment shut-off valve during any pressure testing of the gas supply piping system at test pressures equal to or less than 1/2 psig (3.5kPa).

FLAME APPEARANCE

Periodically check the pilot and burner flame:

The pilot flame must always be present when the heater is in operation. It should just touch the top of the thermocouple tip.

Flames from the pilot should be visually checked as soon as the heater is installed. Periodically check the flames visually during operation. See Figure 13.

If the pilot flame does not touch the thermocouple, then the main burner cannot function reliably. Refer to Figure 14 for incorrect shape of the pilot flame.

Figure 13.

Correct appearance of pilot flame.

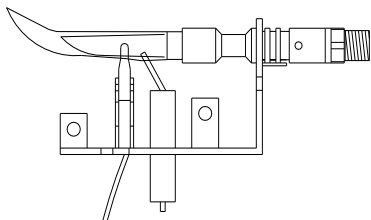
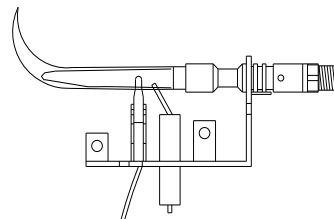
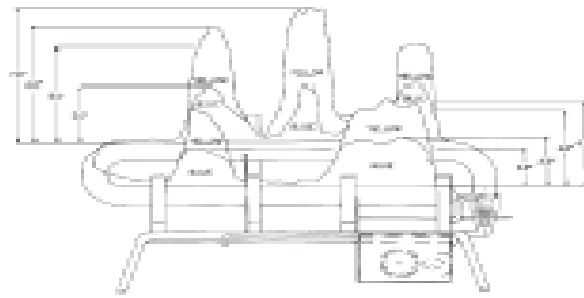

Figure 14.

Incorrect appearance of pilot flame.





18" Log Set

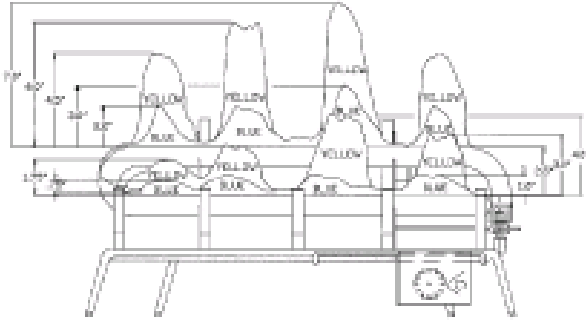

24" Log Set

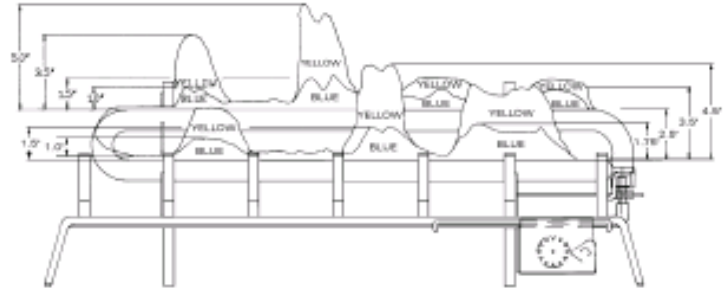

30" Log Set

WARNING

INSTALLER: Please be sure the homeowner understands these key points.

Periodically clean loose particles, dust and lint from pilot and front and rear burner ports. Clean burner air intake holes. Failure to do so may result in sooting and poor combustion.

Logs and volcanic rock must be positioned correctly. Failure to do so may result in sooting and poor combustion.

“All previously applied loose material must be removed prior to reapplication”.

Do not operate ceiling fans while using this heater. Drafts from fans may alter flame pattern, which could result in sooting and poor combustion.

If unit is installed in an existing fireplace, do not operate heater with glass doors closed. This will result in sooting and poor combustion.

PLACEMENT OF LAVA GRANULES

Pour the lava granules on the floor of the fireplace in front of the bottom burner.

NOTE: These granules are for use only to cover the fireplace floor and are not to be used in or on the burner itself.

***Do not place lava rock on or near the burner. Place in front and around sides of the burner, not on it.
CONTACT WITH BURNER CAN CAUSE CARBON MONOXIDE.***

GUIDELINES FOR APPLICATION/MAINTENANCE OF ODS PILOTS

Technical Application:

1. For accurate and consistent ODS intervention (cutoff) performance, the applied ODS must always be connected to a control valve having a preferred dropout rating of 80mA and not less than 65mA.
2. Proper connection of thermocouple to gas safety valve is made by tightening the connection nut by hand and then turning it 1/4 turn using the proper sized wrench. Do not over tighten as damage to safety valve may result.
3. Recommended connection of the pilot tubing to the ODS is made by using two proper sized wrenches: one to tighten and one to hold the device. While tightening the connections do not stress the pilot. Do not use thread sealant, tape or rubber gaskets.
4. Misplacement of the gas logs could effect the temperature of the thermocouple and cause the pilot not to perform as intended.
5. The location of the ODS must allow complete burner ignition in the time allowed by applicable standard at the extremes of the manufacturing tolerances.
6. **CAUTION:** Never use a wire, needle or similar object to clean ODS/Pilot. This can damage the ODS/Pilot unit.

*The ODS pilots comply with current safety standards. Nevertheless, their installations on appliances must be verified in accordance with the specific standard for each appliance. Do not tamper with sealed components or remove marking.

Annual inspection and cleaning by your dealer or qualified technician is recommended to prevent malfunction and/or sooting.

WARNING

If the gas quality is bad, your pilot light may not stay lit, the burners may produce soot and the heater may backfire when lit. If the gas quality or pressure is low, contact you local gas

Periodic Cleaning– Refer to Parts Diagram for location of items discussed below.

Do not use cleaning fluid to clean logs or any part of the heater.

Logs– Brush with soft bristle brush or vacuum with brush attachment.

Vacuum loose particles and dust from the front and rear burner, control and piezo covers and grate weldment.

Inspect and clean rear and front burner air intake holes. Remove lint or particles with vacuum or brush.

WARNING: Failure to keep air intake holes clean will result in sooting and property damage. External case should be dusted and wiped with a clean cloth.

Annual Cleaning/Inspection– Refer to Parts Diagram for location of items discussed below.

Inspect and clean rear burner air intake holes. Remove lint or particles with vacuum or brush.

Failure to keep air intake holes clean will result in sooting and poor combustion.

Inspect and clean all burner ports.

Inspect ODS/pilot for operation and accumulation of lint at air intake holes.

Verify flame pattern and log placement for proper operation.

Verify smooth and responsive ignition of front and rear burner.

HM2 MILLIVOLT PARTS LIST

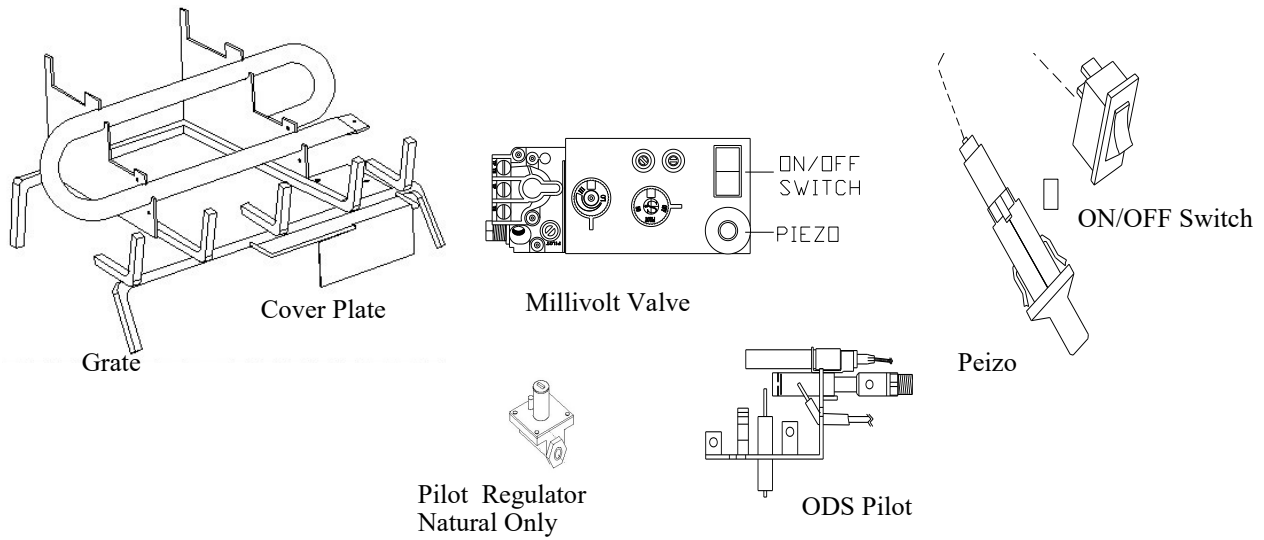

PART	18"	24"	33"
Burner	11-1181B	11-1182B	11-1183B
Grate	11-1265B	11-1270B	11-1275B
Cover Plate	11-1294	11-1294	11-1294
Pilot Brkt Millivolt Not shown	16-1100	16-1100	16-1100
Valve Brkt Millivolt Not shown	16-1121	16-1121	16-1121
Millivolt LP Valve	16-1030	16-1030	16-1030
Millivolt NG Valve	16-1035	16-1035	16-1035
Millivolt ODS LP Pilot	16-1040	16-1040	16-1040
Millivolt ODS NG Pilot	16-1045	16-1045	16-1045
ON/OFF Switch	01-1070	01-1070	01-1070
Pilot Regulator (NG only)	16-1050	16-1050	16-1050
Piezo	11-1166	11-1166	11-1166
Piezo Wire	16-1130	16-1130	16-1130

When ordering, please include complete part number, part name and description. Parts may be ordered directly from:

CUI
 1026 Old Stage Road, Simpsonville, SC 29681
 800-845-5301

Manufactured by:
 Heatmaster
 3625 Benson Rd, Angier, NC

CUI LIMITED WARRANTIES

All individual refractory cement logs manufactured by CUI have a lifetime warranty against breakage due to heat to the original owner in the original installation except for hairline cracks less than 1/16" in width.

All other logs supplied from CUI have a 2-year warranty against breakage due to heat to the original owner in the original installation.

- All metal parts, including burners and grate assemblies are warranted for 5 years.
- All other mechanical parts are warranted for 1 year.
- **All defective parts must be returned to CUI before replacement will be issued.**

LIMITATIONS

1. CUI'S obligations to the purchaser under this warranty is limited to the repair or replacement of defective part.
2. Repairs or replacement will be performed by CUI following delivery of the product by the purchaser to CUI's facility in Simpsonville, South Carolina . The cost of mailing CUI shall be borne by CUI for warranty claims only. In-person delivery may request a labor credit up to the maximum allowed by the manufacture at the time of the request. Labor credit maximums are subject to change at any time. The mailing address is: CUI, 1026 Old Stage Rd., Simpsonville, SC 29681.
3. Along with the product, the purchaser shall include a written explanation of the approximate date the product was purchased, the dealer or person from whom the product was purchased, the date the defect was first noticed, a description of the nature of the defect, and what the purchaser did, if anything, to repair or correct the defect.
4. To the extent allowed by law, any implied warranty of merchantability of fitness applicable to this product is limited to the duration of this warranty. CUI shall not be liable for loss of use of this product, loss of time, inconvenience, commercial loss or consequential damages. The remedy of replacement of a defective part during the warranty period herein specified shall be the purchaser's exclusive remedy.
5. CUI is not responsible for any loss or damages caused by purchaser's failure to follow operating & maintenance instructions provided in owner's manual.

Dear Purchaser:

We are pleased that you have selected our product and take this opportunity to assure you that qualified service is available if required.

DEFECTIVE PARTS OR BROKEN LOGS FOR REPLACEMENTS MUST BE RETURNED TO THE FACTORY PREPAID ALONG WITH PROOF OF PURCHASE.

CUI
1026 Old Stage Road
Simpsonville, SC 29681
800-845-5301
cuiheat.com