

SIGNATURE GAUGE FEATURES

- ALL BLACK WHEN POWERED OFF
- FLASHING CIRCLE GENERAL ALARM
- PROGRAMMABLE TEXT FLASHES WITH ALARMS
- SELECTABLE MULTICOLOUR BACKLIGHT, BRIGHTNESS & CONTRAST
- HIGH RESOLUTION MODE, 0.1 PSI, 0.1 DEGREE ETC.
- PROGRAMMABLE BUTTON OPTION, RECALL+MENU ETC
- MAXIMUM VALUES STORED AND RECALLED FROM MEMORY.
- HIGH, LOW, EXTERNAL & INTERNAL WARNING ALARMS
- HIGH AND LOW BACKLIGHT ALARMS WITH SELECTABLE COLOUR
- EXTERNAL WARNINGS FOR LARGE LED'S OR CONTROL RELAYS
- PROGRAMMABLE LOW BATTERY WARNING
- SELECTABLE AVERAGING FOR PRESSURE.
- SELECTABLE UNITS FOR PRESSURE AND TEMPERATURE
- SOLID STAINLESS PRESSURE SENSORS MEASURE PRESSURE AND VACUUM.
- SPLASH PROOF SENSOR CONNECTORS
- EXTENDED TEMPERATURE RANGE FOR HOT AND COLD CONDITIONS
- THERMOCOUPLE OPTIONS AVAILABLE

INSTALLATION NOTES

Please follow the installation and fitting instructions carefully, and refer to the diagrams on the following pages. Please ensure that the gauge mounted is at least slightly below the driver's eye level to ensure a clear LCD display.

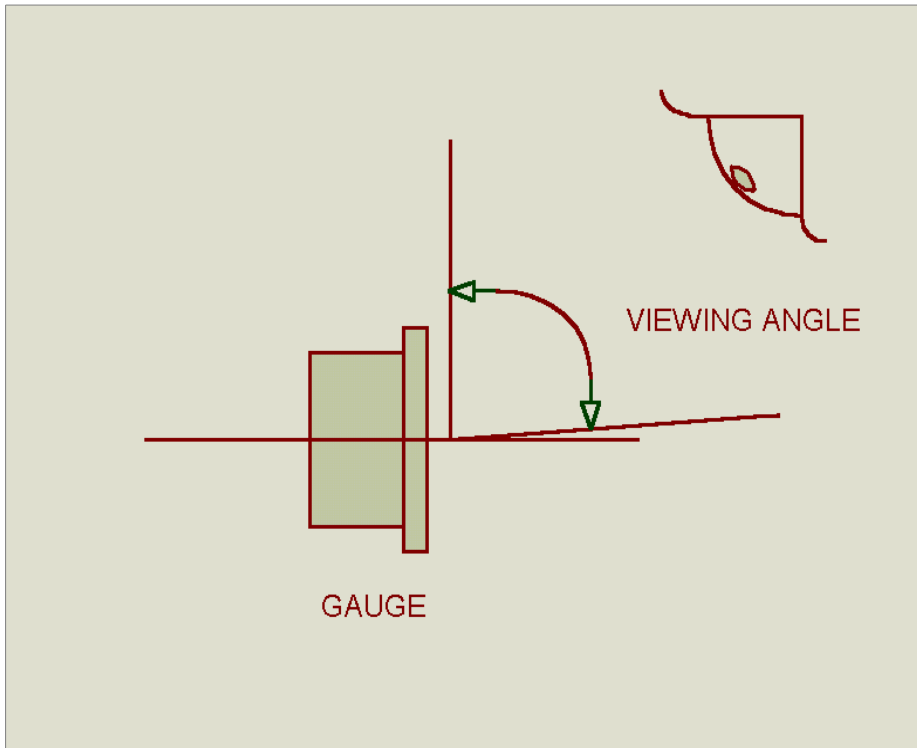

The pressure sensor must be screwed in to a suitable flat surface so that the dowty sealing washer can seal down on to it (see turbo boost pressure installation notes). Please do not over tighten the sensor, the dowty seal does not need to be tight to seal properly.

The temperature sensor has a tapered thread and must be sealed with PTFE tape.

When fitting the pressure sensor plugs, be careful to align the painted marks as shown in the diagram to get correct orientation. The temperature sensor plug has alignment lines moulded into the plug and socket bodies.

If you are fitting the pressure sensor to the output of a pump, and the pressure is pulsing, you may need to increase the 'average time' for the sensor (see menu system).

If the gauge is going to be fitted to a vehicle with high revving engines (>9000) the gauge **MUST** be rubber mounted (see diagram below).

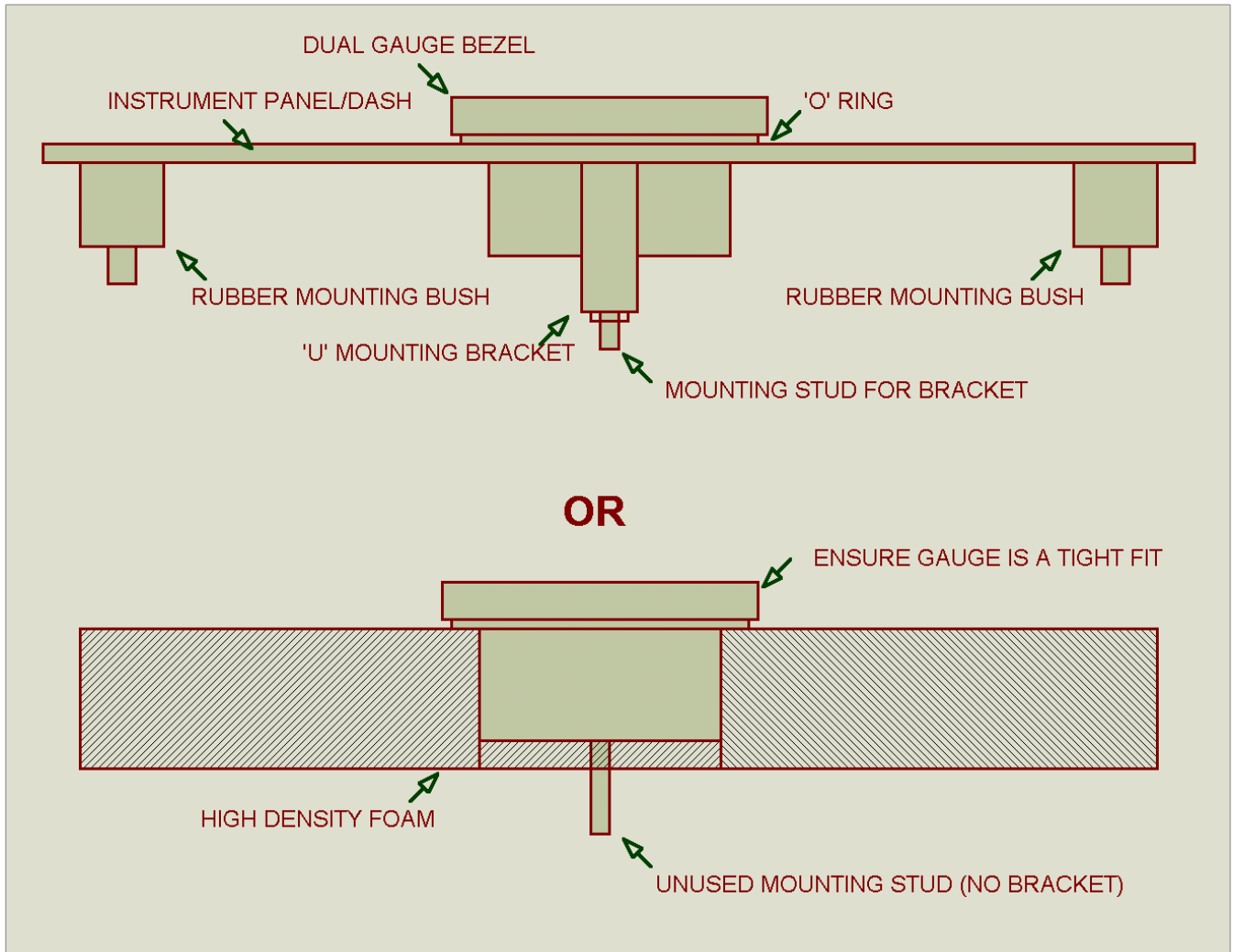

PRESSURE SENSOR MOUNTING

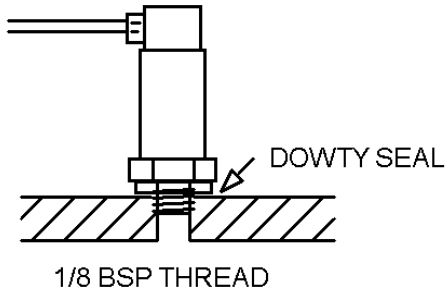

OVERALL SIZE 65 X 22mm

TEMPERATURE SENSOR MOUNTING

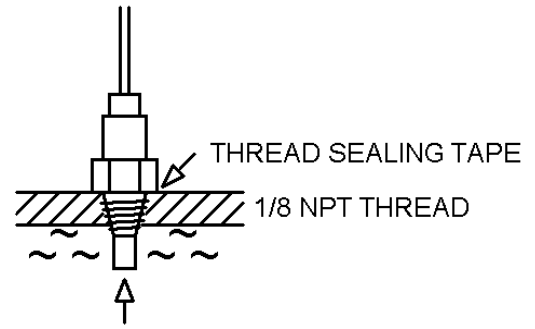

OVERALL SIZE 45 X 15mm

PLUG ORIENTATION

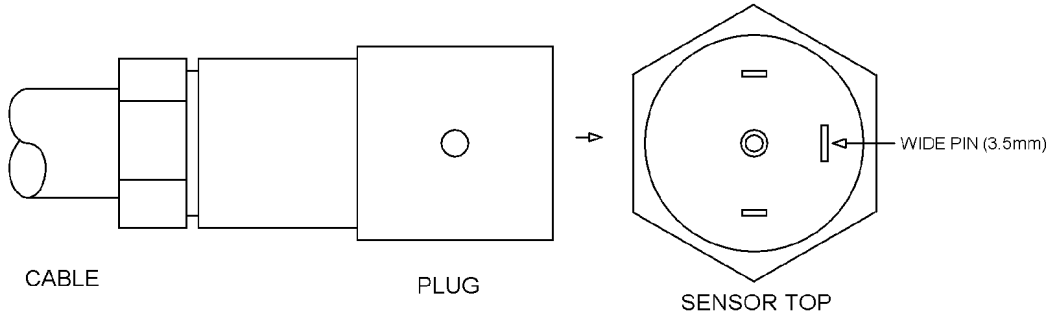

REAR VIEW

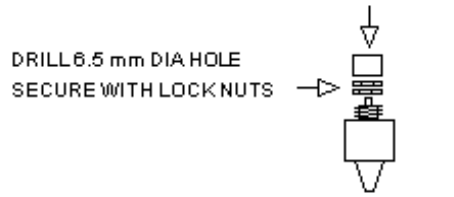
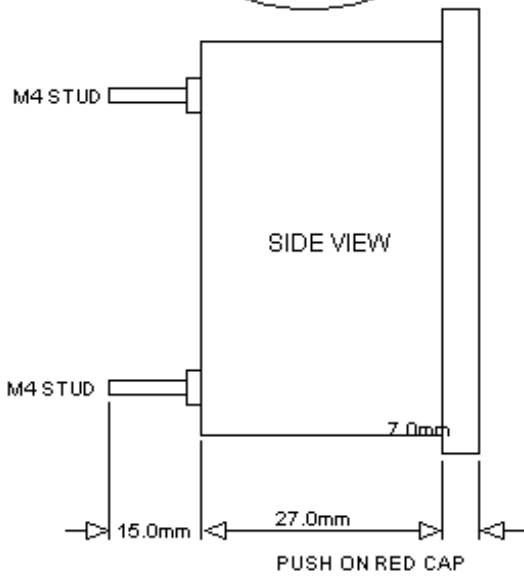
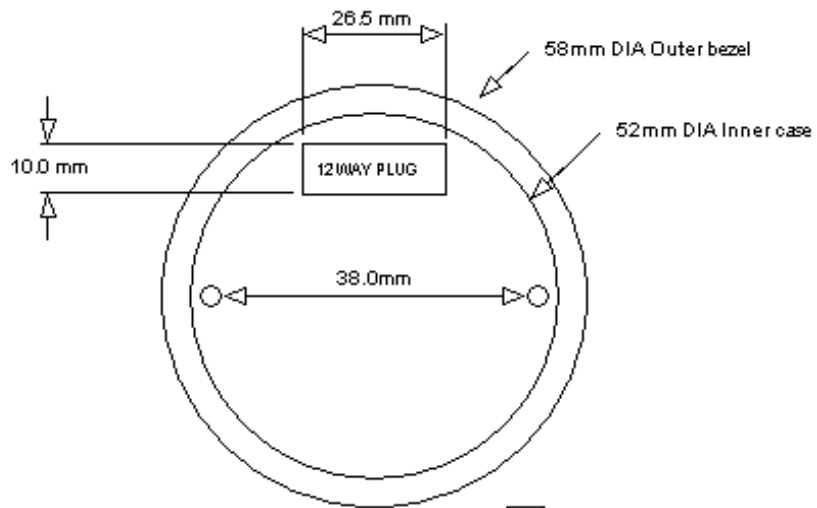

OVERALL SIZE 32 X 13 X 7mm

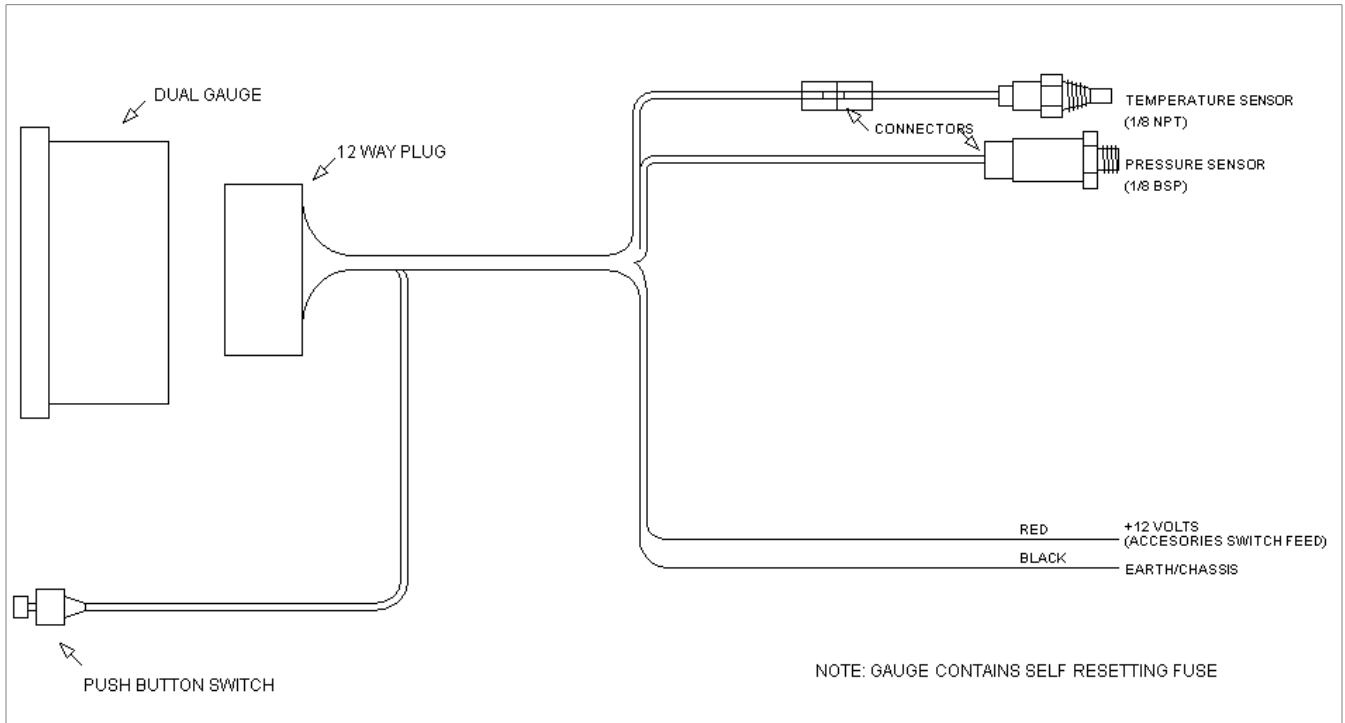

PLEASE NOTE: The black earth wire **MUST** be connected as directly to chassis as possible. It is highly recommended that it not be connected to an earth in the vehicle's loom as this often has a long indirect route to chassis (earth).

12 WAY PLUG

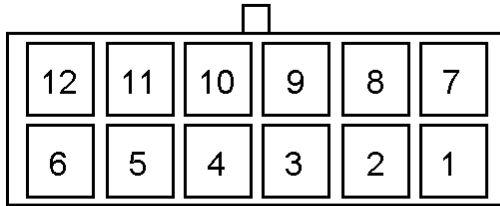

- NOTE 1) 28V MAXIMUM SUPPLY
- NOTE 2) NORMALLY OPEN SWITCH
- NOTE 3) 5V SIGNAL WITH 10K PULL DOWN
- NOTE 4) 250mA MAX LOAD
- NOTE 5) 100mA MAX LOAD

PIN NUMBER	FUNCTION	NOTE
12	GROUND (0V)	
6	+12 VOLTS BATTERY	1,4
8	CHANNEL 1 SENSOR +	
9	CHANNEL 1 SENSOR SIGNAL	3
10	CHANNEL 1 SENSOR -	
5	SWITCH (GROUND)	2
11	SWITCH (SIGNAL)	2
2	CHANNEL 2 SENSOR +	
3	CHANNEL 2 SENSOR SIGNAL	3
4	CHANNEL 2 SENSOR -	
1	EXTERNAL CHANNEL 1 ALARM -	5
7	EXTERNAL CHANNEL 2 ALARM -	5

PRESS SENSOR PLUG US VERSION

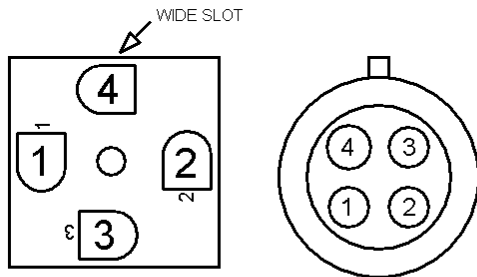

(INSIDE REAR VIEW)

UK PIN No.	US PIN No.	FUNCTION	COLOUR
4	4	GROUND (0V)	GREEN
1	3	PRESSURE SIGNAL	BLACK
2	1	+12V BATTERY	RED
3	NA	BLANKED	NA

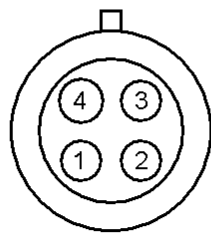

TEMP SENSOR PLUG
(INSIDE REAR VIEW)

PIN NUMBER	FUNCTION	COLOUR
4	GROUND (0V)	GREEN
3	SIGNAL OUT	BLACK
2	+5V SUPPLY	RED
1		NU

THERMOCOUPLE ADAPTOR BOX

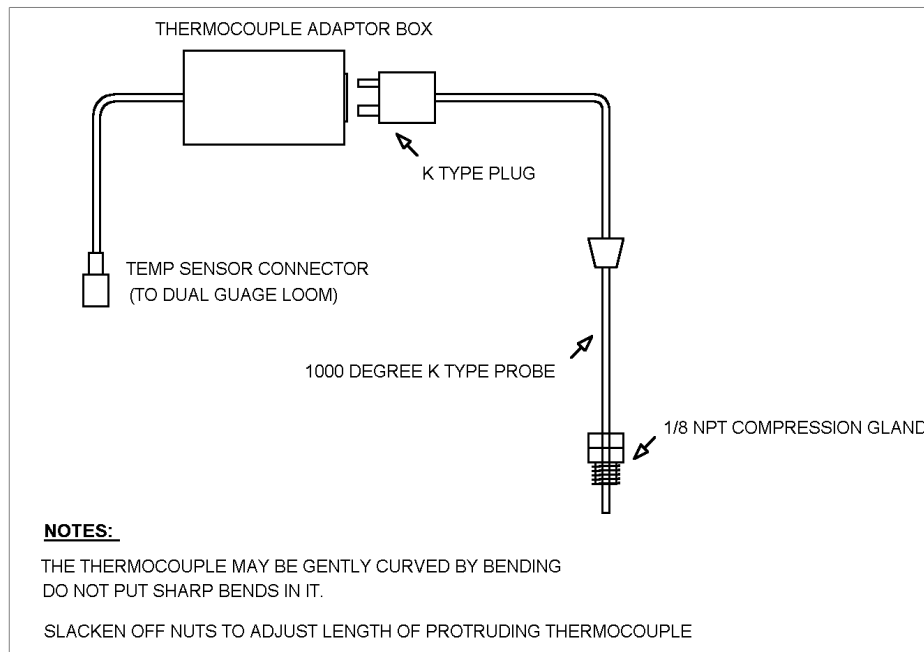

TURBO BOOST SENSOR INSTALLATION

The turbo boost gauge can be installed in a number of different ways, depending on what you wish to measure. Here are two typical ways to install the sensors to measure boost pressure.

INLET MANIFOLD

This is probably the ideal position as the vacuum can be read clearly with the sensors in this position. Here is how to do it:-

- 1) Without removing any engine components (air boxes etc), determine the best position of the pressure sensor so that it can be installed without interfering with any engine components (bear in mind the length of the sensor and connector). Try to choose a relatively flat part of the inlet manifold.
- 2) Remove the inlet manifold. This is recommended as it removes the possibility of swarf entering the engine.
- 3) Drill and tap the inlet manifold with a 1/8 BSP thread. For the dowty washer to seal properly, you will need a flat surface for it to seal onto. If necessary, lightly file and emery a smooth flat onto the manifold.
- 4) After ensuring there is no swarf remaining in the inlet manifold, screw the sensor into the manifold using the dowty seal and refit the inlet manifold to the engine.

TURBO HOSES

When fitted to the turbo hoses, the pressure sensor must be fitted to the *intercooler*. To do this you will need a short length of suitable aluminium tubing to construct a mounting for the pressure sensor.

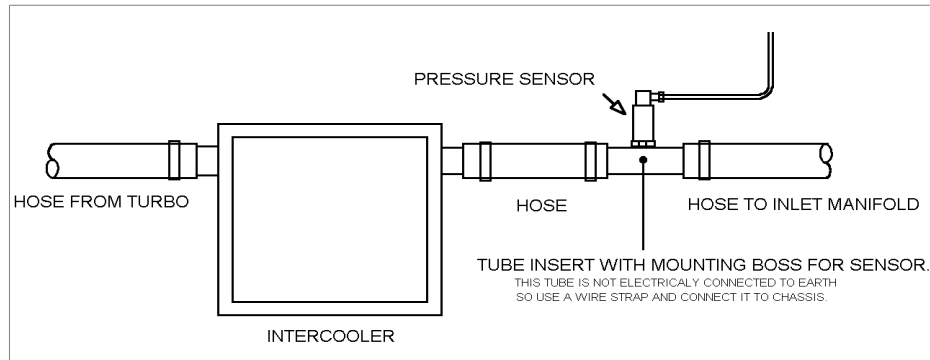

Here is how to do it:-

- 1) A small boss will have to be welded to onto the aluminium tubing. Drill and tap the boss with a 1/8 BSP thread (see 3 inlet manifold method).
- 2) Screw the sensor into the tubes threaded boss using the dowty washer to seal it.
- 3) Ensure that there is no swarf left in the aluminium tubing or boss. Fit the tube into the hose that is coming from the intercooler and going to the inlet manifold.
- 4) Ensure hoses are tight with no air leaks.

Note: Please make sure that the aluminium tubing is connected to chassis to avoid electrical noise and static build up on the sensor body.

Fuel Level / Volts Gauge

The SPA fuel level / volts gauge will interface directly to a standard fuel tank sensor with 5 segments to support shaped tanks. Please connect tank sensor to the gauge as shown in the diagram:-

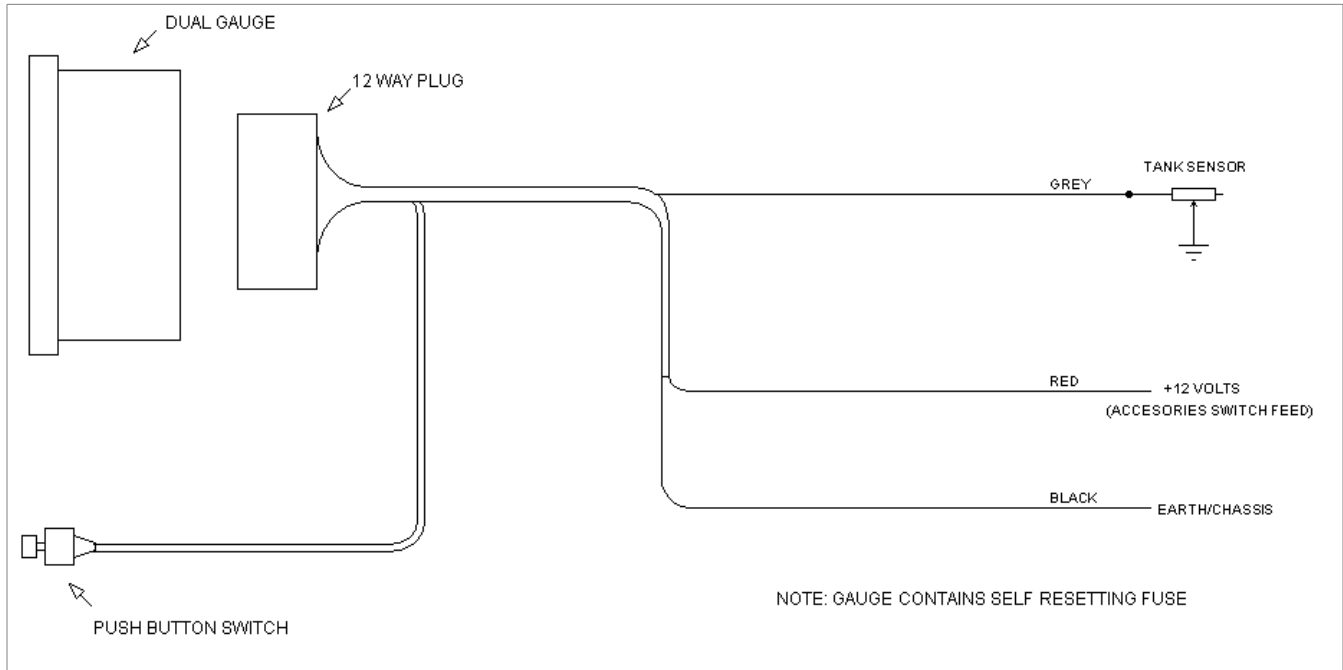

To access the menu, see the section “Menu System” later in this manual. Menu options for the fuel level are:-

Uni Select the units for display. These are in sequence **Lit** (Litres), **GAL** (Gallons) and **PEr** (percentage)

CAP (Capacity) You must enter the capacity of the tank here (how much the tank holds when its full) EG Enter 25 for a tank that holds 25 litres when full. NOTE: Leave this set to 100 if 'Percentage' units are selected.

tSU (Tank Set Up) This is used to setup a 5 point calibration so that any shaped tank will read accurately. Start with the fuel tank empty:-

Tank empty: Enter the tank setup menu item. The display shows segment zero. It can be clicked to segment 0 (empty), 1, 2, 3, 4 and 5 (full) but we are going to start with 0.

Press and hold the button to store the tank empty reading and the gauge returns to Tank setup menu.

Segment 1: Fill the tank to 1/5 of its capacity (20% of the tank full) Hold down the button to access tank setup again this time click to segment 1, press and hold to store (display shows **Sto**).

Segment 2: Fill the tank to 2/5 of its capacity (40% of the tank full) Hold down the button to access tank setup again this time click to segment 2, press and hold to store (display shows **Sto**).

Segment 3: Fill the tank to 3/5 of its capacity (60% of the tank full) Hold down the button to access tank setup again this time click to segment 3, press and hold to store (display shows **Sto**).

Segment 4: Fill the tank to 4/5 of its capacity (80% of the tank full) Hold down the button to access tank setup again this time click to segment 4, press and hold to store (display shows **Sto**).

Tank Full: Fill the tank to its full capacity. Hold down the button to access tank setup again this time click to segment 5, press and hold to store (display shows **Sto**). Tank calibration is now complete, but you can redo any tank segment if you wish.

Next goto menu item **LF** to set the value for your low fuel level warning light. EG 5 for 5 litres.

Next goto menu item **At1** and set the value for the fuel level averaging (10 seconds typical).

Now goto the **rET** menu item to exit the menu system.

CABLE INSTALLATION, DO'S & DON'TS :-

DO'S

DO ensure that the black screened cables do not run next to power cables, especially if they are ignition power cables. Ideally, run all screened cables next to the chassis (earth).

DO ensure that any exposed plugs that are likely to get water spray are protected with rubber boots.

DONT'S

DO NOT allow cables to run through sharp edged apertures without protection.

DO NOT fix the cables next to or onto any surface likely to exceed 80 degrees Centigrade.

INSTRUMENT INSTALLATION DO'S AND DONT'S :-

DO'S

DO ensure that the sensors are screwed into metal that is connected to earth (chassis). If it is not, connect the metal to chassis with a short length of wire.

DO ensure that the instrument is slightly below the drivers head for the clearest view.

DO ensure that the back of the instrument is protected from any water spray that may occur.

DONT'S

DO NOT use a strong Nut-lock adhesive on the screw threads, use only a very light one, or silicone sealant.

OPERATING INSTRUCTIONS

Please ignore features and menu options that do not apply, according to model:-

When the gauge is switched on, it briefly displays the model number (EG SG7) and the type of gauge (EG PrE, tEm) in the main display, and in the TEXT1 and TEXT2 areas the currently selected units and/or degrees setting. This will vary according to model. These units are also displayed when the menu/recall button is pressed. In normal operation the TEXT areas show the programmed text EG “OP” (see alarm section).

The gauge measure and displays the sensors according to factory default setting, but these can be easily customized to your own needs (see menu system section).

All the gauges settings are stored in the gauges memory, these are not lost once the power has been switched off.

The SG300 signature series gauge can display the full range of pressure and temperature reading up to 9999. In high resolution mode (default) x10 resolution is used for readings below 1000. EG Pressure (PSI) can show 0.1 PSI resolution in high resolution mode to 999.9 PSI, and 1 PSI resolution from 1000 to 9999 PSI.

Also the backlight has 7 selectable colours, with adjustable brightness and contrast, and the display operates over a wide temperature range to suit extreme cold and hot climates. The SG7 has high and low text based alarms (“LOW” and “HIGH”) for internal alarms, external for LED or relay alarms, backlight (changes colour) alarms, and a flashing circle general alarm. By default the text, circle, backlight and external alarms activate together. Note: If channel 1 and 2 backlight alarms coincide, then the gauge will flash between the two alarm colours at twice the rate.

The button function can be programmed to access the menu, and/or reset peaks, in addition to recall of maximums.

Because of the many variations in models, please note that the two displays on the gauge are referred to as channel 1 for the top of the display, and channel 2 for the bottom of the display (See below). Also where menu items are duplicated (as in a dual pressure version for example), the number after the menu item refer to their channel. EG Average Time menu items **At1** and **At2** refer to **At1** for channel 1 (top display item), and **At2** for channel 2 (bottom display item).

Please note that there may be some additional or slightly changed menu functions as SPA are enhancing the range continuously. However they all work in a very similar way.

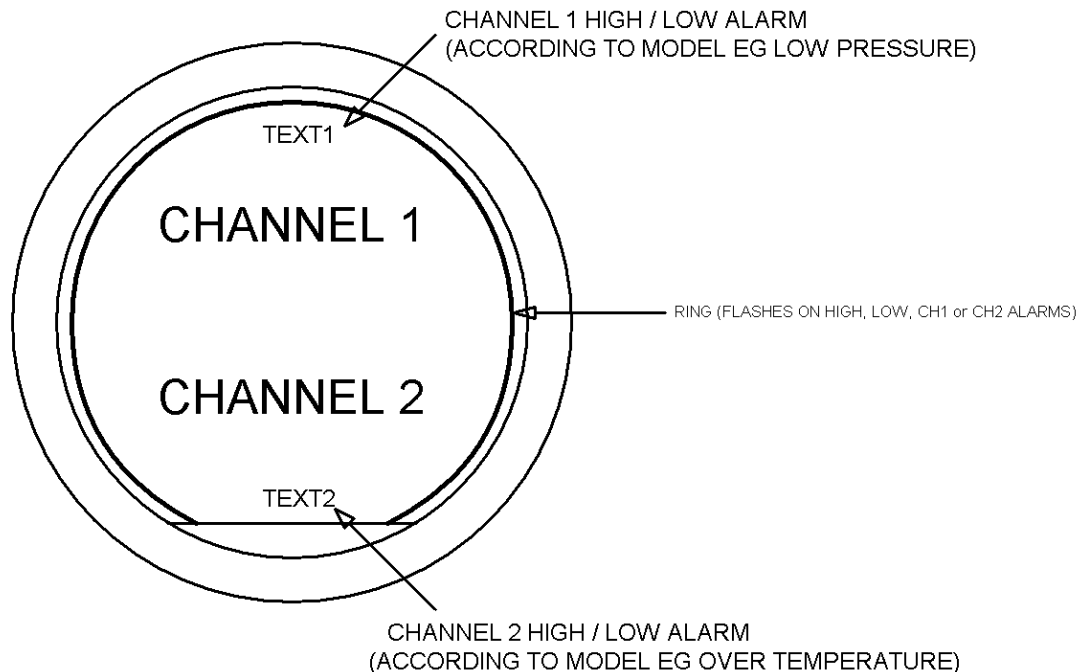

MENU SYSTEM

To access the gauge system menu, you can either hold down the red button while you switch on the power, or if the menu is configured for button access (factory default), press and hold down the red button for more than 5 seconds. On the display you will see **tSt** on the LCD display. Now release the button. If you now press the button momentarily again you will see the display change to the next menu option. Keep pressing the button to familiarize yourself with the menu items.

The SG7 gauge also uses the TEXT1, and TEXT2 areas to show the current menu setting so you can see the current values (if applicable) as you click through the menus. A brief sequential view of options and their meaning is shown below:-

Display shows:	What it does:
tSt	Used by SPA during production (ignore).
bL	Set the backlight to off, red, green, blue, amber, magenta, cyan, white.
hUE	Adjust the backlight colour hue manually.
bri	Use this to set the backlight brightness.
Con	Use this to set the LCD contrast.
SEt	Demo modes (ignore)
rtP	Use this to reset the stored maximums (peaks).
oFF	Use this to read the sensor and 'zero' it (pressure only).
dEg	Use this to set temperature display units.
Uni	Use this to set pressure display units.
ALA	Use this to set the gauges high and low alarm and text settings
Lb	Use this to set the low battery warning setting.
At	Use this to set the averaging time for the channel 1 sensors (top of display).
tyP	Use this to set type of temperature sensor.
EFL	Use this to set external alarms to flashing.
hr1	Use this to set the resolution of channel 1 (EG pressure).
hr2	Use this to set the resolution of channel 2 (EG temperature).
SFU	Use this to set the switch function of the red button.
Eng	Use this to access special menu function (see appendix).
rEt	Use this to exit the menu and return to normal gauge operation. Do not switch the gauge off after changing a menu setting. Always click onto the next menu item before switching off.

Press again and the menu will go back to **tSt**.

A detailed breakdown of the gauge menu options is shown on the following pages:-

tSt This is used by SPA during production. If you really want to see what it does, Press and hold down the red button. After 2 seconds the LCD lights up all segments and flashes the RGB colours. To return to the menu, click the button.

bL Press and hold down the red button. After 2 seconds, the current backlight colour will be displayed. Single click to change to red, green, blue, amber, magenta, cyan, white or off. To return to the menu, leave the button for 4 seconds.

hUE The percentage of red, green and blue can be adjusted here, although it is recommended that you use the pre-defined colours in the bL menu above. Please note that the range of colour is limited by the colour of the LED's. To use this menu, you need to understand that all three colours slices make up a 100% colour space "pie". So increasing one colour, has to reduce another colour because the total is always 100%. This is hard to adjust without a computer, so this is how it works here. The sequence for the correct setting of the colour is: red percentage, green percentage and whatever is left over from 100% is blue percentage. When you increase red, it will reduce blue until blue is zero, then it will reduce the green until red is 100%. When you increase green, it will reduce blue but it will not reduce the red. It is best to decide beforehand what colour percentage ratios you want and/or which colour you want to change, and set them in the order: red, green and (by default) blue. So to set the white colour (R=60%, G=30%, B=10%) for example:-
Press and hold down the red button. After 2 seconds, "red" will be displayed. Wait for 4 seconds and the current red % setting is displayed. Click to change this to 60%. Wait for 4 seconds for the display to return to Hue. Press and hold again, but when red appears, click to change to grn. Wait for 4 seconds and click to change the value to 30%. Now we have set the red to 60%, the green to 30%, and the remaining 10% is blue. This does not affect the alarm colours. If you want to return to a standard colour, use the bL menu above.

bri Press and hold down the red button. After 2 seconds, the current brightness number will be displayed. Single click to increment (lighten) the LCD backlight, or press and hold again for 2 seconds and the brightness number will count up quickly. When the number reaches 100% it will go back to 5% (dark). To return to the menu, leave the button for 4 seconds.

Con Press and hold down the red button. After 2 seconds, the current contrast number will be displayed. Single click to increment (Darken) the LCD contrast, or press and hold again for 2 seconds and the contrast number will count up quickly. When the number reaches 100 it will go back to 0 (light). To return to the menu, leave the button for 4 seconds. Also when this number is higher, the LCD can be viewed at slightly lower angles.

SEt Sets the demo modes for demo displays panels. Must be set to **oFF** for normal operation. Press and hold down the red button. After 2 seconds, the display will show the current demo selection. Single click to change, then leave for 4 seconds to return to the menu.

rSt Press and hold down the red button. After 2 seconds the display will show ---. All maximum data is now reset.

oFF Use this to 'zero' pressure sensors and custom sensors (see appendix), and read the voltage output of any sensor. This routine can read the offset value of the pressure sensor and store it, so that the sensor will read 'zero' at normal atmospheric pressure. To select which channel to read and 'zero' it, press and hold down the red button. After 2 seconds the display will show '1' corresponding to the sensor channel number 1 (corresponding the top line of the LCD display). Single click to select the channel number you wish. Now release the button and after 4 seconds the display will show the output voltage of the sensor selected (according to the channel number). This represents the sensor output voltage at its minimum in Volts. EG 1.00 V for a standard SPA 16 Bar pressure sensor. (1-5 volts output)

To 'zero' the pressure sensor, press and hold down the red button. After 2 seconds, the display will change to --- and the displayed offset value will be stored. Wait for the display to return to **oFF**.

Note: Although you can use this function to view the output voltage of any sensor, you are only allowed to 'zero' pressure sensor channels. Other sensor channels will display **NA** (not applicable) if you try to zero them.

dEg Press and hold down the red button. After 2 seconds, the display will show the current selection for temperature degrees. These are in **C**entigrade, and **F**ahrenheit. Single click to change the current selection. After changing the degrees, you will need to redo your temperature alarm set points as they will be reset to standard (105 Degrees C equivalent in whatever degrees are selected).
To return to the menu, leave the button for 4 seconds.

Uni Press and hold down the red button. After 2 seconds, the display will show the current pressure units selection. These are in sequence **PSI**, **BAr** and **CM2 (KGCM)**, **inhg (inHg)**, and **PA (kPa)**. Single click to change the current selection. After changing the units, you will need to redo your pressure alarm set points as they will be reset to standard defaults (25 PSI equivalent in whatever units are selected). To return to the menu, leave the button for 4 seconds.

ALA (Note: for ALA only, the two values in TEXT1 and TEXT2 area show the values of the main hi and lo alarms) To select which channel to read and view or set the alarms, press and hold down the red button. After 2 seconds the display will show **Ch1** corresponding to the sensor channel number 1 (corresponding the top line of the LCD display). Single click to select the channel number you wish. Now release the button and after 4 seconds the display will show the Alarm sub menu items (the channel number is shown on the TEXT2 area during these sub menus, except on the **LEt** menu when it is moved to the top TEXT1 area) :-

Lo When activated, this alarm will flash **LOW** in the text area and flash the circle. To change this alarm, Press and hold down the red button. After 2 seconds, the current channel low alarm set point will be displayed. Single click to increment up, or press and hold again for 2 seconds and the set point will count up quickly. When the set point number reaches the full scale it will go back to 0 (zero alarm setting switches it off). To return to the menu, leave the button for 4 seconds.

hi As above, but for High Alarm and will flash **HIGH** in the text area and flash the circle.

CPy Copy function. Activating this, will copy the alarm **Lo** and **hi** settings to the **bLo**, **bhi**, **Elo** and **Ehi** for the current channel. This keeps all the alarms in sync, which is the default factory configuration. Press and hold the red button to activate, after 2 seconds it will show **donE**.

LEt Sets the individual letters for the text in the TEXT area for the current channel. The text is always show in the bottom TEXT2 area for this sub menu, but will appear in the correct position for the channel for normal gauge operation. EG if Ch1 is selected for an Oil (pressure) Water (temperature) gauge, then bottom TEXT2 area would show **OP**. Please note that using less than 4 letters needs padding with a space (blank) character. In this case, “**OP**” is actually “ **OP** “, this means that letter 1 and letter 4 are a set to the “space” character.

To select the letter number to change (EG in the above example: “space” is letter number 1, and **O** is letter number 2) press and hold the red button. After 2 seconds the display will show **LEt1**. Single click to change the number, and then leave for 4 seconds. The display will then show the channel text in the TEXT2 area, and the letter number you selected to change will flash with a cursor. You can single click to change the letter, or press and hold for it to scroll quickly. There are a lot of characters, number and letters to go through , they begin with “space” then

! ” # \$ % & ' () * + , - . / 0123456789 : ; < = > ? @ ABCDEFGHIJKLMNOPQRSTUVWXYZ [Y] ^ _ \ abcdefghijklmnopqrstuvwxyz

Then back around to “space” after clicking past “z”. This is called standard ASCII text, if you want to use the full range including the extended ASCII text, then you need to enable it in the engineering menu (see appendix). To view the full character set more clearly, see the online document at www.spa-uk.co.uk/support/dualgauges. But please be aware that its quite hard to keep track of which characters you are clicking through in Extended mode as there are many obscure characters.

bLo As above, but for backlight Low alarm. This will cause the backlight to flash with the colour set below. Setting to zero disables this alarm function.

Clo Sets the colour for the backlight Low alarm. Press and hold down the red button. After 2 seconds, the current backlight alarm colour will be displayed. Single click to change to red, green, blue, amber, magenta, cyan or white. To return to the menu, leave the button for 4 seconds. Please note that the menu will not stop you setting the alarm to the same colour as the backlight, or another backlight alarm, so please take care to set the correct colour.

bhi As above, but for backlight High alarm. This will cause the backlight to flash with the colour set below.

Chi Sets the colour for the backlight High alarm, see **bLo** above.

ELo As above, but for External Low Alarm

Ehi As above, but for External High Alarm.

iLS Inhibit Low alarm at Startup. This feature allows you to stop the low alarm showing at power on (startup). If this is selected to "On", then the low alarm will only be activated after it has first gone above the low alarm setting. If you want the alarm to come on straight away, then set this feature to "Off". Press and hold down the red button. After 2 seconds, the current option will be displayed. Single click to change to On or Off. To return to the menu, leave the button for 4 seconds.

Single click again and you will exit the sub menu system and return to menu **ALA**.

Lb Press and hold down the red button. After 2 seconds, the current low battery warning set point will be displayed. Single click to increment up, or press and hold again for 2 seconds and the set point will count up quickly. When the set point number reaches the 15.0 it will go back to 10.0. To return to the menu, leave the button for 4 seconds.

At Press and hold down the red button. After 2 seconds, the current pressure averaging time will be displayed. Single click to increment up, or press and hold again for 2 seconds and the set point will count up quickly. When the set point number reaches 25.0 it will go back to 0.1 (0.1 switches averaging off). To return to the menu, leave the button for 4 seconds.

tyP Press and hold down the red button. After 2 seconds, the display will show the current selection for temperature sensor type. These are in sequence **tEM** (SPA semiconductor temperature sensor), **tHr** (thermistor based sensor), **tHi** (1000 degree thermocouple option), **tLo** (255 degree thermocouple option) and **tEH** (1200 degree extra high thermocouple option). Single click to change the current selection. To return to the menu, leave the button for 4 seconds.

EFL (External flash on/off):- Press and hold down the red button, after 2 seconds display changes to the desired option. Use this to switch off external flashing if you wish to have the external warnings (or other devices) activate but without flashing.

hr1 (High Resolution channel 1 on/off):- Press and hold down the red button, after 2 seconds display changes to the desired option. Use this to switch off the high resolution (x10 zoom) feature for channel 1. With this switched on, the display will show 10 times more resolution and auto scales for higher readings. EG in Low resolution mode pressure is displayed as 00 to 9999 PSI. In high resolution mode pressure is displayed as 0.0 to 999.9 PSI, and above this pressure range as 1000 to 9999 PSI.

hr2 (High Resolution channel 2 on/off):- Press and hold down the red button, after 2 seconds display changes to the desired option. Use this to switch off the high resolution (x10 Zoom) feature for channel 2. With this switched on, the display will show 10 times more resolution and auto scales for higher readings. EG in Low resolution mode temperature is displayed as 00 to 9999 degrees. In high resolution mode temperature is displayed as 0.0 to 999.9 degrees, and above this temperature range as 1000 to 9999 degrees.

SFU Press and hold down the red button. After 2 seconds, the display will show the current selection for the switch function (what happens when you hold down the red button in normal gauge operation). These are in sequence **rMU** (recall maximums and after 5 seconds access the menu), **rCL** (recall maximums only) and **rrS** (recall maximums and after 5 seconds reset maximums). Single click to change the current selection. To return to the menu, leave the button for 4 seconds.

Eng For engineering access (code protected)

rEt Press and hold down the red button. After 2 seconds, the display will show --- . Release the button and the gauge will restart normally.

Flashing text:-

LOW The reading is at or below the programmed set point.

HIGH The reading is above the programmed set point.

LOW + BATT = Low Battery volts. The Instrument supply voltage is below the low battery set point. If the supply goes below 7.5 volts the instrument resets itself.

OTHER WARNING MESSAGES :-

FL = FauLt. The sensor output voltage is below normal parameters, so it has become unplugged, damaged, or wiring to the sensor is disconnected or faulty. (Not applicable to thermocouples).

Warning alarms by default are accompanied by slow flashing backlight colour and circle except the turbo boost which flashes very fast for over boost and shows **TBST** as text.

The warning lights are also available externally via the socket.(see wiring diagram) External LEDs or relays can be connected, and these can be programmed to activate independently of the internal LEDs, and programmed for flash or direct drive.

SPECIFICATIONS:-

INPUT VOLTAGE 10-16 VOLTS (28v Absolute max, pulse only)
CONSUMPTION 35 mA @ 12v, 45mA @ 14v (60% brightness)

ACCURACY:-

PRESSURE Better than 2%@ 232 PSI (1 PSI = 0.069 BAR)

TEMPERATURE Better than +/- 2 °C from -55 to +150°C

VOLTAGE +/- 0.1v over 9-16 volts.

CALIBRATION:- Digital

DATA STORAGE:- Flash

WEIGHT:- 325g Including sensors,cables,etc

SIZE:- 52mm DIA x 30mm (Bezel 58mm DIA)

SENSORS FIXING THREADS:-

Temperature: 1/8 NPT 12.7mm long

Pressure: 16 Bar: 1/8 BSP x 12.7mm, 200 Bar: M14 x 1.5P (O ring seals included)

CABLE LENGTHS:- Pressure & Temperature - 108"

Power supply - 12"

Switch lead - 24"

ABSOLUTE MAXIMUM RATINGS:-

INPUT VOLTAGE: 28 VOLTS (pulse only)

MAX PRESSURE: 232 PSI (for 16 BAR sensor)

2900 PSI (for 200 BAR sensor)

PROOF PRESSURE = 2 times max pressure

TEMPERATURE - 150°C (brass sensor), 255/1000/1200 °C (thermocouples)

INSTRUMENT TEMPERATURE -20 to +70°C

Appendix

A) External alarm outputs

The external alarm outputs can drive loads up to 100mA. **DO NOT** use ordinary bulbs as these take much more than 100mA and will damage the gauge.

To fit an external LED, please use a **12v type**. These have a built in current limiting resistor and will only draw around 25mA. See diagram below:-

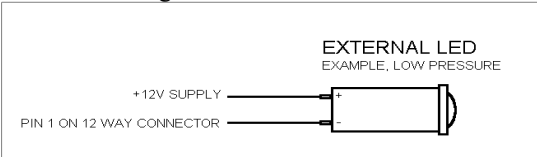

You can order 10mm panel mount leds, complete with wire tails and pins from SPA Design or via your local SPA distributor.

To drive control relays, you need to select a relays of more than 120 Ohms coil resistance (so it draws less than 100mA). You will also **MUST** use a protection diode to clamp the high voltage back EMF resulting from the relay coil when it is de-energised. Please follow the diagram below:-Relay Suggestion:-

Omron G2R-1-T DC12
RS stock code 211-1269

1N4001 diode
RS stock code 628-8931

Quick connect female crimp 4.8mm
RS stock code 488-1229

Insulating sleeve
RS stock code 488-1285

3.2mm Clear heat shrink
RS stock code 170-6591

Cut down the 1N4001 diode leads to around 10mm and solder to approx 60 mm of equipment wire, 0.5sq.mm. Insulate the diode and leads with approx 50mm of clear heat shrink tubing.

Connect the diode and wires to the the female crimp connectors as shown. Make sure that the banded end of the diode is connected to +12v or else the Dual Gauge will be damaged.

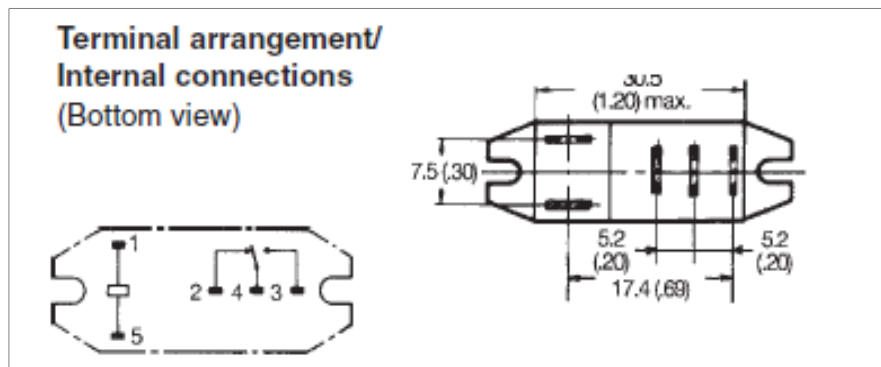

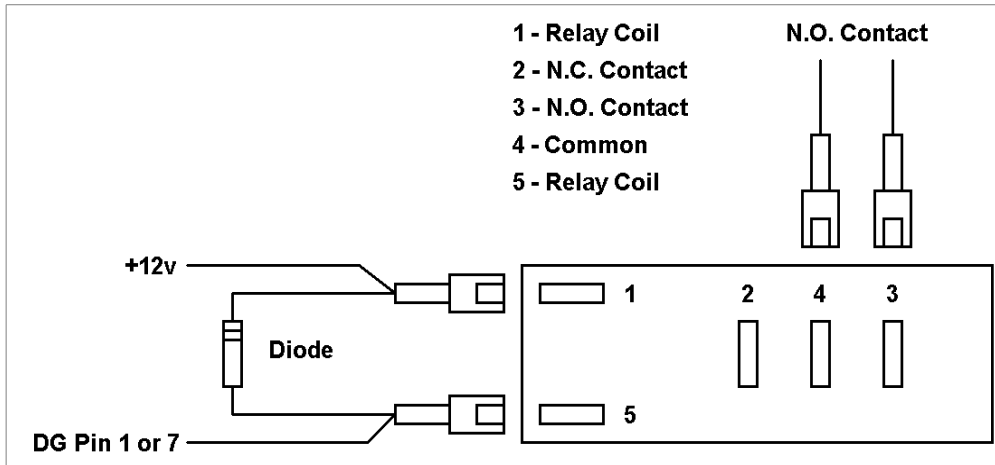

To avoid the relay pulsing on and off with the flashing alarm, you must set the **EFL** (external flash) to **oFF** (see menu section).

B) Special Engineering Menu section

To access the special menu area you need to enter a code in the **Eng** menu item. Goto the **Eng** menu item. Press and hold down the button for 2 seconds and the display shows to 000. Press and hold to scroll the number to 113. Wait for 4 seconds, and then the special menus will appear:-

dbA Dead band control:- If the pressure value to be displayed is less than the dead band value (whether positive or negative) the display is set to zero. This is to avoid displaying low level drift and flicker which some customers find annoying. The factory default for this is 1, but can be increased to a maximum of 10 if desired.

Etd (EXTD) Extended ASCII characters. Press and hold the red button to enable (**on**), or disable (**oFF**).

ChA This is a sub menu system for changing the scaling and unit parameters for custom sensor set-ups. You cannot change the type of sensor as this is determined by the construction and labelling of the gauge itself, but you could replace the SPA pressure sensor with another pressure sensor for example.

To access these parameters, first you select the analog channel that you wish to setup, and then you are taken through a series of sub menus for that channel. The setup is identical for both channels.

Press and hold down the red button. After 2 seconds, the display will show (channel) 1. Single click to increment the channel number to the desired channel. When you have selected the channel, leave the button for 4 seconds and the display will change to **FSC**. This is the first of 4 sub menus.

All sub menus work in the same way. To access each one press and hold down the left button, after two seconds the current setting will be displayed. Now single click to select, or press and hold to count up.

If you do not wish to access the sub menu, just single click and the next one will be displayed.

Here is a list of all sub menus and their function: -

- FSC** Use this to change the default full-scale sensor setting.
- dEC** Use this to change the default decimal point setting (none, 1 or 2 places).
- SPn** Use this to change the default span sensor setting.
- oFF** Use this to change the default offset sensor setting.
- SFL** Use this to change the sensor fault mV threshold.

For thermistor sensors the functions are different:-

- FSC** Set to 10 for Centigrade, 18 for Fahrenheit.

dEC Set to zero.
SPn Set to the RT2 value (Ohms)
oFF Set to the first three digits of the B value

If you single click again, you will return to the **ChA** menu item.
Here is a break down of each sub menu item: -

FSC, Press and hold down the red button. After 2 seconds, the full-scale number will be displayed. This represents the value to display when the sensor output voltage is at maximum. EG 232 PSI for a standard SPA 16 Bar pressure sensor. Single click to increment up, or press and hold again for 2 seconds and the alarm number will count up quickly. When the number reaches 9999 it will go back to 1. To return to the sub menu, leave the button for 4 seconds.

dEC, Press and hold down the red button. After 2 seconds, the current decimal point number will be displayed. Single click to increment up. When the number reaches 2 it will go back to 0 (no decimal point). NOTE: If you set a decimal point of 2, and have High resolution switched on (IE 3 decimal places will be shown), then no negative readings are allowed. To return to the sub menu, leave the button for 4 seconds.

SPn Press and hold down the red button. After 2 seconds, the full-scale span number will be displayed. This represents the sensor output voltage swing at maximum in Volts. EG 4.00 V at 232 PSI for a standard SPA 16 Bar pressure sensor. (1-5 volts output)
Single click to increment up, or press and hold again for 2 seconds and the span number will count up quickly. When the number reaches 5.00 it will go back to 1. To return to the sub menu, leave the button for 4 seconds.

oFF, Press and hold down the red button. After 2 seconds, the offset number will be displayed. This represents the sensor output voltage at minimum in Volts. EG 1.00 V for a standard SPA 16 Bar pressure sensor. (1-5 volts output)
Single click to increment up, or press and hold again for 2 seconds and the span number will count up quickly. When the number reaches 5.00 it will go back to 1. To return to the sub menu, leave the button for 4 seconds.

SFL, Press and hold down the red button. After two seconds the sensor fault threshold will be displayed in mV. **Do not change this value for SPA sensors.** Setting this value to zero disables the sensor fault warning.

tEM For SPA use, shows the internal temperature of the gauge.

If you single click again, you will return to the **ChA** menu item.

NOTE: You must not change the Units or Degrees or Type (**Uni**, **dEg** or **tyP** menu's) after setting up the above channel parameters. If you do, this will restore default channel parameters for SPA sensors. Of course if you wish to restore standard parameters, then simply use these menus as appropriate to reset them.

Brake Bias Kit Addendum

PRESSURE SENSOR INSTALLATION:-

Install one of the 4 way adapters in the front brake line, and the other one in the rear brake line. Screw in the pressure sensors to the bottom port of the 4 way 3/8-24 UNF adapters using the supplied Dowty seals. Then use the bleed nipples (on the top port of the adapters) to bleed the air out of the adapters. If you screw the bleed nipples out temporarily, you can fill up the 4 way adapters with brake fluid to purge out most of the air. Then bleed the rest of the brake system in the normal way.

If you spill brake fluid onto the sensor cable or connectors, make sure that you wipe it off thoroughly.

Push on the sensor plugs as shown on the schematic.

THE PLUG WILL ONLY GO ON ONE WAY, REFER TO SCHEMATIC DIAGRAM.

Then tighten the central screw on the plugs. Do not over tighten, they have a rubber gasket that will seal to IP65 specification. Please use the menu option **oFF** (see dual gauge manual) to zero each sensor after installation.

PRESSURE SENSOR INSTALLATION

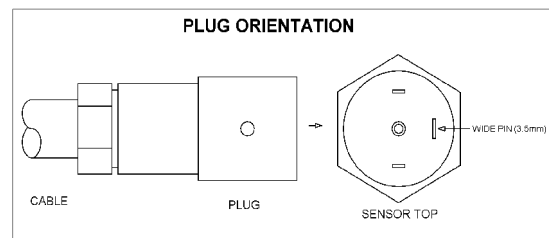
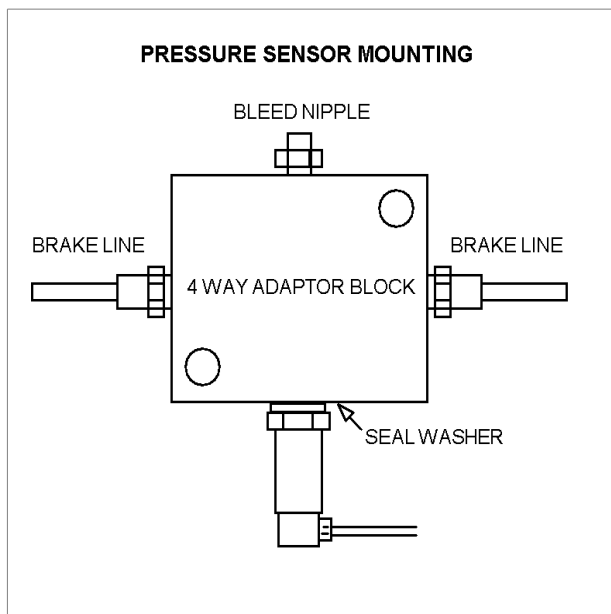

There two extra menu items for the brake bias kit not in the standard dual gauge manual:-

rCP (Recall peaks) Press and hold down the red button. After 2 seconds the display will show the maximum pressures stored since the last reset operation (see **rtP** in manual)

PE (Peak ratio) Press and hold down the red button. After 2 seconds the display will show **rAt** ratio for the maximum pressures stored above.

Also the standard **SFU** menu item has been replaced with **vIE** and a special **SFU** and works as follows:-

vIE (View):- This is used to select what is viewed on the brake bias LCD, and what the view changes to when the red button is pressed. If **PrE** is selected, then the LCD normally shows pressure, and then shows percent bias when the red button is pressed. If **bIA** is selected, then the LCD normally shows percent bias, and then shows pressure when the red button is pressed. To change the view selection, press and hold down the red button, after 2 seconds display changes to the desired option.

SFU Press and hold down the red button. After 2 seconds, the display will show the current selection for the switch function (what happens when you hold down the red button in normal gauge operation). These are in sequence **vIE** (view

pressure/bias only), and vME (view pressure/bias and after 5 seconds access the menu). Single click to change the current selection. To return to the menu, leave the button for 4 seconds.

Extended ASCII character table

	0	1	2	3	4	5	6		-	.		
!		A	B	C	D	E	F		7	8	9	
"		Z	B	R	b	r	e	E				
#		3	C	S	c	s	a	a				
\$		4	D	T	d	t	a	a				
%		5	E	U	e	u	a	a				
&		6	F	V	f	v	a	a				
'		7	G	W	g	w	s	u				
(8	H	X	h	x	e	g				
)		9	I	Y	i	y	e	o				
*			J	Z	j	z	e	o				
+			K	L	k	l	i	a				
,			L									
-			N	I	n							
.			N	^	n							
/			0	L	o	e	a	a				