



**BUILT-IN COMBINATION STEAM OVEN
WITH HOT AIR AND MICROWAVE
OPERATION MANUAL**

MODEL:TR936T4CR

Read these instructions carefully before using your microwave oven, and keep it carefully.

If you follow the instructions, your oven will provide you with many years of good service.

SAVE THESE INSTRUCTIONS CAREFULLY

CONTENTS

CONTENTS	2
PRECAUTIONS TO AVOID POSSIBLE EXPOSURE TO EXCESSIVE MICROWAVE ENERGY	3
ADDENDUM	3
SPECIFICATIONS	4
IMPORTANT SAFETY INSTRUCTION	5-9
TO REDUCE THE RISK OF INJURY TO PERSONS GROUNDING INSTALLATION	10-12
SETTING UP YOUR OVEN	12
IMPORTANT INFORMATION ABOUT INSTALLING	13
FITTED UNITS	14
INSTALLATION DIMENSIONS	14
BUILDING IN	14
ELECTRICAL CONNECTION	15
BEFORE FIRST USE	16
OPERATION INSTRUCTION	17-34
TROUBLESHOOTING	

PRECAUTIONS TO AVOID POSSIBLE EXPOSURE TO EXCESSIVE MICROWAVE ENERGY

- (a) Do not attempt to operate this oven with the door open since this can result in harmful exposure to microwave energy. It is important not to break or tamper with the safety interlocks.
- (b) Do not place any object between the oven front face and the door or allow soil or cleaner residue to accumulate on sealing surfaces.
- (c) **WARNING:** If the door or door seals are damaged, the oven must not be operated until it has been repaired by a competent person.

ADDENDUM

If the apparatus is not maintained in a good state of cleanliness, its surface could be degraded and affect the lifespan of the apparatus and lead to a dangerous situation.

Specifications

Model:	TR936T4CR
Rated Voltage:	240V~50Hz
Rated Input Power(Microwave):	1550W
Rated Output Power(Microwave):	900W
Rated Output Power(Grill):	1300W
Rated Output Power(Convection):	1900W
Rated Power(Steam):	1500W
Rated Power(Maximum):	3000W

IMPORTANT SAFETY INSTRUCTIONS

IMPORTANT SAFETY INSTRUCTIONS

WARNING

To reduce the risk of fire, electric shock, injury to persons or exposure to excessive microwave oven energy when using your appliance, follow basic precautions, including the following:

1. Read and follow the specific: "PRECAUTIONS TO AVOID POSSIBLE EXPOSURE TO EXCESSIVE MICROWAVE ENERGY".
2. This appliance can be used by children aged from 8 years and above and persons with reduced physical, sensory or mental capabilities or lack of experience and knowledge if they have been given supervision or instruction concerning use of the appliance in a safe way and understand the hazards involved. Children shall not play with the appliance. Cleaning and user maintenance shall not be made by children unless they are older than 8 and supervised. Children less than 8 years of age shall be kept away unless continuously supervised.
3. Keep the appliance and its cord out of reach of children less than 8 years.
4. If the supply cord is damaged, it must be replaced by the manufacturer, its service agent or similarly qualified persons in order to avoid a hazard. (For appliance with type Y attachment)
5. **WARNING:** Ensure that the appliance is switched off before replacing the lamp to avoid the possibility of electric shock.

6. WARNING: If the door or door seals are damaged, the oven must not be operated until it has been repaired by a competent person.
7. WARNING: It is hazardous for anyone other than a competent person to carry out any service or repair operation that involves the removal of a cover which gives protection against exposure to microwave energy.
8. WARNING: Liquids and other foods must not be heated in sealed containers since they are liable to explode.
9. When heating food in plastic or paper containers, keep an eye on the oven due to the possibility of ignition.
10. Only use utensils that are suitable for use in microwave ovens.
11. If smoke is emitted, switch off or unplug the appliance and keep the door closed in order to stifle any flames.
12. Microwave heating of beverages can result in delayed eruptive boiling, therefore care must be taken when handling the container.
13. The contents of feeding bottles and baby food jars shall be stirred or shaken and the temperature checked before consumption, in order to avoid burns.
14. Eggs in their shell and whole hard-boiled eggs should not be heated in microwave ovens since they may explode, even after microwave heating has ended.

15. The oven should be cleaned regularly and any food deposits removed.

16. Failure to maintain the oven in a clean condition could lead to deterioration of the surface that could adversely affect the life of the appliance and possibly result in a hazardous situation.

17. Only use the temperature probe recommended for this oven. (for ovens provided with a facility to use a temperature-sensing probe.)

18. The microwave oven must be operated with the decorative door open. (for ovens with a decorative door.)

19. This appliance is intended to be used in household and similar applications such as:

- staff kitchen areas in shops, offices and other working environments;

- by clients in hotels, motels and other residential type environments;

- farm houses;

- bed and breakfast type environments.

20. The microwave oven is intended for heating food and beverages. Drying of food or clothing and heating of warming pads, slippers, sponges, damp cloth and similar may lead to risk of injury, ignition or fire.

21. Metallic containers for food and beverages are not allowed during microwave cooking.

22. The appliance shall not be cleaned with a steam cleaner.

23. The microwave oven is intended to be used built-in.

24. **WARNING:** When the appliance is operated in the combination mode, children should only use the oven under adult supervision due to the temperatures generated.
25. Care should be taken not to displace the turntable when removing containers from the appliance. (For fixed appliances and built-in appliances being used equal or higher than 900mm above the floor and having detachable turntables. But this is not applicable for appliances with horizontal bottom hinged door.)
26. Steam cleaner is not to be used.
27. Surface of a storage drawer can get hot.
28. **WARNING:** The appliance and its accessible parts become hot during use. Care should be taken to avoid touching heating elements. Children less than 8 years of age shall be kept away unless continuously supervised.
29. During use the appliance becomes hot. Care should be taken to avoid touching heating elements inside the oven.
30. **WARNING:** Accessible parts may become hot during use. Young children should be kept away.
31. The appliance must not be installed behind a decorative door in order to avoid overheating. (This is not applicable for appliances with decorative door.)
32. Do not use harsh abrasive cleaners or sharp metal scrapers to clean the oven door glass since they can scratch the surface, which may result in shattering of the glass.
33. **WARNING:** When move the oven, do not carry handle. (Oven is overweight, handles are easily broken.)

34. The water in the receiving tank, inside the oven and in the water tank should be cleaned up after each use.

35. Do not use the paper cups and plastic containers with temperature resistance below 120 degrees. The glass, ceramic, stainless steel utensils can be used.

36. Steam is the main heating function for this product.

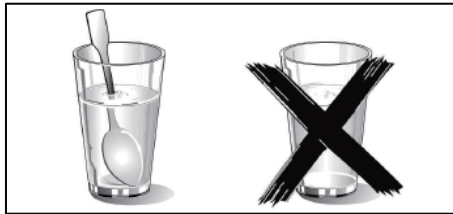

- o If you are heating liquid in the microwave, then you must also place a teaspoon in the container. This will ensure that the liquid does not boil suddenly after being removed from the microwave cavity.

READ CAREFULLY AND KEEP FOR FUTURE REFERENCE

To Reduce the Risk of Injury to Persons Grounding Installation

DANGER

Electric Shock Hazard

Touching some of the internal components can cause serious personal injury or death.

Do not disassemble this appliance.

WARNING

Electric Shock Hazard

Improper use of the grounding can result in electric shock. Do not plug into an outlet until appliance is properly installed and grounded.

This appliance must be grounded. In the event of an electrical short circuit, grounding reduces the risk of electric shock by providing an escape wire for the electric current. This appliance is equipped with a cord having a grounding wire with a grounding plug. The plug must be plugged into an outlet that is properly installed and grounded.

Consult a qualified electrician or serviceman if the grounding instructions are not completely understood or if doubt exists as to whether the appliance is properly grounded. If it is necessary to use an extension cord, use only a 3-wire extension cord.

1. A short power-supply cord is provided to reduce the risks resulting from becoming entangled in or tripping over a longer cord.
2. If a long cord set or extension cord is used:
 - 1)The marked electrical rating of the cord set or extension cord should be at least as great as the electrical rating of the appliance.

- 2)The extension cord must be a grounding-type 3-wire cord.

- 3)The long cord should be arranged so that it will not drape over the counter top or tabletop where it can be pulled on by children or tripped over unintentionally.

CLEANING

Be sure to unplug the appliance from the power supply.

1. Clean the cavity of the oven after using with a slightly damp cloth.
2. Clean the accessories in the usual way in soapy water.
3. The door frame and seal and neighbouring parts must be cleaned carefully with a damp cloth when they are dirty.
4. Do not use harsh abrasive cleaners or sharp metal scrapers to clean the oven door glass since they can scratch the surface, which may result in shattering of the glass.
5. Cleaning Tip---For easier cleaning of the cavity walls that the food cooked can touch:

Place half a lemon in a bowl, add 300ml (1/2 pint) water and heat on 100% microwave power for 10 minutes.

Wipe the oven clean using a soft, dry cloth.

UTENSILS

CAUTION

Personal Injury Hazard

It is hazardous for anyone other than a competent person to carry out any service or repair operation that involves the removal of a cover which gives protection against exposure to microwave energy.

See the instructions on "Materials you can use in microwave oven or to be avoided in microwave oven."

There may be certain non-metallic utensils that are not safe to use for microwaving. If in doubt, you can test the utensil in question following the procedure below.

Utensil Test:

1. Fill a microwave-safe container with 1 cup of cold water (250ml) along with the utensil in question.
2. Cook on maximum power for 1 minute.
3. Carefully feel the utensil. If the empty utensil is warm, do not use it for microwave cooking.
4. Do not exceed 1 minute cooking time.

Materials you can use in microwave oven

Utensils	Remarks
Browning dish	Follow manufacturer's instructions. The bottom of browning dish must be at least 3/16 inch (5mm) above the turntable. Incorrect usage may cause the turntable to break.
Dinnerware	Microwave-safe only. Follow manufacturer's instructions. Do not use cracked or chipped dishes.
Glass jars	Always remove lid. Use only to heat food until just warm. Most glass jars are not heat resistant and may break.
Glassware	Heat-resistant oven glassware only. Make sure there is no metallic trim. Do not use cracked or chipped dishes.
Oven cooking bags	Follow manufacturer's instructions. Do not close with metal tie. Make slits to allow steam to escape.
Paper plates and cups	Use for short-term cooking/warming only. Do not leave oven unattended while cooking.
Paper towels	Use to cover food for reheating and absorbing fat. Use with supervision for a short-term cooking only.
Parchment paper	Use as a cover to prevent splattering or a wrap for steaming.
Plastic	Microwave-safe only. Follow the manufacturer's instructions. Should be labeled "Microwave Safe". Some plastic containers soften, as the food inside gets hot. "Boiling bags" and tightly closed plastic bags should be slit, pierced or vented as directed by package.
Plastic wrap	Microwave-safe only. Use to cover food during cooking to retain moisture. Do not allow plastic wrap to touch food.
Thermometers	Microwave-safe only (meat and candy thermometers).
Wax paper	Use as a cover to prevent splattering and retain moisture.

Materials to be avoided in microwave oven

Utensils	Remarks
Aluminum tray	May cause arcing. Transfer food into microwave-safe dish.
Food carton with metal handle	May cause arcing. Transfer food into microwave-safe dish.
Metal or metal-trimmed utensils	Metal shields the food from microwave energy. Metal trim may cause arcing.
Metal twist ties	May cause arcing and could cause a fire in the oven.
Paper bags	May cause a fire in the oven.
Plastic foam	Plastic foam may melt or contaminate the liquid inside when exposed to high temperature.
Wood	Wood will dry out when used in the microwave oven and may split or crack.

SETTING UP YOUR OVEN

Names of Oven Parts and Accessories

Remove the oven and all materials from the carton and oven cavity
Your oven comes with the following accessories:

Instruction Manual 1

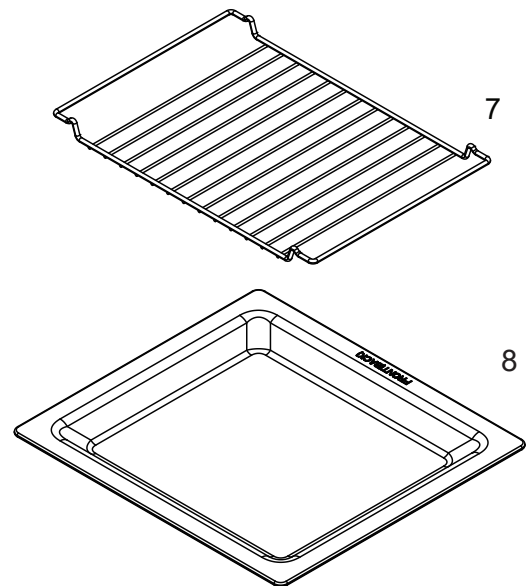
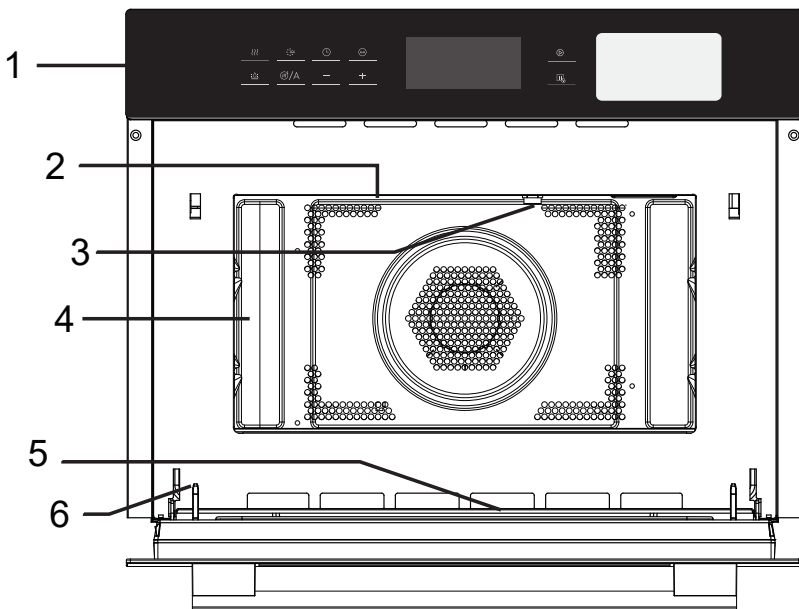

- 1. Control panel
- 2. Grill element
- 3. Light
- 4. Level
- 5. Door glass
- 6. Hinge

- 7. Grill Rack
- 8. Glass Pan

IMPORTANT INFORMATION ABOUT INSTALLING

- This appliance is NOT intended for use in a commercial environment.
- Please observe the installation instructions provided and note that this appliance should only be installed by a qualified technician.
- The appliance is fitted with a plug and must only be connected to a properly installed earthed socket.
- In case a new socket is needed, installation and cable connection must only be done by a qualified electrician. If the plug is no longer accessible following installation, a pole disconnecting device must be present on the installation site with a contact gap of at least 3 mm.
- Adapters, multi-way strips and extension cords must not be used. Overloading can result in fire.
- If the appliance is not fitted with a supply cord and a plug, the connection equipment must have a contact separation in all poles that provide full disconnection, and the appliance must be incorporated in the fixed wiring in accordance with the wiring rules.

The accessible surface
may be hot during
operation.



Fitted units

- This appliance is only intended to be fully fitted in a kitchen.
- This appliance is not designed to be used as a tabletop appliance or inside a cupboard.
- The fitted cabinet must not have a back wall behind the appliance.
- A gap of at least 45 mm must be maintained between the wall and the base or back panel of the unit above.
- The fitted cabinet must have a ventilation opening of 250 cm² on the front. To achieve this, cut back the base panel or fit a ventilation grille.
- Ventilation slots and intakes must not be covered.
- The safe operation of this appliance can only be guaranteed if it has been installed in accordance with these installation instructions.
- The fitter is liable for any damage resulting from incorrect installation.
- The units into which the appliance is fitted must be heat-resistant up to 90 °C .

Installation dimensions

Ventilation openings

behind, min. 250 cm²

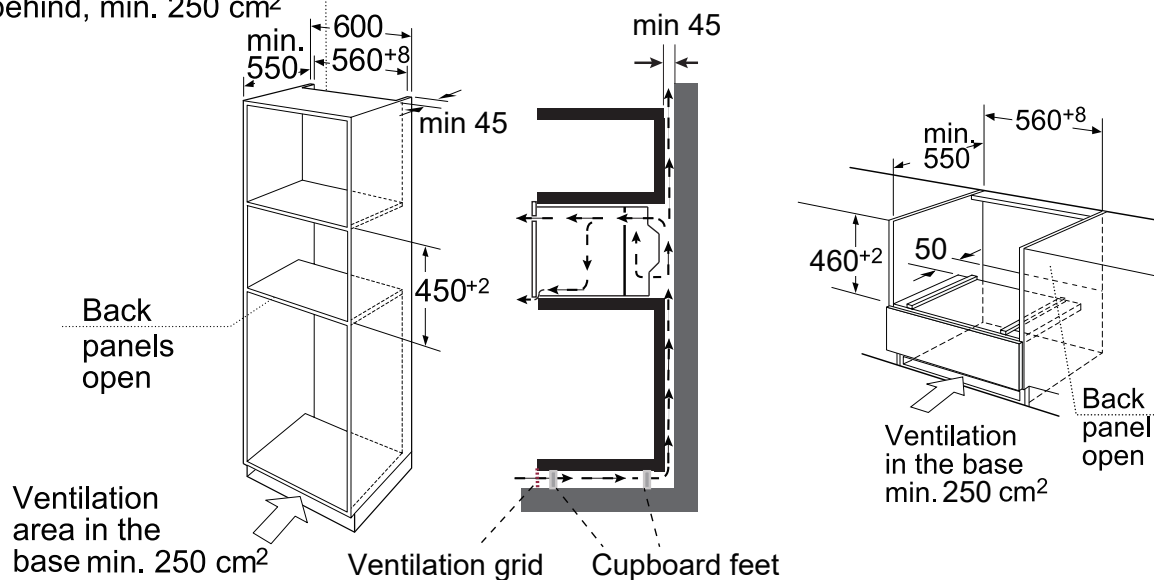

Note: There should be gap above the oven.

Building in

- Do not hold or carry the appliance by the door handle. The door handle cannot hold the weight of the appliance and may break off.
1. Carefully push the oven into the box, making sure that it is in the centre.
 2. Open the door and fasten the oven with the screws that were supplied.

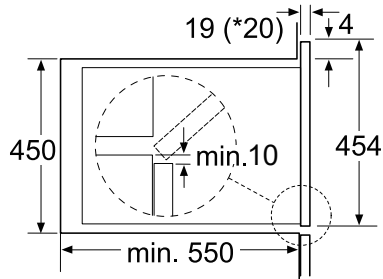
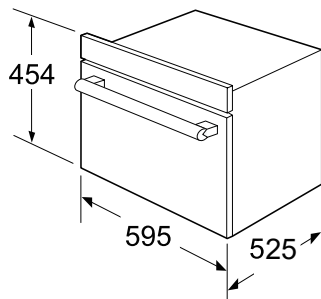

* 20 mm for metal fascias

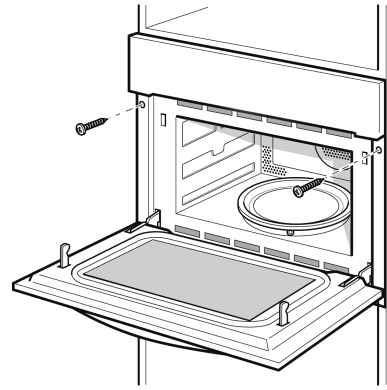

- Fully insert the appliance and centre it.
- Do not kink the connecting cable.
- Screw the appliance into place.
- The gap between the worktop and the appliance must not be closed by additional battens.

Important information

The appliance is designed to be permanently installed with a three-pin power cord and may only be connected by a licensed expert in accordance with the connection diagram.

Only a qualified electrician who takes the relevant regulations into account may replace the power cord.

Do not use multiple plugs, power strips or extensions. Overloading causes a risk of fire.

If the connection is no longer accessible following installation, an all-pin isolating switch with a contact gap of at least 3 mm must be provided.

Connect the wires of the mains power cord in accordance with the following colour coding:

Green and yellow Earth wire < (E)

Blue Neutral wire (N)

Brown Live (L)

Great Britain and Australia:

Do not connect the appliance using a 13 A plug or protect it with a 13 A fuse. The appliance must be protected using a fuse that is rated 16 A or higher. The appliance must be disconnected from the power supply during all installation work. When the appliance is installed, protection must be provided against accidental contact in the future.

BEFORE FIRST USE

Initial cleaning and heating

Removing the microwave oven all of the protection foil on the front.

For more information see the "CLEANING". Before the first use of the appliance,

Remove all accessories and wash out of the microwave.

Electric heating empty containers. New appliances typically smell when first used.

Before using the electrical appliance to cook food faster to heat it helps to banish odors.

- Before heating, it is best to wipe the microwave oven interior with a damp cloth. In this way, storage and untwisting appliances accumulated in the packaging process in furnace dust or residual packing material can be removed.

- Touch "  " keys. Appliance turn on, the main menu appears in the display.

- Touch "  " to choose the convection function.

Recommended temperature will be highlighted, along with microwave started directly.

- Raise the temperature to maximum temperature. This can be achieved by using adjustment keys to achieve.

- Touch "  " symbol next to the sensor keys. Heat the empty oven for at least an hour.

When you do this, make sure that the room well ventilated. Close the door to the other room to avoid odor pervaded the house.

- Let the appliance cool down to room temperature. Then solution of neutral detergent mixed with hot water to clean inside the microwave oven, then wipe dry with a clean soft cloth.

Keep the door open until completely dry in the oven.

OPERATION INSTRUCTION

Control Panel



This microwave oven uses modern electronic control to adjust cooking parameters to meet your needs better for cooking.

1. Clock Setting

When the microwave oven is electrified, "00:00" will blink, buzzer will ring once.

1) Press " — " or " + " to set the right time (between 00:00 and 23:59.)

2) After you have set the right time, press " ⌚ ". The clock has been set.

Note: 1) If you want to change the time, you have to press and hold the " ⌚ " button for 3 seconds. The actual time disappears and then the time will blink in the display.

Press " — " or " + " to set the new time and press the " ⌚ " button to confirm the setting.

2) When you set the clock, long press " — " or " + " to adjust the time by 10min interval and short press for 1 min interval.

NOTE: When press " ⋮⋮⋮ ", you could choose Microwave, Grill, Convection, Grill+Fan, MW+Convection, MW+Grill function, Microwave+Grill+Fan.

2. Microwave Cooking

1) Press the " ⋮⋮⋮ " button to activate the microwave function. "01:00" displays and the microwave icon appears.

2) Press " ⋮⋮⋮ " or " — " or " + " to select cooking mode.

3) Press " ⬅️ ", then press " — " or " + " to adjust the microwave power (900W, 700W, 450W, 300W, 100W). The default power is 900W.

4) Press " ⌚ ", then press " — " or " + " to set the cooking time.

The max. cooking time depends on the power that has been set. When the power is 900W, the MAX. time is 30 minutes and other powers are 90 minutes.

5) Press " ▶️ " button to start cooking.





Microwave Power Chart

Microwave Power	100%	80%	50%	30%	20%
Display	900W	700W	450W	300W	100W





You can see from the table below from which power levels you can choose and for which foods the power levels are suitable.

Power level	Food
900 W	- Boiling water, reheating - Cooking chicken, fish, vegetables
700 W	- Reheating - Cooking mushrooms, shell fish - Cooking dishes containing eggs and cheese
450 W	- Cooking rice, soup
300 W	- Defrosting - Melting chocolate and butter
100 W	- Defrosting sensitive/delicate foods - Defrosting irregularly-shaped foods - Softening ice cream - Allowing dough to rise





3. Grill Cooking

- 1) Press the "  " button to activate the microwave function. "01:00" displays and the microwave icon appears.
- 2) Press "  " or " - " or " + " to select grill mode. The default grill power is the third level.
- 3) Press "  " to choose the grill level.
- 4) Press " - " or " + " to select the level "1-3".
- 5) Press "  " to select the time setting mode. The default time is 10 minutes.
Press " - " or " + " to select the cooking time of grill. The MAX.time is 90 minutes.
- 6) Press "  " button to start cooking.







4. Convection Cooking

- 1) Press the "  " button to activate the microwave function. "01:00" displays and the microwave icon appears.
- 2) Press "  " or " - " or " + " to select convection mode.
The default temperature is 180 degrees.
- 3) Press "  " to enter to the temperature mode.
- 4) Press " - " or " + " to select temperature. The temperature is from 50 to 230 degrees.
- 5) Press "  " to select the time setting mode. The default time is 10 minutes.
Press " - " or " + " to select the cooking time. The MAX.time is 5 hours.
- 6) Press "  " button to start cooking.





5. Grill Fan Cooking



- 1) Press the "  " button to activate the microwave function. "01:00" displays and the microwave icon appears.
- 2) Press "  " or " - " or " + " to select grill fan mode. The default temperature is 180 degrees.
- 3) Press "  " to enter to the temperature selection.
- 4) Press " - " or " + " to select the temperature . The temperature is from 35 to 180 degrees.(35,100,105,110,115,120,125,130,135,140,145,150,155,160,165,170,175,180)
- 5) Press "  " to select the time setting mode. The default time is 10 minutes.
Press " - " or " + " to select the cooking time. The MAX.time is 5 hours.
- 6) Press "  " button to start cooking.

6. Microwave + Grill Cooking







- 1) Press the "  " button to activate the microwave function. "01:00" displays and the microwave icon appears.
- 2) Press "  " or " — " or " + " to select the " MW+GRILL " combination mode.
- 3) Press "  " to enter to the grill level selection.
- 4) Press " — " or " + " to select the level "1-3".
- 5) Press "  " to enter to the microwave power level selection.
- 6) Press " — " or " + " to select the microwave power(700W, 450W, 300W, 100W). The default power is 300W.
- 7) Press "  " to select the time setting mode. The default time is 10 minutes.
- 8) Press " — " or " + " to select the cooking time . The MAX.time is 90 minutes.
- 9) Press "  " button to start cooking.

7. Microwave + Convection Cooking



- 1) Press the "  " button to activate the microwave function. "01:00" displays and the microwave icon appears.
- 2) Press "  " or " — " or " + " to select the "MW+ CONV." combination mode.
- 3) Press "  " to enter to the temperature selection.
The default temperature is 180 degrees.
- 4) Press " — " or " + " to select the temperature between 50 to 230 degrees.
(50,100,105,110,115,120,125,130,135,140,145,150,155,160,
165,170,175,180,185,190,195,200,205,210,215,220,225,230)
- 5) Press "  " to enter to the microwave power level selection.
- 6) Press " — " or " + " to select the microwave power(700W, 450W, 300W, 100W). The default power is 300W.



- 7) Press "  " to select the time setting mode. The default time is 10 minutes.
- 8) Press " — " or " + " to select the cooking time . The MAX.time is 90 minutes.
- 9) Press "  " button to start cooking.

8. Microwave + Grill Fan Cooking

- 1) Press the "  " button to activate the microwave function. "01:00" displays and the microwave icon appears.
- 2) Press "  " or " — " or " + " to select the "MW+GRILL+FAN" combination mode.
- 3) Press "  " to enter to the temperature selection.
The default temperature is 180 degrees.
- 4) Press " — " or " + " to select the temperature. The temperature is from 100 to 180 degrees.
- 5) Press "  " to enter to the microwave power level selection.
- 6) Press " — " or " + " to select the microwave power(700W, 450W, 300W, 100W).
The default power is 300W.
- 7) Press "  " to select the time setting mode. The default time is 10 minutes.
- 8) Press " — " or " + " to select the cooking time . The MAX.time is 90 minutes.
- 9) Press "  " button to start cooking.

9. Auto Cook



- 1) In standby mode, press "  /A " button once, the display " *Δ " lights up to enter defrost menu mode. Press the key more than once, you can switch between the different cooking types such as d01, P01, S01. At this point you can press the " — " or " + " to choose defrost, non steam menu, steam menu switches between three types of cooking.
When the display " A " lights, the appliance enters menu mode automatically. The default symbol weight, cooking time and cooking weight light. The display shows P01 or S01.
- 2) Press the "  " and flashing display shows P01 or S01. At this point, you can press " — " or " + " to select the menu type (P01-P40 or S01-S40).

- 3) Press " " to confirm menu selection and enter the automatic menu weight selection state. Press " — " or " + " to select automatic menu weight and cooking time will display.
- 4) Press " " button to start cooking.

NOTE:



- 1) After steam auto menu, the water pump will withdraw the water back to water tank. There will be some noise sound.
- 2) After steam auto menu, you need to clean the water on cavity and door panel.
- 3) If the menu need preheating, don't put the food in the oven during preheating. Only when the temperature is reached, can you put in the food to start cooking.

10. Defrost

- 1) In standby mode, press " / A " button once to select defrost mode. The display " *Δ " lights. The display also displays d01, initial weight, cooking time and cooking signs light up.
- 2) Press " ", to confirm the selected defrost mode and enter the defrost weight selection state. Press " — " or " + " to select automatic defrost weight. The corresponding cooking time also displays.
- 3) Press " " button to start cooking.

11. Preheating Function

The preheating function can be activated after you have set the functions: Convection, Grill fan, MW-convection, MW-Grill fan.

- 1) Press " / A " button. Then the preheat icon appears in the display.
- 2) Press " " button to start preheating. When the right temperature is reached, you will hear three beeps. You can stop the preheating by opening the oven door or by pressing the " " button.

Note: The preheating function only works if you have already chosen one of the modes above. During preheating, the microwave function is switched off. During preheating, don't put the food in the oven. Only when the temperature is reached, can you put in the food to start cooking.





12. Steam Function

- 1) In standby mode, press " } } } " button to enter the steam mode and time lights up by default 10:00. Press the key several times, switching between different steam modes. You can also press " - " or " + " to do it.
- 2) When you select Steam mode, the icon is displayed, signs light up, there is no Parallax display "10:00", "Min" and "°C" symbol lit, tank icon on the right show the current water level (Water, lack of water). The default temperature 100 lights up.
- 3) Press the " ⬅️➡️ " key to switch to the temperature Cselection, the temperature flashes, at this point, press " - " or " + " to select a temperature (50,60,70,80,90,100).
- 4) Press " ⌚ " to select the time setting mode. The default time is 10 minutes.
- 5) Press " - " or " + " to select the cooking time . The MAX.time is 90 minutes.
- 6) Press " ▶️ " button to start cooking.

13. Convection+Steam Function

- 1) In standby mode, press " } } } " button to enter the steam mode. Time lights up by default 10:00. Press " } } } " or " - " or " + " repeatedly to select Conv. + Steam mode. The icon will display and the default temperature is 180 degrees .
- 2) Press " ⬅️➡️ " to enter to the temperature selection.
- 3) Press " - " or " + " to select temperature.(180,190,200,210,220 degree)
- 4) Press " ⬅️➡️ " button to adjust the steam(10,20,30), and the it flashes on the display, then press " - " or " + " to set steam ratio(default 30 percent).If the steam icon do not flash, you can press the " ⬅️➡️ " key and then press " - " and " + " to set the steam ratio.
- 5) Press " ⌚ " to select the time setting mode. The default time is 10 minutes.
- 6) Press " - " or " + " to select the cooking time. The MAX.time is 90 minutes.
- 7) Press " ▶️ " button to start cooking.



14. Microwave+Steam Function



- 1) In standby mode, press " } } } " button to enter the steam mode. Time lights up by default 10:00. Press " } } } " or " - " or " + " to select the MW+Steam mode. The icon is displayed, then displays 300W.
- 2) Press "  " to enter to the microwave power level selection.
- 3) Press " - " or " + " to select the microwave power(900, 700W, 450W, 300W, 100W). The default power is 300W.
- 4) Press "  " button to adjust the steam ratio, and then it flashes. Then press " - " or " + " to set steam ratio(default 30 percent) . If the steam is not flashed, you can press the "  " key and then press " - " and " + " to set the steam.
- 5) Press "  " to select the time setting mode. The default time is 10 minutes.
- 6) Press " - " or " + " to select the cooking time . The MAX.time depends on the power that has been setted. When the power is 900W, the MAX.time is 30 minutes and other powers are 90 minutes.
- 7) Press "  " button to start cooking.

The ratio of the steam under different microwave power:



Microwave Power	Steam Ratio
100W	10%,20%,30%
300W	10%,20%,30%,40%,50%,60%
450W	10%,20%,30%,40%,50%,60%,70%
700W	10%,20%,30%,40%,50%,60%,70%
900W	10%,20%,30%,40%,50%,60%,70%,80%90%,100%

15. Lock-out Function for Children

Lock: In standby mode, press "  " for 3 seconds, there will be a long "beep" denoting entering into the children-lock state and "  " indicator will light.

Unlock : In locked mode, press "  " for 3 seconds, there will be a long "beep" denoting that the lock is released, and "  " indicator will disappear.

16. Display Specification

- (1) When setting, if there is no other operation, it will confirm automatically after 10 seconds.
Except clock setting for the first time.
- (2) During setting program, after adjusted for 3 seconds, it will confirm automatically.
Except auto menu, it will confirm after adjusted for 10 seconds.
- (3) When the oven is in setting state or pause state, including auto menu and defrost program,
if no operation in 5 minutes, it will enter into the off state.
- (4) The oven lamp will light all the time if the door is open.
- (5) The oven lamp will light all the time if the oven is paused.
- (6) "  " button must be pressed to continue cooking if the oven door is open during cooking process.
- (7) The "  " button can be press in any state to open the water tank.

Add water to here

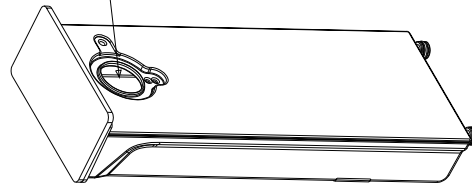

Steam note:

1. Before steam cooking:

Before starting the steam cooking mode, if the tank is short of water, press  button, abnormal buzzer will ring and the screen icon will show water scarcity status of water level to remind you to add water.

Note: Before starting the steam cooking mode, please clean the water tank.

2. During steam cooking:

During steam cooking mode, if the tank is short of water, abnormal buzzer will ring and the screen icon will show water scarcity status of water level to remind you to add water. After adding water, it can work normally.

3. After steam cooking:

1-After steam function is finished, the water in boiler will be withdraw to water tank. This process lasts about 1 minute.

2-During the process to withdraw the water back to water tank, if the water tank is full, the system will be beeping 10 times to remind you to clean up the tank. After the water tank is empty, the system will continue to withdraw water.

Note: After steam cooking, please remove the water from water tank.

Defect codes

Below defect codes may occur during steam functions :





E-06: 1-Water tank is not close well.

E-05: water system abnormal, need to contact for Engineer to check, below is the possibilities.

- 1-The water sensor is abnormal.
- 2-The water pipe is abnormal.
- 3-The water pump is abnormal.
- 4-The water tank is abnormal.

17. Auto Scale Removal Function

For best cleaning results, we recommend that you use detergent sodium citrate, which were randomly for descaling steam microwave oven. Follow the manufacturer's instructions on the packaging. It is suggested that descaling function should be used after the steam function has been run for 20 hours.

- 1) Power up the system and remove the water tank. Then inject 1000ml of fresh water into the water tank and add a pack of descaling agent.
- 2) Push the tank into the furnace where appropriate.
- 3) In standby mode, press "  /A "button. The display "  " lights and screen displays default mode d01, default weight 0.10, corresponding cooking time and " Kg ""Min" light up.
- 4) Press "  /A " repeatedly, when " CLE " indicator lighten, it means to enter Scale Removal function. "Min" and default time " 20:00 " lights up, tank icon shows the current water level (water, lack of water, full of water), other icons disappear.
- 5) Press "  " to start the program.
- 6) Wait for 1 minute after the program has finished. Take out the water tank and pour the water in the tank. Thoroughly clean the water tank.
- 7) Replace the fresh water and then repeat steps 3 to 6.

Note: the descaling process shall not be shut down. If the descaling process shut down before the end, the entire program must be started from step 3.

STEAM MENU

AUTO-MENU	DISPLAY	WEIGHT	POWER
Trout	S01	200	Steam100°C +300W
		300	
		400	
		500	
		600	
Salmon Filet	S02	200	Steam100°C +100W
		300	
		400	
		500	
		600	
Pikeperch	S03	200	Steam100°C +300W
		300	
		400	
		500	
		600	
Prawns	S04	200	Steam100°C
		300	
		400	
		500	
		600	
Halibut filet	S05	200	Steam100°C +300W
		300	
		400	
		500	
		600	
Cockles	S06	200	Steam100°C +100W
		300	
		400	
		500	
		600	
Cod filet	S07	200	Steam100°C +300W
		300	
		400	
		500	
		600	
Herring	S08	200	Steam100°C +300W
		300	
		400	
		500	
		600	
Tuna filet	S09	200	Steam100°C +100W
		300	
		400	
		500	
		600	

Crab	S10	2	Steam100°C +300W
		3	
		4	
		5	
		6	
Chicken leg	S11	200	Steam100°C+300W
		300	
		400	
		500	
		600	
Chicken breast	S12	200	Steam100°C +300W
		300	
		400	
		500	
		600	
		700	
		800	
Meatball	S13	200	Steam100°C +300W
		300	
		400	
		500	
		600	
Turkey escalope	S14	400	Steam100°C +300W
		500	
		600	
		700	
		800	
Pork filet, whole	S15	200	Steam100°C +300W
		300	
		400	
		500	
		600	
Sausages	S16	200	Steam100°C +100W
		300	
		400	
		500	
		600	
Eggs in Glass	S17	1	Steam100°C
		3	
Eggs, hard	S18	1	Steam100°C
		3	
Eggs, soft	S19	1	Steam100°C
		3	
Brown rice + water	S20	200g+400mL	Steam100°C+450W/ Steam100°C+300W
		400g+800mL	
Rice + water	S21	200g+300mL	Steam100°C+450W/ Steam100°C+300W
		400g+600mL	

Eggplant/ Aubergine	S22	200	Steam100°C +300W
		300	
		400	
		500	
		600	
Beans	S23	200	Steam100°C +300W
		300	
		400	
		500	
		600	
Broccoli	S24	200	Steam100°C
		300	
		400	
		500	
		600	
Cauliflower	S25	200	Steam100°C +300W
		300	
		400	
		500	
		600	
Peas	S26	200	Steam100°C +300W
		300	
		400	
		500	
		600	
Potatoes with skin (whole, small)	S27	1	Steam100°C +300W
		2	
		3	
		4	
Potatoes with skin (whole, big)	S28	1	Steam100°C +300W
		2	
		3	
		4	
Potatoes without skin (pieces)	S29	200	Steam100°C +300W
		300	
		400	
		500	
		600	
Carrots	S30	200	Steam100°C +300W
		300	
		400	
		500	
		600	
Corn cobs	S31	2	Steam100°C +300W
		3	
		4	
		5	
		6	

Bell peppers	S32	200	Steam100°C
		300	
		400	
		500	
		600	
Hot peppers	S33	200	Steam100°C
		300	
		400	
		500	
		600	
Mushrooms	S34	200	Steam100°C +300W
		300	
		400	
		500	
		600	
Leeks	S35	200	Steam100°C +300W
		300	
		400	
		500	
		600	
Brussels sprouts	S36	200	Steam100°C
		300	
		400	
		500	
		600	
Celery	S37	200	Steam100°C +300W
		300	
		400	
		500	
		600	
		700	
		800	
Asparagus	S38	200	Steam100°C +100W
		300	
		400	
		500	
		600	
Spinach	S39	200	Steam100°C +300W
		300	
		400	
		500	
		600	
Courgette	S40	200	Steam100°C +300W
		300	
		400	
		500	
		600	

NO-STEAM MENU

AUTO-MENU	DISP LAY	WEIGHT	POWER
Melt chocolate	P01	100	450W
		150	450W
		200	450W
Melt butter	P02	100	450W
		150	450W
		200	450W
Sweet potato	P03	200	100W+220°C
		400	100W+220°C
		600	100W+220°C
Chicken Whole	P04	800	100W+220°C
		1000	100W+220°C
		1200	100W+220°C
Chicken Leg	P05	200	450W+220°C
		300	450W+220°C
		400	450W+220°C
		500	450W+220°C
		600	450W+220°C
		700	450W+220°C
		800	450W+220°C
Chicken Wings	P06	200	300W+220°C
		300	300W+220°C
		400	300W+220°C
		500	300W+220°C
		600	300W+220°C
		700	300W+220°C
		800	300W+220°C
Fish Whole	P07	1	100W+220°C
		2	100W+220°C
		3	100W+220°C
Fish Steak	P08	200	100W+220°C
		300	100W+220°C
		400	100W+220°C
		500	100W+220°C
		600	100W+220°C
Fresh pizza	P09	200	Pre-heat/200°C conv.
		300	Pre-heat/200°C conv.
		400	Pre-heat/200°C conv.
		500	Pre-heat/200°C conv.
		600	Pre-heat/200°C conv.
Frozen Pizza	P10	200	100W+220°C
		300	100W+220°C
		400	100W+220°C
Cake	P11	400	Pre-heat/150°C
		500	Pre-heat/150°C
		600	Pre-heat/150°C

Roast Pork	P12	400	450W+220°C
		500	450W+220°C
		600	450W+220°C
		700	450W+220°C
		800	450W+220°C
		900	450W+220°C
		1000	450W+220°C
Chicken kabobs	P13	200	100W+220°C
		300	100W+220°C
		400	100W+220°C
		500	100W+220°C
		600	100W+220°C
Shrimp	P14	200	Pre-heat/220°C
		400	Pre-heat/220°C
		600	Pre-heat/220°C
Beef steak	P15	400	100W+220°C
		500	100W+220°C
		600	100W+220°C
		700	100W+220°C
		800	100W+220°C
		900	100W+220°C
		1000	100W+220°C
Barbecued Spareribs	P16	200	100W+220°C
		400	100W+220°C
		600	100W+220°C
Chocolate cookies	P17	500	Pre-heat/180°C
Lemon cookies	P18	400	Pre-heat/200°C
Sausage	P19	200	Pre-heat/220°C
		400	Pre-heat/220°C
		600	Pre-heat/220°C
Finger food	P20	200	Pre-heat/220°C
		300	Pre-heat/220°C
		400	Pre-heat/220°C
Reheat	P21	200	900W
		300	900W
		400	900W
		500	900W
		600	900W
Potato	P22	1	900W
		2	900W
		3	900W
Beverage	P23	1	900W
		2	900W
		3	900W

Pasta	P24	100 (+800ml cold water)	700W
		150 (+1000ml cold water)	
		200 (+1200ml cold water)	
Soup	P25	1	900W
		2	
		3	
Pizza	P26	1	900W
		2	
		3	
Muffin	P27	1	900W
		2	
		3	
		4	
Oatmeal	P28	50+500ml water	900W/450W
		100+1000ml water	
		150+1500ml water	
Baked Apple	P29	2	700W
		3	
		4	
Sandwich	P30	1	900W
		2	
		3	
Popcorn	P31	50	900W
		100	
Fudge Brownies	P32	800	100W+180°C
Bread	P33	100	Grill Level3
		150	
		200	
Chick nuggets	P34	200	100W+220°C
		300	
		400	
		500	
		600	
Fresh Fines	P35	200	100W+220°C
		300	
		400	
		500	
Oatmeal raisin cookies	P36	600	Pre-heat/180°C
Pecan crisps	P37	500	Pre-heat/180°C

Peanut chocolate cookies	P38	500	Pre-heat/180°C
Hamburg	P39	2	100W+220°C
		4	
		6	
Muffin	P40	840 (70g*12)	Pre-heat/180°C

TROUBLE SHOOTING

Normal	
Microwave oven interfering TV reception	Radio and TV reception may be interfered when microwave oven operating. It is similar to the interference of small electrical appliances, like mixer, vacuum cleaner, and electric fan. It is normal.
Dim oven light	In low power microwave cooking, oven light may become dim. It is normal.
Steam accumulating on door, hot air out of vents	In cooking, steam may come out of food. Most will get out from vents. But some may accumulate on cool place like oven door. It is normal.
Oven started accidentally with no food in.	It is forbidden to run the unit without any food inside. It is very dangerous.

Trouble	Possible Cause	Remedy
Oven cannot be started.	(1) Power cord is not plugged in tightly.	Unplug. Then plug again after 10 seconds.
	(2) Fuse blowing or circuit breaker works.	Replace fuse or reset circuit breaker (repaired by professional personnel of our company)
	(3) Trouble with outlet.	Test outlet with other electrical appliances.
Oven does not heat.	(4) Door is not closed well.	Close door well.



According to Waste of Electrical and Electronic Equipment (WEEE) directive, WEEE should be separately collected and treated. If at any time in future you need to dispose of this product please do NOT dispose of this product with household waste. Please send this product to WEEE collecting points where available.

