



Washing Machine

OWNER'S MANUAL

MFN75-S1403/C31E-AU(25)

Read This Manual

Use all instructions and explanations of the installation before use. Follow the instructions carefully. Keep the operation instructions handy for later use. If the application is sold or passed on then ensure that the new owner always receives those operation instructions.

CONTENTS

SAFETY INSTRUCTIONS

■ Safety Instructions	2
-----------------------------	---

INSTALLATION

■ Product Description	7
■ Installation	8

OPERATIONS

■ Quick Start	11
■ Before Each Washing	12
■ Detergent Dispenser	13
■ Control Panel	14
■ Option.....	15
■ Other Functions	16
■ Programmes	18

MAINTENANCES

■ Cleaning And Care	20
■ Trouble Shooting	23
■ Technical Specifications	24
■ Testing methods	25

SAFETY INSTRUCTIONS

■ Safety Instructions

For your safety, the information in this manual must be followed to minimize the risk of fire or explosion, electric shock, or to prevent property damage, personal injury or loss of life.

Explanation of the symbols:

Warning!

This combination of symbol and signal word indicates a potentially dangerous situation which may result in death or serious injuries unless it's avoided.

Caution!

This combination of symbol and signal word indicates a potentially dangerous situation which may result in slight or minor injuries or damage to property and the environment.

Note!

This combination of symbol and signal word indicates a potentially dangerous situation which may result in slight or minor injuries.

Warning!

The electric shock!

- If the supply cord is damaged, it must be replaced by the manufacturer, its service agent or similarly qualified persons in order to avoid a hazard.

SAFETY INSTRUCTIONS

- The new hose-sets supplied with the appliance are to be used and that old hose-sets should not be reused.
- Before any maintenance the device, unplug the appliance from the mains.
- Always unplug the machine and turn off the water supply after use. The max. inlet water pressure, in pascals. The min. inlet water pressure, in pascals.
- To ensure your safety, power plug must be inserted into an earthed three-pole socket. Check carefully and make sure that your socket is properly and reliably earthed.
- Make sure that the water and electrical devices must be connected by a qualified technician in accordance with the manufacturer's instructions and local safety regulations.

Risk to children!

- EN countries: the appliance can be used by children aged from 8 years and above and persons with reduced physical, sensory or mental capabilities or lack of experience and knowledge if they have been given supervision or instruction concerning use of the appliance in a safe way and understand the hazards involved. Children shall not play with the appliance. Cleaning and user maintenance shall not be made by children without supervision.
- Children of less than 3 years should be supervised to ensure that they do not play with appliance.
- Animals and children may climb into the machine. Check the machine before every operation.
- Kids should be supervised that they do not play with the appliance.

SAFETY INSTRUCTIONS

- Glass door may be very hot during the operation. Keep kids and pets far away from the machine during the operation very wet rooms as well as in the rooms with explosive or caustic gas.
- Remove all packages and transport bolts before using the appliance. Otherwise, serious damage may result.
- Plug must be accessible after installation.

Risk of explosion!

- Do not wash or dry articles that have been cleaned in, washed in, soaked in, or dabbed with combustible or explosive substances(such as wax, oil, paint, gasoline, degreasers, dry-cleaning solvents, kerosene, etc.) This may result in fire or explosion.
- Before hand thoroughly rinse items of washing by hand.

⚠ Caution!

Installing the product!

- This washing machine is for indoor use only.
- It isn't intended to be built-in using.
- The openings must not be obstructed by a carpet.
- Washing machine shall not be installed in bath room or very wet rooms as well as in the rooms with explosive or caustic gases.
- The washing machine with single inlet valve only can be connected to the cold water supply. The product with double inlet valves should be correctly connected to the hot water and cold water supply.
- Plug must be accessible after installation.

SAFETY INSTRUCTIONS

- Remove all packages and transport bolts before using the appliance. Otherwise, serious damage may result.

Risk of damaging appliance!

- Your product is only for home use and is only designed for the textiles suitable for machine washing.
- Do not climb up and sit on top cover of the machine.
- Do not lean against machine door.
- Cautions during Handling Machine:
 - 1.Transport bolts shall be reinstalled to the machine by a specialized person.
 - 2.The accumulated water shall be drained out of the machine.
 - 3.Handle the machine carefully. Never hold each protruded part on the machine while lifting. Machine door can not be used as the handle during the conveyance.
 - 4.This appliance is heavy. Transport with care.
- Please do not close the door with excessive forces. If it is found difficult to close the door, please check if the clothes are put in or distributed well.
- It is forbidden to wash carpets.

Operating the appliance!

- Before washing the clothes at first time, the product shall be operated in one round of the whole procedures without the clothes inside.
- Flammable and explosive or toxic solvents are forbidden. Gasoline and alcohol etc. Shall not be used as detergents. Please only select the detergents suitable for machine washing, especially for drum.

SAFETY INSTRUCTIONS

- Make sure that all pockets are emptied. Sharp and rigid items such as coin, brooch, nail, screw or stone etc. may cause serious damages to this machine.
- Please check whether the water inside the drum has been drained before opening its door. Please do not open the door if there is any water visible.
- Be careful of burning when the product drains hot washing water.
- Never refill the water by hand during washing.
- After the program is completed, Please wait for two minutes to open the door.

Packaging/Old appliance



This marking indicates that this product should not be disposed with other household wastes throughout the EU. To prevent possible harm to the environment or human health from uncontrolled waste disposal, recycle it responsibly to promote the sustainable reuse of material resources. To return your used device, please use the collection systems or contact the retailer where the product was purchased. They return and can take this product for environmental safe recycling.

INSTALLATION

■ Product Description

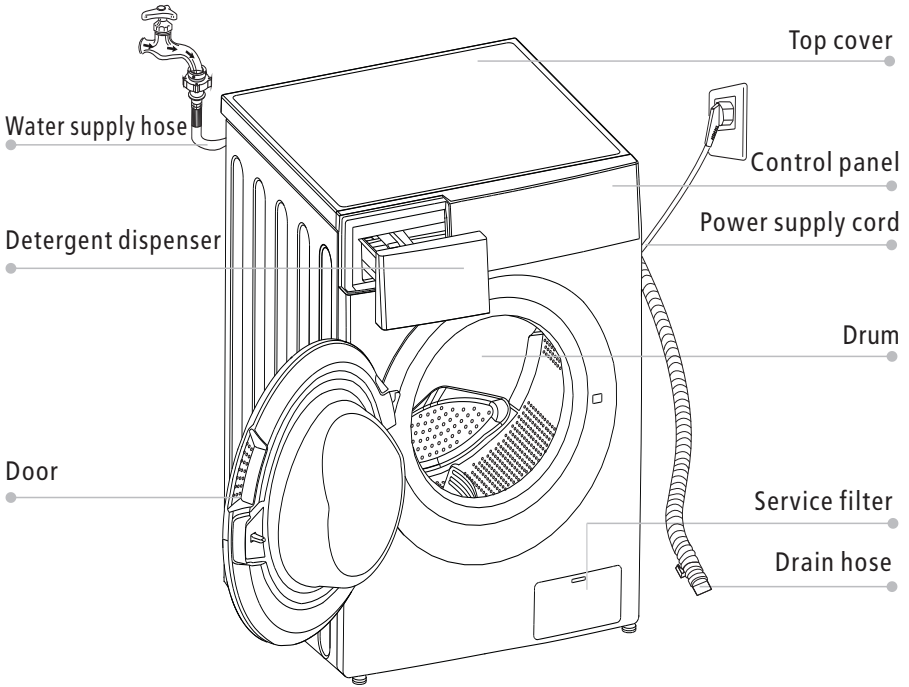

Note!

- The product line chart is for reference only, please refer to real product as standard.

Accessories

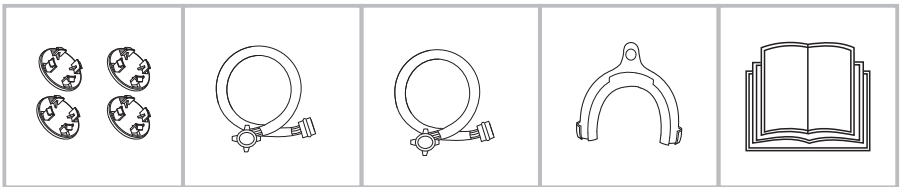

Transport hole plug

Supply hose cold water

Supply hose hot water (optional)

Drain hose support (optional)

Owner's manual

INSTALLATION

■ Installation

Installation area

⚠ Warning!

- Stability is important to prevent the product from wandering!
- Make sure that the product should not stand on the power cord.

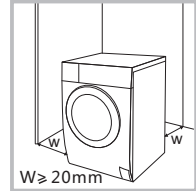

Before installing the machine, the location characterized as follows shall be selected:

1. Rigid, dry, and level surface
2. Avoid direct sunlight
3. Sufficient ventilation
4. Room temperature is above 0°C
5. Keep far away from the heat resources such as coal or gas.

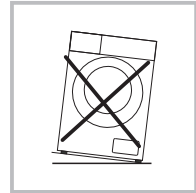

Unpacking the washing machine

⚠ Warning!

- Packaging material (e.g. Films, Styrofoam) can be dangerous for children.
- There is a risk of suffocation ! Keep all packaging well away from children.

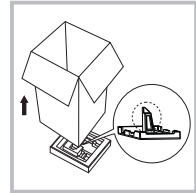

1. Remove the cardboard box and styrofoam packing.
2. Lift the washing machine and remove the base packing. Make sure the small triangle foam is removed with the bottom one together. If not, lay the unit down with side surface, then remove the small foam from the unit bottom manually.
3. Remove the tape securing the power supply cord and drain hose.
4. Remove the inlet hose from the drum.

Remove transport bolts

⚠ Warning!

- You must remove the transport bolts from the backside before using the product.
- You'll need the transport bolts again if you move the product, so make sure you keep them in a safe place.

Please take the following steps to remove the bolts:

1. Loosen 4 bolts with spanner and then remove them.
2. Stop the holes with transport hole plugs.
3. Keep the transport bolts properly for future use.

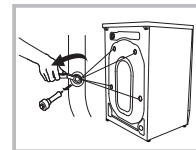

INSTALLATION

Levelling the washing machine

⚠ Warning!

- The lock nuts on all four feet must be screwed tightly against the housing.

1. Check if the legs are closely attached to the cabinet. If not, please turn them to their original positions tighten the nuts.
2. Loosen the lock nut turn the feet until it closely contacts with the floor.
3. Adjust the legs and lock them with a spanner, make sure the machine is steady.

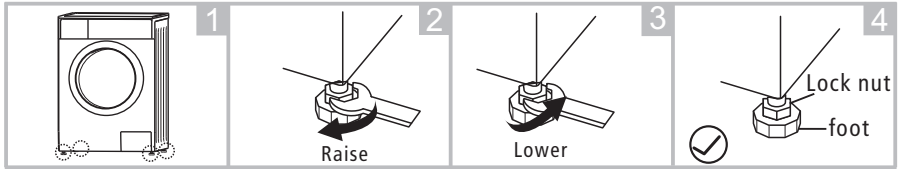

Connect Water Supply Hose

⚠ Warning!

- To prevent leakage or water damage, follow the instructions in this chapter!
- Do not kink, crush, modify or sever water inlet hose.
- For the model equips hot valve, connect it to hot water tap with hot water supply hose. Energy consumption will decrease automatically for some program.

Connect the inlet pipe as indicated, There are two ways to connect the inlet pipe.

1. Connection between ordinary tap and inlet hose.

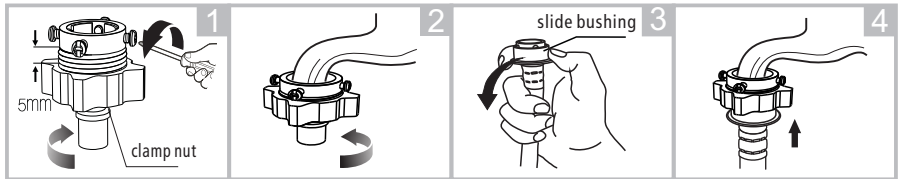

Loosen clamp nut and four bolts

Tighten clamp nut

Press slide bushing, insert inlet hose into connecting base

Connection finished

2. Connection between screw tap and inlet hose.

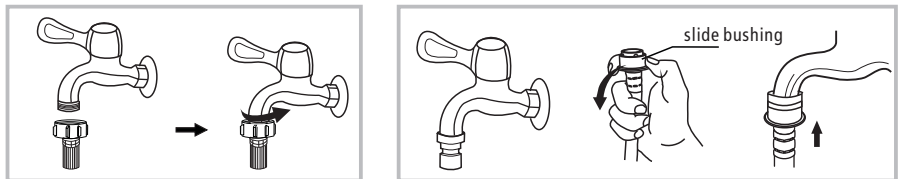

Tap with threads and inlet hose

Special tap for washing machine

INSTALLATION

Connect the other end of inlet pipe to the inlet valve at the backside of product and fasten the pipe tightly clockwise.

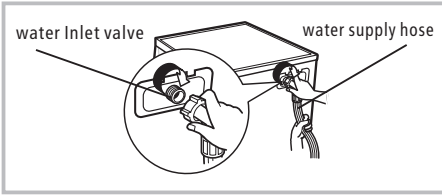

Drain Hose

⚠ Warning!

- Do not kink or protract the drain hose.
- Position drain hose properly ,otherwise damage might result of water leakage.

There are two ways to place the end of drain hose:

1.Put it into the water trough.

2.Connect it to the branch drain pipe of the trough.

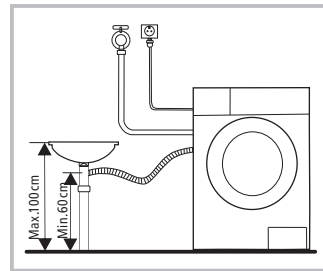
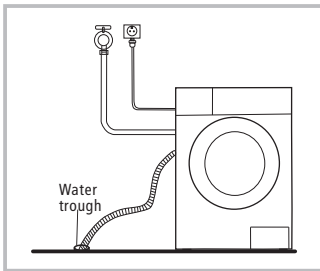

📌 Note!

- If the machine has drain hose support, please install it like the following .

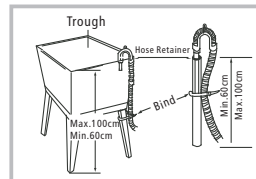
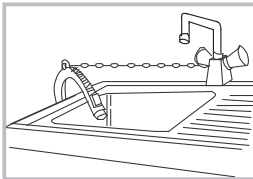

⚠ Warning!

- When installing drain hose, fix it properly with a rope.
- If drain hose is too long, do not force it into washing machine as it will cause abnormal noises.

OPERATIONS

■ Quick Start

⚠ Caution!

- Before washing, please make sure it's installed properly.
- Before washing at first time, the washing machine shall be operated in one round of the whole procedures without clothes in as follows.

1. Before Washing

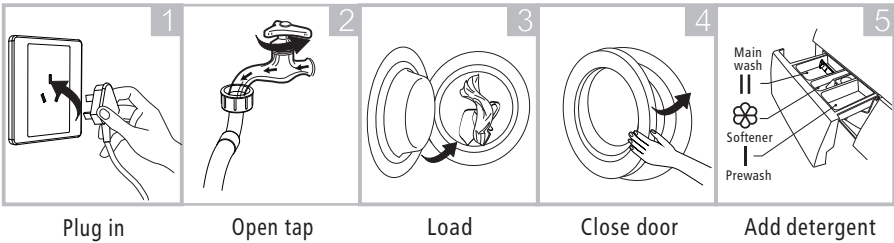

📌 Note!

- Detergent need to be added in "case I" after selecting pre-washing for machines with this function.

2. Washing

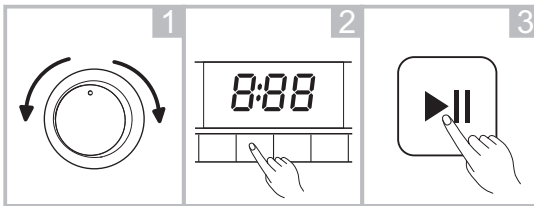

Select Programme Select function or default Start up

📌 Note!

- If default is selected, step 2 can be skipped.

3. After Washing

"End" on display.

OPERATIONS

■ Before Each Washing

- The working condition of the washer should be (0-40)°C. If used under 0°C, the inlet valve and draining system may be damaged. If the machine is placed under condition of 0°C or less, then it should be transferred to normal ambient temperature to ensure the water supply hose and drain hose are not frozen before use.
- Please check the labels and the explanation of using detergent before wash. Use non-foaming or less-foaming detergent suitable for machine washing properly.

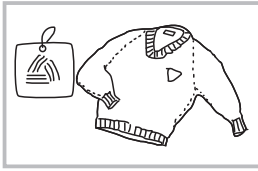

Check the label

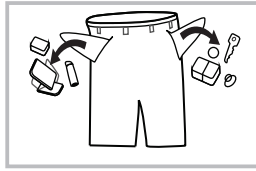

Take out the items out of the pockets

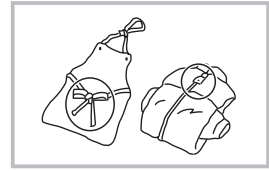

Knot the long strips, zip or button

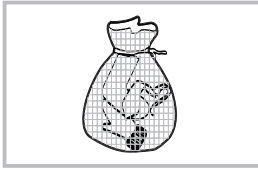

Put small clothes into the pillow slip

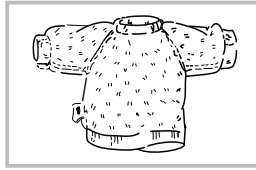

Turn easy-pilling and long-pile fabric inside out

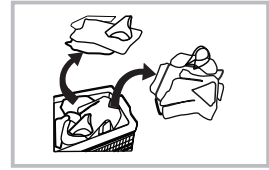

Separate clothes with different textures

⚠ Warning!

- When washing a single clothes, it may easily cause great eccentricity and give alarm due to great unbalance. Therefore it is suggested to add one or two more clothes to be washed together so that draining can be done smoothly.
- Don't washing the clothes touching with kerosene, gasoline, alcohol and other flammable materials.

OPERATIONS

■ Detergent Dispenser

- I Pre wash detergent
- II Main wash detergent
- ☼ Softener

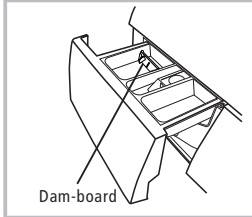

Liquid detergent

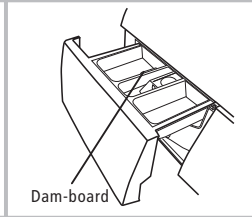

Powder detergent

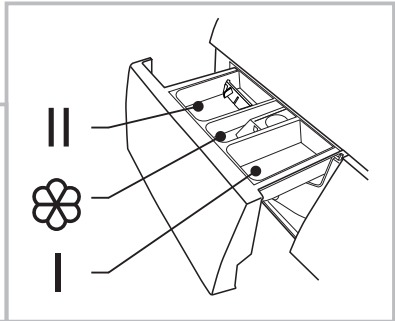

Pull out the dispenser

⚠ Caution!

- Detergent only need to be added in "case I" after selecting pre-washing for machines with this function.

Programme	I	II	☼	Programme	I	II	☼
Cotton Eco		●	○	Bulky/Bedlinen	○	●	○
Cotton	○	●	○	Baby Care	○	●	○
Synthetic	○	●	○	Wool		●	○
Mix	○	●	○	Sport Wear	○	●	○
Delicate		●	○	Daily/Rapid 45'	○	●	○
Jeans	○	●	○	Quick 15'		●	○
Color		●	○	Intensive		●	○
Spin Only				ECO 40-60		●	○
Rinse & Spin			○	20°C		●	○

● Means must ○ Means optional

OPERATIONS

Control Panel

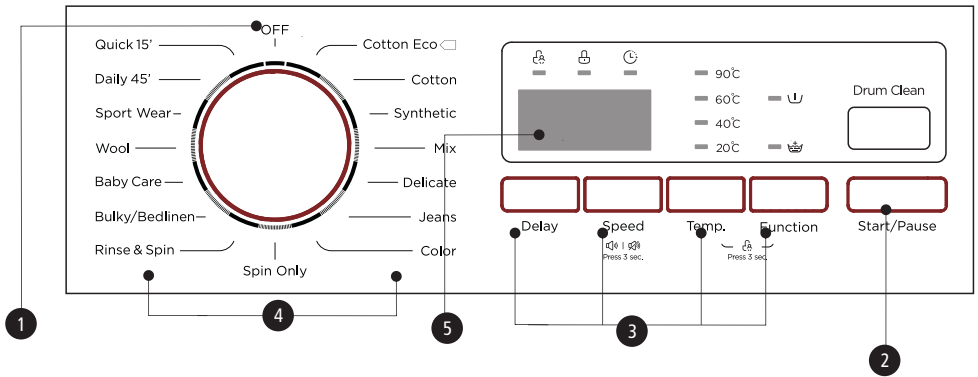

Note!

- The chart is for reference only, Please refer to real product as standard.

1 On/Off

Product is switched On/Off.

2 Start/Pause

Press the button to start or pause the washing cycle.

3 Option

This allows you to select an additional function and will light when selected.

4 Programmes

Available according to the laundry type.

5 Display

The display shows the settings, estimated time remaining, options, and status messages for your washer. The display will remain on through the cycle.

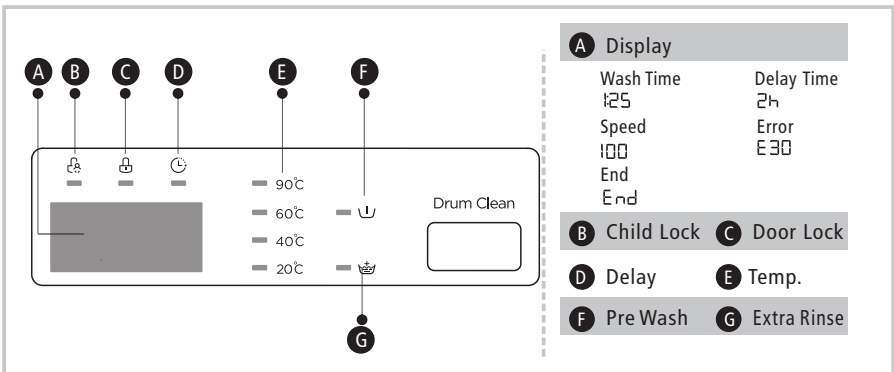

OPERATIONS

■ Option

Delay

Delay

Set the Delay function:

1. Select a programme; 2. Press the Delay button to choose the time (the delaying time is 0-24 H.);
3. Press [Start/Pause] to commence the delay operation



Choose the Programme

Setting time

Start

Cancel the Delay function:

Press the [Delay] button until the display be 0H. It should be pressed before starting the programme. If the programme already started, should switch off programme to reset a new one.

ⓘ Caution!

- If there is any break in the power supply while the machine is operating, a special memory stores the selected programme and when the power is restarted, the program will continue.

Programme	Option			Programme	Option		
	Delay	Extra rinse	Pre wash		Delay	Extra rinse	Pre wash
Cotton Eco	<input type="radio"/>			Bulky/Bedlinen	<input type="radio"/>	<input type="radio"/>	<input type="radio"/>
Cotton	<input type="radio"/>	<input type="radio"/>	<input type="radio"/>	Baby Care	<input type="radio"/>	<input type="radio"/>	<input type="radio"/>
Synthetic	<input type="radio"/>	<input type="radio"/>	<input type="radio"/>	Wool	<input type="radio"/>	<input type="radio"/>	
Mix	<input type="radio"/>	<input type="radio"/>	<input type="radio"/>	Sport Wear	<input type="radio"/>	<input type="radio"/>	<input type="radio"/>
Delicate	<input type="radio"/>	<input type="radio"/>		Daily/Rapid 45'	<input type="radio"/>	<input type="radio"/>	<input type="radio"/>
Jeans	<input type="radio"/>	<input type="radio"/>	<input type="radio"/>	Quick 15'	<input type="radio"/>		
Color	<input type="radio"/>	<input type="radio"/>		Intensive	<input type="radio"/>		
Spin Only	<input type="radio"/>			ECO 40-60	<input type="radio"/>		
Rinse & Spin	<input type="radio"/>	<input type="radio"/>		20°C	<input type="radio"/>	<input type="radio"/>	

- Means optional (Some models have intelligent weighing function, please refer to the actual product)

OPERATIONS

■ Other Functions

Temp.

Temp.

Press the button to regulate the temperature(Cold,20°C, 40°C,60°C,90°C)

Speed

Speed

Press the button to change the speed.

1400: 0-400-600-800-1000-1200-1400

Programme	Default Speed(rpm)	Programme	Default Speed(rpm)
	1400		1400
Cotton Eco	800	Rinse & Spin	800
Cotton	1400	Bulky/Bedlinen	800
Synthetic	1200	Baby Care	800
Mix	800	Wool	600
Delicate	600	Sport Wear	800
Jeans	800	Daily/Rapid 45'	800
Color	800	Quick 15'	800
Spin Only	800		

OPERATIONS



Child Lock

To avoid mis operation by children.



or



Choose the Programme

Start

Press [Temp.] and [Function] or [Temp.] and [Dry]
3 sec. till buzzer beep.

⚠ Caution!

When child lock is activated and program starts, child lock indicator will switch on, and the CL and remaining time on the display are alternately displayed in 0.5s. Press the other buttons will make child lock indicator flash for 3s. when program finish, CL and END alternate for 10s in 0.5s, then the child lock lights flash for 3s.

- only press and hold the two button can release child lock, even power off, switch off and program end
- The "Child Lock" will lock all buttons except Power button and Child Lock button
- please release child lock before selecting program and starting washing.



Mute the buzzer



Choose the Programme

Press the [Speed] button for 3sec.,
the buzzer is mute.

To act the buzzer function, press the button again for 3 seconds. The setting will be kept until the next reset.

⚠ Caution!

- After Muting the buzzer function, the sounds will not be activated any more.

Drum Clean

Drum Clean

After the machine runs to the set counting period(counting cycle is 25 times), Drum Clean lamp flashes at the end of the last program, reminding the user to run the program;

Release condition:

1. Press and hold the Drum Clean button for 3s, Drum cleaner indicator remind will be cancel and the washing cycles will be recount for another 25 cycles.
2. The counted cycles will be recounted when drum clean program is finished.

OPERATIONS

■ Programmes

Programmes are available according to the laundry type.

Programmes	
Cotton	Hard-wearing textiles, heat-resistant textiles made of cotton or linen.
Synthetic	Wash synthetic articles, for example: shirts, coats, blending. While washing the knitting textiles, detergent quantity shall be reduced due to its loose string construction and easily forming bubbles.
Baby Care	Washing the baby's clothes, it can make the baby's wear cleaner and make the rinse performance better to protect the baby skin.
Daily/Rapid 45'	Washing few and not very dirty clothes quickly.
Mix	Mixed load consisting of textiles made of cotton and synthetics.
Jeans	Specially for jeans.
Color/20°C	Washing brightly colored clothes, it can protect the colors better.
Quick 15'	Extra short programme approx, suitable for lightly soiled washing as a small amounts of laundry.
Delicate	For delicate, washable textiles, e.g. made of silk, satin, synthetic fibres or blended fabrics.
Wool	Hand or machine-washable wool or richwool textiles. Especially gentle wash programme to prevent shrinkage, longer programme pauses (textiles rest in wash liquor).
Spin Only	Extra spin with selectable spin speed.
Rinse&Spin	Extra rinse with spin.
Cotton Eco	To increase the washing effects, washing time is increased.
Drum Clean	Specially set in this machine to clean the drum and tube. It applies 90 °C high temperature sterilization to make the clothes washing more green. When this programme is performed, the clothes or other washing cannot be added. When proper amount of chlorine bleaching agent is put in, the barrel cleaning effect will be better. The customer can use this programme regularly according to the need.
Sport Wear	Washing the activewear.
Bulky/Bedlinen	This program is specially designed for washing Bulky/Bedlinen.

OPERATIONS

Programmes

Dry Only Select it to dry clothes, the temperature is different .The drying time according to the load .

1 Hour W/D For small synthetic clothes or shirts, load limitation is 1 kg (about 4 shirts). When you have an urgent appointment but no more clean shirt left in your cupboard, this program will help you. Time duration is only 1 hour including wash and dry. Remark: Big towels or jeans is not suitable for this program, they will enlarge the time duration and affect the moisture content.

5kg W/D For wash and dry, load limitation is 5 kg.

ECO 40-60 Default 40°C, not selectable, suitable for laundry washing at about 40°C-60°C.

Intensive To increase the washing effects, washing time is increased.

Wash & Dry The standard energy program.

Note!

- Reference to your product to select the programmes.

MAINTENANCES

■ Cleaning And Care

Warning!

- Before your maintenance starts, please unplug the machine and close the tap.

Cleaning The Cabinet

Proper maintenance on the washing machine can extend its working life. The surface can be cleaned with diluted non-abrasive neutral detergents when necessary. If there is any water overflow, use the wet cloth to wipe it off immediately. No sharp items are allowed.



Note!

- Formic acid and its diluted solvents or equivalent are forbidden, such as alcohol, solvents or chemical products, etc.

Cleaning The Drum

The rusts left inside the drum by the metal articles shall be removed immediately with chlorine-free detergents. Never use steel wool.

Note!

- Don't put laundry in the washing machine during the drum cleaning.

Cleaning The Door Seal And Glass

Wipe the glass and seal after each wash to remove lint and stains. If lint builds up it can cause leaks. Remove any coins, buttons and other objects from the seal after each wash.

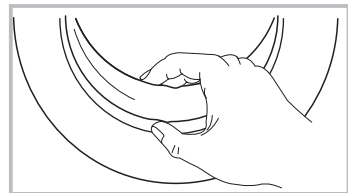

MAINTENANCES

Cleaning The Inlet Filter

Note!

- Inlet filter must be cleaned if there is less water.

Washing the filter in the tap

1. Close the tap.
2. Remove the water supply hose from the tap.
3. Clean the filter.
4. Reconnect the water supply hose.

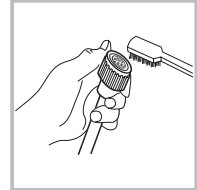
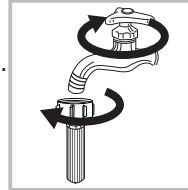

Washing the filter in washing machine:

1. Screw off the inlet pipe from the backside of the machine.
2. Pull out the filter with long nose pliers and reinstall it back after being washed.
3. Use the brush to clean the filter.
4. Reconnect the inlet pipe.

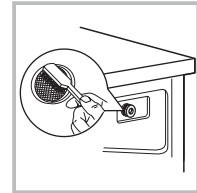
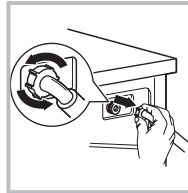

Note!

- If the brush is not clean, you can pull out the filter washed separately;
- Reconnect, turn on the tap.

Clean The Detergent Dispenser

1. Press down the arrow location on softener cover inside the dispenser drawer.
2. Lift the clip up and take out softener cover and wash all grooves with water.
3. Restore the softener cover and push the drawer into position.

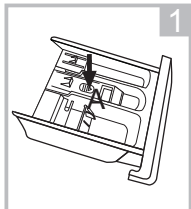

Pull out the dispenser drawer with press the A

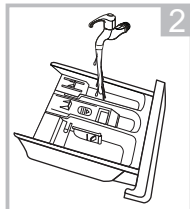

Clean the dispenser drawer under water

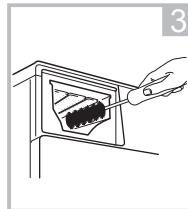

Clean inside the recess with an old toothbrush

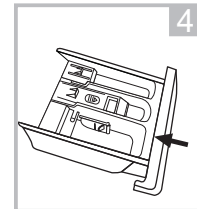

Insert the dispenser drawer

Note!

- Do not use alcohol, solvents or chemical products to clean the machine.

MAINTENANCES

Cleaning The Drain Pump Filter

⚠ Warning!

- Be careful of the hot water!
- Allow detergent solution to cool down.
- Unplug the machine to avoid electrical shock before washing.
- Drain pump filter can filter the yarns and small foreign matters from the washing.
- Clean the filter periodically to ensure the normal operation of washing machine.

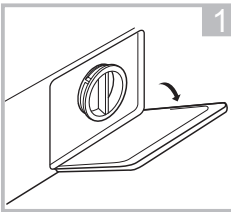

Open the lower cover cap

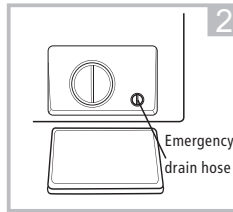

Rotate 90°C and pull out the emergency drain hose, and take off the hose cap

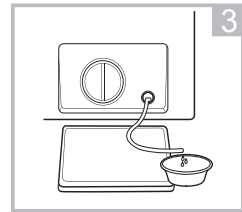

After water runs out, reset the drain hose

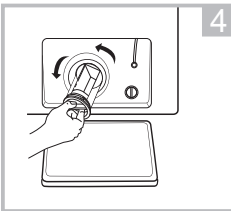

Open the filter by turning to the counter clockwise

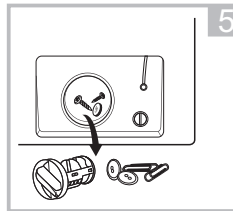

Remove extraneous matter

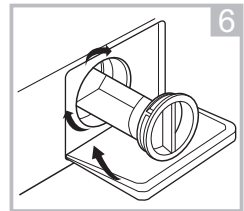

Close the lower cover cap

⚠ Caution!

- Make sure that valve cap and emergency drain hose are reinstalled properly, cap plates should be inserted aligning to hole plates otherwise water may leak.
- Some machines don't have emergency drain hose, so step 2 and step 3 can be skipped. Rotate lower cover cap directly to make water run into basin.
- When the appliance is in use and depending on the programme selected there can be hot water in the pump. Never remove the pump cover during a wash cycle, always wait until the appliance has finished the cycle, and is empty. When replacing the cover, ensure it is securely re-tightened.

MAINTENANCES

■ Trouble Shooting

The start of the appliance does not work or it stops during operation.
First try to find a solution to the problem, If not, contact the service centre.

Description	Reason	Solution
Washing machine cannot start up	Door is not closed properly	Restart after the door is closed Check if the clothes is stuck
Door can't be opened	Washer's safety protection design is working	Disconnect the power, restart the product
Water leakage	The connection between inlet pipe or outlet hose is not tight	Check and fasten water pipes Clean up outlet hose
Detergent residues in the box	Detergent is dampened or agglomerated	Clean and wipe the detergent box
Indicator or display does not light	Disconnect the power PC board or harness has connection problem	Check if the power is shut down and the power plug is connected correctly
Abnormal noise		Check if the fixing (bolts) have been removed Check it's installed on a solid and level floor

Description	Reason	Solution
E30	Door is not closed properly	Restart after the door is closed Check if the clothes is stuck
E10	Water injecting problem while washing	Check if the water pressure is too low Straighten the water pipe Check if the inlet valve filter is blocked
E21	Overtime water draining	Check if the drain hose is blocked
E12	Water overflow	Restart the washer
EXX	Others	Please try again first, call up service line if there are still troubles

Note!

- After the check, activate the appliance. If the problem occurs or the display shows other alarm codes again, contact the service.

MAINTENANCES

■ Technical Specifications

Power Supply 220-240V~,50Hz(EU)

MAX.Current 10A

Standard Water Pressure 0.05MPa~1MPa

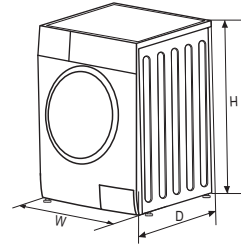

Model	Washing Capacity	Dimension (W*D*Hmm)	Net Weight	Rated Power
MFN75-S1403/C31E-AU(25)	7.5kg	595*565*850	68kg	2000W

MAINTENANCES

■ Testing methods

Model:MFN75-S1403/C31E-AU(25)

ADDITIONAL INFORMATION FOR Standard performance TESTING:
(AS/NZS 2040.1:2005+Amdt1-2007+Amdt2-2009)

1. Water connections: Cold & hot water connection
2. Water supply pressure: 320 kPa
3. Warm wash Program: Cotton Eco 60°C Display: 5:18/5:52
Cold wash program: Cotton Cold(no temperature display is cold wash)
4. Detergent type: Drum detergent
5. Detergent quantity: Default
6. Adding detergent:
The detergent is dissolved and added as Paragraph B7.3 of AS/NZS 2040.1
The detergent shall be dissolved in 1 L of water
7. Anti-sudsing agent: Max
8. Test load mass: 6.0kg/7.5kg
9. Water consumption: 61L/77L
10. Test Voltage: 220-240V~, 50Hz