

INSTRUCTION MANUAL

26L MICROWAVE OVEN ML2-EC26SF(BS)

Please review this instruction manual before operating.
Important safety instructions read carefully and keep for future reference.

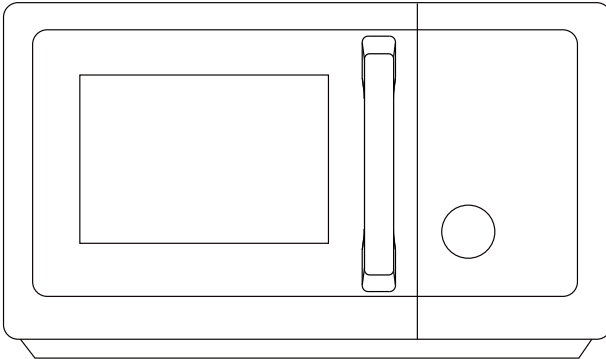

TOSHIBA

CONTENTS

PRODUCT SAFETY

Precautions to avoid possible exposure to excessive microwave energy	EN-01
Important safety instructions	EN-03
Grounding installation	EN-08
Cleaning	EN-10
Utensils.....	EN-11
Materials you can use in microwave oven	EN-12
Materials can not be used in microwave oven	EN-14

PRODUCT SETTING

Setting up your oven	EN-15
----------------------------	-------

INSTRUCTION FOR USE

Before using for the first time	EN-18
Operation	EN-19
1. Power levels	EN-20
2. Clock setting.....	EN-20
3. Kitchen timer.....	EN-21
4. Microwave cook	EN-22
5. Grill	EN-22
6. Combination	EN-23
7. Convection with preheat/without preheat.....	EN-24
8. Auto menu	EN-25
9. Weight defrost	EN-26
10. Time defrost	EN-27

11. Speedy cooking	EN-28
12. Lock function	EN-28
13. Mute Mode	EN-29
14. Inquiring function.....	EN-29
15. Air fry.....	EN-29

CLEANING AND MAINTENANCE

Cleaning	EN-31
Trouble shooting	EN-33



NOTE

BEFORE OPERATING THIS PRODUCT, READ, UNDERSTAND, AND FOLLOW THESE INSTRUCTIONS. BE SURE TO SAVE THIS BOOKLIST FOR FUTURE REFERENCE.

PRODUCT SAFETY

PRECAUTIONS TO AVOID POSSIBLE EXPOSURE TO EXCESSIVE MICROWAVE ENERGY

- (a). Do not attempt to operate this oven with the door open since this can result in harmful exposure to microwave energy. It is important not to break or tamper with the safety interlocks.
- (b). Do not place any object between the oven front face and the door or allow soil or cleaner residue to accumulate on sealing surfaces.
- (c). **WARNING:** If the door or door seals are damaged, the oven must not be operated until it has been repaired by a competent person.

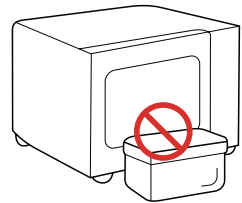

ADDENDUM

If the apparatus is not maintained in a good state of cleanliness, its surface could be degraded and affect the lifespan of the apparatus and lead to a dangerous situation.

SPECIFICATIONS

MODEL	ML2-EC26SF(BS)
RATED VOLTAGE	230-240 V~ 50 Hz
MICROWAVE POWER INPUT	1450 W
MICROWAVE POWER OUTPUT	900 W
RATED INPUT(GRILL)	1000 W
RATED INPUT(CONVECTION)	2100 W



NOTE

All pictures in this manual are for illustrative purposes only; these may be slightly different from the purchased equipment, please refer to the actual product.

IMPORTANT SAFETY INSTRUCTIONS



WARNING

To reduce the risk of fire, electric shock, injury to persons or exposure to excessive microwave oven energy when using your appliance, follow basic precautions, including the following:



Read and follow the specific: "**PRECAUTIONS TO AVOID POSSIBLE EXPOSURE TO EXCESSIVE MICROWAVE ENERGY**".



This appliance is not intended for use by persons (including children) with reduced physical, sensory or mental capabilities, or lack of experience and knowledge, unless they have been given supervision or instruction concerning use of the appliance by a person responsible for their safety.



Children should be supervised to ensure that they do not play with the appliance.





If the supply cord is damaged, it must be replaced by the manufacturer, its service agent or similarly qualified persons in order to avoid a hazard.



WARNING: Ensure that the appliance is switched off before replacing the lamp to avoid the possibility of electric shock.

IMPORTANT SAFETY INSTRUCTIONS

 **WARNING:** It is hazardous for anyone other than a competent person to carry out any service or repair operation that involves the removal of a cover which gives protection against exposure to microwave energy.

 **WARNING:** Liquids and other foods must not be heated in sealed containers since they are liable to explode.

 When heating food in plastic or paper containers, keep an eye on the oven due to the possibility of ignition.

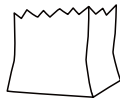

 Only use utensils that are suitable for use in microwave ovens.

 If smoke is emitted, switch off or unplug the appliance and keep the door closed in order to stifle any flames.

 Microwave heating of beverages can result in delayed eruptive boiling, therefore care must be taken when handling the container.

 The contents of feeding bottles and baby food jars shall be stirred or shaken and the temperature

 **WARNING :** When the appliance is operated in the combination mode, children should only use the oven under adult supervision due to the temperatures generated.

IMPORTANT SAFETY INSTRUCTIONS

checked before consumption, in order to avoid burns.

 **WARNING:** When the appliance is operated in the combination mode, children should only use the oven under adult supervision due to the temperatures generated.

 Failure to maintain the oven in a clean condition could lead to deterioration of the surface that could adversely affect the life of the appliance and possibly result in a hazardous situation.

 Only use the temperature probe recommended for this oven. (for ovens provided with a facility to use a temperature-sensing probe.)

 The microwave oven must be operated with the decorative door open. (for ovens with a decorative door.)

 This appliance is intended to be used in household and similar applications such as:

1. staff kitchen areas in shops, offices and other working environments;
2. by clients in hotels, motels and other residential type environments;
3. farm houses;
4. bed and breakfast type environments.

 The microwave oven is intended for heating food and beverages. Drying of food or clothing and heating of warming pads, slippers, sponges, damp cloth and similar may lead to risk of injury, ignition or fire.

IMPORTANT SAFETY INSTRUCTIONS

 The appliance is intended to be used freestanding.

 The rear surface of appliances shall be placed against a wall.

 The temperature of accessible surfaces may be high when the appliance is operating.

 The oven should be cleaned regularly and any food deposits removed. Please keep the waveguide area clean. Use soft damp cloth to clean it up when there is food splash residue on the waveguide area or the cavity. Failure to clean food residue may cause innocuous sparking or some smoke in the microwave cavity, discoloration of the cavity may also occur.

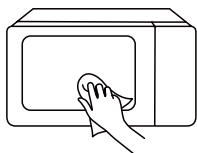

 The appliance must not be installed behind a decorative door in order to avoid overheating. (This is not applicable for appliances with decorative door.)

 Metallic containers for food and beverages are not allowed during microwave cooking.

 The appliance shall not be cleaned with a steam cleaner.

 Eggs in their shell and whole hard-boiled eggs should not be heated in microwave ovens since they may explode, even after microwave heating has ended.

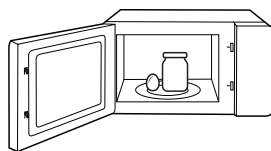

IMPORTANT SAFETY INSTRUCTIONS



The appliances are not intended to be operated by means of an external timer or separate remote-control system.



The microwave oven shall not be placed in a cabinet unless it has been tested in a cabinet.

**READ CAREFULLY AND KEEP FOR
FUTURE REFERENCE**

TO REDUCE THE RISK OF INJURY TO PERSONS GROUNDING INSTALLATION

This appliance must be grounded. In the event of an electrical short circuit, grounding reduces the risk of electric shock by providing an escape wire for the electric current.

This appliance is equipped with a cord having a grounding wire with a grounding plug. The plug must be plugged into an outlet that is properly installed and grounded.

WARNING - Improper use of the grounding can result in a risk of electric shock. Consult a qualified electrician or serviceman if the grounding instructions are not completely understood or if doubt exists as to whether the appliance is properly grounded. If it is necessary to use an extension cord, use only a 3-wire extension cord.

 DANGER	<p>Electric Shock Hazard: Touching some of the internal components can cause serious personal injury or death. Do not disassemble this appliance.</p>
--	--

TO REDUCE THE RISK OF INJURY TO PERSONS GROUNDING INSTALLATION



WARNING

Electric Shock Hazard:

Improper use of the grounding can result in electric shock. Do not plug into an outlet until appliance is properly installed and grounded.

1. A short power-supply cord is provided to reduce the risks resulting from becoming entangled in or tripping over a longer cord.
2. If a long cord or extension cord is used:
 - (1). The marked electrical rating of the cord set or extension cord should be at least as great as the electrical rating of the appliance.
 - (2). The extension cord must be a grounding-type 3-wire cord.
 - (3). The longer cord should be arranged so that it will not drape over the counter top or tabletop where it can be pulled on by children or tripped over unintentionally.

UTENSILS



CAUTION

Personal Injury Hazard:

It is hazardous for anyone other than a competent person to carry out any service or repair operation that involves the removal of a cover which gives protection against exposure to microwave energy. See the instructions on "**Materials you can use in microwave oven**" or "**Materials can not be used in microwave oven**"

There may be certain non-metallic utensils that are not safe to use for microwaving. If in doubt, you can test the utensil in question following the procedure below.

Utensil Test:

1. Fill a microwave-safe container with 1 cup of cold water (250ml) along with the utensil in question.
2. Cook on maximum power for 1 min.
3. Carefully feel the utensil. If the empty utensil is warm, do not use it for microwave cooking.
4. Do not exceed 1 min cooking time.

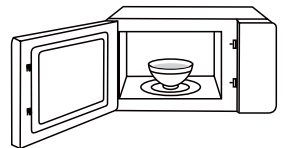





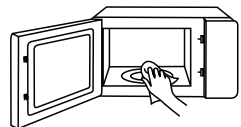











NOTE









KEEP THE CAVITY AND
WAVEGUIDE AREA CLEAN













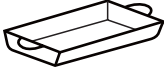



MATERIALS YOU CAN USE IN MICROWAVE OVEN

UTENSILS	REMARKS
 Browning dish	Follow manufacturer's instructions. The bottom of browning dish must be at least 3/16 inch (5mm) above the turntable. Incorrect usage may cause the turntable to break. 
 Dinnerware	Microwave-safe only. Follow manufacturer's instructions. Do not use cracked or chipped dishes. 
 Glass jars	Always remove lid. Use only to heat food until just warm. Most glass jars are not heat resistant and may break. 
 Glassware	Heat-resistant oven glassware only. Make sure there is no metallic trim. Do not use cracked or chipped dishes. 
 Oven cooking bags	Follow manufacturer's instructions. Do not close with metal tie. Make slits to allow steam to escape. 
 Paper plates and cups	Use for short-term cooking/warming only. Do not leave oven unattended while cooking. 
 Paper towels	Use to cover food for reheating and absorbing fat. Use with supervision for a short-term cooking only. 
 Parchment paper	Use as a cover to prevent splattering or a wrap for steaming. 

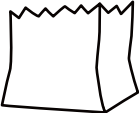
MATERIALS YOU CAN USE IN MICROWAVE OVEN

UTENSILS	REMARKS
 <p data-bbox="168 427 234 451">Plastic</p>	<p data-bbox="345 331 895 472">Microwave-safe only. Follow the manufacturer's instructions. Should be labeled "Microwave Safe". Some plastic containers soften, as the food inside gets hot. "Boiling bags" and tightly closed plastic bags should be slit, pierced or vented as directed by package.</p> 
 <p data-bbox="140 612 262 636">Plastic wrap</p>	<p data-bbox="345 531 893 611">Microwave-safe only. Use to cover food during cooking to retain moisture. Do not allow plastic wrap to touch food.</p> 
 <p data-bbox="125 777 277 801">Thermometers</p>	<p data-bbox="345 726 884 750">Microwave-safe only (meat and candy thermometers).</p> 
 <p data-bbox="147 940 255 963">Wax paper</p>	<p data-bbox="345 874 814 924">Use as a cover to prevent splattering and retain moisture.</p> 

MATERIALS CAN NOT BE USED IN MICROWAVE OVEN

UTENSILS	REMARKS
 <p>Aluminum tray</p>	May cause arcing. Transfer food into microwave-safe dish. 
 <p>Food carton with metal handle</p>	May cause arcing. Transfer food into microwave-safe dish. 
 <p>Metal or metal trimmed utensils</p>	Metal shields the food from microwave energy. Metal trim may cause arcing. 
 <p>Metal twist ties</p>	May cause arcing and could cause a fire in the oven. 
 <p>Paper bags</p>	May cause a fire in the oven. 
 <p>Plastic foam</p>	Plastic foam may melt or contaminate the liquid inside when exposed to high temperature. 
 <p>Wood</p>	Wood will dry out when used in the microwave oven and may split or crack. 

PRODUCT SETTING

SETTING UP YOUR OVEN

NAMES OF MICROWAVE OVEN PARTS AND ACCESSORIES

Remove the oven and all materials from the carton and oven cavity.

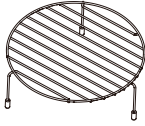

Higher Wire Rack
(For the convection,air fry,grill function)

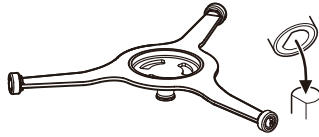

Turntable Ring Assembly

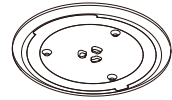

Glass turntable

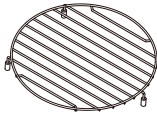

Lower Wire Rack
(For the convection,air fry,grill function)



Instruction Manual

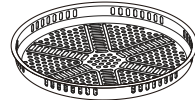

Bake Tray
(For the convection,air fry,grill function)

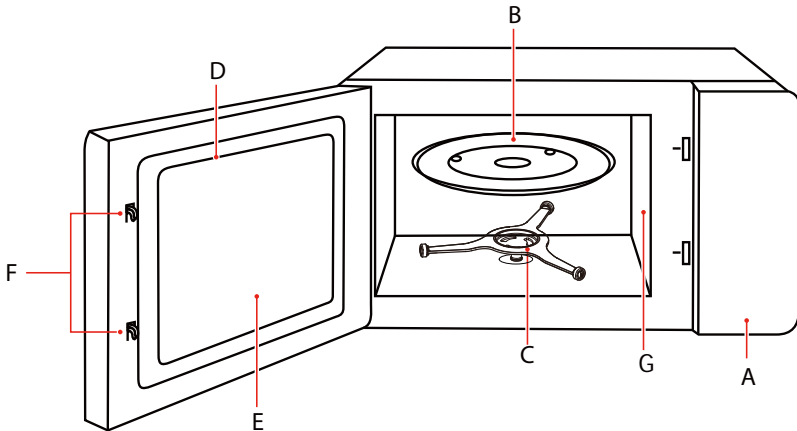

- A. Control panel
- B. Glass tray
- C. Turntable ring assembly
- D. Door assembly

- E. Observation window
- F. Safety interlock system
- G. Waveguide cover

SETTING UP YOUR OVEN

TURNTABLE INSTALLATION

Clean the cooking compartment and place the turntable.

For new installations, make sure all packaging and shipping tape has been removed from the turntable shaft.

Before using the appliance to prepare food for the first time, you will need to put the turntable in place correctly. You must clean the cooking compartment and accessories. You can also refer them to the cleaning section.

How to put the turntable in place:

1. Place the turntable ring assembly ② into the recess in the cooking compartment.
2. Place the glass tray ① on the turntable ring assemblies ②.

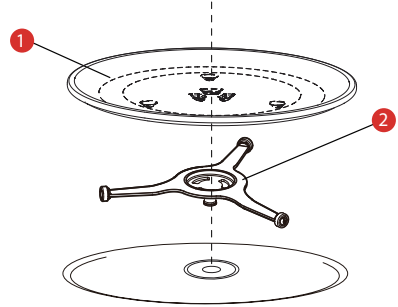

- 1) Glass Tray
2) Turntable Ring Assembly

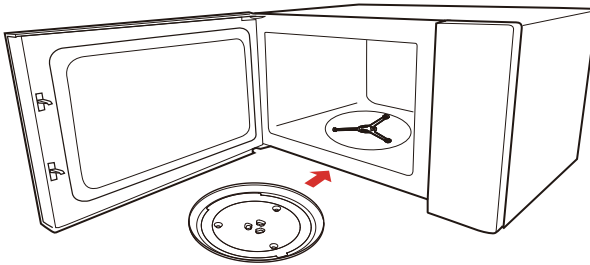

NOTE

- Never use the appliance without the turntable. Make sure that it is properly engaged. The turntable can turn clockwise or anti-clockwise.
- Never place the glass tray upside down. The glass tray should never be restricted.
- Both glass tray and turntable ring assembly must always be used during cooking.
- All food and containers of food are always placed on the glass tray for cooking.
- Never restrict the movement of the turntable.
- If glass tray or turntable ring assembly cracks or breaks, contact your nearest authorized service center.

COUNTERTOP INSTALLATION

Remove all packing material and accessories. Examine the oven for any damage such as dents or broken door. Do not install if oven is damaged.

Cabinet: Remove any protective film found on the microwave oven cabinet surface. Do not remove the waveguide cover that is attached to the oven cavity to protect the magnetron.

INSTALLATION

1. Select a level surface that provide enough open space for the intake and/or outlet vents.
 - a. The minimum installation height is 85cm.
 - b. The rear surface of appliance shall be placed against a wall. Leave a minimum clearance of 30cm above the oven. A minimum clearance of 20cm is required between the oven and any adjacent walls but behind is not consider.
 - c. Do not remove the legs from the bottom of the oven.
 - d. Blocking the intake and/or outlet openings can damage the oven.
 - e. Place the oven as far away from radios and TV as possible. Operation of microwave oven may cause interference to your radio or TV reception.

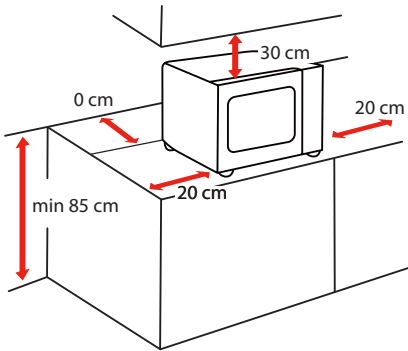

SIDE	DISTANCE (CM)
Top	30 cm
Left	20 cm
Right	20 cm
Behind	0 cm
Front	Open

2. Plug microwave oven into a standard household outlet. Be sure the voltage and the frequency is the same as the voltage and the frequency on the rating label.



NOTE

- Do not install oven over a range cooktop or other heat-producing appliance. If installed near or over a heat source, the oven could be damaged and the warranty would be void.

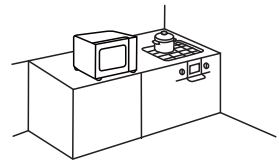

The accessible surface may be hot during operation

INSTRUCTION FOR USE

BEFORE USING FOR THE FIRST TIME

It is normal that the oven may produce unpleasant odors when it is used for the first time.

This section tells you what you need to do before using your microwave to prepare food for the first time. Read the section entitled "**PRODUCT SAFETY**" beforehand.

Before you can use your new appliance, you will need to put the turntable in place correctly. You must also clean the cooking compartment and accessories.



- Never use the appliance without the turntable.
- Make sure that it is properly engaged. The turntable can turn clockwise or anti-clockwise.

OPERATION

CONTROL PANEL AND FEATURES

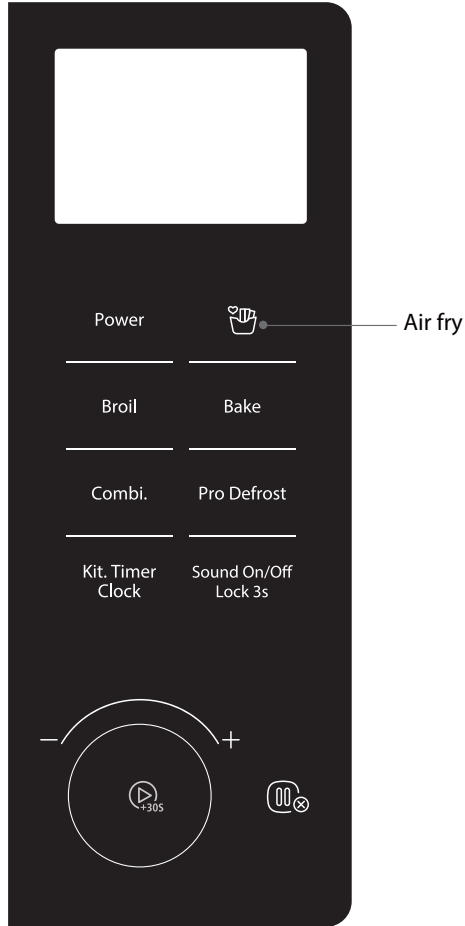

1. POWER LEVELS

Ten power levels are available.

LEVEL	POWER	DISPLAY
10	100%	P100
9	90%	P90
8	80%	P80
7	70%	P70
6	60%	P60
5	50%	P50
4	40%	P40
3	30%	P30
2	20%	P20
1	10%	P10

2. CLOCK SETTING

When the microwave oven is plugged into an outlet, "0:00" will display.

- a Press Kit.Timer/Clock twice, "00:00" displays.



- b Turn the knob to set the hour figures, it should be within 0-23.



- c Press Kit.Timer/Clock to confirm.



- d Turn the knob to set the minute figures, it should be within 0-59.



- e Press Kit.Timer/Clock to confirm.

Kit. Timer
Clock

3. KITCHEN TIMER

When the microwave oven is plugged into an outlet, "0:00" will display.

- a Press Kit.Timer/Clock once

Kit. Timer
Clock

- b Turn the knob to set the time, it should be within 0:05-95:00.



- c Press  to start counting down.



NOTE

- The Kitchen Timer setting is different from the Clock setting; it is simply a timer.
- During the Kitchen Timer function, no cooking function can be set into operation.

4. MICROWAVE COOK

When the microwave oven is plugged into an outlet, "0:00" will display.

Press Power more times to choose the power level.



a or

Press Power once, and then turn the knob to set the power level.



b Press  to confirm the power level.

c Turn the knob to set the time, it should be within 0:05-95:00.

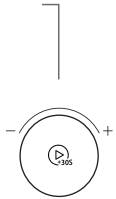



d Press  to start cooking.

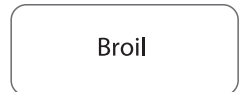

5. GRILL

a Press Broil once, "G-1" displays.



b Press  to confirm the mode.



c Turn the knob to set the time, it should be within 0:05-95:00.

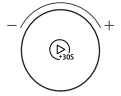

d Press  to start cooking.



- When half of the time has passed, the buzzer will sound to remind you to turn the food over. If no operation, the oven will continue working.

6. COMBINATION

Press Combi. more times to choose the mode.

Combi.

a or

Press Combi. once, C-1 displays, and then turn the knob to choose the mode.
"C-1~C-4" are available.

Combi.





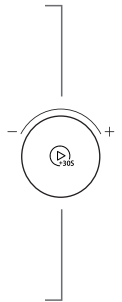

b Press  to confirm the mode.

c Turn the knob to set the time, it should be within 0:05-95:00.



d Press  to start cooking.

DISPLAY	ICON	MODE
C-1		Micro.+Convec.
C-2		Micro.+Grill
C-3		Grill+Convec.
C-4		Micro.+Grill+Convec.

7.CONVECTION WITH PREHEAT&WITHOUT PREHEAT

Press Bake more times to choose the convection temperature.

a or

Press Bake once, and then turn the knob to choose the convection temperature. 150°C, 160°C.....240°C are available.

b Press  to confirm the temperature.

c Press  to start Preheating.(if not preheating, skip this step) when the temperature has arrived,open then put food into oven and then close the door.

d Turn the knob to set the time,it should be within 0:05-95:00.

e Press  to start cooking.

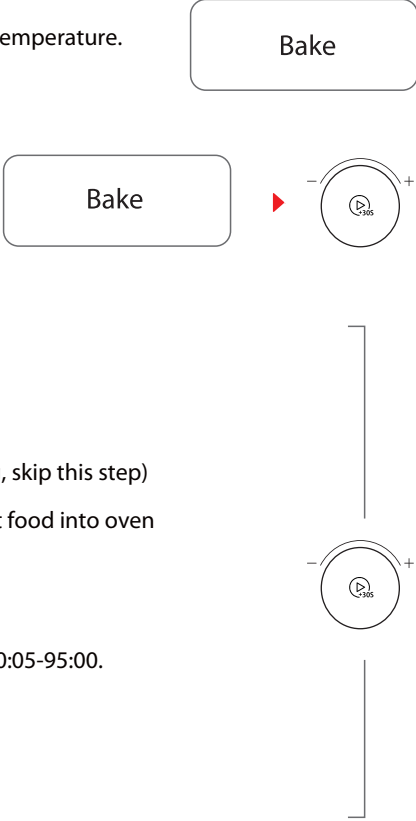

8. AUTO MENU

a In waiting state, turn the knob right to enter auto menu. "A01" displays, turn the knob repeatedly to choose the desired menu, 10 menus are available.

b Press  to confirm the menu.

c Turn the knob to set the weight of the food.

d Press  to start cooking.



MENU	WEIGHT/ PORTION	POWER LEVEL
A01 AUTO REHEAT	150g 250g 350g 450g 600g	P100
A02 POTATO	1 2 3	P100
A03 MEAT	150g 300g 450g 600g	P80
A04 VEGETABLE	150g 350g 500g	P100

MENU	WEIGHT/ PORTION	POWER LEVEL
A05 FISH	150g 250g 350g 450g 650g	P80
A06 PASTA	50g(with cold water 450g) 100g(with cold water 800g) 150g(with cold water 1200g)	P80
A07 SOUP	200g 400g 600g	P100
A08 CAKE	475g	with preheat 160°C CONVEC.160°C
A09 PIZZA	100g 200g 300g	C-4
A10 CHICKEN	500g 750g 1000g 1200g	C-4

9. WEIGHT DEFROST

a Press Pro defrost once, "dEF1" will display.

Pro Defrost

b Press  to confirm the menu.



- c Turn the knob to set the weight.
it should be within 100g-2000g.



- d Press  to start defrosting.



10. TIME DEFROST

- a Press Pro defrost twice, "dEF2" will display.

Pro Defrost

- b Press  to confirm the menu.

- c Turn the knob to set the time, it should be within 0:05-95:00.

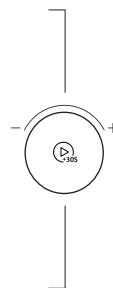

- d Press  to start cooking.

11. SPEED COOKING

- a Turn the knob left once to choose the cooking mode with 100% power level for 5 seconds directly.



- b Turn the knob to set the time, it should be within 0:05-95:00.



- c Press  to start cooking.



- a Press  once to cook with 100% power level with 30 seconds directly.



12. LOCK FUNCTION

- a To lock the microwave so that it cannot be operated by children or other unintended users, press Sound On/Off Lock 3s for 3 seconds.

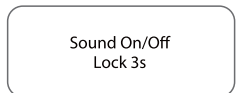

- b To unlock, press Sound On/Off Lock 3s pad for 3 seconds.

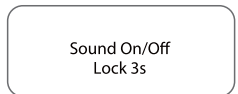

13. MUTE MODE

- a To activate the mute mode, in waiting state, press Sound On/Off Lock 3s once (about 1 sec.). "OFF" will display.

Sound On/Off
Lock 3s

- b To deactivate the mute mode, in mute mode, press Sound On/Off Lock 3s once (about 1 sec.). "On" will display.

Sound On/Off
Lock 3s

14. INQUIRING FUNCTION

- a When oven is cooking, press Kit.Timer/Clock, the current time will appear for three seconds in the display.

Kit. Timer
Clock

15. AIR FRY

- a In waiting state, press air fry once, "H01" displays



- b Turn the knob to choose the menu. "H01~H09" are available.



- c Press  to start cooking.



The menu chart

MENU	DISPLAY	WEIGHT	MODE	TIME
Frozen French Fries	H01	300g	C-5/C-6	6/16min.
Frozen Croquettes	H02	350g	C-6	16min.
Frozen Squid	H03	250g	C-6	16min.
Frozen Onion rings	H04	250g	C-6	16min.
Frozen Chicken nuggets	H05	350g	C-6	22min.
Frozen Escalope	H06	400g	C-6	24min.
Frozen Shrimps	H07	250g	C-6	18min.
Vegetable	H08	200g	C-6	16min.
Spring Rolls	H09	300g	C-6	18min.



NOTE

C-5:grill100%+convection240°C C-6:grill60%+convection240°C

CLEANING AND MAINTENANCE

CLEANING

With good care and cleaning, your appliance will retain its appearance and remain fully functioning for a long time to come. We will explain below how you should correctly care for and clean your appliance.



WARNING

- Scratched glass in the appliance door may develop into a crack. Do not use a glass scraper, sharp or abrasive cleaning aids or detergents.
- The surface of the appliance may become damaged if it is not cleaned properly. Microwave energy may escape. Clean the appliance on a regular basis, and remove any food remnants immediately.
- Do not immerse the appliance in water or clean under a jet of water.

Cleaning agent

To ensure that the different surfaces are not damaged by using the wrong cleaning agent, observe the information in the table. Wash new sponge cloths thoroughly before use.

Do not use:



Harsh or abrasive cleaning agents



Metal or glass scrapers to clean the door panels



Metal or glass scrapers to clean the door seal



Hard scouring pads or sponges



Cleaning agents with a high alcohol content

APPLIANCE FRONT

Hot soapy water:

Clean using a dish cloth and then dry with a soft cloth. Do not use metal or glass scrapers for cleaning.

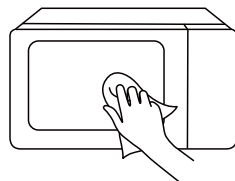

APPLIANCE FRONT WITH STAINLESS STEEL

Hot soapy water:

Clean using a dish cloth and then dry with a soft cloth. Remove splashes and patches of limescale, grease, starch and albumin immediately. Corrosion can form under these patches or splashes. Do not use glass cleaners or metal or glass scrapers for cleaning.

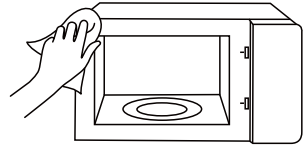

COOKING COMPARTMENT MADE OF STAINLESS STEEL

Hot soapy water or vinegar solution:

Clean using a dish cloth and then dry with a soft cloth. Do not use oven spray or any other aggressive oven cleaners or abrasive materials. Scouring pads, rough sponges and pan cleaners are also unsuitable. These items scratch the surface. Allow the interior surfaces to dry completely.

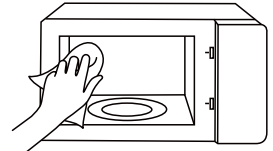

RECESS IN THE COOKING COMPARTMENT

Damp cloth:

Water must not be allowed to run into the appliance through the turntable drive. Dry the turntable drive with a cloth.

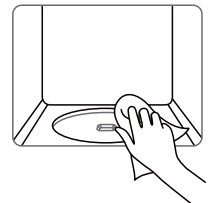

TURNTABLE AND ROLLER RING

Hot soapy water:

When placing the turntable back into its recess, it must engage properly.

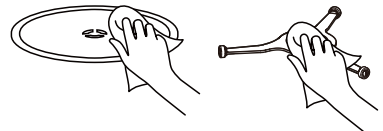

DOOR PANELS

Glass cleaner:

Clean with a dish cloth. Do not use glass scrapers.

TROUBLE SHOOTING

Check your problem by using the chart below and try the solutions for each problem. If the microwave oven still does not work properly, contact the nearest authorized service center.

TROUBLE	POSSIBLE CAUSE	POSSIBLE REMEDY
Oven will not start	<ul style="list-style-type: none"> a. Electrical cord for oven is not plugged in. b. Door is open. c. Wrong operation is set. 	<ul style="list-style-type: none"> a. Plug into the outlet. b. Close the door and try again. c. Check instructions
Arcing or sparking	<ul style="list-style-type: none"> a. Materials to be avoided in microwave oven were used. b. The oven is operated when empty. c. Spilled food remains in the cavity. 	<ul style="list-style-type: none"> a. Use microwave-safe cookware only. b. Do not operate with oven empty. c. Clean cavity with soft damp cloth.
Unevenly cooked foods	<ul style="list-style-type: none"> a. Materials to be avoided in microwave oven were used. b. Food is not defrosted completely. c. Cooking time, power level is not suitable. d. Food is not turned or stirred. 	<ul style="list-style-type: none"> a. Use microwave-safe cookware only. b. Completely defrost food. c. Use correct cooking time, power level. d. Turn or stir food.
Overcooked foods	Cooking time, power level is not suitable.	Use correct cooking time, power level.
Undercooked foods	<ul style="list-style-type: none"> a. Materials to be avoided in microwave oven were used. b. Food is not defrosted completely. c. Oven ventilation ports are restricted. d. Cooking time, power level is not suitable. 	<ul style="list-style-type: none"> a. Use microwave-safe cookware only. b. Completely defrost food. c. Check to see that oven ventilation ports are not restricted. d. Use correct cooking time, power level
Improper defrosting	<ul style="list-style-type: none"> a. Materials to be avoided in microwave oven were used. b. Cooking time, power level is not suitable. c. Food is not turned or stirred. 	<ul style="list-style-type: none"> a. Use microwave-safe cookware only. b. Use correct cooking time, power level. c. Turn or stir food.



According to Waste of Electrical and Electronic Equipment (WEEE) directive, WEEE should be separately collected and treated. If at any time in future you need to dispose of this product please do NOT dispose of this product with household waste. Please send this product to WEEE collecting points where available.

TWO YEARS LIMITED WARRANTY

This product carries a warranty stating that it will be free from defects in material and workmanship for a period of two year from the date of purchase. This warranty is valid for the original retail purchaser from the date of initial retail purchase and is not transferable. Keep your original sales receipt.

IMPORTANTE:

1. This warranty does not cover damages resulting from accident, misuse or abuse, lack of reasonable care, the affixing of any attachments not provided with the product, loss of parts, or subjecting the appliance to any but the specified (voltage. (Read directions carefully.)
2. This warranty is void if this product is ever used for other than private household

If service is required during the warranty period, properly pack your unit. We recommend using the original carton and packing materials.
If additional assistance is needed, please contact customer assistance

Tel: +64-9-930 0902
Email: service@jhappliance.co.nz
Website: <https://www.toshiba-lifestyle.com/nz>

Toshiba expressly disclaims all responsibility for consequential damages or incidental losses caused by use of the appliance.

Some country do not allow this exclusion or limitation of incidental or consequential losses so the foregoing disclaimer may not apply to you.

This warranty gives you specific legal rights, and you may also have other rights which may vary from state to state.

The serial number can be found on the backcabinet. We suggest that you record the serial number of your unit in thcspace below for future reference

Model Number: _____

Serial Number: _____

SAVE THIS FOR YOUR RECORDS

#DetailsMatter