

TSUBAKI DRIVE CHAINS & SPROCKETS

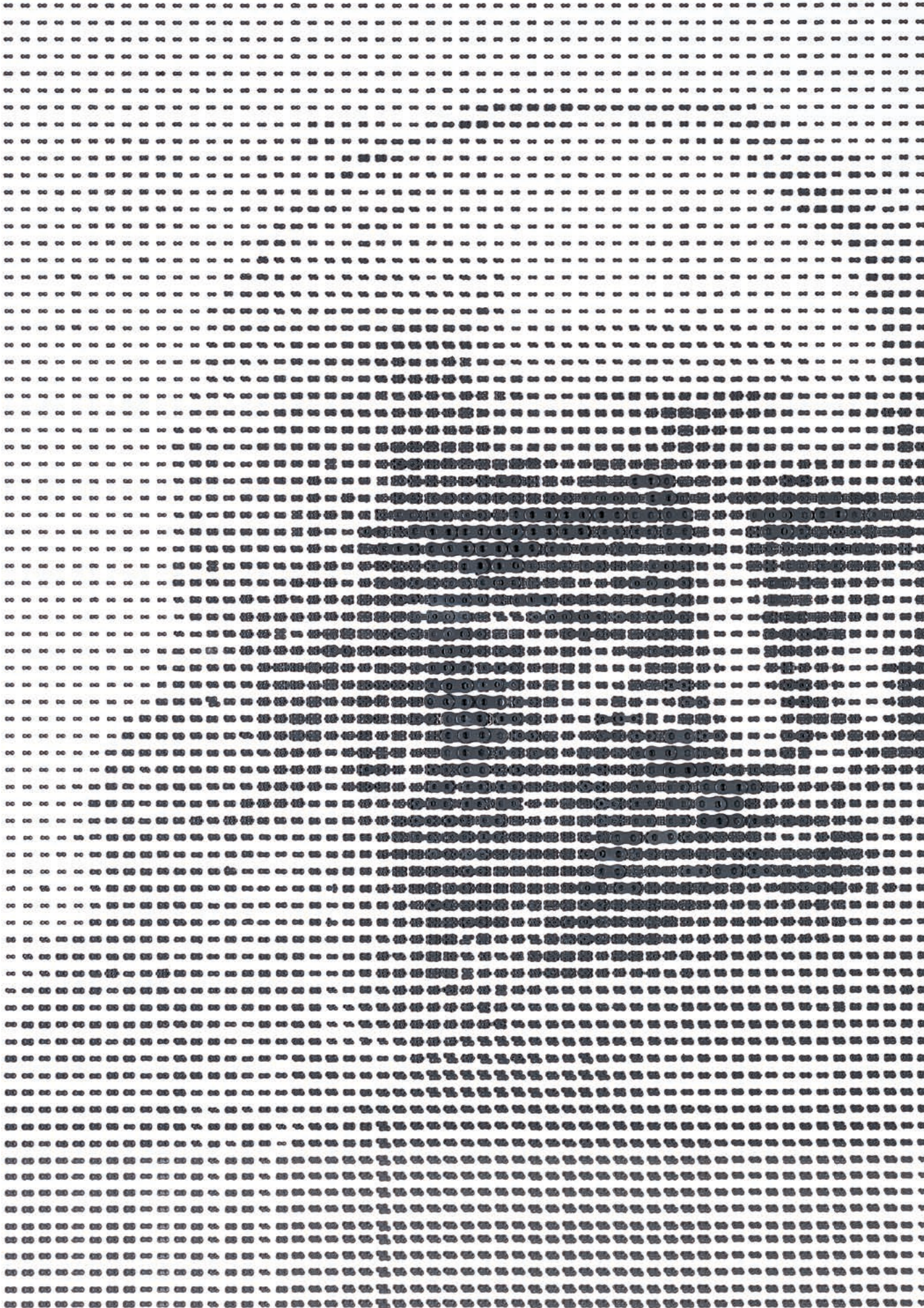



Leonardo da Vinci, founder of the roller chain (1452-1519)

Leonardo da Vinci, the genius of the Renaissance, devised the prototype of a roller chain that today is widely used as a drive chain. His foresight and advanced ideas are revealed in his notebooks, which contain sketches of an object that looks remarkably like a modern chain. The photo shows a portrait of da Vinci, made entirely out of link plates, on display in the main lobby of Tsubakimoto Chain's Kyotanabe Plant.

The Start of a New Era



Basic Environmental Policy of the Tsubaki Chain Group

Philosophy

The Tsubaki Chain Group recognizes that the protection of the global environment is one of the chief responsibilities of all mankind. It is our goal to show consideration for the environment in all of our business activities in order to contribute to a better tomorrow.

Policy

- Always be aware of the environmental effects of business activities, products and services, and strive to reduce the related environmental load from the perspective of global environmental protection.
- Streamline our organization for environmental protection and continually improve our environmental management systems.
- Comply with environmental laws, regulations and agreements.
- Help the entire workforce understand our basic environmental policy, and enhance their awareness of global environmental protection via environmental education, internal publication activities, etc.

Kyotanabe Plant Concepts

Kind consideration towards the global environment

Harmony and coexistence with the global environment

Pursuit of high efficiency and high quality

Courage to look to the future



Internationally Accredited Plant

Tsubakimoto Chain aims to make products that are people-friendly, environmentally friendly, and reliable. Tsubakimoto Chain acquired ISO9001 accreditation in 1995 and ISO14001 accreditation in 2003.



JQA-0911
Chain Division
JQA-QM9640
Environmental
Management
Department



JQA-EM3392
Kyotanabe Plant

Tsubakimoto Chain's Kyotanabe Plant is a state-of-the-art facility outfitted with the latest environmental systems to produce environment-friendly products that meet the needs of the times and our customers.

Trust Tsubaki's Robust Line-up to Increase Your Productivity

Tsubaki, bringing you an expansive line-up of drive chains and sprockets that fit your exact needs and drastically improve your productivity.

INDEX

New Products	Pg. 5
Before Use	Pg. 9
Notes on Using Roller Chain	Pg. 9
General Comparison of Transmission Elements	Pg. 10
Features and Precautions of Roller Chain Transmission	Pg. 10
Glossary	Pg. 11
Roller Chain Construction	Pg. 13
Roller Chain Product Line-up	Pg. 15
Ordering RS Roller Chain	Pg. 17

Chain



Standard Roller Chains Pg. 22

RS Roller Chains feature even higher kilowatt ratings and better performance for each size.

RS Roller Chain	Pg. 22
BS/DIN Standard RS Roller Chain	Pg. 51

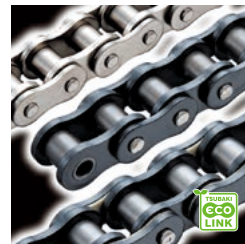

Lube-Free Roller Chains Pg. 59



Reduce your maintenance times, improve your work environment, and increase your productivity.

Lambda Chain	Pg. 61
Lambda Chain NP Series	Pg. 62
X-Lambda Chain	Pg. 63
Lambda Chain KF Series	Pg. 64
Heavy Duty Lambda Chain	Pg. 67
Curved Lambda Chain	Pg. 69
BS/DIN Lambda Chain	Pg. 70



Heavy Duty Roller Chains Pg. 73

Provides higher kilowatt ratings, allowable loads, and greater tensile strength than RS Roller Chain, allowing users to go 1 – 2 sizes down.

 Super Roller Chain	Pg. 75
 RS-HT Chain	Pg. 78
 Super-H Roller Chain	Pg. 81
Ultra Super Roller Chain	Pg. 82



Corrosion Resistant Roller Chains Pg. 83

Provide resistance to a variety of operating environments.

Stainless Steel Roller Chain (SS, NS, AS, and LSC Series)	Pg. 85
Surface Treated Roller Chain (NP,  NEP, and APP Series)	Pg. 88
Titanium Roller Chain	Pg. 91
Cold Resistant Roller Chain (KT Series)	Pg. 91
Low Noise Roller Chain	Pg. 92
Poly Steel Chain	Pg. 94
Curved Stainless Steel Roller Chain	Pg. 94



Specialty Roller Chains Pg. 95

Chains designed for special applications.

RS Curved Roller Chain	Pg. 95
Leaf Chains	Pg. 96



Eco Link Mark

These products meet Tsubaki's voluntary eco assessment criteria.



Caution

The chains, sprockets, and other products appearing in this catalog are manufactured with care. However, if not properly selected, handled, or maintained, chains may break, resulting in serious accident. Use design materials, selection criteria, and instruction manuals as reference for selecting, handling, and maintaining chains and sprockets, and confirm any uncertainties with the manufacturer before proceeding.



Sprockets

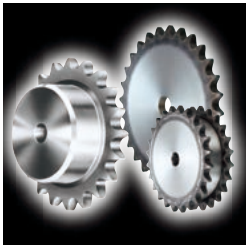

RS Sprocket Standard Series

Wide selection of standardized sprockets for general use RS Roller Chain.

Standard Pilot Bore Type SprocketsPg. 22
RS Sprocket Selection GuidePg. 102
TOUGH TOOTH SprocketsPg. 103
2A Type SprocketsPg. 106
Single Dual Type SprocketsPg. 107
Stainless Steel SprocketsPg. 113
Engineering Plastic SprocketsPg. 117

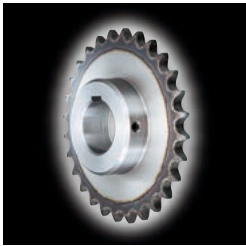

Fit Bore Series Pg. 118

Each model is provided with a finished bore, keyway, and set screws.

Finished Bore SprocketsPg. 119
Easy Bore Finishing ServicePg. 122

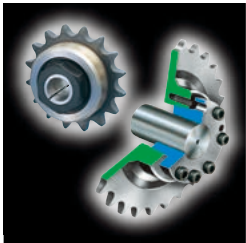

Lock Series Pg. 127

Keyless friction type integrated coupling sprockets

Lock Series S TypePg. 127
Lock Series N TypePg. 139

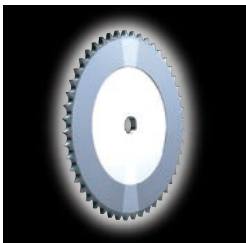

Specialty Sprockets

BS/DIN Sprockets and other sprockets for special applications

BS/DIN RS Roller Chain SprocketsPg. 108
Torque Limiter SprocketsPg. 141
Sprocket and Shaft SetsPg. 157



Pin Gear Drives Pg. 144

Drive units utilizing Tsubaki's long experience in pin gear drives to provide better performance and easier mounting. (Available in linear and drive models.)

Chain Type Pin Gear SprocketsPg. 144
Pin Gear Drive UnitsPg. 147



Accessories



Accessories (Peripheral Instruments) Pg. 158

Peripheral instruments for your chain maintenance needs.

Chain TensionersPg. 159
FR Idler SprocketsPg. 163
Chain Cutting ToolsPg. 165
Chain Connecting ToolsPg. 166
End FixturesPg. 167
Automatic Lubricator for Roller ChainPg. 168
Chain Elongation ScalePg. 170

Sprocket Engineering Information Pg. 142

Roller Chain Selection Pg. 171

1. Selection GuidePg. 172
2. Service FactorsPg. 174
3. Provisional Selection GraphPg. 175
4. Selection FormulaePg. 177
5. General SelectionPg. 180
6. Allowable Load SelectionPg. 182
7. Example of Lifting TransmissionsPg. 187
8. Calculating Moment of InertiaPg. 189
9. Example of Shuttle TractionPg. 190
10. Pin Gear Drive SelectionPg. 191
11. Temperature SelectionPg. 197
12. Special Selection Method for Corrosion Resistant Roller ChainPg. 197
13. Corrosion Resistance Reference Guide for Corrosion Resistant Drive Chains and SprocketsPg. 198

Handling Roller Chains and Sprockets Pg. 199

1. How to Cut Roller ChainPg. 199
2. How to Connect Roller ChainPg. 200
3. Roller Chain LubricationPg. 201
4. Layout and InstallationPg. 203
5. SprocketsPg. 205
6. Chain Test RunPg. 206
7. Roller Chain InspectionPg. 206
8. Cautions on Use in Special EnvironmentsPg. 210
9. TroubleshootingPg. 211

Roller Chain Inquiry Sheet Pg. 215

For Safe Use Pg. 216



Tsubaki G8 Series Drive Chain

G8 Series RS Roller Chain



Pg. 27



20% longer wear life
(compared to G7 Series)

Anti-rust lubrication minimizes tackiness and increases handleability!

Evolution of Chain Wear Life

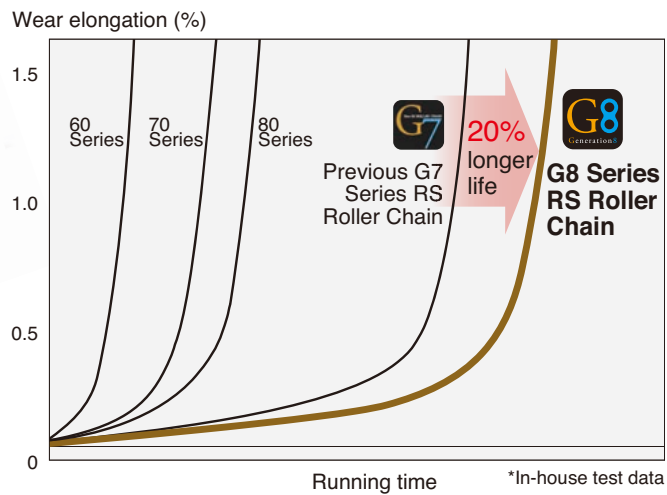

G8 Series Lambda Chain



Pg. 59



Oil impregnated sintered bushes use NSF-H1 certified oil

Basic Lambda Chain construction

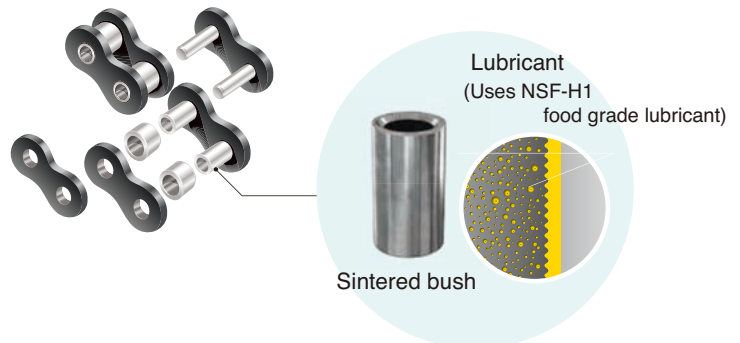

Long life without additional lubrication

G8 Series Lambda Chain can offer up to twice the wear life of previous Lambda Chain under particular conditions.

*In-house test results; actual results will vary depending on operating conditions.

G8 Series Heavy Duty Chain

Super Chain/RS-HT Chain/Super-H Chain



Super Chain

5-10% higher maximum allowable load than the previous series!

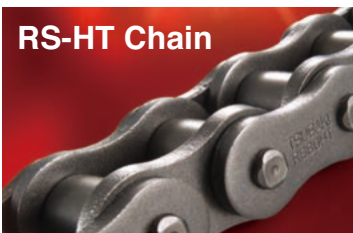

RS-HT Chain

Twice the wear life of the previous series!

Slip fit connecting links now available!



Super-H Chain

20% higher max. allowable load than the previous series!

Comparison of min. tensile strengths and max. allowable loads

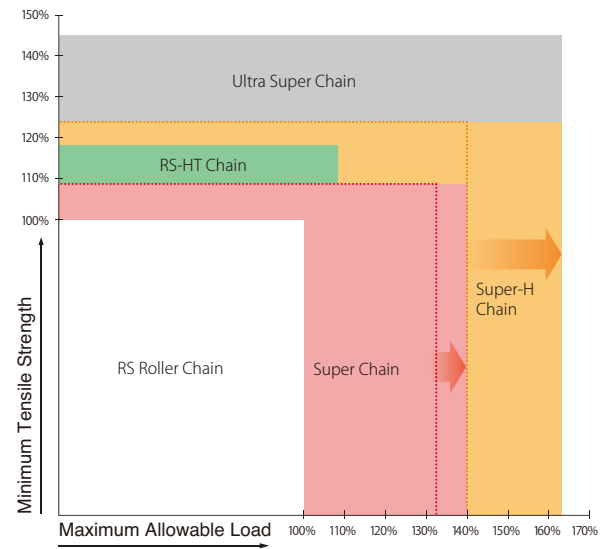

Note: With RS Roller Chain min. tensile strength and max. allowable load as benchmark (100).

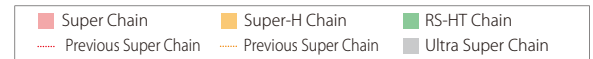

Corrosion Resistant Chain

G8 Series NEPTUNE CHAIN®



Tough against water and alkalis
No strength reduction
Lower environmental load



Superb Corrosion Resistance

	Corrosion Resistance		Chemical Resistance
	Salt water spray tests*	1000ppm sodium hypochlorite	5% sodium hydroxide
NEPTUNE	700 hours 	2000 hours 	2000 hours
Previous series	700 hours 	2000 hours 	15 hours

*Salt water spray tests in accordance with JIS-Z-2371.

Tsubaki RS Sprockets

RS Sprockets are perfect for G8 Series RS Roller Chain!

RS Sprockets

Pg. 21



High quality sprockets with overwhelmingly superior tooth surface hardness and hardened layer depth

Sprockets for general use drive chain are strong enough to handle the chain, while the wear resistance of the teeth is as important as the chain itself.

Tsubaki offers standard pilot bore type sprockets as well as standardized Strong Series sprockets, TOUGH TOOTH Sprockets, and a wide variety of other hardened tooth sprockets.

Comparison of tooth hardening

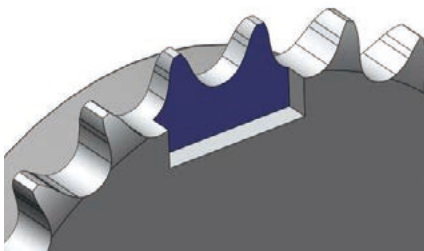

Comparison of tooth hardness and hardened layer depth

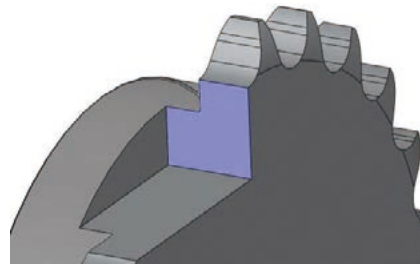

Cross-sectional observation of tooth hardening (hardened layer is gray)



Tsubaki sprocket Co. A

Co. B

Comparison of tooth hardened layer



Tsubaki sprocket Co. A

Co. B

Comparison of tooth wear under load tests

Wear on RS40 sprockets after 500 hrs running time. The Tsubaki sprocket has overwhelmingly superior wear resistance.

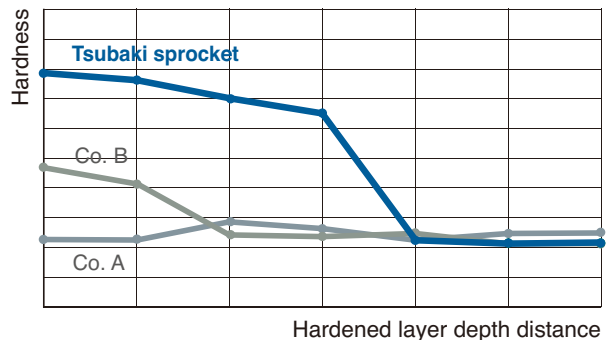
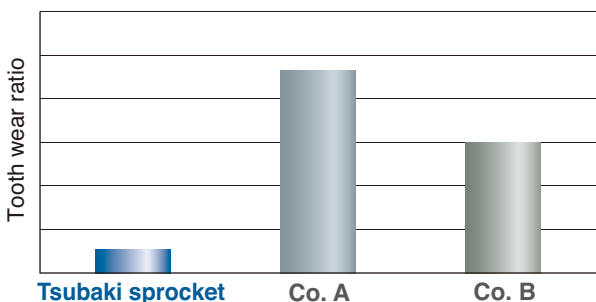

RS TOUGH TOOTH Sprockets



A stronger, more durable sprocket

Durable Teeth use induction hardened carbon steel

Strong Welded hub uses new material that is 43% stronger

Wear resistant Optional special surface coating available

TOUGH TOOTH sprockets have increased strength and durability to bring out the best in Tsubaki's G8 Series Heavy Duty Drive Chains.

Stronger hubs

Comparison of hub kW ratings (ex. using RS80-SUP-H-1)

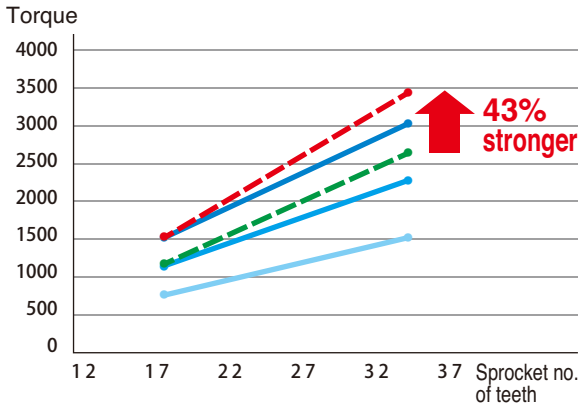

- Torque generated by chain kW ratings (100%)
- Torque generated by chain kW ratings (75%)
- Torque generated by chain kW ratings (50%)
- - Torque calculated from TOUGH TOOTH hub strength
- - Torque calculated from previous hub strength

Extended hubs and other specialty specifications were needed to ensure hub strength when earlier designs were not strong enough. TOUGH TOOTH sprockets feature 43% stronger hubs while still maintaining standard dimensions!

Space and cost savings!

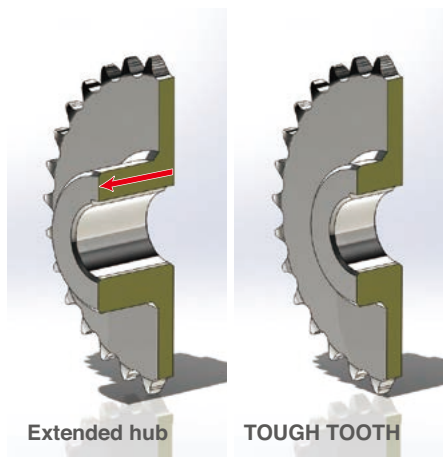

Example of fracture due to insufficient hub strength

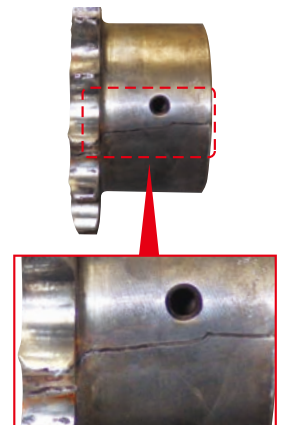

Special surface coating (optional)

Perfect for when you want to reduce replacement frequency and for use in harsh environments thanks to its increased surface hardness (over HV800). The teeth also wear less, which can reduce the rate of chain elongation.



Coated sprocket

Before Use

NOTE

With the exception of endless chains, the transmission power tables in this catalog are based on use with connecting parts (connecting links or offset links).

See page 16 for details on connecting parts.

The dimensions shown in this catalog are nominal dimensions and differ from actual dimensions.

This drive chain catalog explains how to select, install and maintain all listed Tsubaki Roller Chains. Numerical figures are indicated in both SI and gravimetric units.

Read through this catalog before use to ensure proper selection and usage. Also, carefully inform persons involved in installation and maintenance of all pertinent matters.

Ordinary Transmission



Lifting Applications

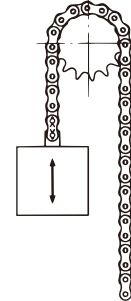

Shuttle Traction

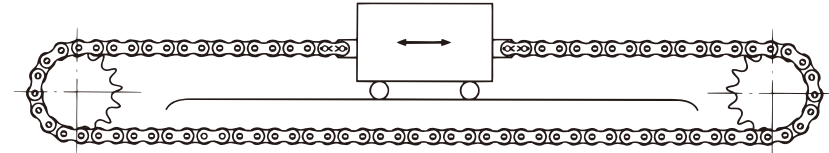

Pin Gear Drive

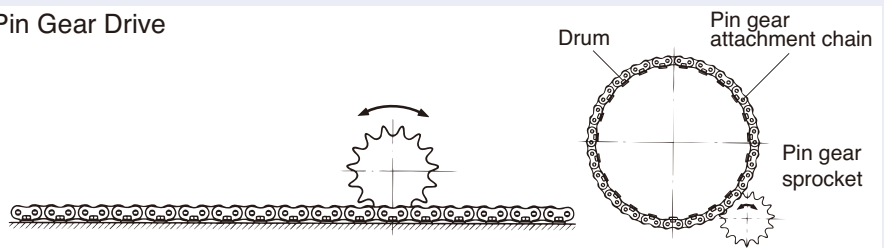

⚠ Notes on Using Roller Chains

NOTE



- When using a roller chain in lifting applications, keep clear from underneath the load.
- If there is the possibility of serious accident or death in the event of roller chain breakage during lifting or other applications, install reliable safety devices to prevent accidents.
- Inspect and replace worn roller chain periodically.
- Roller chains can break and climb up on the sprocket from wear elongation. (Lubrication can extend service life against wear elongation. Tsubaki also offers lube-free drive chains that deliver long-lasting service without lubrication.)
- Overload may cause roller chain to break. (Avoid breakage by properly selecting products with consideration of inertia, etc. Tsubaki offers heavy-duty drive chains in identical sizes that deliver the high strength of larger chains.)
- Roller chains can break due to corrosion and other environmental conditions. (Avoid breakage by preventing exposure to corrosive liquids, atmospheres, etc. Tsubaki offers excellent corrosion-resistant drive chains.)
- Correctly install roller chain to avoid misalignment or uneven wear and possible breakage.

General Comparison of Transmission Elements

The following table compares roller chains to other power transmission mechanisms such as toothed belts, V-belts and gears. Generally speaking, roller chains are often used in economical power transmission suited to low speed and high loads. However, it is also possible to use chain in high-speed applications such as camshaft drives for automobiles.

Transmission Mechanism		Roller Chain	Toothed Belt	V-belt	Gear
Synchronicity		◎	◎	×	◎
Transmission Efficiency		◎	◎	△	◎
Anti-shock		△	○	◎	×
Noise & Vibration		△	◎	◎	×
Ambient Conditions		Avoid water and dust (Corrosion-resistant drive chains available)	Avoid heat, oil, water and dust	Avoid heat, oil, water and dust	Avoid water and dust
Space, Weight	High speed, light load	×	◎	○	○
	Low speed, heavy load	◎ Compact, lightweight	△ Slightly heavy pulleys	×	○ Needs high strength due to low number of engaging teeth.
Lubrication		×	◎	◎	×
		Required	Not required	Not required	Required
Layout Freedom		◎	○	△	×
Excess Load on Shaft		◎	○	×	◎

◎Excellent ○Good △Fair ×Poor

Features and Precautions of Roller Chain Transmissions

■ Features

1. Accommodate large speed reductions/increases (usually up to 1:7).
2. Chains can accommodate long shaft center distances (normally less than 4 m), and are more versatile.
3. It is possible to use chain with multiple shafts or drives with both sides of the chain.
4. Easy installation and replacement (easy to cut and connect chains).
5. Drive use is possible even when shafts are vertical, as long as the chain receives support in short distances between the shafts.
6. Standardization of chains under the American National Standards Institute (ANSI), the International Standardization Organization (ISO), and the Japanese Industrial Standards (JIS) allow ease of selection.
7. The sprocket diameter for a chain system may be smaller than a belt pulley while transmitting the same torque.
8. Sprockets are subject to less wear than gears because sprockets distribute the load over their many teeth.
9. High shock absorbency compared to gears.

■ Precautions

1. Chains have speed variation, called chordal action, which is caused by the polygonal effect of the sprockets.
(Shock can be reduced under the same speed ratio by either reducing the chain pitch or increasing the number of sprocket teeth.)
2. During transmission, a method of lubrication suitable to the chain's speed is necessary.
3. Chains wear and elongate. Measures for adjusting chain slack need to be considered.
4. Chains are weak when subjected to loads from the side. They need proper alignment.

Glossary

1. ANSI Standard Minimum Tensile Strength (Tensile Breakage Strength)

This is the minimum tensile strength determined by ANSI Standard. If a roller chain breaks from a tensile load below this value, then it is non-compliant. With multi-strand roller chain, the single strand value is multiplied by the number of strands. (ASME B29.1-2011)

2. Tsubaki Average Tensile Strength

This is a fracture load reading obtained after a long period of actual tensile strength testing of a large number of chain strands. Naturally, a roller chain may actually break at a higher or lower value than this, so it does not represent a guaranteed value. This value varies depending on the manufacturer.

3. Tsubaki Minimum Tensile Strength

This is a minimum value determined by statistical processing at Tsubaki. If any roller chain fractures by a tensile load below this value, then it is non-compliant. This value varies depending on the manufacturer.

Fig. 1 Relationship between three tensile strengths

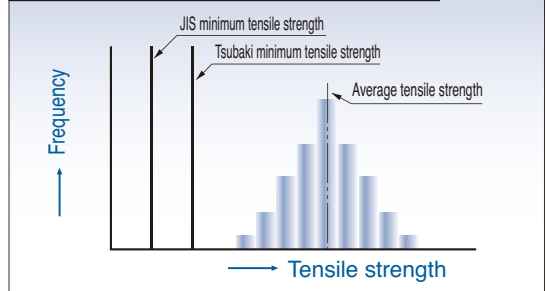

Testing Method

As shown in Fig. 2, a roller chain with over seven links is fixed at both ends by clevises and is stretched until breakage occurs (JIS B 1801:2014). The type of fracture is indicated by breakage of the roller chain or failure of its parts (Fig. 3.)

Fig. 2 Tensile strength test

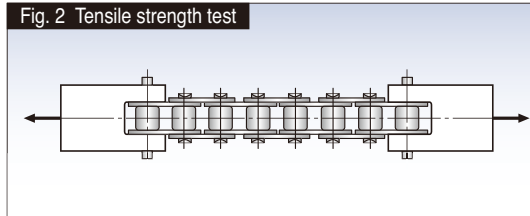
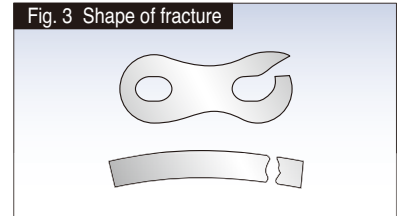

Fig. 3 Shape of fracture



4. Maximum Allowable Load

The maximum allowable load of roller chain (excluding Stainless Steel Chain and Engineering Plastic Chain*) is the value derived from the lowest fatigue limit. When a load lower than this value is repetitively applied to the roller chain, fatigue failure will never occur.

According to the former JIS B 1801-1997, the maximum allowable load indicates a breakage load of $P_{max} = (P_m + P_a) = 2.2P_a$ at a frequency of 5×10^6 , when a new roller chain with over five links receives a repetitive load in linear operation. (Fig. 4)

Tsubaki standards and catalog values are for 10^7 repetitions, or $2P_a$. In other words, if Tsubaki's maximum allowable load is indicated as maximum load (P_{max}), then values in this catalog would increase 10%.

* Stainless steel and engineered plastic chains:

Maximum allowable load is determined from specifying the surface pressure between pins and bushes based on wear performance.

Fig. 4 Summary chart of repetitive load

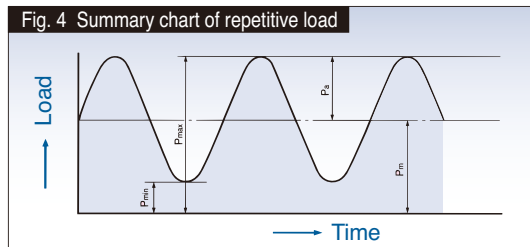

Note that strength of offset links may be lower than the chain itself.

(Refer to the allowable load selection method on pg. 182.)

5. Kilowatt Ratings Table

RS Roller Chain, SUPER Roller Chain, Heavy Duty Chain, and Low Noise Drive Chain kilowatt ratings tables show kW values for 15,000 hours of operation using a two-shaft drive and 100 pitches of roller chain under conditions 1 - 5 below.

The kW ratings table of Lambda Chain is based on conditions 1 - 4 and shows kW rating values when Lambda Chain is used with two shafts. Lambda Chain has more than seven times the wear elongation of Standard RS Roller Chain operated without lubrication (#120 and #140 are over 2.5 times). X-LAMBDA has more than five times the wear elongation life of Lambda Roller Chain.

- 1) The chains are operated under ordinary conditions where the ambient temperature is -10°C to 60°C ($+14^{\circ}\text{F}$ to $+140^{\circ}\text{F}$) and there is no abrasive dust.
- 2) There are no negative effects from corrosive gasses or high humidity.
- 3) The two shafts are level and the chains are properly installed. (See item 4 on pg. 203.)
- 4) There is minimal fluctuation in load during transmission.
- 5) The recommended lubrication system and lubricant shown in the kW ratings tables is used for RS Roller Chain and Super Roller Chain. (See pgs. 201 - 202.)

6. Moment of Inertia ($I / J / \text{GD}^2$)

Moment of inertia is used to show the degree of inertia in rotational movement; in other words, "rotation difficulty", or "rotation ease." This is equivalent to the mass (weight) of the object being used for straight-line transmission.

Moment of inertia is shown in the SI units table as:

$$I = mk^2 \text{ (kg} \cdot \text{m}^2 \text{ m: mass of rotating body k: turning radius)}$$

It is shown in the Gravimetric units table as:

$$J = \frac{G}{G} \cdot K^2 \text{ (kgf} \cdot \text{m} \cdot \text{s}^2 \text{ G: mass of rotating body G: gravitational acceleration).}$$

Although, $\text{GD}^2 = 4GJ$ (D: diameter of rotating body) is generally being used now in place of moment of inertia.

7. Total Length Tolerance of Roller Chain

Length test method and length tolerance are specified in JIS B 1801:2014. The length tolerance of any individual size when subjected to a measured load (e.g. 500 N [50.99 kgf] for RS 80) specified in JIS is 0 to +0.15% of the reference length. The reference length is calculated by multiplying the reference pitch (P) by the number of links. (Applicable to products bearing a JIS identification number.)

8. Elastic Elongation of Chain under Load

An elastic elongation curve of a chain under load looks as shown below. Values shown here are the standard references for single-strand RS Roller Chains. Actual values may slightly differ. Do not apply loads exceeding the maximum allowable load to roller chains.

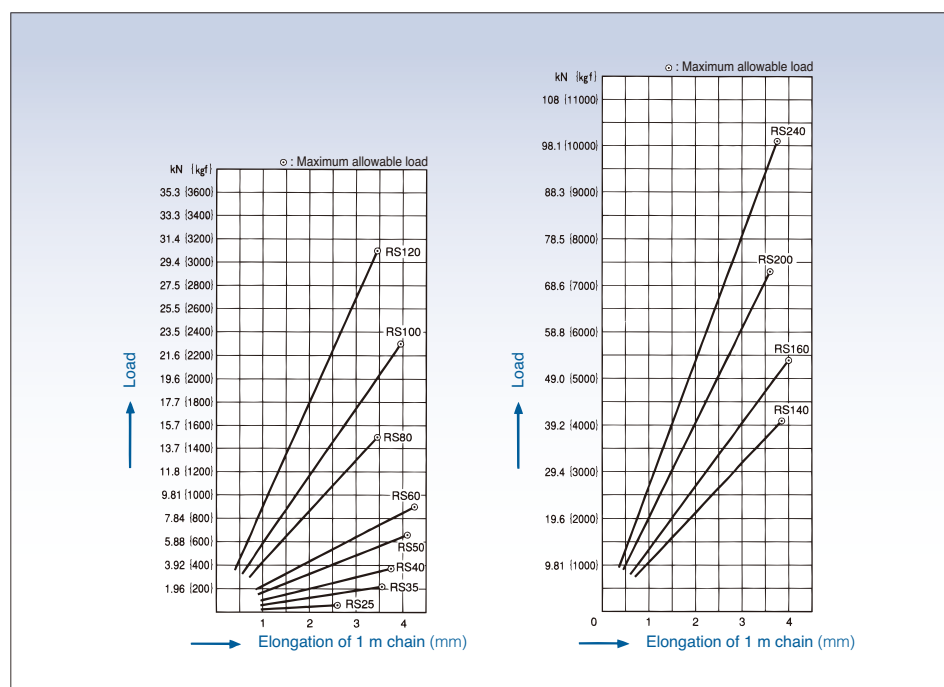

Roller Chain Construction

1. Basic Structure (Photo: RS Roller Chain)

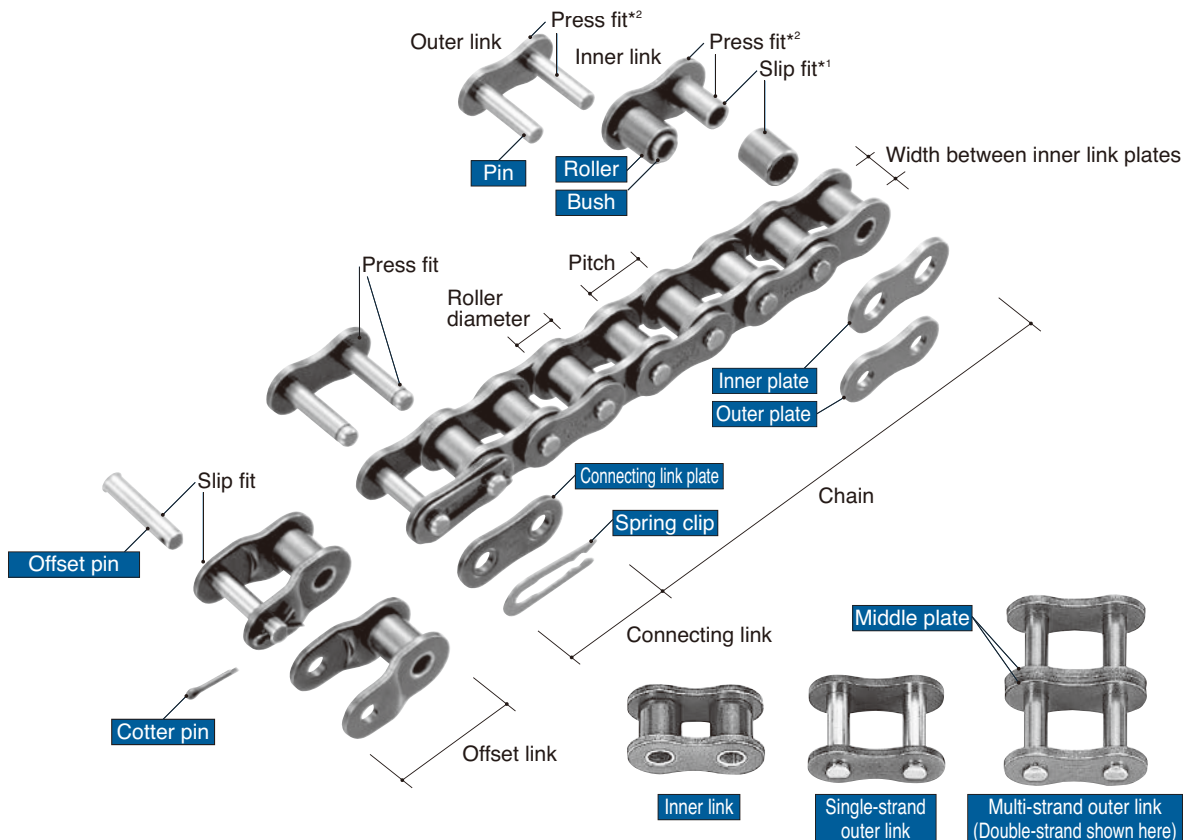

Basic Three Dimensions

The pitch, roller diameter, and width between inner link plates are considered the basic three dimensions of a roller chain. When these dimensions are identical, a roller chain and sprocket are dimensionally compatible.

The dimensions shown in this catalog are nominal dimensions and differ from actual dimensions.



Spring clips, cotter pins and spring pins are essential parts that prevent connecting plates from falling off, maintaining the strength of the chain itself. Always install these parts.

*1 Slip Fit

When the shafts (pins and bushes) and holes are fitted together, there is a continuous loose fit. This is a fit where the range of tolerance for the hole is larger than the range of tolerance for the shaft.

*2 Press Fit

When the shafts (pins and bushes) and holes are fitted together, there is a continuous interferential fit. This is a fit where the range of tolerance for the hole is smaller than the range of tolerance for the shaft.

■ Plate

The plate bears the tension placed on the chain. Usually this is a repetitive load, but sometimes it is accompanied by shock. Therefore, the plate must have not only great static tensile strength, but also must hold up to the dynamic forces of load and shock.

■ Pin

The pin is subject to shearing and bending forces transmitted by the plate. At the same time, it forms a load-bearing part, together with the bush, when the chain flexes during sprocket engagement. Therefore, the pin needs high tensile and shear strength, resistance to bending, and sufficient endurance against shock and wear.

■ Bush

The bush is subject to complex forces from all parts, especially from the repetition of shock loads when the chain engages the sprocket. Therefore, the bush needs extremely high shock resistance. In addition, the bush forms a load-bearing part together with the pin, and as such requires great wear resistance.

■ Roller

The roller is subject to impact load as it strikes the sprocket teeth during chain engagement with the sprocket. After engagement, the roller changes its point of contact and balance. It is held between the sprocket teeth and bush, and moves on the tooth face while receiving a compression load. Therefore, it must be resistant to wear and still have strength against shock, fatigue and compression. RS11 / 15 / 25 / 35 do not have rollers.

■ Inner Link

Two bushes are press fit into two inner plates, and rollers are inserted to allow rotation around the outside of the bush. This is the same for single-strand and multi-strand chain.

■ Outer Link and Middle Plate

The pin link consists of two pins that have been press fit into two outer plates. With multi-strand roller chain, a middle plate is added to the pin link. The middle plate is slip fit for standard RS Roller Chain and press fit for Super Roller Chain.

*The dimensions shown in this catalog are nominal dimensions and differ from actual dimensions.

2. Assembly Parts

Roller Chains are usually made up of a number of connected links in an endless formation, or used by fixing the chain ends, but the need for connecting links will eventually arise. Although offset links can be used when there are an odd number of links in the roller chain, please use a design that requires an even number of links as much as possible. Please note that connecting links and offset links are normally coated with an anti-rust agent only. Always thoroughly lubricate pin and bush when assembling.

2.1 Connecting Links

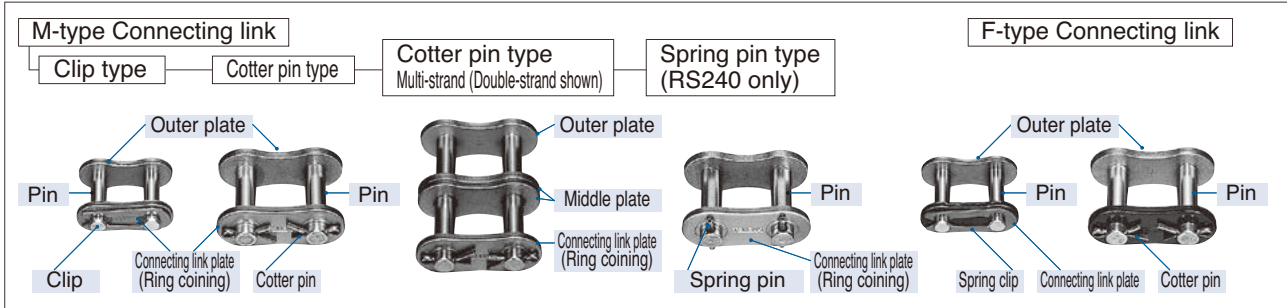

Chain type	Connecting link type	Pin / Connecting link plate fitting	Connecting link plate fastening	Note
RS Roller Chain	M-type connecting link Code: CL	Slip fit (M)	Spring clip Cotter pin Spring pin	<ul style="list-style-type: none"> For multi-strand chain, make sure the plate with *Ring Coining is on the outermost side when assembling. Operating speed is indicated by the white area in the kW ratings table.
	F-type connecting link * Code: FCL	Press fit	Spring clip, Cotter pin Spring pin T-pin	<ul style="list-style-type: none"> Make sure to use the chain according to the specified applications on page 172 and within the speed region of the colored area in the kW rating tables.
Lambda Chain	M-type connecting link Code: CL	Slip fit (M)	Spring clip Cotter pin	<ul style="list-style-type: none"> Can be used in all areas of the kW ratings table for Lambda Chain. Connecting plates are ring coined.
Super Roller Chain	M-type connecting link Code: MCL	Slip fit (M)	Spring pin	<ul style="list-style-type: none"> Connecting link plates and middle link plates used in multi-strand chain are ring coined.
	F-type connecting link Code: FCL	Press fit	Spring pin	<ul style="list-style-type: none"> Use under extreme conditions (e.g., high shock, very high load, possible side force, etc.). Connecting link plates used in multi-strand chain are not ring-coined. Assemble connecting link plates (press-fit) on the very outside link.
Super-H Chain	F-type connecting link Code: FCL	Press fit (F)	Spring pin	<ul style="list-style-type: none"> Use the Super-H Chain exclusive connecting link plate
Ultra Super Chain	F-type connecting link Code: CL	Press fit (F)	Spring pin	<ul style="list-style-type: none"> Use the Ultra Super Chain exclusive connecting link plate
RS-HT Chain	M-type connecting link Code: MCL	Slip fit (M)	Cotter pin Spring pin	<ul style="list-style-type: none"> Connecting link plates are ring coined. Use exclusive connecting link.
	F-type connecting link Code: FCL	Press fit	Cotter pin Spring pin	<ul style="list-style-type: none"> Use under extreme conditions (e.g. high shock, very high load, possible thrust load, etc.).
Other roller chains in catalog	M-type connecting link Code: CL	Slip fit (M)	Cotter pin, Spring clip Spring pin T-pin, Z-pin	<ul style="list-style-type: none"> Refer to individual dimension diagrams. Only NP, NEP and Low Noise Roller Chains use ring coined connecting link plates.

Note 1. The connecting link plate fastening method for each chain size is indicated in the dimension tables and the table notes.

2. The color of F-type connecting links for RS Roller Chain and RS-HT Roller Chain marked with * is black.

Remark: Ring Coining (RC)

This Tsubaki original processing adds an area of plastic deformation around pin holes to generate residual stress around the holes.



Ring Coining

2.2 Offset Link

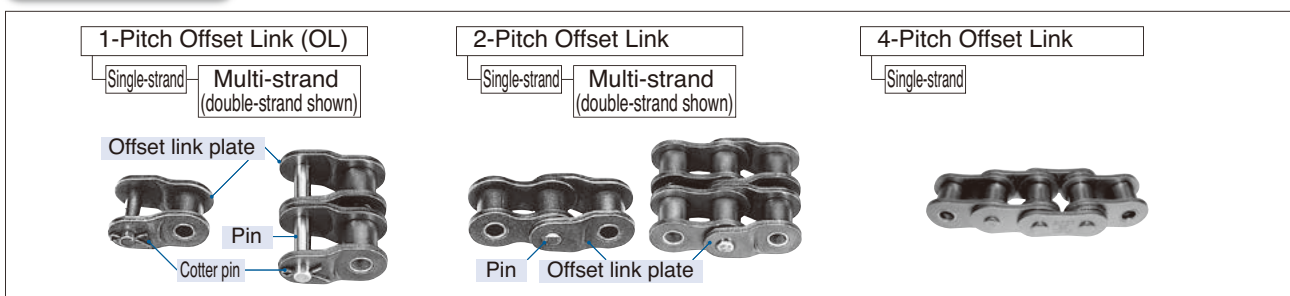

Note : 1. See the dimensional tables for roller chain types and sizes suitable for offset links.

2. Offset links may have lower kW ratings and a lower allowable load than the base chain. See the individual product page for details.

Roller Chain and Specialty Chain Lineup

Series	Product	Features/Applications	Operating temperature range (°C)	Pre-lube Specifications
Standard Roller Chains	RS Roller Chain	JIS-, ISO-compliant	-10 to 60*1	Anti-rust pre-lube
	BS/DIN Standard RS Roller Chain	ISO-compliant series		
Lube-Free Roller Chains	Lambda Chain	Lube-free, long-life (Special oil-impregnated bush)	-10 to 150	Volatile corrosion inhibitor
	Surface Treated Lambda Chain	Lube-free, long-life (Special oil-impregnated bush) Surface treated (NP and NEP)		
	X-Lambda Chain	Super long-life via special oil-impregnated bush and felt seal	-10 to 60	
	Lambda Chain KF Series	Lube-free, long-life (Special oil-impregnated bush), for high temperatures and food processing equipment.	-10 to 230*2	
	Heavy Duty Lambda Chain	Lube-free, long-life (Special oil-impregnated bush), heavy-duty, double-strand only	-10 to 150	
	Curved Lambda Chain	Lube-free, long-life (Special oil-impregnated bush), for curved lines		
BS/DIN Lambda Chain	Lube-free, long-life (Special oil-impregnated bush), ISO-compliant BS Series			
Heavy Duty Roller Chains	Super Chain	High tensile strength (~40% higher than RS Chain)	-10 to 60*1	Anti-rust pre-lube
	RS-HT Chain	High tensile strength (~20% higher than RS Chain)		
	Super-H Chain	High allowable load and tensile strength (~60% higher allowable load and 20% higher tensile strength than RS Chain)		
	Ultra Super Chain	Highest tensile strength of all drive chains		
Corrosion Resistant Roller Chains	Stainless Steel Roller Chain	SS ... High corrosion resistance, high heat resistance	-20 to 400	*3 Not lubed
		NS ... Higher corrosion resistance and higher heat resistance than SS Series		Chain lubricant
		AS ... 1.5x maximum allowable load of SS Series, slightly less corrosion resistance		
		LSC ... Greater wear resistance than SS Series		-20 to 100*4
	Surface Treated Roller Chain	NP ... Low corrosion resistance, special nickel plating	-10 to 60*1	Anti-rust pre-lube
		NEP ... High corrosion resistance		
		APP ... Anti-pitting		
	Titanium Roller Chain	Made of nonmagnetic titanium, high corrosion resistance	-20 to 400	Not lubed
	Cold Resistant Roller Chain	Cold resistance specification	-40 to 60*1	Anti-rust pre-lube
Low Noise Roller Chain	Spring rollers, low noise	-10 to 60*1	Anti-rust pre-lube	
Poly Steel Chain	Corrosion resistance, wear resistance, low noise, lightweight	-20 to 80	Not lubed	
Curved Stainless Steel Roller Chain	Stainless steel, curved transmissions	-20 to 400		
Specialty Roller Chains	Curved Roller Chain	Side-flexing chain, curved transmissions	-10 to 60*1	Anti-rust pre-lube
	Leaf Chain	Plate and pin construction, for lifting applications, AL-type, BL-type (AL ...), (BL ...)		Anti-rust pre-lube

Before Use
 Standard Roller Chains
 Lube-Free Roller Chains
 Heavy Duty Roller Chains
 Corrosion Resistant Roller Chains
 Specialty Roller Chains
 Sprockets
 Pin Gear Drives
 Accessories
 Selection
 Handling



Eco Link Mark

These new products meet our voluntary eco assessment criteria.

Chain No. (Pitch: mm) *2															Ref. page
11 (3.7465)	15 (4.7625)	25 (6.35)	35 (9.525)	40 (12.70)	50 (15.875)	60 (19.05)	80 (25.40)	100 (31.75)	120 (38.10)	140 (44.45)	160 (50.80)	180 (57.15)	200 (63.50)	240 (76.20)	
	●	●	●	●	●	●	●	●	●	●	●	●	●	●	
			RFO6B ●	RSO8B ●	RS10B ●	RS12B ●	RS16B ●	RS20B ●	RS24B ●	RS28B ●	RS32B ●		RS40B ●	RS48B ● ^{*6}	22
				●	●	●	●	●	●	●	●				59
				●	●	●	●	●	●	●					
				●	●	●	●	●	●						
				●	●	●	●	●							
				●	●	●	●	●							
			RFO6B ●	RSO8B ●	RS10B ●	RS12B ●	RS16B ●	RS20B ●	RS24B ●						
							●	●	●	●	●	●	●	●	
						●	●	●	●	●	●		●	●	
							●	●	●	●	●		●	●	
●		●	●	●	●	●	●	●	●	●	●	●	●	●	83
		●	●	●	●	●	●								
				●	●	●	●								
				●	●	●	●								
		●	●	●	●	●	●	●	●	●	●				
			●	●	●	●	●	●	●	●	●	●	●	●	
			●	●	●	●	●	●	●	●	●				
			●	●	●	●	●	●	●	●	●				
		●	●	●	●	●	●								
				●	●	●	●								
				4	5	6	8	10	12	14	16				95
				●	●	●	●	●	●	●	●				

*1: The operating temperature range of pre-lubricated chains (those coated with oil when delivered) is -10 to 60°C (-40 to 60°C for KT specification).

Chain kW ratings do not decrease until 150°C. To use in 60 to 150°C environments, apply a high temperature lubrication. For details and precautions in usage, see "Temperature Selection Method" (page 197) and "Roller Chain Lubrication" (page 202).

*2: Lambda Chain KF Series gives better lubrication performance in high temperature ranges (from ambient temperatures to ~230°C. When using in the 150°C to 230°C range, refer to pg. 197 for temperature selection methods.

*3: RS11-SS-1 comes lubricated.

*4: Operating temperature range when using stainless steel rollers. Operating temperature range for plastic rollers is -20°C to 80°C.

*5: Sizes marked with ● are standard products shown in this catalog. For details, see the corresponding section. Blank cells are specialty items and may be specially ordered. Contact a Tsubaki representative for details.

*6: RS05B (pitch 8.00) and RS56B (pitch 88.9) are also available.

Ordering RS Roller Chain

The following example uses an RS Roller Chain.

Ordering is basically the same for other products, but some products are unavailable. See each section for details.

1. Ordering by Unit

With the exception of special specification chains, RS Roller Chain is normally stocked by unit. The total length of one unit includes one connecting link. Please purchase additional connecting links if you intend to separate the chain into two or more sections or join chains to create a longer chain.

Length of one unit: 3048 mm (10 feet); however
 RS11-SS: 502 mm, RS15: 1000 mm,
 RS25: 1016 mm, RS140: 3023 mm, RS180: 3086 mm.



Ordering example

Ordering n units of RS80-1

Chain no.	Quantity	Unit
RS80-1-RP-U	n	U (unit)

Ordering pieces of RS80-1 CL and OL

Chain no.	Quantity	Unit
RS80-1-CL	n	K (pcs)
RS80-1-OL	n	K (pcs)

Note: When ordering CL, note that there are two types: M-type CL and F-type CL.

- ▶ For M-type CL
Example: RS80-1-CL
- ▶ For F-type CL, write FCL.
Example: RS80-1-FCL

Example:

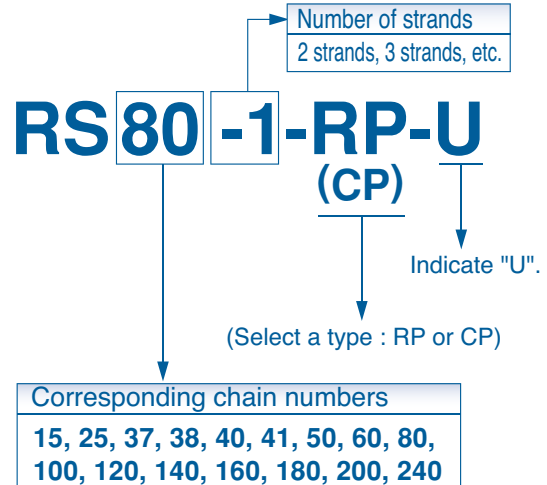

Note: RP (rivet pin) is when the inner plates are connected by the outer plates via riveting.
 CP (cotter pin) is when the inner plates are connected by the outer plates via cotter pins.

2. Ordering Specific Lengths

Chain can be delivered in specified lengths.
 Convert the length of chain you will use into number of chain links when ordering.

Example: When ordering 1,000mm (including connecting link) of RS80-1-RP chain.

$$1,000\text{mm} \div 25.4\text{mm}(\text{chain pitch}) = 39.3\text{links} \Rightarrow \left. \begin{array}{l} \text{RS80-1-RP} \quad 39 \text{ links} \\ \text{RS80-1-CL} \quad \text{One} \end{array} \right\} \text{*Chain total length will be 1,016mm.}$$

2.1 Ordering an Even Number of Links

Be sure to indicate configuration specification.

1 When the number of links is 8



8 links including the connecting link (CL)

Ordering example

Ordering 8 links of RS50-1 Roller Chain

Chain no.	Quantity	Unit
RS50-1-RP	7	L (links)
RS50-1-CL	1	K (pcs)

Indicate the number of links of the chain segment only.
 Example: In the case of 8LX2H, the chain segment is 14L with CL2K
 In the case of 8LX3H, the chain segment is 21L with CL3K

Configuration specification

8LX 1H

Specify the number of strands required.

Note : Be sure to indicate "CL" when you need the part delivered attached to the chain.

2 20-link complete endless



Ordering example

Ordering 20-link complete endless RS50-1-RP

Chain no.	Quantity	Unit
RS50-1-RP	20	L (links)

Configuration specification

20LX 1H (complete endless)

The chain is delivered in an endless loop. Contact a Tsubaki representative for more information.

Specify the number of strands required.

Note : "H" indicates the number of strands.

2.2 Ordering an Odd Number of Links

When ordering an odd number of links with no configuration specified, the chain will be delivered as per **4**. Both ends inner links (RL) below.

1 9 links (with CL and OL)



↑ Connecting link
 ↗ Offset link

Ordering example:

Ordering example: Ordering 9 links of RS50-1-RL (with CL and OL)

Chain no.	Quantity	Unit
RS50-1-RP	7	L (links)
RS50-1-CL	1	K (pcs)
RS50-1-OL	1	K (pcs)

Configuration specification **9Lx1H (CL,OL)**

Note : Be sure to indicate "CL," "OL (2POL)", and so on when you need the part delivered attached to the chain.

2 9 links (when specifying 2POL)



↗ 2 pitch offset link
 ↑ Connecting link

Chain no.	Quantity	Unit
RS50-1-RP	5	L (links)
RS50-1-CL	2	K (pcs)
RS50-1-2POL	1	K (pcs)

Configuration specification **9Lx1H (2POL,CL)**

Note : Be sure to indicate "CL," "OL (2POL)", and so on when you need the part delivered attached to the chain.

Ordering RS Roller Chain

The ordering examples shown in the photos have CL, OL, and PL included for convenience. On an actual order the CL, OL, and PL will be delivered not assembled onto the chain. You will need to indicate assembly in the configuration if necessary.

3 9 links (with connecting links on both ends)



Chain no.	Quantity	Unit
RS50-1-RP	7	L (links)
RS50-1-CL	2	K (pcs)

Configuration specification **9Lx1H (CL-CL)**

Note : Be sure to indicate "CL" when you need the part delivered attached to the chain.

4 9 links (both ends inner links)



Chain no.	Quantity	Unit
RS50-1-RP	9	L (links)

Configuration specification **9Lx1H (RL-RL)**

5 9 links (both ends outer links)

*Not available for RP type chains

Chain no.	Quantity	Unit
RS120-1-CP	9	L (links)

Configuration specification **9Lx1H (PL-PL)**

3. Matched and Tagged Chain

Deviations in chain length exist due to the manufacturing tolerances of the parts. When chains are to be used in parallel and minimizing the relative difference in the lengths is necessary, request a "matched and tagged" chain.

Note: A separate charge is required for a length matching.

Example entry in special mention column

For example, if you need three sets of two single-strand, 120-link RS80 chains, the entry should be:

RS80-1-RP 720 links

Matched and tagged chain: 120 L x 2 H x 3 D

4. Reel Chain

Single-strand RS25 to RS80 chain (see table below) is available on long-length reels.

Ordering example

Ordering one reel of RS50-1-RP Roller Chain

Chain no.	Quantity	Unit
RS50-1-RP-10UR	1	R

Chain no.	No. of units per reel	No. of links (unit: L)	No. of CL provided (M-type connecting links)
RS25-1-RP-150UR	150	23999	150
RS35-1-RP-20UR	20	6399	20
RS37-1-RP-20UR	20	4799	20
RS38-1-RP-20UR	20	4799	20
RS41-1-RP-20UR	20	4799	20
RS40-1-RP-15UR	15	3599	15
RS50-1-RP-10UR	10	1919	10
RS60-1-RP-10UR	10	1599	10
RS80-1-RP-5UR	5	599	5

Note : Stock item. No other configurations available.

5. Long Length Formation / Super Long Length Formation

1 Long length formation

Chains whose total length exceeds one unit (3048mm) are called long length formations. Chains that exceed the lengths below are super long length formations and are delivered connected in special boxes. Additional fees apply.

	RS25	RS35 – RS180	RS200	RS240
Single strand	3 units	2.5 units	100 links (~6.3m)	70 links (~5.3m)
Multi-strand	Contact a Tsubaki representative			

2 Super long length formations

Super long length formations are longer than the long length formations listed above. Chains up to the maximum length shown in the tables below will be delivered connected in special wooden boxes. See pg. 101 regarding how leaf chains will be packaged. (Contact a Tsubaki representative regarding chains longer than the maximum lengths shown below.)

Size	No. of strands	Chain pitch mm	Chain mass kg/m	Maximum length	
				m	No. of links
RS120	1	38.1	5.93	76.8	2016
RS120	2		11.70	76.8	2016
RS120	3		17.53	51.3	1346
RS140	1	44.45	7.49	64.0	1440
RS140	2		14.83	60.7	1364
RS140	3		22.20	40.5	910
RS160	1	50.8	10.10	57.6	1134
RS160	2		20.04	44.9	882
RS160	3		30.02	30.0	590
RS180	1	57.15	13.45	50.7	888
RS180	2		26.52	33.9	592
RS180	3		38.22	23.5	410
RS200	1	63.5	16.49	46.1	726
RS200	2		32.63	27.6	434
RS200	3		49.02	18.4	288
RS240	1	76.2	24.50	36.3	476
RS240	2		48.10	18.7	244
RS240	3		71.60	12.6	164
RS24B	1	38.1	7.45	78.9	2072
RS24B	2		14.65	61.4	1610
RS24B	3		21.75	41.4	1086
RS28B	1	44.45	9.45	74.7	1680
RS28B	2		18.80	47.9	1076
RS28B	3		28.20	31.9	716
RS32B	1	50.8	10.25	61.9	1218
RS32B	2		20.10	44.8	880
RS32B	3		29.90	30.1	592
RS40B	1	63.5	16.35	48.1	758
RS40B	2		32.00	28.1	442
RS40B	3		47.75	18.8	296
RS48B	1	76.2	29.50	30.5	400
RS48B	2		58.10	15.5	202
RS48B	3		86.20	10.4	136
RS56B	1	88.9	33.60	26.8	300
RS56B	2		66.20	13.6	152
RS56B	3		98.10	9.2	102

Note : 1. There are separate fees for connecting the chain and the wooden box. Contact a Tsubaki representative for more information.
2. There are separate fees for matching and tagging and minimizing differences in total length.

■ For Your Safety

- Because the chain will be a long length formation, be sure to confirm the chain mass and use a sufficiently strong hoist and jig when lifting.
- When removing the chain from the special wooden box, ensure that the box opening faces up when standing the box up. Take care that the standing box does not tip over.
- When removing the chain from the special wooden box, ensure that the box opening faces up when attaching the chain end to the hoist jig. Pull the chain from the box after ensuring there is no danger of the chain falling.

6. Replacement Precautions

When you do not know the roller chain number

1

Verification of the roller chain specifications (strength type, material, etc.) is important. Check with the manufacturer.

2

Check the roller chain size and specifications that are engraved on the roller chain plate.

3

Measure the pitch, roller diameter, inner width of inner link, and plate thickness of the roller chain.

Selecting RS Sprockets

The RS sprocket model is determined by the following six elements.

When selecting your sprocket, carefully examine the model and usage conditions of the chain that you will be using and select the optimal sprocket.

1. Chain used

RS sprockets are manufactured with a tooth profile and dimensional precision to bring out the maximum performance of the chain you will use.

2. Number of teeth

RS sprockets are available with small and large numbers of teeth to match your usage conditions.

3. Construction

RS sprockets are manufactured in four types in conformance with JIS standards.

Model code	A Type (flat plate)	B Type (single side hub)	C Type (dual side hub)	SD Type (single dual)
Construction				
		Multi-strand Heavy Duty Chain (Super-H, RS-HT, etc.)		For using two single strand chains at the same time
		HB Type	HC Type	

4. Material

RS sprockets are available in the following material as standard.

	Material
Carbon steel	Carbon steel for machine structural use or rolled steel for general structural use
Stainless steel	Austenitic stainless steel
Plastic	Engineering plastic
Sintered alloy	Ferrous sintered alloy (used for some RS25 sprockets)

5. Tooth profile

	Specifications
Hardened teeth	Use sprockets with hardened teeth when tooth strength and wear resistance need to be increased. All Strong Type and TOUGH TOOTH sprockets use hardened teeth.
Non-heat treated	Teeth are not hardened. The teeth on RS sprockets in the large tooth range are not heat treated

6. Bore

The following three types of bores for attaching the sprocket to a shaft are available for RS sprockets.

Series	Appearance	Specifications
Standard pilot bore		You will need to further finish the bore when using.
Fit Bore		Uses a code for the type of bore finishing. Allows for accurate ordering with just the model number. Quick delivery available.
Lock Sprocket		Tightening a bolt firmly locks the sprocket to the shaft by means of frictional force from the taper sleeve. Can be attached simply with no troublesome keyway processing on the shaft side for easy phase matching. Removal is also easy.

RS15

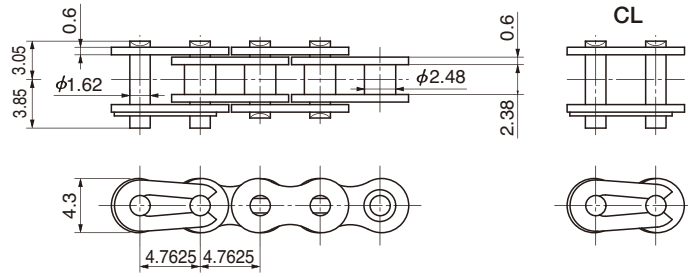

TSUBAKI Chain Number	Minimum Tensile Strength kN{kgf}	Average Tensile Strength kN{kgf}	Maximum Allowable Load kN{kgf}	Approximate Mass g/m	Number of Links Per Unit
RS15-1-RP	1.77{180}	2.26{230}	0.31{32}	75	210
RS15-1-RP-U					

- Note: 1. No offset links available.
 2. Bushed chain.
 3. Stocked in units.
 4. The dimensions shown in this catalog are nominal dimensions and differ from actual dimensions.

*The maximum allowable load when using an M-type connecting link is 0.25kN.

RS15 Sprocket

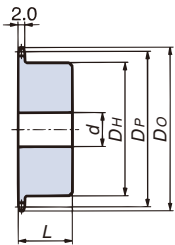

Mechanically machined 1B type

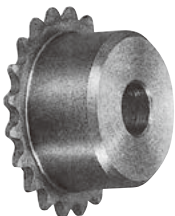

Number of Teeth	Pitch Circular Diameter (DP)	Sprocket Outer Diameter (DO)	Bore Diameter (d)		Hub		Approximate Weight (g)	Material
			Pilot Bore Diameter	Maximum	Diameter (DH)	Length (L)		
11	16.90	19.0	4	7	11	10	9	Machine-structural carbon steel
12	18.40	20.5	4	8	12	10	10	
13	19.90	22.0	4	9	14	10	14	
14	21.40	23.5	6	10	15	12	17	
15	22.91	25.0	6	12	17	12	22	
16	24.41	26.5	8	12	18	12	23	
17	25.92	28.0	8	14	20	14	32	
18	27.43	29.5	8	14	22	14	40	
19	28.93	31.0	8	15	23	14	44	
20	30.44	32.5	8	15	24	14	49	
21	31.95	34.0	8	17	26	14	57	
22	33.46	35.5	8	17	27	14	62	
23	34.98	37.5	8	17	28	14	68	
24	36.49	39.0	8	20	30	16	88	
25	38.00	40.5	8	20	32	16	100	
26	39.51	42.0	10	22	33	16	104	
27	41.02	43.5	10	25	35	16	117	
28	42.54	45.0	10	25	37	16	131	
29	44.05	46.5	10	25	38	16	139	
30	45.56	48.0	10	25	39	16	147	
31	47.08	49.5	10	25	40	18	175	
32	48.59	51.0	10	25	40	18	176	
33	50.10	52.5	10	25	40	18	178	
34	51.62	54.0	10	25	40	18	180	
35	53.13	55.5	10	25	40	18	182	

- Note: 1. Bore diameter noted above is the typical range. Determine bore diameter and key bearing pressure based on general mechanical design.
 2. Pilot bore diameters are finished to an H10 tolerance.
 3. All models stocked.
 4. The dimensions shown in this catalog are nominal dimensions and differ from actual dimensions.

Model numbering

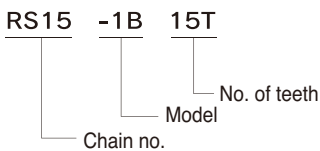

RS25, BF25-H-1

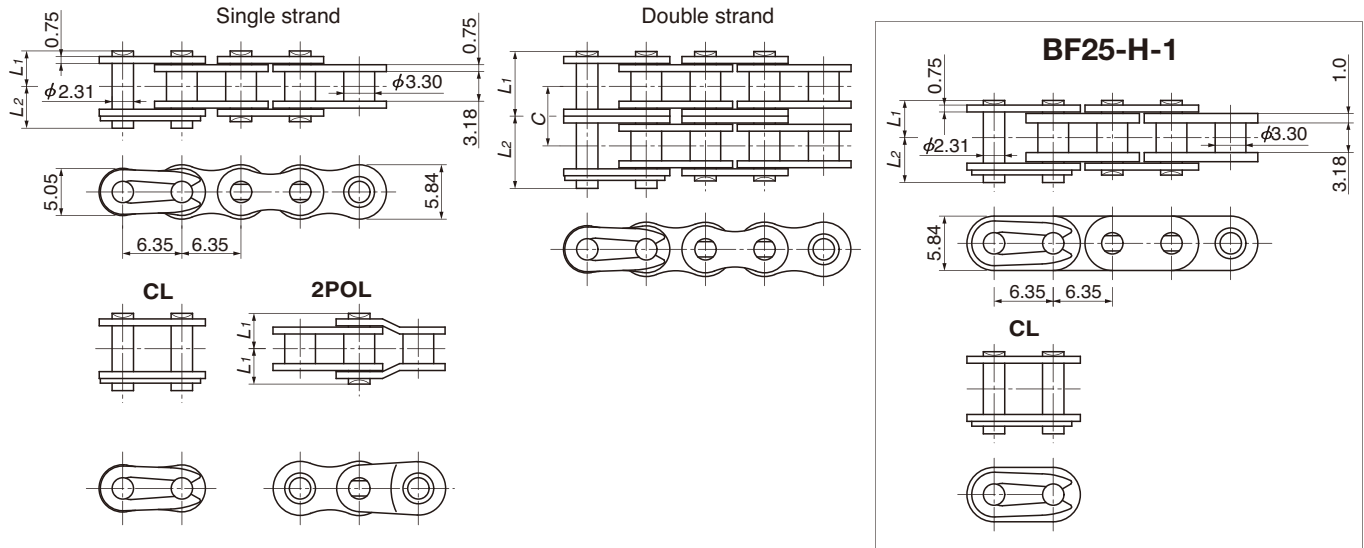

TSUBAKI Chain Number	Number of Strands	Pin Length L ₁ +L ₂	Dimensions L ₁	Dimensions L ₂	Transverse Pitch C	Pin Type	ANSI Standard Min. Tensile Strength kN{kgf}	Tsubaki Minimum Tensile Strength kN{kgf}	Tsubaki Average Tensile Strength kN{kgf}	Maximum Allowable Load kN{kgf}	Approximate Mass kg/m
RS25-1	1	8.3	3.8	4.5	—	Riveting	3.5 {357}	4.12 {420}	4.71 {480}	0.64 {65}	0.14
RS25-2	2	14.7	7.0	7.7	6.4		7.0 {714}	8.24 {840}	9.41 {960}	1.08{110}	0.27
RS25-3	3	21.1	10.2	10.9	6.4		10.5{1071}	12.4{1260}	14.1{1440}	1.57{160}	0.42
BF25-H-1	1	8.82	4.01	4.81	—		—	4.9 {500}	5.88 {600}	0.78 {80}	0.17

Note: 1. Offset links for RS25 only available in two pitch offset links. The maximum allowable load is the same as shown in the table above.

Minimum tensile strength for 2POL for RS25-1 is 3.82kN, 7.65kN for RS25-2, and 11.5kN for RS25.3.

- No offset links are available for BF25-H-1.
- One unit has 160 links.
- Both RS25 and BF25-H-1 are bushed chains.
- Stocked in units.
- The dimensions shown in this catalog are nominal dimensions and differ from actual dimensions.
- *Maximum allowable load when using an M-type connecting link is 80% of the above.

■ RS25-1 Maximum Kilowatt Ratings Table (kW Ratings for Single Strand Chain)

Lubrication Type Small Sprocket No. of Teeth	Small Sprocket Max rpm																								
	50	100	300	500	700	900	1200	1500	1800	2100	2500	3000	3500	4000	4500	5000	5500	6000	6500	7000	7500	8000	8500	9000	10000
9	0.02	0.03	0.08	0.13	0.18	0.23	0.30	0.36	0.43	0.49	0.57	0.67	0.78	0.76	0.64	0.55	0.47	0.41	0.37	0.33	0.30	0.27	0.25	0.23	0.19
10	0.02	0.04	0.10	0.15	0.20	0.26	0.33	0.41	0.48	0.55	0.64	0.76	0.87	0.89	0.75	0.64	0.55	0.49	0.43	0.39	0.35	0.32	0.29	0.26	0.23
11	0.02	0.04	0.11	0.17	0.23	0.28	0.37	0.45	0.53	0.61	0.71	0.84	0.96	1.03	0.86	0.74	0.64	0.56	0.50	0.44	0.40	0.36	0.33	0.30	0.26
12	0.02	0.04	0.12	0.18	0.25	0.31	0.40	0.49	0.58	0.67	0.78	0.92	1.06	1.17	0.98	0.84	0.73	0.64	0.57	0.51	0.46	0.41	0.38	0.35	0.30
13	0.03	0.05	0.13	0.20	0.27	0.34	0.44	0.54	0.63	0.73	0.85	1.00	1.15	1.30	1.11	0.95	0.82	0.72	0.64	0.57	0.52	0.47	0.43	0.39	0.33
14	0.03	0.05	0.14	0.22	0.29	0.37	0.48	0.58	0.69	0.79	0.92	1.09	1.25	1.41	1.24	1.06	0.92	0.80	0.71	0.64	0.58	0.52	0.48	0.44	0.37
15	0.03	0.05	0.15	0.23	0.32	0.40	0.51	0.63	0.74	0.85	0.99	1.17	1.35	1.52	1.37	1.17	1.02	0.89	0.79	0.71	0.64	0.58	0.53	0.49	0.41
16	0.03	0.06	0.16	0.25	0.34	0.43	0.55	0.67	0.79	0.91	1.07	1.26	1.44	1.63	1.51	1.29	1.12	0.98	0.87	0.78	0.70	0.64	0.58	0.54	0.46
17	0.03	0.06	0.17	0.27	0.36	0.45	0.59	0.72	0.85	0.97	1.14	1.34	1.54	1.74	1.66	1.42	1.23	1.08	0.95	0.85	0.77	0.70	0.64	0.59	0.50
18	0.04	0.07	0.18	0.28	0.39	0.48	0.63	0.76	0.90	1.04	1.21	1.43	1.64	1.85	1.81	1.54	1.34	1.17	1.04	0.93	0.84	0.76	0.70	0.64	0.55
19	0.04	0.07	0.19	0.30	0.41	0.51	0.66	0.81	0.96	1.10	1.28	1.51	1.74	1.96	1.96	1.67	1.45	1.27	1.13	1.01	0.91	0.83	0.75	0.69	0.59
20	0.04	0.07	0.20	0.32	0.43	0.54	0.70	0.86	1.01	1.16	1.36	1.60	1.84	2.07	2.11	1.81	1.57	1.37	1.22	1.09	0.98	0.89	0.81	0.75	0.64
21	0.04	0.08	0.21	0.34	0.45	0.57	0.74	0.90	1.06	1.22	1.43	1.69	1.94	2.18	2.28	1.94	1.68	1.48	1.31	1.17	1.06	0.96	0.88	0.80	0.69
22	0.04	0.08	0.22	0.35	0.48	0.60	0.78	0.95	1.12	1.29	1.50	1.77	2.04	2.30	2.44	2.08	1.81	1.58	1.41	1.26	1.13	1.03	0.94	0.86	0.74
23	0.05	0.09	0.23	0.37	0.50	0.63	0.82	1.00	1.17	1.35	1.58	1.86	2.14	2.41	2.61	2.23	1.93	1.69	1.50	1.34	1.21	1.10	1.00	0.92	0.79
24	0.05	0.09	0.25	0.39	0.53	0.66	0.85	1.04	1.23	1.41	1.65	1.95	2.24	2.52	2.78	2.37	2.06	1.81	1.60	1.43	1.29	1.17	1.07	0.98	0.84
25	0.05	0.10	0.26	0.41	0.55	0.69	0.89	1.09	1.28	1.48	1.73	2.03	2.34	2.64	2.93	2.52	2.19	1.92	1.70	1.52	1.37	1.25	1.14	1.04	0.89
26	0.05	0.10	0.27	0.42	0.57	0.72	0.93	1.14	1.34	1.54	1.80	2.12	2.44	2.75	3.06	2.68	2.32	2.04	1.81	1.62	1.46	1.32	1.21	1.11	0.95
28	0.06	0.11	0.29	0.46	0.62	0.78	1.01	1.23	1.45	1.67	1.95	2.30	2.64	2.98	3.31	2.99	2.59	2.28	2.02	1.81	1.63	1.48	1.35	1.24	1.06
30	0.06	0.12	0.31	0.49	0.67	0.84	1.09	1.33	1.56	1.80	2.10	2.48	2.85	3.21	3.57	3.32	2.88	2.52	2.24	2.00	1.81	1.64	1.50	1.37	1.17
32	0.07	0.12	0.33	0.53	0.72	0.90	1.16	1.42	1.68	1.93	2.25	2.66	3.05	3.44	3.83	3.65	3.17	2.78	2.47	2.21	1.99	1.81	1.65	1.51	1.29
35	0.07	0.14	0.37	0.58	0.79	0.99	1.28	1.57	1.85	2.12	2.48	2.93	3.36	3.79	4.21	4.18	3.62	3.18	2.82	2.52	2.28	2.07	1.89	1.73	1.48
40	0.08	0.16	0.43	0.67	0.91	1.14	1.48	1.81	2.13	2.45	2.87	3.38	3.88	4.38	4.87	5.11	4.43	3.89	3.45	3.08	2.78	2.52	2.30	2.11	1.81
45	0.10	0.18	0.48	0.77	1.04	1.30	1.68	2.06	2.42	2.78	3.26	3.84	4.41	4.97	5.53	6.08	5.28	4.64	4.11	3.68	3.32	3.01	2.75	2.52	2.15

Note: 1. Please contact a Tsubaki representative prior to use of kW ratings in the colored area of the table.

Multi-strand factor	Number of chain strands	Multi-strand factor
	Double strand	1.7
	Triple strand	2.5

Lubrication method	A	Manual lubrication or drip lubrication	Details on Pg. 202
	B	Oil bath or slinger disc lubrication	
	C	Forced pump lubrication	

RS25, BF25-H Sprocket

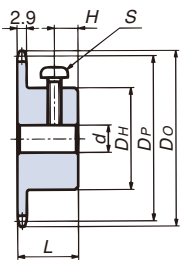

Note:
 1. Bores are finished and fitted with a screw.
 2. All models stocked.
 3. The dimensions shown in this catalog are nominal dimensions and differ from actual dimensions.

Model numbering

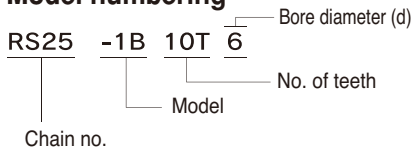

Number of Teeth	Pitch Circular Diameter (D _P)	Sprocket Outer Diameter (D _O)	Bore Diameter (d)	Hub		Cross-recessed Head Machine Screw		Approx. Mass (g)	Material	
				Diameter (D _H)	Length (L)	Position (H)	S			
10	20.55	23.5	6 · 8	13	14	4	M3X6	13	Sintered alloy	
11	22.54	25.5	6 · 8	15	14	4	M3X8	16		
12	24.53	27.5	8 · 10	17	14	4	M4X8	20		
13	26.53	29.5	8 · 10	18	14	4	M4X8	23		
14	28.54	31.5	8 · 10	19	14	4	M4X8	26		
15	30.54	33.5	8 · 10	20	14	4	M4X10	31		
16	32.55	35.5	8 · 10	21	16	5	M4X10	38		
17	34.56	37.5	8 · 10	23	16	5	M4X10	45		
18	36.57	39.5	8 · 10	25	16	5	M4X12	52		
19	38.58	41.5	8 · 10	26	16	5	M4X12	60		
20	40.59	43.5	8 · 10	28	16	5	M4X14	68		Machine-structural carbon steel
21	42.61	45.5	8 · 10	30	18	7	M4X14	80		
22	44.62	48.0	8 · 10	30	18	7	M4X14	84		
23	46.63	50.0	8 · 10	30	18	7	M4X14	88		
24	48.65	52.0	8 · 10	30	18	7	M4X14	93		
25	50.66	54.0	8 · 10	30	18	7	M4X14	98		
26	52.68	56.0	10 · 12	30	18	7	M4X14	98		
28	56.71	60.0	10 · 12	30	18	7	M4X14	103		
30	60.75	64.0	10 · 12	30	18	7	M4X14	110		
32	64.78	68.0	10 · 12	30	18	7	M4X14	117		

RS37-1, RS38-1, RS41-1

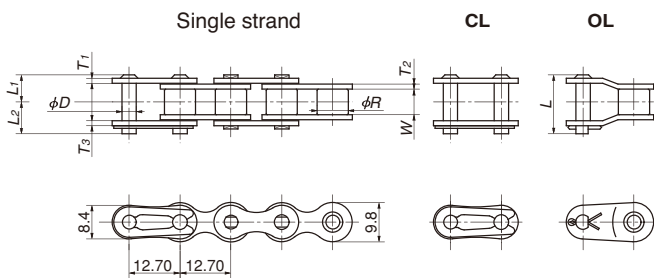

TSUBAKI Chain Number	Pitch P	Roller Diameter R	Inner Width of Inner Link W	Plates			Pins				
				T ₁	T ₂	T ₃	D	L ₁ +L ₂	L ₁	L ₂	L
RS37-1	12.70	7.80	3.40	1.0	1.0	1.2	3.63	11.0	5.1	5.9	12.45
RS38-1	12.70	7.80	4.80	1.1	1.1	1.2	3.63	13.1	6.0	7.1	14.1
RS41-1	12.70	7.77	6.38	1.25	1.25	1.25	3.59	14.7	6.75	7.95	15.1

TSUBAKI Chain Number	ANSI Standard Min. Tensile Strength kN{kgf}	Tsubaki Minimum Tensile Strength kN{kgf}	Tsubaki Average Tensile Strength kN{kgf}	Maximum Allowable Load kN{kgf}	Approximate Mass kg/m	Number of Links Per Unit
RS37-1	-	8.14{830}	9.41{960}	1.37{140}	0.29	240
RS38-1	-	8.14{830}	9.41{960}	1.37{140}	0.35	240
RS41-1	6.7{684}	10.3{1050}	11.8{1200}	2.26{230}	0.41	240

Note:
 1. Stocked in units.
 2. The dimensions shown in this catalog are nominal dimensions and differ from actual dimensions.

*Maximum allowable load when using an M type connecting link is 80% of the above.

■ RS41-1 Maximum Kilowatt Ratings Table (kW Ratings for Single Strand Chain)

Small Sprocket No. of Teeth	Small Sprocket Max rpm																											
	10	25	50	100	200	300	400	500	700	900	1000	1200	1400	1600	1800	2100	2400	2700	3000	3500	4000	5000	6000	7000	8000			
9	0.02	0.05	0.10	0.18	0.34	0.49	0.64	0.78	1.05	1.32	1.24	0.95	0.75	0.61	0.52	0.41	0.33	0.28	0.24	0.19	0.16	0.11	0.08	0.07	0.05			
10	0.03	0.06	0.11	0.20	0.38	0.55	0.71	0.87	1.18	1.48	1.46	1.11	0.88	0.72	0.60	0.48	0.39	0.33	0.28	0.22	0.18	0.13	0.10	0.08	0.06			
11	0.03	0.07	0.12	0.23	0.42	0.61	0.79	0.96	1.31	1.64	1.68	1.28	1.01	0.83	0.70	0.55	0.45	0.38	0.32	0.26	0.21	0.15	0.11	0.09	0.07			
12	0.03	0.07	0.13	0.25	0.46	0.67	0.87	1.06	1.43	1.80	1.91	1.46	1.16	0.95	0.79	0.63	0.52	0.43	0.37	0.29	0.24	0.17	0.13	0.10	0.08			
13	0.03	0.08	0.15	0.27	0.51	0.73	0.95	1.16	1.56	1.96	2.16	1.64	1.30	1.07	0.89	0.71	0.58	0.49	0.42	0.33	0.27	0.19	0.15	0.12	0.10			
14	0.04	0.08	0.16	0.29	0.55	0.79	1.02	1.25	1.69	2.12	2.34	1.84	1.46	1.19	1.00	0.79	0.65	0.54	0.46	0.37	0.30	0.22	0.16	0.13	0.11			
15	0.04	0.09	0.17	0.32	0.59	0.85	1.10	1.35	1.83	2.29	2.52	2.04	1.62	1.32	1.11	0.88	0.72	0.60	0.52	0.41	0.33	0.24	0.18	0.14	0.12			
16	0.04	0.10	0.18	0.34	0.63	0.91	1.18	1.45	1.96	2.45	2.70	2.24	1.78	1.46	1.22	0.97	0.79	0.66	0.57	0.45	0.37	0.26	0.20	0.16	0.13			
17	0.05	0.10	0.19	0.36	0.68	0.97	1.26	1.54	2.09	2.62	2.88	2.26	1.95	1.60	1.34	1.06	0.87	0.73	0.62	0.49	0.40	0.29	0.22	0.17	0.14			
18	0.05	0.11	0.21	0.39	0.72	1.04	1.34	1.64	2.22	2.79	3.06	2.68	2.12	1.74	1.46	1.16	0.95	0.79	0.68	0.54	0.44	0.31	0.24	0.19				
19	0.05	0.12	0.22	0.41	0.76	1.10	1.42	1.74	2.36	2.95	3.25	2.90	2.30	1.89	1.58	1.25	1.03	0.86	0.73	0.58	0.48	0.34	0.26	0.21				
20	0.05	0.12	0.23	0.43	0.81	1.16	1.51	1.84	2.49	3.12	3.43	3.13	2.49	2.04	1.71	1.35	1.11	0.93	0.79	0.63	0.52	0.37	0.28	0.22				
21	0.06	0.13	0.24	0.46	0.85	1.22	1.59	1.94	2.63	3.29	3.62	3.37	2.68	2.19	1.84	1.46	1.19	1.00	0.85	0.68	0.55	0.40	0.30	0.24				
22	0.06	0.14	0.26	0.48	0.89	1.29	1.67	2.04	2.76	3.46	3.81	3.62	2.87	2.35	1.97	1.56	1.28	1.07	0.91	0.73	0.59	0.43	0.32	0.26				
23	0.06	0.14	0.27	0.50	0.94	1.35	1.75	2.14	2.90	3.63	3.99	3.87	3.07	2.51	2.10	1.67	1.37	1.15	0.98	0.78	0.64	0.45	0.35	0.27				
24	0.07	0.15	0.28	0.53	0.98	1.41	1.83	2.24	3.03	3.80	4.18	4.12	3.27	2.68	2.24	1.78	1.46	1.22	1.04	0.83	0.68	0.48	0.37	0.29				
25	0.07	0.16	0.29	0.55	1.03	1.48	1.92	2.34	3.17	3.97	4.37	4.38	3.48	2.85	2.38	1.89	1.55	1.30	1.11	0.88	0.72	0.52	0.39					
26	0.07	0.16	0.31	0.57	1.07	1.54	2.00	2.44	3.31	4.15	4.56	4.65	3.69	3.02	2.53	2.01	1.64	1.38	1.18	0.93	0.76	0.55	0.42					
28	0.08	0.18	0.33	0.62	1.16	1.67	2.16	2.65	3.58	4.49	4.94	5.19	4.12	3.37	2.83	2.24	1.84	1.54	1.31	1.04	0.85	0.61	0.46					
30	0.08	0.19	0.36	0.67	1.25	1.80	2.33	2.85	3.86	4.84	5.32	5.76	4.57	3.74	3.13	2.49	2.04	1.71	1.46	1.16	0.95	0.68	0.52					
32	0.09	0.21	0.38	0.72	1.34	1.93	2.50	3.06	4.14	5.19	5.70	6.34	5.03	4.12	3.45	2.74	2.24	1.88	1.60	1.27	1.04	0.75						
35	0.10	0.23	0.42	0.79	1.48	2.13	2.75	3.37	4.56	5.72	6.28	7.26	5.76	4.71	3.95	3.13	2.57	2.15	1.84	1.46	1.19	0.85						
40	0.12	0.26	0.49	0.91	1.71	2.46	3.18	3.89	5.27	6.60	7.26	8.55	7.04	5.76	4.83	3.83	3.13	2.63	2.24	1.78	1.46	1.04						
45	0.13	0.30	0.56	1.04	1.94	2.79	3.61	4.42	5.98	7.50	8.24	9.71	8.39	6.87	5.76	4.57	3.74	3.13	2.68	2.12	1.74							

Note: 1. Please contact a Tsubaki representative prior to use of kW ratings in the colored area of the table.

Lubrication method	A	Manual lubrication or drip lubrication	Details on Pg. 202
	B	Oil bath or slinger disc lubrication	
	C	Forced pump lubrication	

RS35

Single strand

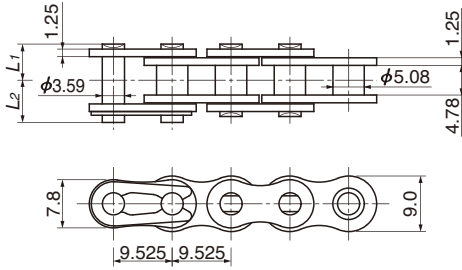

Double strand

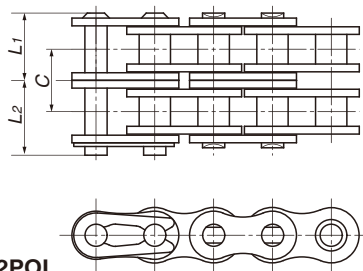

Triple strand

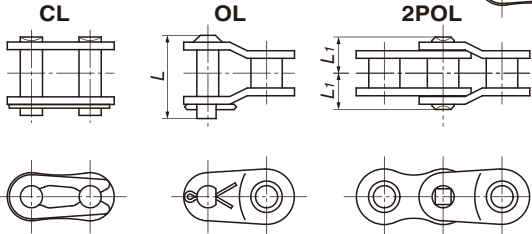
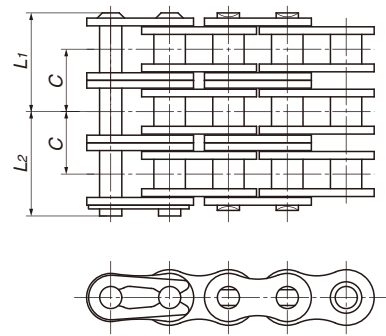

Both ends of pins for offset links for multi-strand chain use cotter pins.

TSUBAKI Chain Number	Number of Strands	Pin Length L ₁ +L ₂	Dimensions L ₁	Dimensions L ₂	Offset Pin Length L	Transverse Pitch C	Pin Type	ANSI Standard Min. Tensile Strength kN{kgf}	Tsubaki Minimum Tensile Strength kN{kgf}	Tsubaki Average Tensile Strength kN{kgf}	Maximum Allowable Load kN{kgf}	Approximate Mass kg/m
RS35-1	1	12.7	5.85	6.85	13.5		Riveting	7.9 {806}	9.81{1000}	11.3{1150}	2.16{220}	0.33
RS35-2	2	22.8	10.9	11.9	24.5	10.1		15.8{1612}	19.6{2000}	22.6{2300}	3.63{370}	0.69
RS35-3	3	32.9	16.0	16.9	34.6			23.7{2417}	29.4{3000}	33.8{3450}	5.39{550}	1.05

- Note: 1. Maximum allowable load when using a one-pitch offset link (OL) is 65% of the above.
 2. Number of links per unit = 320
 3. Bushed chain.
 4. Stocked in units.
 5. The dimensions shown in this catalog are nominal dimensions and differ from actual dimensions.

■ RS35-1 Maximum Kilowatt Ratings Table (kW Ratings for Single Strand Chain)

Small Sprocket No. of Teeth	Small Sprocket Max rpm																								
	A										B										C				
	50	100	300	500	700	900	1200	1500	1800	2100	2500	3000	3500	4000	4500	5000	5500	6000	6500	7000	7500	8000	8500	9000	10000
9	0.09	0.17	0.47	0.74	1.00	1.26	1.63	1.99	2.34	2.69	2.13	1.62	1.29	1.05	0.88	0.75	0.65	0.57	0.51	0.46	0.41	0.37	0.34	0.31	0.27
10	0.10	0.19	0.52	0.83	1.12	1.41	1.82	2.23	2.63	3.02	2.50	1.90	1.51	1.23	1.03	0.88	0.77	0.67	0.60	0.53	0.48	0.44	0.40	0.37	0.31
11	0.12	0.22	0.58	0.92	1.24	1.56	2.02	2.47	2.91	3.34	2.88	2.19	1.74	1.42	1.19	1.02	0.88	0.77	0.69	0.61	0.55	0.50	0.46	0.42	0.36
12	0.13	0.24	0.64	1.01	1.37	1.71	2.22	2.71	3.20	3.67	3.28	2.50	1.98	1.62	1.36	1.16	1.01	0.88	0.78	0.70	0.63	0.57	0.52	0.48	0.41
13	0.14	0.26	0.70	1.10	1.49	1.87	2.42	2.96	3.49	4.01	3.70	2.82	2.23	1.83	1.53	1.31	1.13	1.00	0.88	0.79	0.71	0.65	0.59	0.54	0.46
14	0.15	0.28	0.75	1.19	1.61	2.02	2.62	3.21	3.78	4.34	4.14	3.15	2.50	2.04	1.71	1.46	1.27	1.11	0.99	0.88	0.80	0.72	0.66	0.61	0.52
15	0.16	0.30	0.81	1.29	1.74	2.18	2.83	3.45	4.07	4.68	4.59	3.49	2.77	2.27	1.90	1.62	1.41	1.23	1.09	0.98	0.88	0.80	0.73	0.67	0.57
16	0.17	0.32	0.87	1.38	1.87	2.34	3.03	3.70	4.36	5.01	5.05	3.85	3.05	2.5	2.09	1.79	1.55	1.36	1.21	1.08	0.97	0.88	0.81	0.74	0.63
17	0.19	0.35	0.93	1.47	1.99	2.50	3.23	3.95	4.66	5.35	5.54	4.21	3.34	2.74	2.29	1.96	1.70	1.49	1.32	1.18	1.07	0.97	0.88	0.81	0.69
18	0.20	0.37	0.99	1.56	2.12	2.66	3.44	4.21	4.96	5.69	6.03	4.59	3.64	2.98	2.50	2.13	1.85	1.62	1.44	1.29	1.16	1.05	0.96	0.88	0.75
19	0.21	0.39	1.05	1.66	2.25	2.82	3.65	4.46	5.25	6.04	6.54	4.98	3.95	3.23	2.71	2.31	2.00	1.76	1.56	1.40	1.26	1.14	1.04	0.96	0.82
20	0.22	0.41	1.11	1.75	2.37	2.98	3.86	4.71	5.55	6.38	7.06	5.37	4.26	3.49	2.93	2.50	2.16	1.90	1.69	1.51	1.36	1.23	1.13	1.03	0.88
21	0.23	0.43	1.17	1.85	2.5	3.14	4.06	4.97	5.85	6.72	7.6	5.78	4.59	3.76	3.15	2.69	2.33	2.04	1.81	1.62	1.46	1.33	1.21	1.11	0.95
22	0.24	0.46	1.23	1.94	2.63	3.30	4.27	5.22	6.16	7.07	8.15	6.20	4.92	4.03	3.37	2.88	2.50	2.19	1.94	1.74	1.57	1.42	1.30	1.19	1.02
23	0.26	0.48	1.29	2.04	2.76	3.46	4.48	5.48	6.46	7.42	8.68	6.63	5.26	4.30	3.61	3.08	2.67	2.34	2.08	1.86	1.68	1.52	1.39	1.28	1.09
24	0.27	0.50	1.35	2.13	2.89	3.62	4.69	5.74	6.76	7.77	9.09	7.06	5.61	4.59	3.85	3.28	2.85	2.50	2.21	1.98	1.79	1.62	1.48	1.36	1.16
25	0.28	0.52	1.41	2.23	3.02	3.79	4.91	6.00	7.07	8.12	9.50	7.51	5.96	4.88	4.09	3.49	3.03	2.66	2.35	2.11	1.90	1.72	1.57	1.45	1.23
26	0.29	0.55	1.47	2.33	3.15	3.95	5.12	6.26	7.37	8.47	9.91	7.97	6.32	5.17	4.34	3.70	3.21	2.82	2.50	2.23	2.02	1.83	1.67	1.53	1.31
28	0.32	0.59	1.59	2.52	3.41	4.28	5.54	6.78	7.99	9.18	10.7	8.90	7.06	5.78	4.85	4.14	3.59	3.15	2.79	2.50	2.25	2.04	1.87	1.71	1.46
30	0.34	0.64	1.72	2.72	3.68	4.61	5.97	7.30	8.60	9.89	11.6	9.87	7.83	6.41	5.37	4.59	3.98	3.49	3.10	2.77	2.50	2.27	2.07	1.90	1.62
32	0.37	0.68	1.84	2.91	3.94	4.94	6.40	7.83	9.23	10.6	12.4	10.9	8.63	7.06	5.92	5.05	4.38	3.85	3.41	3.05	2.75	2.50	2.28	2.09	1.78
35	0.40	0.75	2.03	3.21	4.34	5.45	7.06	8.63	10.2	11.7	13.7	12.4	9.87	8.08	6.77	5.78	5.01	4.40	3.90	3.49	3.15	2.86	2.61	2.39	2.09
40	0.47	0.87	2.34	3.71	5.02	6.29	8.15	9.96	11.7	13.5	15.8	15.2	12.1	9.87	8.27	7.06	6.12	5.37	4.77	4.26	3.85	3.49	3.15	2.86	2.50
45	0.53	0.99	2.66	4.21	5.70	7.14	9.26	11.3	13.3	15.3	17.9	18.1	14.4	11.8	9.87	8.43	7.31	6.41	5.69	5.09	4.50	4.00	3.60	3.20	2.80

- Note: 1. kW ratings when using one pitch offset links (OL) are 80% of the above. Two pitch offset links (2POL) can be used at 100% of the above values.
 2. Please contact a Tsubaki representative prior to use of kW ratings in the colored area of the table.

Multi-strand factor	Number of chain strands	Multi-strand factor
	Double strand	1.7
	Triple strand	2.5

Lubrication method	A	Manual lubrication or drip lubrication	Details on Pg. 202
	B	Oil bath or slinger disc lubrication	
	C	Forced pump lubrication	

RS35 Sprocket

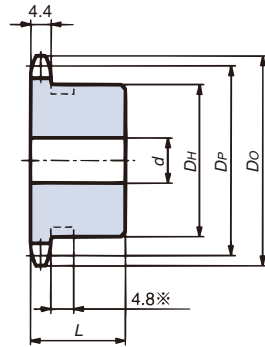

Mechanically machined (1B type)

Number of Teeth	Pitch Circular Diameter (DP)	Sprocket Outer Diameter (DO)	1B type					Approximate Weight (g)	Material	Number of Teeth
			Bore Diameter (d)		Hub					
			Pilot Bore Diameter	Maximum	Diameter (DH)	Length (L)				
9	27.85	32	8	11	22	20	0.05	※	9	
10	30.82	35	8	12	25	20	0.07	※	10	
11	33.81	38	8	14	27	20	0.08	※	11	
12	36.80	41	8	16.5	31	20	0.11	※	12	
13	39.80	44	9.5	18	32	20	0.12	※	13	
14	42.80	47	9.5	16.5	30	20	0.12	Mechanically machined: machine-structural carbon steel	14	
15	45.81	51	9.5	19	35	20	0.16		15	
16	48.82	54	9.5	20	37	20	0.18		16	
17	51.84	57	9.5	24	41	20	0.22		17	
18	54.85	60	9.5	24.5	44	20	0.25		18	
19	57.87	63	9.5	28.5	47	20	0.29		19	
20	60.89	66	9.5	30	50	20	0.32		20	
21	63.91	69	9.5	32	53	20	0.36		21	
22	66.93	72	9.5	32	53	20	0.37		22	
23	69.95	75	9.5	32	53	20	0.38		23	
24	72.97	78	9.5	32	53	22	0.43		24	
25	76.00	81	12.7	32	53	22	0.43		25	
26	79.02	84	12.7	32	53	22	0.44		26	
27	82.05	87	12.7	32	53	22	0.45		27	
28	85.07	90	12.7	32	53	22	0.47		28	
30	91.12	96	12.7	32	53	22	0.50		30	
32	97.18	102	12.7	32	53	22	0.53		32	
34	103.23	109	12.7	32	53	22	0.56		34	
35	106.26	112	12.7	32	53	22	0.58	35		
36	109.29	115	12.7	32	53	22	0.59	36		
38	115.34	121	13	42	63	25	0.82	38		
40	121.40	127	13	42	63	25	0.86	40		
42	127.46	133	13	42	63	25	0.90	42		
45	136.55	142	13	42	63	25	0.96	45		
48	145.64	151	13	42	63	25	1.0	48		
50	151.69	157	13	42	63	25	1.1	50		
54	163.82	169	13	42	63	25	1.2	54		
60	182.00	187	13	42	63	25	1.4	60		
65	197.15	203	16	45	68	25	1.6	65		
70	212.30	218	16	45	68	25	1.7	70		
75	227.46	233	16	45	68	25	1.9	75		



- Note: 1. Maximum bore diameter is the typical range. Determine bore diameter and key bearing pressure based on general mechanical design.
 2. Shaded areas indicate hardened teeth specifications.
 3. Sprockets marked with an * have an outer groove around the hub. Groove outer diameter is 16 for 9T, 18 for 10T, 22 for 11T, 24 for 12T and 28 for 13T.
 4. All other products do not use hardened teeth, although tooth hardening is available upon request. Contact a Tsubaki representative regarding delivery times.
 5. All models stocked.
 6. The dimensions shown in this catalog are nominal dimensions and differ from actual dimensions.

Model numbering

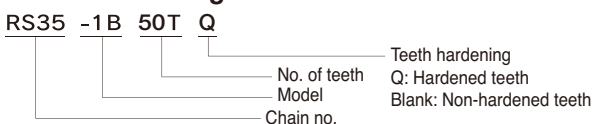

RS40

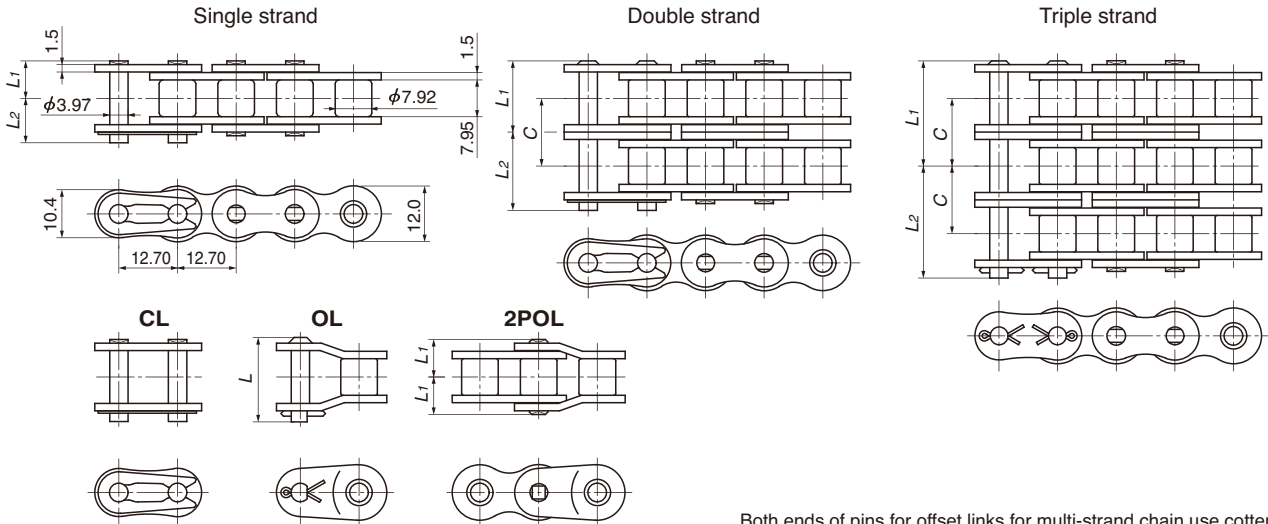

Both ends of pins for offset links for multi-strand chain use cotter pins.

TSUBAKI Chain Number	Number of Strands	Pin Length L _{1+L2}	Dimensions L ₁	Dimensions L ₂	Offset Pin Length L	Transverse Pitch C	Pin Type	ANSI Standard Min. Tensile Strength kN{kgf}	Tsubaki Minimum Tensile Strength kN{kgf}	Tsubaki Average Tensile Strength kN{kgf}	Maximum Allowable Load kN{kgf}	Approximate Mass kg/m
RS 40-1	1	18.2	8.25	9.95	18.2	14.4	Riveting	13.9 {1418}	17.7 {1800}	19.1 {1950}	3.63 {370}	0.64
RS 40-2	2	32.6	15.45	17.15	33.5			27.8 {2835}	35.3 {3600}	38.2 {3900}	6.18 {630}	1.27
RS 40-3	3	46.8	22.65	24.15	47.9			41.7 {4253}	53.0 {5400}	57.4 {5850}	9.12 {930}	1.90
RS 40-4	4	61.2	29.9	31.3	62.3			-	70.6 {7200}	76.5 {7800}	12.0 {1220}	2.53
RS 40-5	5	75.7	37.1	38.6	76.8			-	88.3 {9000}	95.6 {9750}	14.1 {1440}	3.16
RS 40-6	6	90.1	44.3	45.8	91.2			-	106 {10800}	115 {11700}	16.7 {1700}	3.79

- Note: 1. Maximum allowable load when using a one-pitch offset link (OL) is 65% of the above. Two pitch offset links (2POL) can be used at 100% of the above values.
 2. Number of links per unit = 240
 3. Items in bold are stocked in units, while other items are made-to-order.
 4. The dimensions shown in this catalog are nominal dimensions and differ from actual dimensions.

■ RS40-1 Maximum Kilowatt Ratings Table (kW Ratings for Single Strand Chain)

Small Sprocket No. of teeth	Small Sprocket Max rpm																								
	10	25	50	100	200	300	400	500	700	900	1000	1200	1400	1600	1800	2100	2400	2700	3000	3500	4000	5000	6000	7000	8000
	A										B										C				
9	0.07	0.15	0.28	0.52	0.97	1.40	1.81	2.21	3.00	3.75	3.75	3.75	3.75	3.07	2.58	2.04	1.67	1.40	1.20	0.95	0.78	0.56	0.42	0.34	0.27
10	0.07	0.17	0.31	0.58	1.09	1.57	2.03	2.48	3.36	4.21	4.40	4.40	4.40	3.60	3.02	2.39	1.96	1.64	1.40	1.11	0.91	0.65	0.50	0.39	0.32
11	0.08	0.19	0.35	0.65	1.21	1.74	2.25	2.75	3.72	4.67	5.07	5.07	5.07	4.15	3.48	2.76	2.26	1.89	1.62	1.28	1.05	0.75	0.57	0.45	0.37
12	0.09	0.20	0.38	0.71	1.32	1.91	2.47	3.02	4.09	5.13	5.64	5.67	5.67	4.73	3.97	3.15	2.58	2.16	1.84	1.46	1.20	0.86	0.65	0.52	0.42
13	0.10	0.22	0.41	0.77	1.44	2.08	2.69	3.29	4.46	5.59	6.15	6.18	6.18	5.34	4.47	3.55	2.90	2.43	2.08	1.65	1.35	0.97	0.73	0.58	0.48
14	0.11	0.24	0.45	0.84	1.56	2.25	2.92	3.57	4.83	6.06	6.66	6.70	6.70	5.96	5.00	3.97	3.25	2.72	2.32	1.84	1.51	1.08	0.82	0.65	0.53
15	0.11	0.26	0.48	0.90	1.69	2.43	3.14	3.84	5.20	6.52	7.17	7.21	7.21	6.61	5.54	4.40	3.60	3.02	2.58	2.04	1.67	1.20	0.91	0.72	0.59
16	0.12	0.28	0.52	0.97	1.81	2.60	3.37	4.12	5.58	7.00	7.69	7.74	7.74	7.28	6.10	4.84	3.97	3.32	2.84	2.25	1.84	1.32	1.00	0.80	0.65
17	0.13	0.30	0.55	1.03	1.93	2.78	3.60	4.40	5.96	7.47	8.21	8.26	8.26	7.98	6.69	5.31	4.34	3.64	3.11	2.47	2.02	1.44	1.10	0.87	0.71
18	0.14	0.32	0.59	1.10	2.05	2.96	3.83	4.68	6.34	7.94	8.73	8.79	8.79	8.69	7.28	5.78	4.73	3.97	3.39	2.69	2.20	1.57	1.20	0.95	
19	0.15	0.33	0.62	1.17	2.18	3.13	4.06	4.96	6.72	8.42	9.26	9.43	9.43	9.43	7.90	6.27	5.13	4.30	3.67	2.91	2.38	1.71	1.30	1.03	
20	0.15	0.35	0.66	1.23	2.30	3.31	4.29	5.24	7.10	8.90	9.79	10.2	10.2	10.2	8.53	6.77	5.54	4.64	3.97	3.15	2.58	1.84	1.40	1.11	
21	0.16	0.37	0.70	1.30	2.42	3.49	4.52	5.53	7.48	9.38	10.3	11.0	11.0	11.0	9.18	7.28	5.96	5.00	4.27	3.39	2.77	1.98	1.51	1.20	
22	0.17	0.39	0.73	1.37	2.55	3.67	4.76	5.81	7.87	9.87	10.8	11.7	11.7	11.7	9.84	7.81	6.39	5.36	4.57	3.63	2.97	2.13	1.62	1.28	
23	0.18	0.41	0.77	1.43	2.67	3.85	4.99	6.10	8.26	10.4	11.4	12.6	12.6	12.6	10.5	8.35	6.83	5.73	4.89	3.88	3.18	2.27	1.73	1.37	
24	0.18	0.43	0.80	1.50	2.80	4.03	5.22	6.39	8.65	10.8	11.9	13.4	13.4	13.4	11.2	8.90	7.28	6.10	5.21	4.14	3.39	2.42	1.84	1.46	
25	0.19	0.45	0.84	1.57	2.93	4.21	5.46	6.67	9.03	11.3	12.5	14.1	14.1	14.1	11.9	9.46	7.74	6.49	5.54	4.40	3.60	2.58	1.96		
26	0.20	0.47	0.88	1.64	3.05	4.40	5.70	6.96	9.43	11.8	13.0	14.7	14.7	14.7	12.6	10.0	8.21	6.88	5.88	4.66	3.82	2.73	2.08		
28	0.22	0.51	0.95	1.77	3.31	4.76	6.17	7.54	10.2	12.8	14.1	16.0	16.0	16.0	14.1	11.2	9.18	7.69	6.57	5.21	4.27	3.05	2.32		
30	0.23	0.55	1.02	1.91	3.56	5.13	6.65	8.13	11.0	13.8	15.2	17.2	17.2	17.2	15.7	12.4	10.2	8.53	7.28	5.78	4.73	3.39	2.58		
32	0.25	0.59	1.10	2.05	3.82	5.50	7.13	8.71	11.8	14.8	16.3	18.4	18.4	18.4	17.3	13.7	11.2	9.40	8.03	6.37	5.21	3.73			
35	0.27	0.65	1.21	2.26	4.21	6.06	7.85	9.60	13.0	16.3	17.9	20.3	20.3	20.3	19.8	15.7	12.8	10.8	9.18	7.28	5.96	4.27			
40	0.31	0.75	1.40	2.60	4.86	7.00	9.07	11.1	15.0	18.8	20.7	24.1	24.1	24.1	24.1	24.1	19.2	15.7	13.1	11.2	8.90	7.28	5.21		
45	0.35	0.85	1.59	2.96	5.52	7.95	10.3	12.6	17.0	21.4	23.5	27.7	27.7	27.7	28.8	28.8	28.8	22.9	18.7	15.7	13.4	10.6	8.69		

- Note: 1. KW rating when using a one-pitch offset link (OL) is 65% of the above. Two pitch offset links (2POL) can be used at 100% of the above values.
 2. Please contact a Tsubaki representative prior to use of kW ratings in the colored area of the table.

Multi-strand factor	Number of chain strands	Multi-strand factor	Number of chain strands	Multi-strand factor
	Double strand	1.7	Quintuple strand	3.9
	Triple strand	2.5	Sextuple strand	4.6
	Quadruple strand	3.3	-	-

Lubrication method	A	Manual lubrication or drip lubrication	Details on Pg. 202
	B	Oil bath or slinger disc lubrication	
	C	Forced pump lubrication	

Before Use | Standard Roller Chains | Lubrication-Free Roller Chains | Heavy Duty Roller Chains | Corrosion Resistant Roller Chains | Specialty Roller Chains | Sprockets | Pin Gear Drives | Accessories | Selection | Handling

RS50

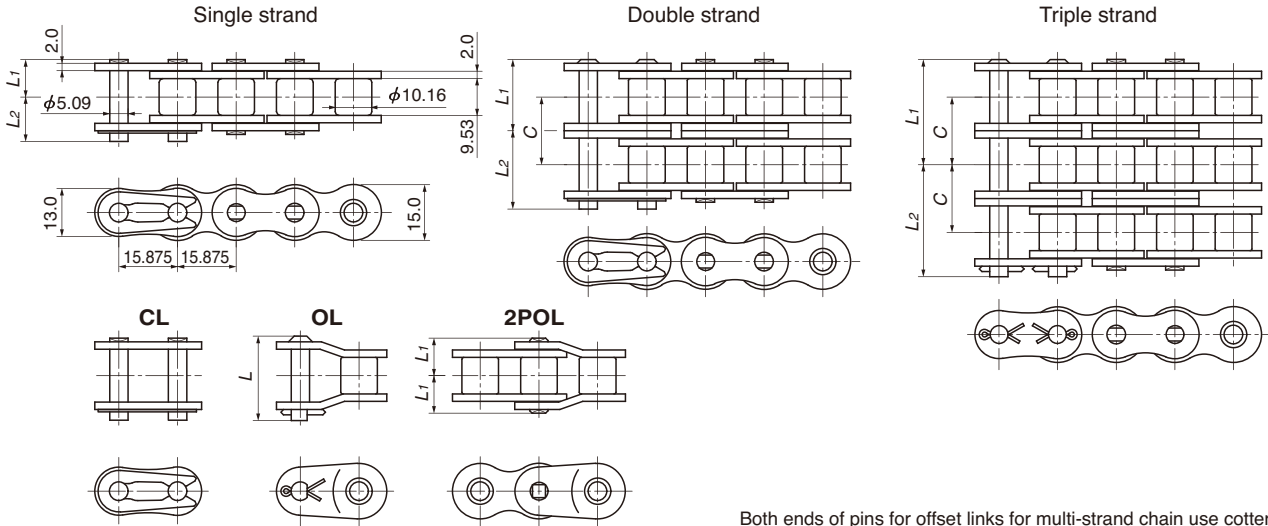

Both ends of pins for offset links for multi-strand chain use cotter pins.

TSUBAKI Chain Number	Number of Strands	Pin Length L ₁ +L ₂	Dimensions L ₁	Dimensions L ₂	Offset Pin Length L	Transverse Pitch C	Pin Type	ANSI Standard Min. Tensile Strength kN{kgf}	Tsubaki Minimum Tensile Strength kN{kgf}	Tsubaki Average Tensile Strength kN{kgf}	Maximum Allowable Load kN{kgf}	Approximate Mass kg/m
RS50-1	1	22.2	10.3	11.9	22.6	18.1	Riveting	21.8 {2223}	28.4 {2900}	31.4 {3200}	6.37{650}	1.04
RS50-2	2	40.5	19.35	21.15	41.8			43.6 {4446}	56.9 {5800}	62.8 {6400}	10.8{1100}	2.07
RS50-3	3	58.6	28.4	30.2	59.9			65.4 {6669}	85.3 {8700}	94.1 {9600}	16.0{1630}	3.09
RS50-4	4	76.7	37.45	39.25	78.1			-	114 {11600}	126 {12800}	21.1{2150}	4.11
RS50-5	5	94.8	46.5	48.3	96.2			-	142 {14500}	157 {16000}	24.9{2540}	5.14
RS50-6	6	113.0	55.6	57.4	114.4			-	171 {17400}	188 {19200}	29.3{2990}	6.16

- Note: 1. Maximum allowable load when using a one-pitch offset link (OL) is 65% of the above. Two pitch offset links (2POL) can be used at 100% of the above values.
 2. Number of links per unit = 192
 3. Items in bold are stocked in units, while other items are made-to-order.
 4. The dimensions shown in this catalog are nominal dimensions and differ from actual dimensions.

■ RS50-1 Maximum Kilowatt Ratings Table (kW Ratings for Single Strand Chain)

Small Sprocket No. of Teeth	Small Sprocket Max rpm																								
	10	25	50	100	200	300	400	500	700	900	1000	1200	1400	1600	1800	2100	2400	2700	3000	3500	4000	4500	5000	5500	6000
	A												B						C						
9	0.14	0.33	0.61	1.14	2.13	3.07	3.97	4.86	6.35	6.35	6.35	5.66	4.49	3.67	3.08	2.44	2.00	1.68	1.43	1.14	0.93	0.78	0.67	0.58	0.51
10	0.16	0.37	0.69	1.28	2.39	3.44	4.45	5.44	7.11	7.11	7.11	6.62	5.26	4.30	3.61	2.86	2.34	1.96	1.68	1.33	1.09	0.91	0.78	0.68	0.59
11	0.18	0.41	0.76	1.42	2.64	3.81	4.93	6.03	7.88	7.88	7.88	7.64	6.07	4.96	4.16	3.30	2.70	2.26	1.93	1.53	1.26	1.05	0.90	0.78	0.68
12	0.20	0.45	0.83	1.56	2.90	4.18	5.42	6.63	8.71	8.71	8.71	8.71	6.91	5.66	4.74	3.76	3.08	2.58	2.20	1.75	1.43	1.20	1.02	0.89	0.78
13	0.21	0.49	0.91	1.70	3.17	4.56	5.91	7.22	9.78	9.82	9.82	9.82	7.79	6.38	5.34	4.24	3.47	2.91	2.48	1.97	1.61	1.35	1.15	1.00	0.88
14	0.23	0.53	0.99	1.84	3.43	4.94	6.40	7.83	10.6	11.0	11.0	11.0	8.71	7.13	5.97	4.74	3.88	3.25	2.78	2.20	1.80	1.51	1.29	1.12	0.98
15	0.25	0.57	1.06	1.98	3.70	5.32	6.90	8.43	11.4	12.2	12.2	12.2	9.66	7.90	6.62	5.26	4.30	3.61	3.08	2.44	2.00	1.68	1.43	1.24	1.08
16	0.27	0.61	1.14	2.12	3.96	5.71	7.40	9.04	12.2	13.4	13.4	13.4	10.6	8.71	7.30	5.79	4.74	3.97	3.39	2.69	2.20	1.85	1.58	1.37	1.18
17	0.29	0.65	1.22	2.27	4.23	6.10	7.90	9.65	13.1	14.7	14.7	14.7	11.7	9.54	7.99	6.34	5.19	4.35	3.71	2.95	2.41	2.02	1.73	1.50	1.28
18	0.30	0.69	1.29	2.41	4.50	6.48	8.40	10.3	13.9	15.8	15.8	15.8	12.7	10.4	8.71	6.91	5.66	4.74	4.05	3.21	2.63	2.20	1.88	1.62	1.38
19	0.32	0.73	1.37	2.56	4.77	6.87	8.90	10.9	14.7	16.8	16.8	16.8	13.8	11.3	9.44	7.49	6.13	5.14	4.39	3.48	2.85	2.39	2.04	1.74	1.48
20	0.34	0.78	1.45	2.70	5.04	7.26	9.41	11.5	15.6	17.7	17.7	17.7	14.9	12.2	10.2	8.09	6.62	5.55	4.74	3.76	3.08	2.58	2.20	1.86	1.57
21	0.35	0.82	1.53	2.85	5.32	7.66	9.92	12.1	16.4	18.7	18.7	18.7	16.0	13.1	11.0	8.71	7.13	5.97	5.10	4.05	3.31	2.78	2.37	1.98	1.65
22	0.37	0.86	1.61	3.00	5.59	8.05	10.4	12.8	17.3	19.6	19.6	19.6	17.2	14.0	11.8	9.34	7.64	6.41	5.47	4.34	3.55	2.98	2.54	2.11	1.74
23	0.39	0.90	1.68	3.14	5.87	8.45	10.9	13.4	18.1	20.6	20.6	20.6	18.3	15.0	12.6	9.98	8.17	6.85	5.85	4.64	3.80	3.18	2.69	2.23	1.82
24	0.40	0.95	1.76	3.29	6.14	8.85	11.5	14.0	19.0	21.6	21.6	21.6	19.5	16.0	13.4	10.6	8.71	7.30	6.23	4.94	4.05	3.39	2.86	2.37	1.93
25	0.42	0.99	1.84	3.44	6.42	9.24	12.0	14.6	19.8	22.5	22.5	22.5	20.8	17.0	14.3	11.3	9.26	7.76	6.62	5.26	4.30	3.61	3.02	2.51	2.04
26	0.44	1.03	1.92	3.59	6.70	9.64	12.5	15.3	20.7	23.5	23.5	23.5	22.0	18.0	15.1	12.0	9.82	8.23	7.03	5.58	4.56	3.82	3.18	2.63	2.13
28	0.47	1.12	2.08	3.89	7.25	10.4	13.5	16.5	22.4	25.5	25.5	25.5	24.6	20.2	16.9	13.4	11.0	9.20	7.85	6.23	5.10	4.27	3.54	2.95	2.41
30	0.51	1.20	2.24	4.19	7.81	11.3	14.6	17.8	24.1	27.5	27.5	27.5	27.3	22.4	18.7	14.9	12.2	10.2	8.71	6.91	5.66	4.64	3.82	3.15	2.58
32	0.54	1.29	2.41	4.49	8.38	12.1	15.6	19.1	25.9	30.1	30.1	30.1	30.1	24.6	20.6	16.4	13.4	11.2	9.59	7.61	6.23	5.10	4.27	3.54	2.95
35	0.59	1.42	2.65	4.95	9.23	13.3	17.2	21.1	28.5	34.4	34.4	34.4	34.4	28.2	23.6	18.7	15.3	12.9	11.0	8.71	7.13	5.85	4.82	3.95	3.23
40	0.67	1.64	3.06	5.71	10.7	15.4	19.9	24.3	32.9	41.3	42.1	42.1	42.1	34.4	28.8	22.9	18.7	15.7	13.4	10.6	8.71	7.13	5.85	4.82	3.95
45	0.76	1.86	3.48	6.49	12.1	17.4	22.6	27.6	37.4	46.9	48.9	48.9	48.9	41.1	34.4	27.3	22.4	18.7	16.0	12.6	10.6	8.71	7.13	5.85	4.82

- Note: 1. KW rating when using a one-pitch offset link (OL) is 65% of the above. Two pitch offset links (2POL) can be used at 100% of the above values.
 2. Please contact a Tsubaki representative prior to use of kW ratings in the colored area of the table.

Multi-strand factor	Number of chain strands	Multi-strand factor	Number of chain strands	Multi-strand factor	Lubrication method	A	Details on Pg. 202
	Double strand	1.7	Quintuple strand	3.9		B	
Triple strand	2.5	Sextuple strand	4.6	C			
Quadruple strand	3.3	-	-	-	C	Forced pump lubrication	

Before Use | Standard Roller Chains | Lubrication-Free Roller Chains | Heavy Duty Roller Chains | Corrosion Resistant Roller Chains | Specialty Roller Chains | Sprockets | Pin Gear Drives | Accessories | Selection | Handling

RS60

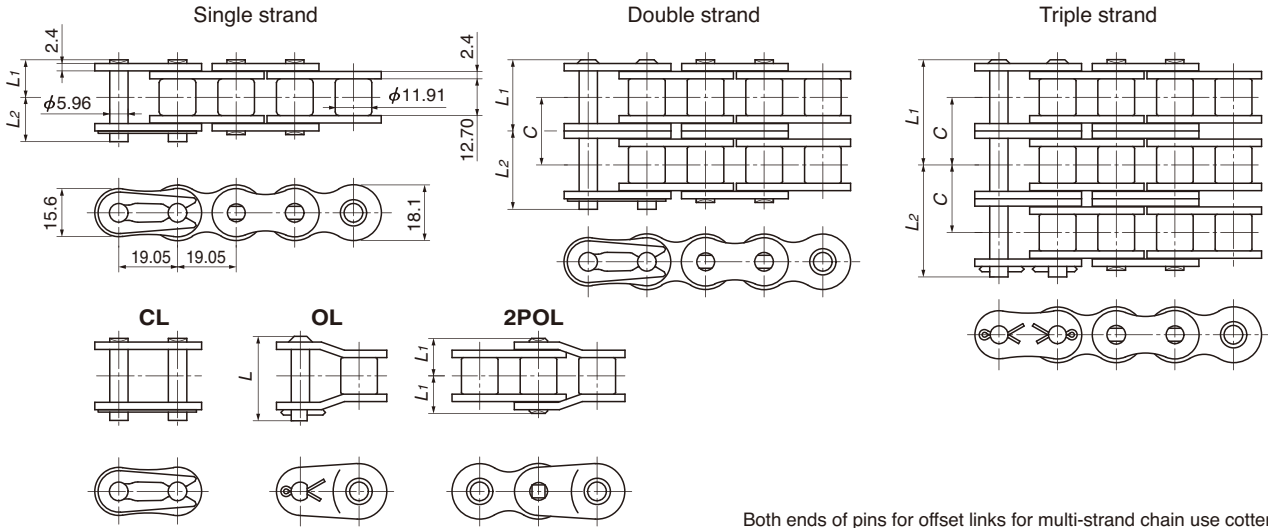

Both ends of pins for offset links for multi-strand chain use cotter pins.

TSUBAKI Chain Number	Number of Strands	Pin Length L ₁ +L ₂	Dimensions L ₁	Dimensions L ₂	Offset Pin Length L	Transverse Pitch C	Pin Type	ANSI Standard Min. Tensile Strength kN{kgf}	Tsubaki Minimum Tensile Strength kN{kgf}	Tsubaki Average Tensile Strength kN{kgf}	Maximum Allowable Load kN{kgf}	Approximate Mass kg/m
RS60-1	1	27.6	12.85	14.75	28.2	22.8	Riveting Cotter pin	31.3 {3192}	40.2 {4100}	44.1 {4500}	8.83 {900}	1.53
RS60-2	2	50.5	24.25	26.25	52.6		Riveting	62.6 {6384}	80.4 {8200}	88.3 {9000}	15.0 {1530}	3.04
RS60-3	3	73.8	35.65	38.15	75.5			121 {12300}	132 {13500}	22.1 {2250}	4.54	
RS60-4	4	96.6	47.05	49.55	98.3			-	161 {16400}	177 {18000}	29.1 {2970}	6.04
RS60-5	5	119.5	58.5	61.0	121.2			-	201 {20500}	221 {22500}	34.4 {3510}	7.54
RS60-6	6	142.4	69.9	72.5	144.0			-	241 {24600}	265 {27000}	40.6 {4140}	9.05

- Note: 1. Maximum allowable load when using a one-pitch offset link (OL) is 65% of the above. Two pitch offset links (2POL) can be used at 100% of the above values.
 2. Number of links per unit = 160
 3. Items in bold are stocked in units, while other items are made-to-order.
 4. The dimensions shown in this catalog are nominal dimensions and differ from actual dimensions.

■ RS60-1 Maximum Kilowatt Ratings Table (kW Ratings for Single Strand Chain)

Small Sprocket No. of Teeth	Small Sprocket Max rpm																											
	A							B														C						
	10	25	50	100	150	200	300	400	500	600	700	800	900	1000	1100	1200	1400	1600	1800	2000	2500	3000	3500	4000	4500			
9	0.24	0.55	1.02	1.90	2.73	3.54	5.10	6.61	8.08	9.52	10.1	10.1	10.1	8.6	7.46	6.54	5.19	4.25	3.56	3.04	2.18	1.66	1.31	1.08	0.90			
10	0.27	0.61	1.14	2.13	3.06	3.97	5.72	7.41	9.05	10.7	11.4	11.4	11.4	10.1	8.73	7.66	6.08	4.98	4.17	3.56	2.55	1.94	1.54	1.26	1.06			
11	0.30	0.68	1.26	2.36	3.40	4.40	6.34	8.21	10.0	11.8	12.7	12.7	12.7	11.6	10.1	8.84	7.02	5.74	4.81	4.11	2.94	2.24	1.78	1.45	1.22			
12	0.33	0.74	1.39	2.59	3.73	4.83	6.96	9.02	11.0	13.0	13.9	13.9	13.9	13.2	11.5	10.1	8.00	6.54	5.48	4.68	3.35	2.55	2.02	1.66	1.39			
13	0.36	0.81	1.51	2.82	4.07	5.27	7.59	9.83	12.0	14.2	15.2	15.2	15.2	14.9	12.9	11.4	9.02	7.38	6.18	5.28	3.78	2.87	2.28	1.87				
14	0.39	0.88	1.64	3.06	4.41	5.71	8.22	10.7	13.0	15.3	16.7	16.7	16.7	16.7	14.5	12.7	10.1	8.25	6.91	5.90	4.22	3.21	2.55	2.09				
15	0.41	0.95	1.77	3.30	4.75	6.15	8.86	11.5	14.0	16.5	18.5	18.5	18.5	18.5	16.0	14.1	11.2	9.15	7.66	6.54	4.68	3.56	2.83	2.31				
16	0.44	1.01	1.89	3.53	5.09	6.59	9.50	12.3	15.0	17.7	20.4	20.4	20.4	20.4	17.7	15.5	12.3	10.1	8.44	7.21	5.16	3.92	3.11	2.55				
17	0.47	1.08	2.02	3.77	5.43	7.04	10.1	13.1	16.1	18.9	21.7	22.3	22.3	22.3	19.4	17.0	13.5	11.0	9.25	7.90	5.65	4.30	3.41	2.79				
18	0.50	1.15	2.15	4.01	5.78	7.49	10.8	14.0	17.1	20.1	23.1	23.7	23.7	23.7	21.1	18.5	14.7	12.0	10.1	8.60	6.16	4.68	3.72	3.04				
19	0.53	1.22	2.28	4.25	6.13	7.94	11.4	14.8	18.1	21.3	24.5	25.1	25.1	25.1	22.9	20.1	15.9	13.0	10.9	9.33	6.68	5.08	4.03	3.30				
20	0.56	1.29	2.41	4.50	6.48	8.39	12.1	15.7	19.1	22.6	25.9	26.6	26.6	26.6	24.7	21.7	17.2	14.1	11.8	10.1	7.21	5.48	4.35					
21	0.59	1.36	2.54	4.74	6.83	8.84	12.7	16.5	20.2	23.8	27.3	28.0	28.0	28.0	26.6	23.3	18.5	15.2	12.7	10.8	7.76	5.90	4.68					
22	0.62	1.43	2.67	4.98	7.18	9.30	13.4	17.4	21.2	25.0	28.7	29.5	29.5	29.5	28.5	25.0	19.8	16.2	13.6	11.6	8.32	6.33	5.02					
23	0.64	1.50	2.80	5.23	7.53	9.76	14.1	18.2	22.3	26.2	30.1	30.9	30.9	30.9	30.5	26.7	21.2	17.4	14.6	12.4	8.89	6.76	5.37					
24	0.67	1.57	2.93	5.47	7.89	10.2	14.7	19.1	23.3	27.5	31.5	32.5	32.5	32.5	32.5	28.5	22.6	18.5	15.5	13.2	9.48	7.21	5.72					
25	0.70	1.64	3.07	5.72	8.24	10.7	15.4	19.9	24.4	28.7	33.0	34.5	34.5	34.5	34.5	30.3	24.0	19.7	16.5	14.1	10.1	7.66	6.08					
26	0.73	1.71	3.20	5.97	8.60	11.1	16.0	20.8	25.4	29.9	34.4	36.6	36.6	36.6	36.6	32.1	25.5	20.9	17.5	14.9	10.7	8.13	6.45					
28	0.78	1.86	3.47	6.47	9.31	12.1	17.4	22.5	27.5	32.4	37.3	40.9	40.9	40.9	40.9	35.9	28.5	23.3	19.5	16.7	11.9	9.09						
30	0.84	2.00	3.73	6.97	10.0	13.0	18.7	24.3	29.7	34.9	40.1	44.9	44.9	44.9	44.9	39.8	31.6	25.9	21.7	18.5	13.2	10.1						
32	0.90	2.14	4.00	7.47	10.8	13.9	20.1	26.0	31.8	37.5	43.0	48.1	48.1	48.1	48.1	43.9	34.8	28.5	23.9	20.4	14.6	11.1						
35	0.98	2.36	4.41	8.23	11.9	15.4	22.1	28.7	35.0	41.3	47.4	53.0	53.0	53.0	53.0	50.2	39.8	32.6	27.3	23.3	16.7	12.7						
40	1.12	2.73	5.09	9.50	13.7	17.7	25.5	33.1	40.5	47.7	54.8	61.3	61.3	61.3	61.3	61.3	48.7	39.8	33.4	28.5	20.4							
45	1.26	3.10	5.78	10.8	15.5	20.1	29.0	37.6	45.9	54.1	62.2	70.1	73.2	73.2	73.2	73.2	58.1	47.5	39.8	34.0	24.3							

- Note: 1. KW rating when using a one-pitch offset link (OL) is 65% of the above. Two pitch offset links (2POL) can be used at 100% of the above values.
 2. Please contact a Tsubaki representative prior to use of kW ratings in the colored area of the table.

Multi-strand factor	Number of chain strands	Multi-strand factor	Number of chain strands	Multi-strand factor	Lubrication method	A	Manual lubrication or drip lubrication	Details on Pg. 202
	Double strand	1.7	Quintuple strand	3.9		B	Oil bath or slinger disc lubrication	
	Triple strand	2.5	Sextuple strand	4.6		C	Forced pump lubrication	
	Quadruple strand	3.3	-	-				

RS60 Sprocket

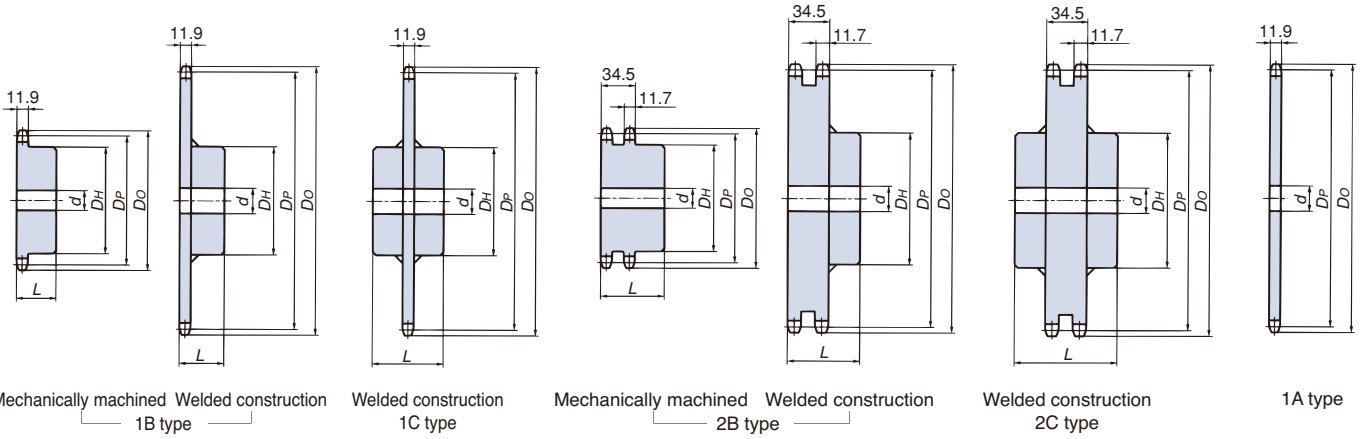

Number of Teeth	1B type				1C type				2B type				2C type				1A type		Number of Teeth
	Bore Diameter (d)		Hub		Bore Diameter (d)		Hub		Bore Diameter (d)		Hub		Bore Diameter (d)		Hub		Pitch Bore Diameter	Approx. Mass (kg)	
	Pilot Bore Diameter	Maximum	Diameter (Dh)	Length (L)	Pilot Bore Diameter	Maximum	Diameter (Dh)	Length (L)	Pilot Bore Diameter	Maximum	Diameter (Dh)	Length (L)	Pilot Bore Diameter	Maximum	Diameter (Dh)	Length (L)			
9	55.70	64	9.5	24.5	43	32	0.36	※											9
10	61.65	70	12.7	30	49	32	0.45	※											10
11	67.62	76	12.7	32	51	32	0.55	※											11
12	73.60	83	12.7	32	51	32	0.63												12
13	79.60	89	15.9	35	57	32	0.76												13
14	85.61	95	15.9	39.5	62	32	0.90												14
15	91.63	101	15.9	45.5	68	32	1.1												15
16	97.65	107	15.9	47.5	73	32	1.2												16
17	103.67	113	15.9	47.5	73	32	1.3												17
18	109.70	119	15.9	55	83	40	1.9												18
19	115.74	126	15.9	55	83	40	2.0												19
20	121.78	132	15.9	55	83	40	2.1												20
21	127.82	138	15.9	55	83	40	2.2												21
22	133.86	144	15.9	55	83	40	2.3												22
23	139.90	150	18	55	83	40	2.4												23
24	145.95	156	18	55	83	40	2.6												24
25	151.99	162	18	55	83	40	2.7												25
26	158.04	168	18	55	83	40	2.8												26
27	164.09	174	18	55	83	40	3.0												27
28	170.14	180	18	55	83	40	3.1												28
30	182.25	193	18	55	83	40	3.4		18	55	83	50	3.6						30
32	194.35	205	18	55	83	40	3.8		18	55	83	50	3.9						32
34	206.46	217	18	55	83	40	4.1		18	55	83	50	4.2						34
35	212.52	223	18	55	83	40	4.3		18	55	83	50	4.5						35
36	218.57	229	18	55	83	40	4.5		18	55	83	50	4.7						36
38	230.69	241	18	55	83	40	4.9		18	55	83	50	4.9						38
40	242.80	253	18	55	83	40	5.3		18	63	93	55	6.0						40
42	254.92	266	23	63	93	45	6.2		18	63	93	55	6.4						42
45	273.09	284	23	63	93	45	6.9		23	63	93	55	6.7						45
48	291.27	302	23	63	93	45	7.6		23	63	93	55	7.4						48
50	303.39	314	23	63	93	45	8.2		23	63	93	55	8.2						50
54	327.63	338	23	63	93	45	9.3		23	63	93	55	8.7						54
60	363.99	375	23	63	93	45	11.1		23	63	93	55	9.8						60
65	394.30	405	28	75	107	45	13.2		23	75	107	70	13.3						65
70	424.61	436	28	75	107	45	15.0		28	75	107	70	14.9						70
75	454.92	466	28	75	107	45	16.9		28	75	107	70	16.7						75

- Note: 1. Maximum bore diameter is the typical range. Determine bore diameter and key bearing pressure based on general mechanical design
2. Outer diameters in the table above are for 1B models. Diameters may vary for other models.
3. 1B type sprockets have an outer groove around the hub. (Shown in the diagram on the right.) Groove outer diameter is 32 for 9T, 37 for 10T and 45 for 11T.
4. Weld specifications: carbon steel for machine structural use or rolled steel for general structural use
5. Shaded areas indicate hardened teeth specifications.
6. All other products do not use hardened teeth, although tooth hardening is available upon request. Contact a Tsubaki representative regarding delivery times.
7. Items with dimensions in thin font are made-to-order. All other items are stocked.
8. The dimensions shown in this catalog are nominal dimensions and differ from actual dimensions.

Hanging hole dimensions

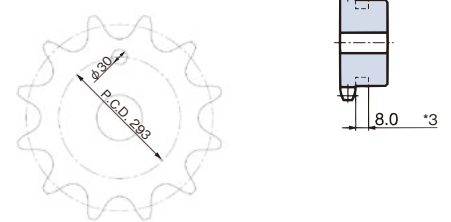

The phase relationship between the hanging hole and teeth may vary.

Model numbering

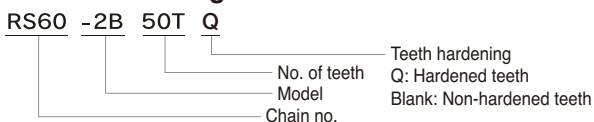

RS80

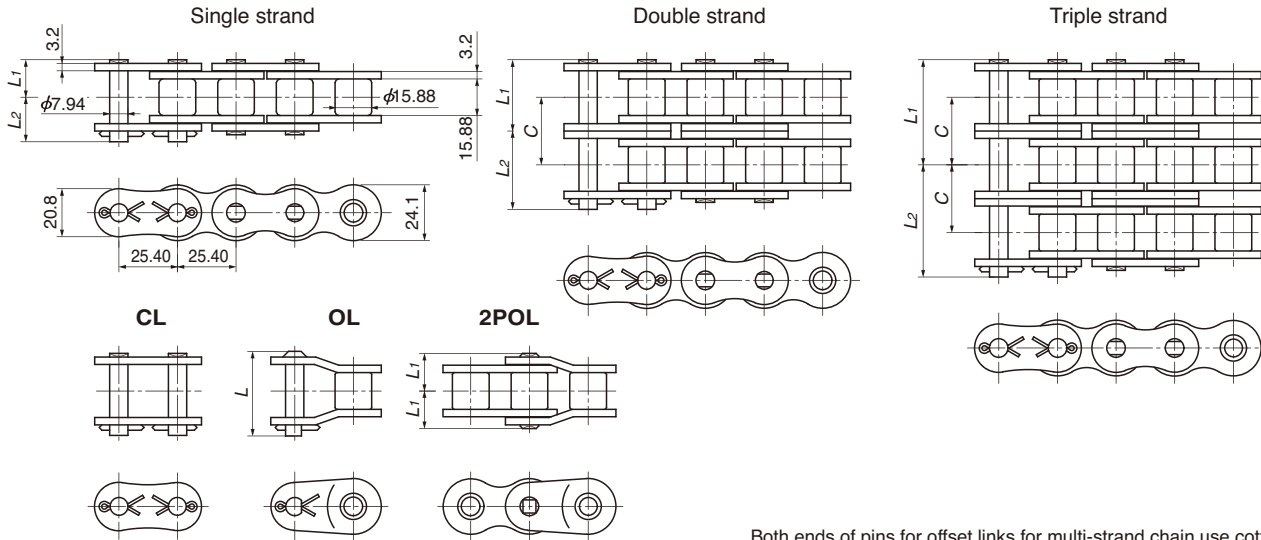

Both ends of pins for offset links for multi-strand chain use cotter pins.

TSUBAKI Chain Number	Number of Strands	Pin Length L ₁ +L ₂	Dimensions L ₁	Dimensions L ₂	Offset Pin Length L	Transverse Pitch C	Pin Type	ANSI Standard Min. Tensile Strength kN{kgf}	Tsubaki Minimum Tensile Strength kN{kgf}	Tsubaki Average Tensile Strength kN{kgf}	Maximum Allowable Load kN{kgf}	Approximate Mass kg/m
RS80-1	1	35.5	16.25	19.25	36.6	29.3	Riveting Cotter pin	55.6 {5670}	71.6{7300}	78.5{8000}	14.7{1500}	2.66
RS80-2	2	64.8	30.9	33.9	67.5		Riveting	111.2{11340}	143 {14600}	157 {16000}	25.0{2550}	5.27
RS80-3	3	94.1	45.6	48.5	96.9			166.8{17009}	215 {21900}	235 {24000}	36.8{3750}	7.89
RS80-4	4	123.5	60.25	63.25	126.3			-	286 {29200}	314 {32000}	48.5{4950}	10.50
RS80-5	5	152.9	74.95	77.95	155.6			-	358 {36500}	392 {40000}	57.4{5850}	13.11
RS80-6	6	182.1	89.6	92.5	184.9			-	430 {43800}	471 {48000}	67.7{6900}	15.73

- Note: 1. Maximum allowable load when using a one-pitch offset link (OL) is 65% of the above. Two pitch offset links (2POL) can be used at 100% of the above values.
 2. Number of links per unit = 120
 3. Items in bold are stocked in units, while other items are made-to-order.
 4. The dimensions shown in this catalog are nominal dimensions and differ from actual dimensions.

■ RS80-1 Maximum Kilowatt Ratings Table (kW Ratings for Single Strand Chain)

Small Sprocket No. of Teeth	Small Sprocket Max rpm																								
	A										B										C				
	10	25	50	100	150	200	300	400	500	600	700	800	900	1000	1100	1200	1400	1600	1800	2000	2200	2400	2700	3000	3400
9	0.53	1.21	2.26	4.21	6.07	7.86	11.3	14.7	17.9	18.2	18.2	15.1	12.7	10.8	9.39	8.24	6.54	5.35	4.48	3.83	3.32	2.91	2.44	2.08	1.73
10	0.59	1.36	2.53	4.72	6.80	8.81	12.7	16.4	20.1	20.4	20.4	17.7	14.9	12.7	11.0	9.65	7.66	6.27	5.25	4.48	3.89	3.41	2.86	2.44	2.02
11	0.66	1.50	2.80	5.23	7.54	9.76	14.1	18.2	22.3	22.6	22.6	20.4	17.1	14.6	12.7	11.1	8.83	7.23	6.06	5.17	4.48	3.94	3.30	2.82	1.27
12	0.72	1.65	3.08	5.75	8.28	10.7	15.4	20.0	24.5	24.9	24.9	23.3	19.5	16.7	14.5	12.7	10.1	8.24	6.90	5.89	5.11	4.48	3.76	3.21	
13	0.79	1.80	3.36	6.27	9.03	11.7	16.8	21.8	26.7	27.1	27.1	26.3	22.0	18.8	16.3	14.3	11.3	9.29	7.78	6.65	5.76	5.06	4.24	3.62	
14	0.85	1.95	3.64	6.79	9.78	12.7	18.2	23.6	28.9	29.4	29.4	24.6	21.0	18.2	16.0	12.7	10.4	8.70	7.43	6.44	5.65	4.74	4.04		
15	0.92	2.10	3.92	7.31	10.5	13.6	19.7	25.5	31.1	32.6	32.6	27.3	23.3	20.2	17.7	14.1	11.5	9.65	8.24	7.14	6.27	5.25	4.48		
16	0.99	2.25	4.20	7.84	11.3	14.6	21.1	27.3	33.4	35.9	35.9	30.1	25.7	22.2	19.5	15.5	12.7	10.6	9.08	7.87	6.90	5.79	4.94		
17	1.05	2.40	4.49	8.37	12.1	15.6	22.5	29.2	35.6	39.3	39.3	32.9	28.1	24.4	21.4	17.0	13.9	11.6	9.94	8.62	7.56	6.34	5.41		
18	1.12	2.56	4.77	8.91	12.8	16.6	23.9	31.0	37.9	42.8	42.8	35.9	30.6	26.5	23.3	18.5	15.1	12.7	10.8	9.39	8.24	6.90	5.89		
19	1.18	2.71	5.06	9.44	13.6	17.6	25.4	32.9	40.2	46.0	46.0	38.9	33.2	28.8	25.3	20.1	16.4	13.8	11.7	10.2	8.93	7.49	6.39		
20	1.24	2.87	5.35	9.98	14.4	18.6	26.8	34.8	42.5	48.7	48.7	42.0	35.9	31.1	27.3	21.7	17.7	14.9	12.7	11.0	9.65	8.09			
21	1.31	3.02	5.64	10.5	15.2	19.6	28.3	36.6	44.8	51.3	51.3	45.2	38.6	33.5	29.4	23.3	19.1	16.0	13.6	11.8	10.4	8.70			
22	1.37	3.18	5.93	11.1	15.9	20.6	29.7	38.5	47.1	53.9	53.9	48.5	41.4	35.9	31.5	25.0	20.4	17.1	14.6	12.7	11.1	9.33			
23	1.43	3.33	6.22	11.6	16.7	21.7	31.2	40.4	49.4	56.6	56.6	51.8	44.2	38.3	33.7	26.7	21.9	18.3	15.6	13.6	11.9	9.97			
24	1.49	3.49	6.51	12.2	17.5	22.7	32.7	42.3	51.7	59.3	59.3	55.2	47.2	40.9	35.9	28.5	23.3	19.5	16.7	14.5	12.7	10.6			
25	1.56	3.65	6.81	12.7	18.3	23.7	34.1	44.2	54.1	61.9	61.9	58.7	50.1	43.5	38.1	30.3	24.8	20.8	17.7	15.4	13.5	11.3			
26	1.62	3.80	7.10	13.2	19.1	24.7	35.6	46.1	56.4	64.6	64.6	62.3	53.2	46.1	40.5	32.1	26.3	22.0	18.8	16.3	14.3	12.0			
28	1.74	4.12	7.69	14.4	20.7	26.8	38.6	50.0	61.1	70.0	70.0	69.6	59.4	51.5	45.2	35.9	29.4	24.6	21.0	18.2	16.0				
30	1.87	4.44	8.29	15.5	22.3	28.9	41.6	53.8	65.8	77.2	77.2	77.2	65.9	57.1	50.1	39.8	32.6	27.3	23.3	20.2	17.7				
32	1.99	4.76	8.88	16.6	23.9	30.9	44.6	57.7	70.6	83.2	85.0	85.0	72.6	62.9	55.2	43.8	35.9	30.1	25.7	22.2	19.5				
35	2.18	5.24	9.79	18.3	26.3	34.1	49.1	63.6	77.7	91.6	97.3	97.3	83.0	72.0	63.2	50.1	41.0	34.4	29.4	25.5					
40	2.49	6.06	11.3	21.1	30.4	39.4	56.7	73.5	89.8	106	114	114	101	87.9	77.2	61.3	50.1	42.0	35.9	14.9					
45	2.80	6.88	12.8	24.0	34.5	44.7	64.4	83.4	102	120	130	130	121	105	92.1	73.1	59.8	50.1	40.4						

- Note: 1. kW rating when using a one-pitch offset link (OL) is 65% of the above. Two pitch offset links (2POL) can be used at 100% of the above values.
 2. Please contact a Tsubaki representative prior to use of kW ratings in the colored area of the table.

Multi-strand factor	Number of chain strands	Multi-strand factor	Number of chain strands	Multi-strand factor
	Double strand	1.7	Quintuple strand	3.9
	Triple strand	2.5	Sextuple strand	4.6
	Quadruple strand	3.3	-	-

Lubrication method	A	Manual lubrication or drip lubrication	Details on Pg. 202
	B	Oil bath or slinger disc lubrication	
	C	Forced pump lubrication	

RS80 Sprocket

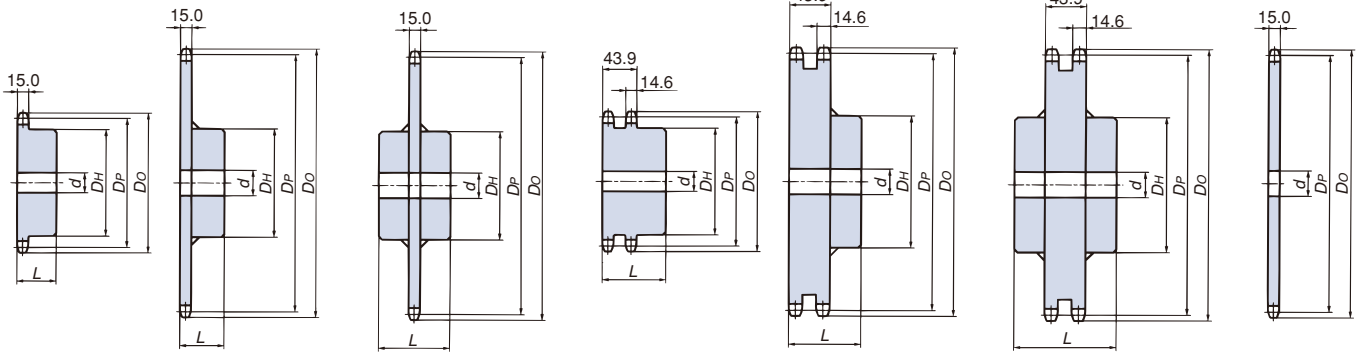

Mechanically machined 1B type, Welded construction 1B type, Welded construction 1C type, Mechanically machined 2B type, Welded construction 2B type, Welded construction 2C type, 1A type

Number of Teeth	1B type							1C type							2B type							2C type							1A type			Number of Teeth
	Pitch Circular Diameter (Dp)	Special Outer Diameter (Do)	Bore Diameter (d)	Hub Diameter (D _H)	Hub Length (L)	Approx. Mass (kg)	Material	Bore Diameter (d)	Hub Diameter (D _H)	Hub Length (L)	Approx. Mass (kg)	Material	Bore Diameter (d)	Hub Diameter (D _H)	Hub Length (L)	Approx. Mass (kg)	Material	Bore Diameter (d)	Hub Diameter (D _H)	Hub Length (L)	Approx. Mass (kg)	Material	Pitch Bore Diameter	Approx. Mass (kg)	Material							
9	74.26	85	15.9	35	58	40	0.79																					9				
10	82.20	93	15.9	32	52	40	0.88																					10				
11	90.16	102	15.9	38	60	40	1.1																					11				
12	98.14	110	19	45	67	40	1.4																					12				
13	106.14	118	19	50	77	40	1.7																					13				
14	114.15	127	19	50	77	40	1.9																					14				
15	122.17	135	19	63	93	40	2.5																					15				
16	130.20	143	19	63	93	40	2.7																					16				
17	138.23	151	19	63	93	40	2.8																					17				
18	146.27	159	19	63	93	40	3.0																					18				
19	154.32	167	23	63	93	40	3.2																					19				
20	162.37	176	23	63	93	40	3.4																					20				
21	170.42	184	23	63	93	40	3.7																					21				
22	178.48	192	28	75	107	45	4.7																					22				
23	186.54	200	28	75	107	45	4.9																					23				
24	194.60	208	28	75	107	45	5.2																					24				
25	202.66	216	28	75	107	45	5.5																					25				
26	210.72	224	28	75	107	45	5.8																					26				
27	218.79	233	28	75	107	45	6.1																					27				
28	226.86	241	28	75	107	45	6.4																					28				
30	243.00	257	28	75	107	45	7.1																					30				
32	259.14	273	28	75	107	45	7.8																					32				
34	275.28	289	28	75	107	45	8.6																					34				
35	283.36	297	28	75	107	45	9.0																					35				
36	291.43	306	33	80	117	50	10.1																					36				
38	307.58	322	33	80	117	50	11.0																					38				
40	323.74	338	33	80	117	50	12.0																					40				
42	339.89	354	33	80	117	50	12.9																					42				
45	364.12	378	33	80	117	50	14.5																					45				
48	388.36	403	33	80	117	50	16.1																					48				
50	404.52	419	33	80	117	50	17.3																					50				
54	436.84	451	33	80	117	50	19.8																					54				
60	485.33	500	33	80	117	50	23.9																					60				
65	525.73	540	33	89	127	63	29.3																					65				
70	566.15	581	33	89	127	63	33.3																					70				
75	606.56	621	33	89	127	63	37.7																					75				

- Note: 1. Maximum bore diameter is the typical range. Determine bore diameter and key bearing pressure based on general mechanical design.
 2. Outer diameters in the table above are for 1B models. Diameters may vary for other models.
 3. 1B type sprockets have an outer groove around the hub. (Shown in the diagram on the right.) Groove outer diameter is 44 for 9T.
 4. Weld specifications: carbon steel for machine structural use or rolled steel for general structural use
 5. Shaded areas indicate hardened teeth specifications.
 6. All other products do not use hardened teeth, although tooth hardening is available upon request. Contact a Tsubaki representative regarding delivery times.
 7. Items with dimensions in thin font are made-to-order. All other items are stocked.
 8. Models in the dimensional chart whose approximate mass is in bold font have one hanging hole. See the diagram on the right for more information.
 9. The dimensions shown in this catalog are nominal dimensions and differ from actual dimensions.

Hanging hole dimensions

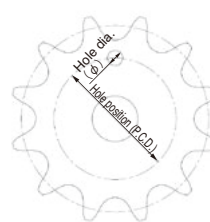

No. of teeth	2B, 2C Type bore dia. (ø30) Hole position (P.C.D.)
40	242
42	258
45	283
48	307
50	323
54	355
60	404

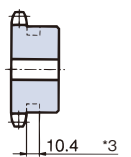

The phase relationship between the hanging hole and teeth may vary.

Model numbering

RS80 -2B 50T Q

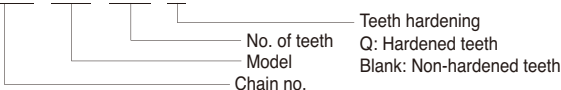

RS100

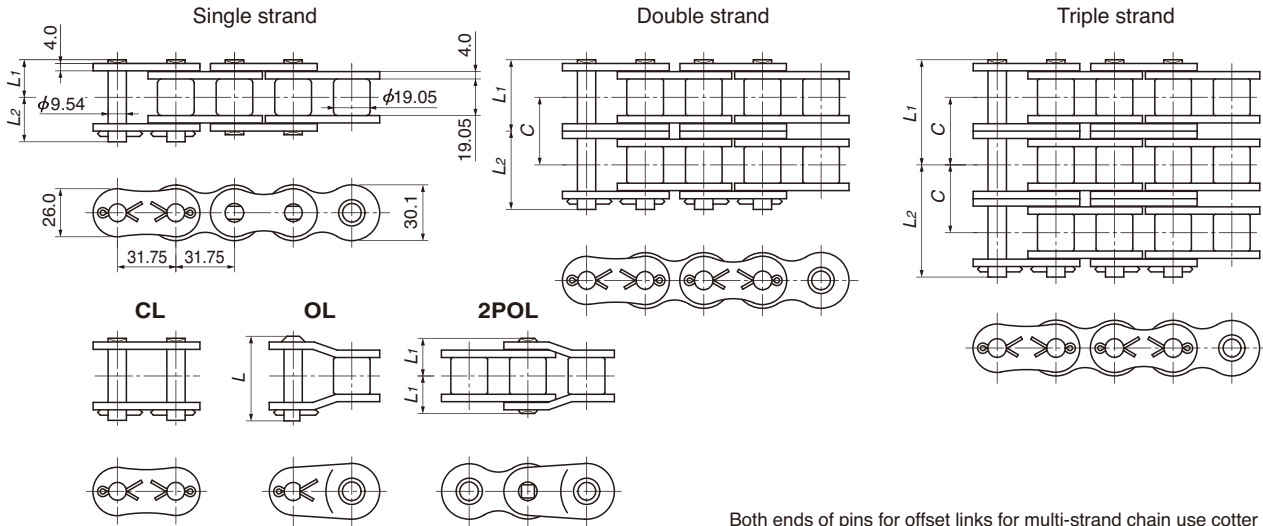

Both ends of pins for offset links for multi-strand chain use cotter pins.

TSUBAKI Chain Number	Number of Strands	Pin Length L ₁ +L ₂	Dimensions L ₁	Dimensions L ₂	Offset Pin Length L	Transverse Pitch C	Pin Type	ANSI Standard Min. Tensile Strength kN{kgf}	Tsubaki Minimum Tensile Strength kN{kgf}	Tsubaki Average Tensile Strength kN{kgf}	Maximum Allowable Load kN{kgf}	Approximate Mass kg/m
RS100-1	1	42.6	19.75	22.85	43.7	35.8	Cotter pin Riveting	87.0 {8872}	107{10900}	118{12000}	22.6 {2300}	3.99
RS100-2	2	78.5	37.7	40.8	81.5		Cotter pin	174.0{17744}	214{21800}	235{24000}	38.3 {3910}	7.85
RS100-3	3	114.4	55.65	58.75	117.3			261.0{26615}	321{32700}	353{36000}	56.4 {5750}	11.77
RS100-4	4	150.2	73.55	76.65	153.1			-	428{43600}	471{48000}	74.4 {7590}	15.70
RS100-5	5	186.1	91.5	94.6	188.9			-	534{54500}	588{60000}	88.0 {8970}	19.53
RS100-6	6	222.0	109.45	112.55	224.7			-	641{65400}	706{72000}	104{10580}	23.48

- Note: 1. Maximum allowable load when using a one-pitch offset link (OL) is 65% of the above. Two pitch offset links (2POL) can be used at 100% of the above values.
 2. Number of links per unit = 96
 3. Items in bold are stocked in units, while other items are made-to-order.
 4. The dimensions shown in this catalog are nominal dimensions and differ from actual dimensions.

■ RS100-1 Maximum Kilowatt Ratings Table (kW Ratings for Single Strand Chain)

Small Sprocket No. of Teeth	Small Sprocket Max rpm																							
	A					B					C													
	10	25	50	100	150	200	300	400	500	600	700	800	900	1000	1100	1200	1300	1400	1600	1800	2000	2200	2400	2600
9	1.02	2.33	4.34	8.10	11.7	15.1	21.8	26.4	26.4	26.4	22.1	18.1	15.2	12.9	11.2	9.85	8.73	7.82	6.40	5.36	4.58	3.97	3.48	3.09
10	1.14	2.61	4.86	9.07	13.1	16.9	24.4	29.6	29.6	29.6	25.9	21.2	17.8	15.2	13.1	11.5	10.2	9.15	7.49	6.28	5.36	4.65	4.08	3.62
11	1.27	2.89	5.39	10.1	14.5	18.8	27.0	32.8	32.8	32.8	29.9	24.4	20.5	17.5	15.2	13.3	11.8	10.6	8.64	7.24	6.18	5.36	4.70	0.96
12	1.39	3.17	5.92	11.0	15.9	20.6	29.7	36.1	36.1	36.1	34.0	27.9	23.3	19.9	17.3	15.2	13.4	12.0	9.85	8.25	7.05	6.11	5.36	
13	1.52	3.46	6.45	12.0	17.3	22.5	32.4	39.3	39.3	39.3	38.4	31.4	26.3	22.5	19.5	17.1	15.2	13.6	11.1	9.31	7.95	6.89	6.04	
14	1.64	3.75	6.99	13.0	18.8	24.3	35.1	42.9	42.9	42.9	42.9	35.1	29.4	25.1	21.8	19.1	16.9	15.2	12.4	10.4	8.88	7.70	6.76	
15	1.77	4.04	7.53	14.1	20.2	26.2	37.8	47.6	47.6	47.6	47.6	38.9	32.6	27.9	24.1	21.2	18.8	16.8	13.8	11.5	9.85	8.54	7.49	
16	1.90	4.33	8.08	15.1	21.7	28.1	40.5	52.4	52.4	52.4	52.4	42.9	35.9	30.7	26.6	23.3	20.7	18.5	15.2	12.7	10.8	9.40	8.25	
17	2.03	4.62	8.62	16.1	23.2	30.0	43.3	56.0	57.4	57.4	57.4	47.0	39.4	33.6	29.1	25.6	22.7	20.3	16.6	13.9	11.9	10.3		
18	2.15	4.92	9.17	17.1	24.7	31.9	46.0	59.6	62.5	62.5	62.5	51.2	42.9	36.6	31.7	27.9	24.7	22.1	18.1	15.2	12.9	11.2		
19	2.27	5.21	9.72	18.1	26.1	33.9	48.8	63.2	67.8	67.8	67.8	55.5	46.5	39.7	34.4	30.2	26.8	24.0	19.6	16.4	14.0	12.2		
20	2.39	5.51	10.3	19.2	27.6	35.8	51.5	66.8	71.9	71.9	71.9	59.9	50.2	42.9	37.2	32.6	28.9	25.9	21.2	17.8	15.2	13.1		
21	2.51	5.81	10.8	20.2	29.1	37.7	54.3	70.4	75.8	75.8	75.8	64.5	54.0	46.1	40.0	35.1	31.1	27.9	22.8	19.1	16.3	14.1		
22	2.63	6.10	11.4	21.3	30.6	39.7	57.1	74.0	79.7	79.7	79.7	69.1	57.9	49.5	42.9	37.6	33.4	29.9	24.4	20.5	17.5	15.2		
23	2.75	6.40	12.0	22.3	32.1	41.6	59.9	77.7	83.7	83.7	83.7	73.9	61.9	52.9	45.8	40.2	35.7	31.9	26.1	21.9	18.7	5.77		
24	2.89	6.71	12.5	23.4	33.6	43.6	62.8	81.3	87.6	87.6	87.6	78.8	66.0	56.4	48.9	42.9	38.0	34.0	27.9	23.3	19.9			
25	2.99	7.01	13.1	24.4	35.2	45.5	65.6	85.0	91.5	91.5	91.5	83.8	70.2	59.9	51.9	45.6	40.4	36.2	29.6	24.8	21.2			
26	3.11	7.31	13.6	25.5	36.7	47.5	68.4	88.7	95.5	95.5	95.5	88.8	74.4	63.6	55.1	48.4	42.9	38.4	31.4	26.3	22.5			
28	3.35	7.92	14.8	27.6	39.7	51.5	74.1	96.0	103	103	103	99.3	83.2	71.0	61.6	54.0	47.9	42.9	35.1	29.4	25.1			
30	3.59	8.53	15.9	29.7	42.8	55.5	79.9	103	111	111	111	110	92.3	78.8	68.3	59.9	53.2	47.6	38.9	32.6	7.50			
32	3.83	9.15	17.1	31.9	45.9	59.5	85.6	111	121	121	121	121	102	86.8	75.2	66.0	58.6	52.4	42.9	33.7				
35	4.19	10.1	18.8	35.1	50.6	65.5	94.3	122	139	139	139	139	116	99.3	86.1	75.5	67.0	59.9	49.1	41.1				
40	4.78	11.6	21.7	40.5	58.4	75.7	109	141	170	170	170	170	142	121	105	92.3	81.8	73.2	59.9					
45	5.38	13.2	24.7	46.0	66.3	85.9	124	160	196	196	196	196	170	145	125	110	97.6	87.4	33.8					

- Note: 1. KW rating when using a one-pitch offset link (OL) is 65% of the above. Two pitch offset links (2POL) can be used at 100% of the above values.
 2. Please contact a Tsubaki representative prior to use of kW ratings in the colored area of the table.

Multi-strand factor	Number of chain strands	Multi-strand factor	Number of chain strands	Multi-strand factor
	Double strand	1.7	Quintuple strand	3.9
	Triple strand	2.5	Sextuple strand	4.6
	Quadruple strand	3.3	-	-

Lubrication method	A	Manual lubrication or drip lubrication	Details on Pg. 202
	B	Oil bath or slinger disc lubrication	
	C	Forced pump lubrication	

RS100 Sprocket

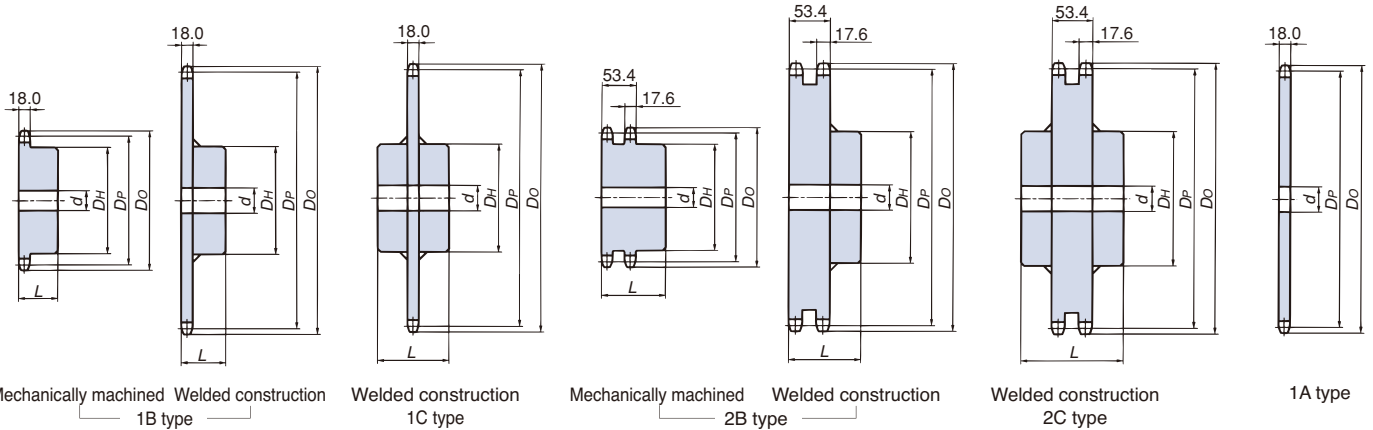

Number of Teeth	Pitch Circular Diameter (Dp)	Sprocket Outer Diameter (Do)	1B type				1C type				2B type				2C type				1A type		Number of Teeth				
			Bore Diameter (d)		Hub		Approx. Mass (kg)	Material	Bore Diameter (d)		Hub		Approx. Mass (kg)	Material	Bore Diameter (d)		Hub		Approx. Mass (kg)	Material		Pitch Diameter (Dp)	Approx. Mass (kg)	Material	
			Pitch Diameter	Maximum	Diameter (Dh)	Length (L)			Pitch Diameter	Maximum	Diameter (Dh)	Length (L)			Pitch Diameter	Maximum	Diameter (Dh)	Length (L)							Pitch Diameter
10	102.75	117	18	43	65	50	1.8	Mechanically machined: machine-structural carbon steel															10		
11	112.70	127	23	50	75	50	2.2																		11
12	122.67	138	23	57	86	50	2.8																		12
13	132.67	148	23	59	88	50	3.1																		13
14	142.68	158	23	59	88	50	3.4																		14
15	152.71	168	28	66	98	50	4.0																		15
16	162.75	179	28	66	98	50	4.3																		16
17	172.79	189	28	75	107	50	5.1																		17
18	182.84	199	28	75	107	50	5.4																		18
19	192.90	209	28	75	107	50	5.8																		19
20	202.96	220	28	75	107	50	6.3																		20
21	213.03	230	28	75	107	50	6.7																		21
22	223.10	240	33	80	117	56	8.1																		22
23	233.17	250	33	80	117	56	8.6																		23
24	243.25	260	33	80	117	56	9.1																		24
25	253.32	270	33	80	117	56	9.6																		25
26	263.41	281	33	80	117	56	10.2																		26
27	273.49	291	33	80	117	56	10.8																		27
28	283.57	301	33	80	117	56	11.4																		28
30	303.75	321	33	80	117	56	12.7																	30	
32	323.92	341	33	80	117	56	14.1																	32	
34	344.10	362	33	89	127	63	16.8																	34	
35	354.20	372	33	89	127	63	17.5																	35	
36	364.29	382	33	89	127	63	18.3																	36	
38	384.48	402	33	89	127	63	20.0																	38	
40	404.67	422	33	89	127	63	21.7																	40	
42	424.86	443	33	89	127	63	23.6																	42	
45	455.15	473	33	89	127	63	26.5																	45	
48	485.45	503	33	89	127	63	29.3																	48	
50	505.65	524	33	89	127	63	31.5																	50	
54	546.05	564	33	103	147	80	39.7																	54	
60	606.66	625	33	103	147	80	47.4																	60	
65	657.17	675	33	103	147	80	54.1																	65	
70	707.68	726	33	103	147	80	61.8																	70	
75	758.20	777	33	103	147	80	70.0																	75	

- Note: 1. Maximum bore diameter is the typical range. Determine bore diameter and key bearing pressure based on general mechanical design
 2. Outer diameters in the table above are for 1B models. Diameters may vary for other models.
 3. Weld specifications: carbon steel for machine structural use or rolled steel for general structural use
 4. Shaded areas indicate hardened teeth specifications.
 5. All other products do not use hardened teeth, although tooth hardening is available upon request. Contact a Tsubaki representative regarding delivery times.
 6. Items with dimensions in thin font are made-to-order. All other items are stocked.
 7. Models in the dimensional chart whose approximate mass is in bold font have one hanging hole. See the diagram on the right for more information.
 8. The dimensions shown in this catalog are nominal dimensions and differ from actual dimensions.

Hanging hole dimensions

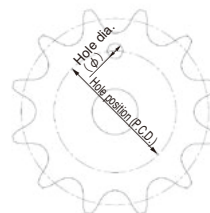

The phase relationship between the hanging hole and teeth may vary.

No. of teeth	1B, 1C, 1A Type bore dia. (φ40) Hole position (P.C.D.)	2B, 2C Type bore dia. (φ35) Hole position (P.C.D.)
32		224
34		245
35		255
36		265
38		285
40		305
42		326
45		356
48	392	386
50	412	407
54	453	447
60	513	508
65	564	
70	614	
75	665	

Model numbering

RS100 -2B 20T Q

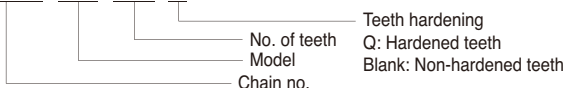

RS120

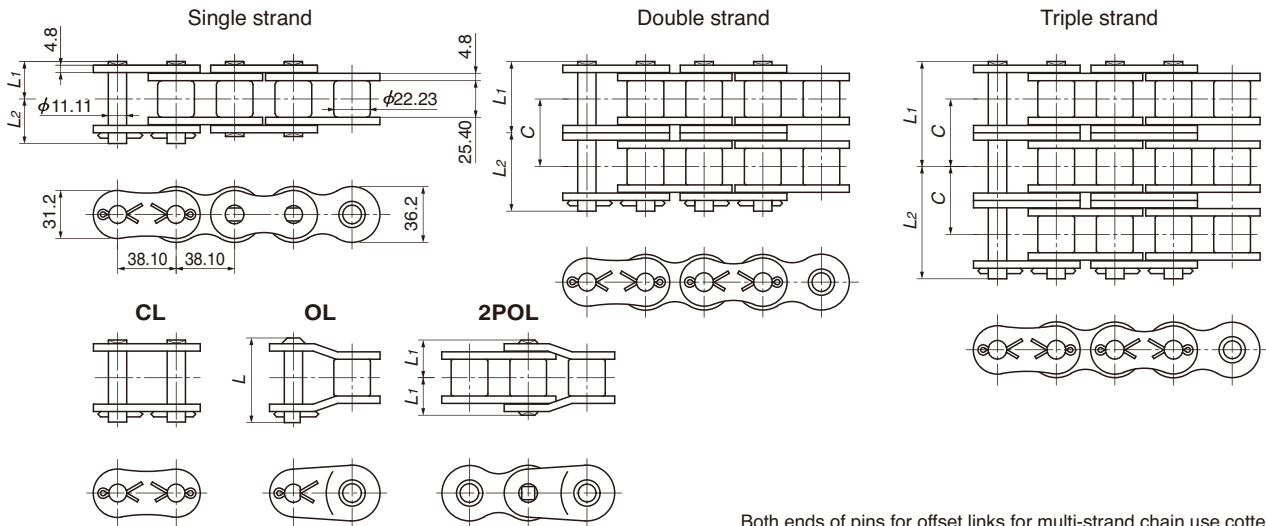

Both ends of pins for offset links for multi-strand chain use cotter pins.

TSUBAKI Chain Number	Number of Strands	Pin Length L ₁ +L ₂	Dimensions L ₁	Dimensions L ₂	Offset Pin Length L	Transverse Pitch C	Pin Type	ANSI Standard Min. Tensile Strength kN{kgf}	Tsubaki Minimum Tensile Strength kN{kgf}	Tsubaki Average Tensile Strength kN{kgf}	Maximum Allowable Load kN{kgf}	Approximate Mass kg/m
RS120-1	1	53.8	24.9	28.9	55.0	45.4	Cotter pin Riveting	125.0{12747}	148{15100}	167{17000}	30.4{3100}	5.93
RS120-2	2	99.2	47.6	51.6	103.2		Cotter pin	250.0{25493}	296{30200}	333{34000}	51.7{5270}	11.70
RS120-3	3	144.8	70.4	74.4	148.6			375.0{38240}	444{45300}	500{51000}	76.0{7750}	17.53
RS120-4	4	190.2	93.1	97.1	194.0			-	592{60400}	667{68000}	100{10230}	23.36
RS120-5	5	235.7	115.85	119.85	239.4			-	740{75500}	834{85000}	119{12090}	29.16
RS120-6	6	281.1	138.55	142.55	284.8			-	888{90600}	1000{102000}	140{14260}	34.96

- Note: 1. Maximum allowable load when using a one-pitch offset link (OL) is 65% of the above. Two pitch offset links (2POL) can be used at 100% of the above values.
 2. Number of links per unit = 80
 3. Items in bold are stocked in units, while other items are made-to-order.
 4. The dimensions shown in this catalog are nominal dimensions and differ from actual dimensions.

■ RS120-1 Maximum Kilowatt Ratings Table (kW Ratings for Single Strand Chain)

Small Sprocket No. of Teeth	Small Sprocket Max rpm																									
	A							B							C											
	10	25	50	100	150	200	300	400	500	600	700	800	900	1000	1100	1200	1300	1400	1500	1600	1700	1800	1900	2000	2100	
9	1.65	3.75	7.00	13.1	18.8	24.4	35.1	41.1	41.1	32.2	25.6	20.9	17.5	15.0	13.0	11.4	10.1	9.04	8.15	7.40	6.76	6.20	5.72	5.30	4.92	
10	1.84	4.21	7.85	14.6	21.1	27.3	39.4	46.1	46.0	37.7	30.0	24.5	20.5	17.5	15.2	13.3	11.8	10.6	9.55	8.67	7.91	7.26	6.70	6.20	5.76	
11	2.04	4.66	8.70	16.2	23.4	30.3	43.6	51.0	51.0	43.5	34.6	28.3	23.7	20.2	17.5	15.4	13.7	12.2	11.0	10.0	9.13	8.38	7.73	7.16		
12	2.24	5.12	9.56	17.8	25.7	33.3	47.9	56.1	56.1	49.6	39.4	32.2	27.0	23.1	20.0	17.5	15.6	13.9	12.6	11.4	10.4	9.55	8.81	8.15		
13	2.45	5.58	10.4	19.4	28.0	36.3	52.3	61.1	61.1	55.9	44.4	36.3	30.5	26.0	22.5	19.8	17.5	15.7	14.2	12.8	11.7	10.8	9.93	9.19		
14	2.65	6.05	11.3	21.1	30.3	39.3	56.6	66.2	66.2	62.5	49.6	40.6	34.0	29.1	25.2	22.1	19.6	17.5	15.8	14.4	13.1	12.0	11.1	6.67		
15	2.86	6.52	12.2	22.7	32.7	42.3	61.0	71.3	71.3	69.3	55.0	45.0	37.7	32.2	27.9	24.5	21.7	19.5	17.5	15.9	14.5	13.3	12.3			
16	3.06	6.99	13.0	24.3	35.0	45.4	65.4	76.5	76.5	76.4	60.6	49.6	41.6	35.5	30.8	27.0	24.0	21.4	19.3	17.5	16.0	14.7	13.6			
17	3.27	7.46	13.9	26.0	37.4	48.5	69.8	83.7	83.7	83.7	66.4	54.3	45.5	38.9	33.7	29.6	26.2	23.5	21.2	19.2	17.5	16.1	14.8			
18	3.47	7.93	14.8	27.6	39.8	51.6	74.3	91.2	91.2	91.2	72.3	59.2	49.6	42.4	36.7	32.2	28.6	25.6	23.1	20.9	19.1	17.5	8.43			
19	3.67	8.41	15.7	29.3	42.2	54.7	78.7	98.9	98.9	98.9	78.4	64.2	53.8	45.9	39.8	35.0	31.0	27.7	25.0	22.7	20.7	19.0				
20	3.86	8.89	16.6	31.0	44.6	57.8	83.2	107	107	107	84.7	69.3	58.1	49.6	43.0	37.7	33.5	30.0	27.0	24.5	22.4	20.5				
21	4.05	9.37	17.5	32.6	47.0	60.9	87.7	114	115	115	91.2	74.6	62.5	53.4	46.3	40.6	36.0	32.2	29.1	26.4	24.1	22.1				
22	4.25	9.85	18.4	34.3	49.4	64.0	92.2	119	123	123	97.7	80.0	67.0	57.2	49.6	43.5	38.6	34.6	31.2	28.3	25.8	12.4				
23	4.44	10.3	19.3	36.0	51.9	67.2	96.8	125	132	132	104	85.5	71.7	61.2	53.0	46.6	41.3	36.9	33.3	30.2	27.6					
24	4.63	10.8	20.2	37.7	54.3	70.3	101	131	140	140	111	91.2	76.4	65.2	56.5	49.6	44.0	39.4	35.5	32.2	29.4					
25	4.83	11.3	21.1	39.4	56.7	73.5	106	137	146	146	118	96.9	81.2	69.3	60.1	52.8	46.8	41.9	37.7	34.3	30.8					
26	5.02	11.8	22.0	41.1	59.2	76.7	110	143	152	152	126	103	86.1	73.5	63.7	55.9	49.6	44.4	40.0	36.3	19.8					
28	5.41	12.8	23.9	44.5	64.1	83.1	120	155	165	165	140	115	96.3	82.2	71.2	62.5	55.5	49.6	44.7	40.6						
30	5.79	13.8	25.7	48.0	69.1	89.5	129	167	178	178	156	127	107	91.2	79.0	69.3	61.5	55.0	49.6	31.6						
32	6.18	14.8	27.6	51.4	74.1	96.0	138	179	191	191	171	140	118	100	87.0	76.4	67.8	60.6	54.7							
35	6.76	16.3	30.4	56.7	81.6	106	152	197	210	210	196	161	135	115	99.6	87.4	77.5	69.3	35.6							
40	7.72	18.8	35.1	65.4	94.3	122	176	228	242	242	240	196	164	140	122	107	94.7	44.4								
45	8.69	21.3	39.8	74.3	107	139	200	259	286	286	286	234	196	167	145	127	59.7									

- Note: 1. KW rating when using a one-pitch offset link (OL) is 65% of the above. Two pitch offset links (2POL) can be used at 100% of the above values.
 2. Please contact a Tsubaki representative prior to use of kW ratings in the colored area of the table.

Multi-strand factor	Number of chain strands	Multi-strand factor	Number of chain strands	Multi-strand factor	Lubrication method	A	Manual lubrication or drip lubrication	Details on Pg. 202
	Double strand	1.7	Quintuple strand	3.9		B	Oil bath or slinger disc lubrication	
	Triple strand	2.5	Sextuple strand	4.6		C	Forced pump lubrication	
	Quadruple strand	3.3	-	-				

Before Use | Standard Roller Chains | Lubrication Type | Heavy Duty Roller Chains | Corrosion Resistant Roller Chains | Specialty Roller Chains | Sprockets | Pin Gear Drives | Accessories | Selection | Handling

RS120 Sprocket

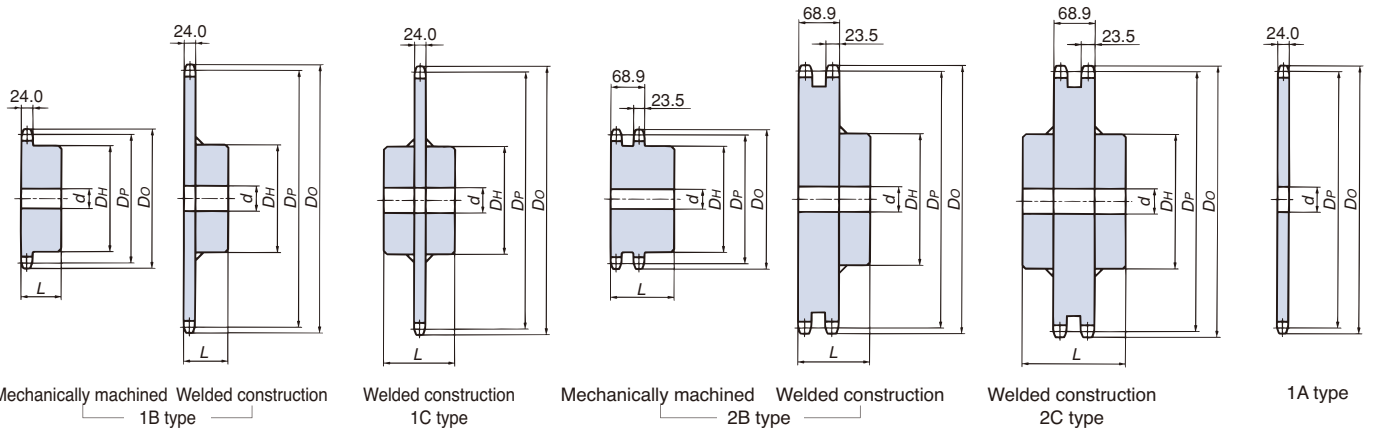

Number of Teeth	Pitch Circular Diameter (DP)	1B type					1C type					2B type					2C type					1A type			Number of Teeth
		Bore Diameter (d)		Hub		Approx. Mass (kg)	Bore Diameter (d)		Hub		Approx. Mass (kg)	Bore Diameter (d)		Hub		Approx. Mass (kg)	Bore Diameter (d)		Hub		Approx. Mass (kg)	First Bore Diameter	Approx. Mass (kg)	Material	
		Pitch Bore Diameter	Maximum	Diameter (DH)	Length (L)		Pitch Bore Diameter	Maximum	Diameter (DH)	Length (L)		Pitch Bore Diameter	Maximum	Diameter (DH)	Length (L)		Pitch Bore Diameter	Maximum	Diameter (DH)	Length (L)					
10	123.29	140	23	51	78	56	3.0																		10
11	135.23	153	28	60	91	56	3.8																		11
12	147.21	165	28	66	98	56	4.5																		12
13	159.20	177	28	66	98	56	5.0																		13
14	171.22	190	28	75	107	56	6.0																		14
15	183.25	202	33	80	117	63	7.4																		15
16	195.29	214	33	80	117	63	8.1																		16
17	207.35	227	33	80	117	63	8.8																		17
18	219.41	239	33	80	117	63	9.5																		18
19	231.48	251	33	80	117	63	10.3																		19
20	243.55	263	33	89	127	63	11.7																		20
21	255.63	276	33	89	127	63	12.5																		21
22	267.72	288	33	89	127	63	13.6																		22
23	279.80	300	33	89	127	63	14.6																		23
24	291.90	312	33	89	127	63	15.6																		24
25	303.99	324	33	89	127	63	16.6																		25
26	316.09	337	33	89	127	63	17.7																		26
27	328.19	349	33	89	127	63	18.8																		27
28	340.29	361	33	103	147	71	22.3																		28
30	364.49	385	33	103	147	71	24.8																		30
32	388.71	410	33	103	147	71	27.4																		32
34	412.93	434	33	103	147	71	30.2																		34
35	425.04	446	33	103	147	71	31.4																		35
36	437.15	458	33	103	147	71	33.0																		36
38	461.37	483	38	103	147	80	37.1																		38
40	485.60	507	38	103	147	80	40.4																		40
42	509.83	531	38	103	147	80	43.9																		42
45	546.19	568	38	103	147	80	49.5																		45
48	582.54	604	38	103	147	80	55.4																		48
50	606.78	628	38	103	147	80	59.6																		50
54	655.26	677	38	110	157	90	71.1																		54
60	727.99	750	38	110	157	90	85.8																		60
65	788.60	811	38	118	167	94	101.2																		65
70	849.22	871	38	118	167	94	115.7																		70
75	909.84	932	38	118	167	94	131.3																		75

- Note: 1. Maximum bore diameter is the typical range. Determine bore diameter and key bearing pressure based on general mechanical design
 2. Outer diameters in the table above are for 1B models. Diameters may vary for other models.
 3. Weld specifications: carbon steel for machine structural use or rolled steel for general structural use
 4. Shaded areas indicate hardened teeth specifications.
 5. All other products do not use hardened teeth, although tooth hardening is available upon request. Contact a Tsubaki representative regarding delivery times.
 6. Items with dimensions in thin font are made-to-order. All other items are stocked.
 7. Models in the dimensional chart whose approximate mass is in bold font have one hanging hole.
 See the diagram on the right for more information.
 8. The dimensions shown in this catalog are nominal dimensions and differ from actual dimensions.

Hanging hole dimensions

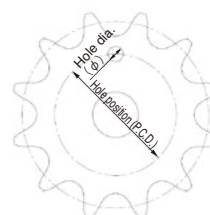

The phase relationship between the hanging hole and teeth may vary.

No. of teeth	1B, 1C, 1A Type bore dia. (φ40) Hole position (P.C.D.)	2B, 2C Type bore dia. (φ35) Hole position (P.C.D.)
30		258
32		382
34		307
35	322	319
36	344	331
38	359	355
40	383	380
42	407	404
45	443	440
48	480	477
50	504	501
54	553	550
60	625	623
65	686	
70	746	
75	807	

Model numbering

RS120 -2B 20T Q

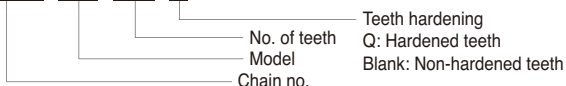

RS140

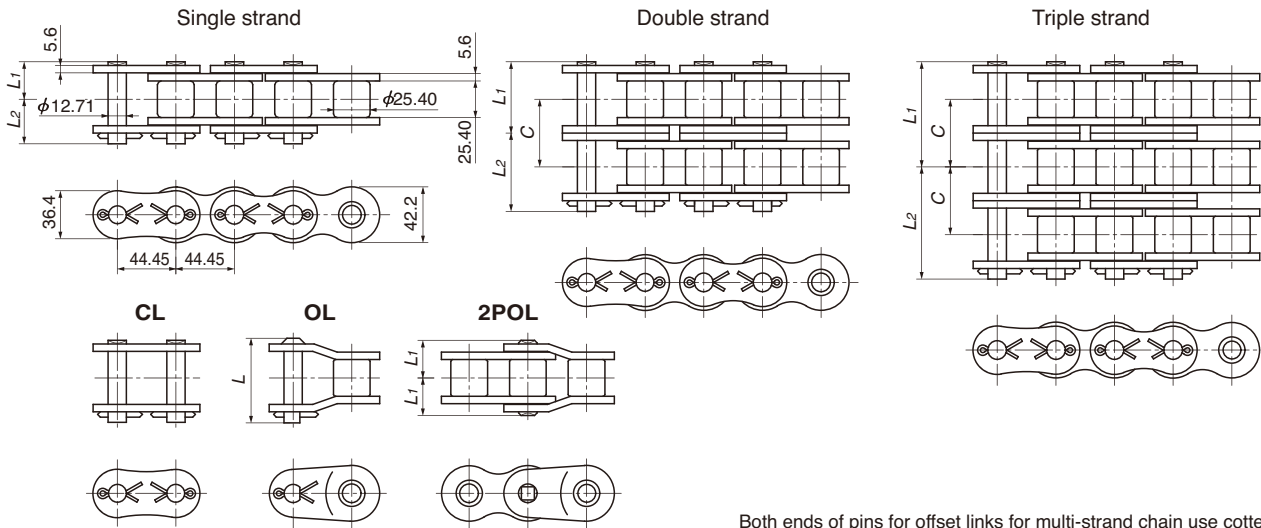

Both ends of pins for offset links for multi-strand chain use cotter pins.

TSUBAKI Chain Number	Number of Strands	Pin Length L ₁ +L ₂	Dimensions L ₁	Dimensions L ₂	Offset Pin Length L	Transverse Pitch C	Pin Type	ANSI Standard Min. Tensile Strength kN{kgf}	Tsubaki Minimum Tensile Strength kN{kgf}	Tsubaki Average Tensile Strength kN{kgf}	Maximum Allowable Load kN{kgf}	Approximate Mass kg/m
RS140-1	1	58.6	26.9	31.7	59.5	48.9	Cotter pin	170.0{17336}	193{19700}	216{22000}	40.2{4100}	7.49
RS140-2	2	107.5	51.35	56.15	112.3			340.0{34671}	386{39400}	431{44000}	68.4{6970}	14.83
RS140-3	3	156.6	75.85	80.75	161.3		Riveting	510.0{52006}	580{59100}	647{66000}	101{10250}	22.20
RS140-4	4	205.5	100.3	105.2	210.2			-	773{78800}	863{88000}	133{13530}	28.52
RS140-5	5	254.4	124.8	129.6	259.1		-	-	966{98500}	1080{110000}	157{15990}	36.97
RS140-6	6	303.5	149.3	154.2	308.0		-	-	1160{118200}	1290{132000}	185{18860}	44.30

- Note: 1. Maximum allowable load when using a one-pitch offset link (OL) is 65% of the above. Two pitch offset links (2POL) can be used at 100% of the above values.
 2. Number of links per unit = 68
 3. Items in bold are stocked in units, while other items are made-to-order.
 4. The dimensions shown in this catalog are nominal dimensions and differ from actual dimensions.

RS140-1 Maximum Kilowatt Ratings Table (kW Ratings for Single Strand Chain)

Small Sprocket No. of Teeth	Small Sprocket Max rpm																							
	10	25	50	100	150	200	250	300	350	400	450	500	550	600	700	800	900	1000	1100	1200	1300	1400	1500	1600
9	2.54	5.79	10.8	20.2	29.0	37.6	46.0	54.2	56.1	56.1	47.9	41.5	36.5	28.9	23.7	19.8	16.9	14.7	12.9	11.4	10.2	9.22	8.37	7.64
10	2.84	6.49	12.1	22.6	32.5	42.2	51.5	60.7	65.6	65.6	56.1	48.7	42.7	33.9	27.7	23.2	19.8	17.2	15.1	13.4	12.0	10.8	9.81	
11	3.15	7.19	13.4	25.0	36.1	46.7	57.1	67.3	72.7	72.7	64.8	56.1	49.3	39.1	32.0	26.8	22.9	19.8	17.4	15.4	13.8	12.5	11.3	
12	3.46	7.90	14.7	27.5	39.6	51.3	62.7	73.9	79.9	79.9	73.8	64.0	56.1	44.5	36.5	30.6	26.1	22.6	19.8	17.6	15.7	14.2	12.9	
13	3.78	8.61	16.1	30.0	43.2	56.0	68.4	80.6	87.1	87.1	83.2	72.1	63.3	50.2	41.1	34.5	29.4	25.5	22.4	19.8	17.8	16.0	14.5	
14	4.09	9.33	17.4	32.5	46.8	60.6	74.1	87.3	94.4	94.4	94.4	93.0	80.6	70.7	56.1	45.9	38.5	32.9	28.5	25.0	22.2	19.8	17.9	16.2
15	4.41	10.1	18.8	35.0	50.4	65.3	79.8	94.1	103	103	103	103	89.4	78.4	62.3	51.0	42.7	36.5	31.6	27.7	24.6	22.0	19.8	
16	4.72	10.8	20.1	37.5	54.1	70.0	85.6	101	114	114	114	114	98.5	86.4	68.6	56.1	47.0	40.2	34.8	30.6	27.1	24.2	21.9	
17	5.04	11.5	21.5	40.1	57.7	74.8	91.4	108	124	124	124	124	108	94.6	75.1	61.5	51.5	44.0	38.1	33.5	29.7	26.6	23.9	
18	5.36	12.2	22.8	42.6	61.4	79.5	97.2	115	132	136	136	136	117	103	81.8	67.0	56.1	47.9	41.5	36.5	32.3	28.9	26.1	
19	5.66	13.0	24.2	45.2	65.1	84.3	103	121	140	144	144	144	127	112	88.7	72.6	60.9	52.0	45.1	39.5	35.1	31.4	28.3	
20	5.96	13.7	25.6	47.8	68.8	89.1	109	128	147	152	152	152	138	121	95.8	78.4	65.7	56.1	48.7	42.7	37.9	33.9		
21	6.25	14.5	27.0	50.3	72.5	93.9	115	135	155	161	161	161	148	130	103	84.4	70.7	60.4	52.3	45.9	40.7	36.5		
22	6.55	15.2	28.4	52.9	76.3	98.8	121	142	163	169	169	169	159	139	111	90.5	75.8	64.8	56.1	49.3	43.7	39.1		
23	6.85	15.9	29.8	55.5	80.0	104	127	149	172	177	177	177	170	149	118	96.7	81.1	69.2	60.0	52.7	46.7	41.8		
24	7.15	16.7	31.2	58.2	83.8	109	133	156	180	186	186	186	181	159	126	103	86.4	73.8	64.0	56.1	49.8	44.5		
25	7.45	17.5	32.6	60.8	87.5	113	139	163	188	194	194	194	192	169	134	110	91.9	78.4	68.0	59.7	52.9	47.4		
26	7.74	18.2	34.0	63.4	91.3	118	145	170	196	204	204	204	204	179	142	116	97.4	83.2	72.1	63.3	56.1			
28	8.34	19.7	36.8	68.7	98.9	128	157	185	212	228	228	228	228	200	159	130	109	93.0	80.6	70.7	62.7			
30	8.93	21.3	39.7	74.0	107	138	169	199	229	253	253	253	253	222	176	144	121	103	89.4	78.4	69.6			
32	9.53	22.8	42.5	79.3	114	148	181	213	245	276	276	276	276	244	194	159	133	114	98.5	86.4				
35	10.4	25.1	46.8	87.4	126	163	199	235	270	304	304	304	304	280	222	182	152	130	113	98.9				
40	11.9	29.0	54.1	101	145	188	230	271	312	351	351	351	351	342	271	222	186	159	133					
45	13.4	32.9	61.4	115	165	214	262	308	354	399	408	408	408	408	323	265	222	177	69.2					

- Note: 1. KW rating when using a one-pitch offset link (OL) is 65% of the above. Two pitch offset links (2POL) can be used at 100% of the above values.
 2. Please contact a Tsubaki representative prior to use of kW ratings in the colored area of the table.

Multi-strand factor	Number of chain strands	Multi-strand factor	Number of chain strands	Multi-strand factor	Lubrication method	A	Manual lubrication or drip lubrication	Details on Pg. 202
	Double strand	1.7	Quintuple strand	3.9		B	Oil bath or slinger disc lubrication	
	Triple strand	2.5	Sextuple strand	4.6		C	Forced pump lubrication	
	Quadruple strand	3.3	-	-				

Before Use | Standard Roller Chains | Lubrication | Heavy Duty Roller Chains | Corrosion Resistant Roller Chains | Specialty Roller Chains | Sprockets | Pin Gear Drives | Accessories | Selection | Handling

RS140 Sprocket

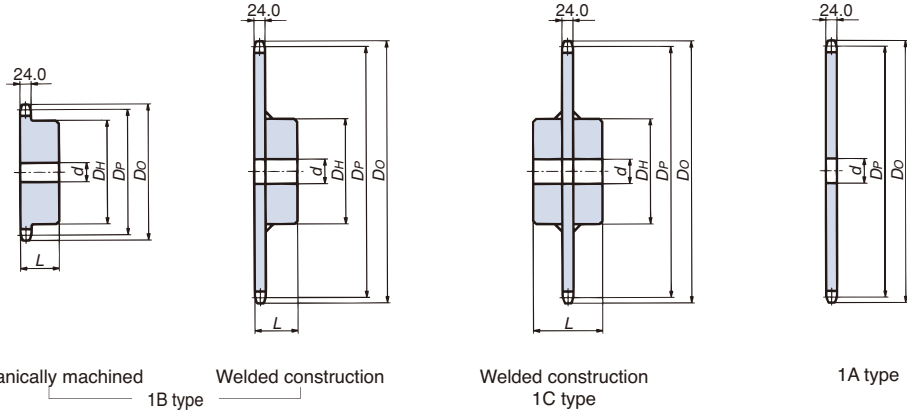

Number of Teeth	Pitch Circular Diameter (D _p)	Sprocket Outer Diameter (D _o)	1B type					1C type					1A type			Number of Teeth		
			Bore Diameter (d)		Hub		Approx. Mass (kg)	Material	Bore Diameter (d)		Hub		Approx. Mass (kg)	Material	Pilot Bore Diameter (d)		Approx. Mass (kg)	Material
			Pilot Bore Diameter	Maximum	Diameter (D _H)	Length (L)			Pilot Bore Diameter	Maximum	Diameter (D _H)	Length (L)						
10	143.84	163	28	60	91	56	4.1	Mechanically machined: machine-structural carbon steel							28	2.6	Machine-structural carbon steel	10
11	157.77	178	33	73	106	56	5.1								33	3.2		11
12	171.74	193	33	80	117	56	6.3							33	3.8	12		
13	185.74	207	33	80	117	63	7.5							33	4.5	13		
14	199.76	221	33	89	127	63	8.9							33	5.3	14		
15	213.79	236	33	89	127	63	9.7							33	6.1	15		
16	227.84	250	33	89	127	63	10.6							33	7.0	16		
17	241.91	264	33	89	127	63	11.5							33	7.9	17		
18	255.98	279	33	89	127	63	12.5							33	9.0	18		
19	270.06	293	33	95	137	71	15.1							33	10.0	19		
20	284.14	307	33	95	137	71	16.2							33	11.1	20		
21	298.24	322	33	95	137	71	17.4							33	12.3	21		
22	312.34	336	33	103	147	71	19.6			33	103	147	115	25.1	33	13.6		22
23	326.44	350	33	103	147	71	21.0			33	103	147	115	26.4	33	14.8		23
24	340.54	364	33	103	147	71	22.3			33	103	147	115	27.7	33	16.2		24
25	354.65	379	38	103	147	80	24.7			38	103	147	115	28.9	38	17.6		25
26	368.77	393	38	103	147	80	26.0			38	103	147	115	30.1	38	18.8		26
27	382.88	407	38	103	147	80	27.6			38	103	147	115	31.7	38	20.3		27
28	397.00	421	38	103	147	80	29.2			38	103	147	115	33.2	38	21.9		28
30	425.24	450	38	103	147	80	32.6		38	103	147	115	36.6	38	25.3	30		
32	453.49	478	38	103	147	80	36.3		38	103	147	115	40.2	38	28.9	32		
34	481.75	506	38	103	147	80	40.1		38	103	147	115	44.0	38	32.7	34		
35	495.88	521	38	110	157	90	44.6		38	110	157	125	49.2	38	34.7	35		
36	510.01	535	38	110	157	90	46.7		38	110	157	125	51.2	38	36.8	36		
38	538.27	563	38	110	157	90	51.1		38	110	157	125	55.5	38	41.1	38		
40	566.54	591	38	110	157	90	55.6		38	118	167	130	62.9	38	45.6	40		
42	594.81	620	38	118	167	94	62.3		38	118	167	130	67.6	38	50.4	42		
45	637.22	662	38	118	167	94	70.0		38	118	167	130	75.2	38	58.0	45		
48	679.63	705	38	118	167	94	78.3		38	118	167	130	83.4	38	66.1	48		
50	707.91	733	38	118	167	94	84.0		38	118	167	130	89.1	38	71.8	50		
54	764.47	790	38	118	167	94	96.7		38	118	167	130	101.2	38	84.0	54		
60	849.32	875	38	118	167	94	116.6		38	118	167	155	125.2	38	103.9	60		

- Note: 1. Maximum bore diameter is the typical range. Determine bore diameter and key bearing pressure based on general mechanical design
 2. Outer diameters in the table above are for 1B models. Diameters may vary for other models.
 3. Weld specifications: carbon steel for machine structural use or rolled steel for general structural use
 4. Shaded areas indicate hardened teeth specifications.
 5. All other products do not use hardened teeth, although tooth hardening is available upon request. Contact a Tsubaki representative regarding delivery times.
 6. Items with dimensions in thin font are made-to-order. All other items are stocked.
 7. Models in the dimensional chart whose approximate mass is in bold font have one hanging hole. See the diagram on the right for more information.
 8. The dimensions shown in this catalog are nominal dimensions and differ from actual dimensions.

Hanging hole dimensions

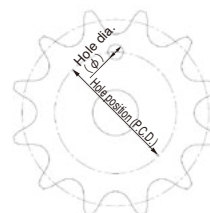

The phase relationship between the hanging hole and teeth may vary.

No. of teeth	1B, 1C, 1A Type bore dia. (φ40) Hole position (P.C.D.)
26	263
27	277
28	291
30	319
32	348
34	376
35	390
36	404
38	432
40	461
42	489
45	531
48	574
50	602
54	659
60	743

Model numbering

RS140 -1B 30T Q

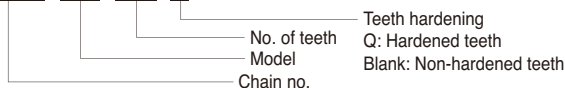

RS160

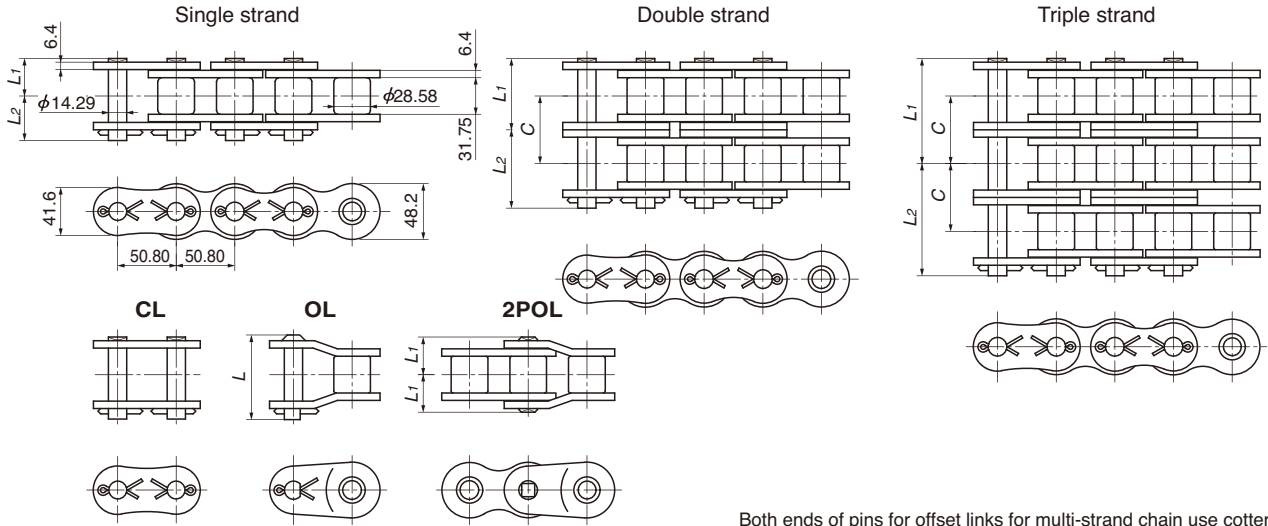

Both ends of pins for offset links for multi-strand chain use cotter pins.

Tsubaki Chain Number	Number of Strands	Pin Length L ₁ +L ₂	Dimensions L ₁	Dimensions L ₂	Offset Pin Length L	Transverse Pitch C	Pin Type	ANSI Standard Min. Tensile Strength kN{kgf}	Tsubaki Minimum Tensile Strength kN{kgf}	Tsubaki Average Tensile Strength kN{kgf}	Maximum Allowable Load kN{kgf}	Approximate Mass kg/m
RS160-1	1	68.7	31.85	36.85	70.2	58.5	Cotter pin	223.0{22740}	255 {26000}	279 {28500}	53.0{5400}	10.10
RS160-2	2	127.3	61.15	66.15	132.2			446.0{45480}	510 {52000}	559 {57000}	90.0{9180}	20.04
RS160-3	3	185.9	90.45	95.45	190.7			669.0{68220}	765 {78000}	838 {85500}	132{13500}	30.02
RS160-4	4	244.4	119.75	124.65	249.2			-	1020{104000}	1120{114000}	175{17820}	40.06
RS160-5	5	303.0	149.05	153.95	307.7			-	1270{130000}	1400{142500}	207{21060}	49.89
RS160-6	6	361.6	178.3	183.3	366.2			-	1530{156000}	1680{171000}	244{24840}	59.93

- Note: 1. Maximum allowable load when using a one-pitch offset link (OL) is 65% of the above. Two pitch offset links (2POL) can be used at 100% of the above values.
 2. Number of links per unit = 60
 3. Items in bold are stocked in units, while other items are made-to-order.
 4. The dimensions shown in this catalog are nominal dimensions and differ from actual dimensions.

RS160-1 Maximum Kilowatt Ratings Table (kW Ratings for Single Strand Chain)

Small Sprocket No. of Teeth	Small Sprocket Max rpm																							
	A						B						C											
	10	25	50	100	150	200	250	300	350	400	450	500	550	600	650	700	750	800	850	900	1000	1100	1200	1300
9	3.82	8.72	16.3	30.4	43.8	56.7	69.3	74.5	74.5	74.5	62.5	53.3	46.2	40.6	36.0	32.2	29.0	26.4	24.1	22.1	18.9	16.3	14.3	12.7
10	4.29	9.78	18.2	34.0	49.0	63.5	77.6	87.3	87.3	87.3	73.2	62.5	54.1	47.5	42.1	37.7	34.0	30.9	28.2	25.9	22.1	19.1	16.8	14.9
11	4.75	10.8	20.2	37.7	54.3	70.4	86.1	98.5	98.5	98.5	84.4	72.1	62.5	54.8	48.6	43.5	39.2	35.6	32.5	29.8	25.5	22.1	19.4	17.2
12	5.22	11.9	22.2	41.4	59.7	77.3	94.5	108	108	108	96.2	82.1	71.2	62.5	55.4	49.6	44.7	40.6	37.0	34.0	29.0	25.2	22.1	19.6
13	5.69	13.0	24.2	45.2	65.1	84.3	103	118	118	118	108	92.6	80.2	70.4	62.5	55.9	50.4	45.7	41.8	38.3	32.7	28.4	24.9	22.1
14	6.16	14.1	26.2	49.0	70.5	91.4	112	128	128	128	121	103	89.7	78.7	69.8	62.5	56.3	51.1	46.7	42.8	36.6	31.7	27.8	24.7
15	6.64	15.1	28.3	52.7	76.0	98.4	120	138	138	138	134	115	99.5	87.3	77.4	69.3	62.5	56.7	51.8	47.5	40.6	35.2	30.9	
16	7.12	16.2	30.3	56.6	81.5	106	129	148	148	148	148	126	110	96.2	85.3	76.3	68.8	62.5	57.0	52.3	44.7	38.7	34.0	
17	7.60	17.3	32.4	60.4	87.0	113	138	162	162	162	162	138	120	105	93.4	83.6	75.4	68.4	62.5	57.3	48.9	42.4	37.2	
18	8.08	18.4	34.4	64.2	92.5	120	146	173	177	177	177	151	131	115	102	91.1	82.1	74.5	68.1	62.5	53.3	46.2	40.6	
19	8.53	19.6	36.5	68.1	98.1	127	155	183	192	192	192	164	142	124	110	98.8	89.0	80.8	73.8	67.7	57.8	50.1	44.0	
20	8.97	20.7	38.6	72.0	104	134	164	193	207	207	207	177	153	134	119	107	96.2	87.3	79.7	73.2	62.5	54.1	47.5	
21	9.42	21.8	40.6	75.9	109	142	173	204	220	220	220	190	165	145	128	115	103	93.9	85.8	78.7	67.2	58.3	51.1	
22	9.87	22.9	42.7	79.8	115	149	182	214	231	231	231	204	177	155	138	123	111	101	92.0	84.4	72.1	62.5		
23	10.3	24.0	44.8	83.7	121	156	191	225	243	243	243	218	189	166	147	132	119	108	98.3	90.2	77.0	66.8		
24	10.8	25.2	47.0	87.6	126	164	200	236	254	254	254	232	201	177	157	140	126	115	105	96.2	82.1	71.2		
25	11.2	26.3	49.1	91.6	132	171	209	246	266	266	266	247	214	188	167	149	134	122	111	102	87.3	75.4		
26	11.7	27.4	51.2	95.5	138	178	218	257	277	277	277	262	227	199	177	158	143	129	118	108	92.6	80.2		
28	12.6	29.7	55.5	103	149	193	236	278	300	300	300	293	254	223	197	177	159	145	132	121	103	89.7		
30	13.5	32.0	59.8	112	161	208	254	300	325	325	325	325	281	247	219	196	177	160	146	134	115			
32	14.4	34.3	64.1	120	172	223	273	321	358	358	358	358	310	272	241	216	195	177	161	148	126			
35	15.7	37.8	70.6	132	190	246	300	354	407	409	409	409	354	311	276	247	223	202	185	169	134			
40	17.9	43.7	81.5	152	219	284	347	409	470	485	485	485	433	380	337	302	272	247	225	192				
45	20.2	49.6	92.6	173	249	322	394	464	533	551	551	551	517	454	402	360	312	260	202	141				

- Note: 1. KW rating when using a one-pitch offset link (OL) is 65% of the above. Two pitch offset links (2POL) can be used at 100% of the above values.
 2. Please contact a Tsubaki representative prior to use of kW ratings in the colored area of the table.

Multi-strand factor	Number of chain strands	Multi-strand factor	Number of chain strands	Multi-strand factor
	Double strand	1.7	Quintuple strand	3.9
	Triple strand	2.5	Sextuple strand	4.6
	Quadruple strand	3.3	-	-

Lubrication method	A	Manual lubrication or drip lubrication	Details on Pg. 202
	B	Oil bath or slinger disc lubrication	
	C	Forced pump lubrication	

Before Use
 Standard Roller Chains
 Lubrication-Free Roller Chains
 Heavy Duty Roller Chains
 Corrosion Resistant Roller Chains
 Specialty Roller Chains
 Sprockets
 Pin Gear Drives
 Accessories
 Selection
 Handling

RS160 Sprocket

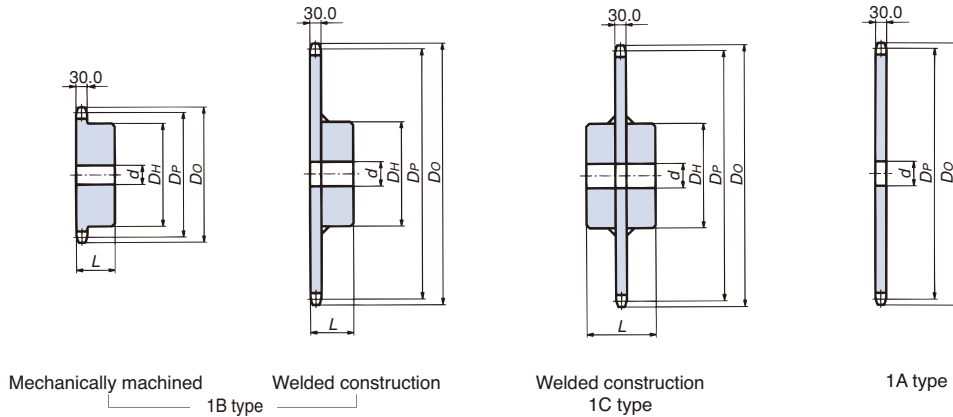

Number of Teeth	Pitch Circular Diameter (D _p)	Sprocket Outer Diameter (D _o)	1B type					1C type					1A type			Number of Teeth		
			Bore Diameter (d)		Hub		Approx. Mass (kg)	Material	Bore Diameter (d)		Hub		Approx. Mass (kg)	Material	Pilot Bore Diameter (d)		Approx. Mass (kg)	Material
			Pilot Bore Diameter	Maximum	Diameter (D _H)	Length (L)			Pilot Bore Diameter	Maximum	Diameter (D _H)	Length (L)						
10	164.39	187	33	70	105	63	6.3	Mechanically machined: machine-structural carbon steel							33	4.3	Machine-structural carbon steel	10
11	180.31	203	33	80	117	63	7.8								33	5.3		11
12	196.28	220	33	89	127	63	9.4								33	6.3		12
13	212.27	237	33	95	137	71	11.9								33	7.5		13
14	228.29	253	33	95	137	71	13.2								33	8.8		14
15	244.33	269	33	95	137	71	14.5								33	10.1		15
16	260.39	286	33	103	147	71	16.7								33	11.6		16
17	276.46	302	33	103	147	71	18.2								33	13.1		17
18	292.55	319	33	103	147	71	19.9								33	14.8		18
19	308.64	335	33	103	147	71	21.6								33	16.5		19
20	324.74	351	33	103	147	71	23.4								33	18.3		20
21	340.84	368	33	103	147	71	25.4								33	20.3		21
22	356.96	384	38	118	167	80	30.6			38	118	167	125	37.8	38	22.2		22
23	373.07	400	38	118	167	80	32.4			38	118	167	125	39.6	38	24.0		23
24	389.19	416	38	118	167	80	34.6			38	118	167	125	41.8	38	26.2		24
25	405.32	433	38	118	167	80	37.0			38	118	167	125	44.2	38	28.6		25
26	421.45	449	38	118	167	80	39.5			38	118	167	125	46.6	38	31.0		26
27	437.58	465	38	118	167	80	42.0			38	118	167	125	49.1	38	33.5		27
28	453.72	481	38	118	167	80	44.6			38	118	167	125	51.7	38	36.1		28
30	485.99	514	38	118	167	100	53.5		38	118	167	125	57.2	38	41.6	30		
32	518.28	546	38	118	167	100	59.5		38	118	167	125	63.0	38	47.4	32		
34	550.57	579	38	118	167	100	65.8		38	118	167	125	69.3	38	53.7	34		
35	566.72	595	38	118	167	100	69.2		38	118	167	135	74.2	38	57.0	35		
36	582.86	611	38	118	167	100	72.6		38	118	167	135	77.6	38	60.3	36		
38	615.17	644	38	118	167	100	80.1		38	118	167	135	84.6	38	67.4	38		
40	647.47	676	38	132	187	121	94.4		38	132	187	150	99.7	38	74.8	40		
42	679.78	708	38	132	187	121	102.2		38	132	187	150	107.5	38	82.6	42		
45	728.25	757	38	132	187	121	115.2		38	132	187	150	119.9	38	95.0	45		
48	776.72	806	38	132	187	121	128.5		38	132	187	150	133.2	38	108.4	48		
50	809.04	838	38	132	187	121	137.9		38	132	187	150	142.5	38	117.7	50		
54	873.68	903	38	132	187	121	157.7		38	132	187	150	162.4	38	137.5	54		
60	970.65	1000	38	132	187	121	190.7		38	132	187	160	197.0	38	170.1	60		

- Note: 1. Maximum bore diameter is the typical range. Determine bore diameter and key bearing pressure based on general mechanical design
 2. Outer diameters in the table above are for 1B models. Diameters may vary for other models.
 3. Weld specifications: carbon steel for machine structural use or rolled steel for general structural use
 4. Shaded areas indicate hardened teeth specifications.
 5. All other products do not use hardened teeth, although tooth hardening is available upon request. Contact a Tsubaki representative regarding delivery times.
 6. Items with dimensions in thin font are made-to-order. All other items are stocked.
 7. Models in the dimensional chart whose approximate mass is in bold font have one hanging hole.
 See the diagram on the right for more information.
 8. The dimensions shown in this catalog are nominal dimensions and differ from actual dimensions.

Hanging hole dimensions

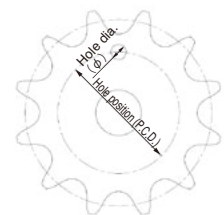

The phase relationship between the hanging hole and teeth may vary.

No. of teeth	1B, 1C, 1A Type bore dia. (φ40) Hole position (P.C.D.)	No. of teeth	1B, 1C, 1A Type bore dia. (φ40) Hole position (P.C.D.)
23	261	36	471
24	277	38	503
25	293	40	535
26	309	42	568
27	326	45	616
28	342	48	665
30	374	50	697
32	406	54	762
34	438	60	859
35	455		

Model numbering

RS160 -1B 30T Q

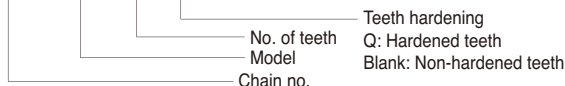

RS180

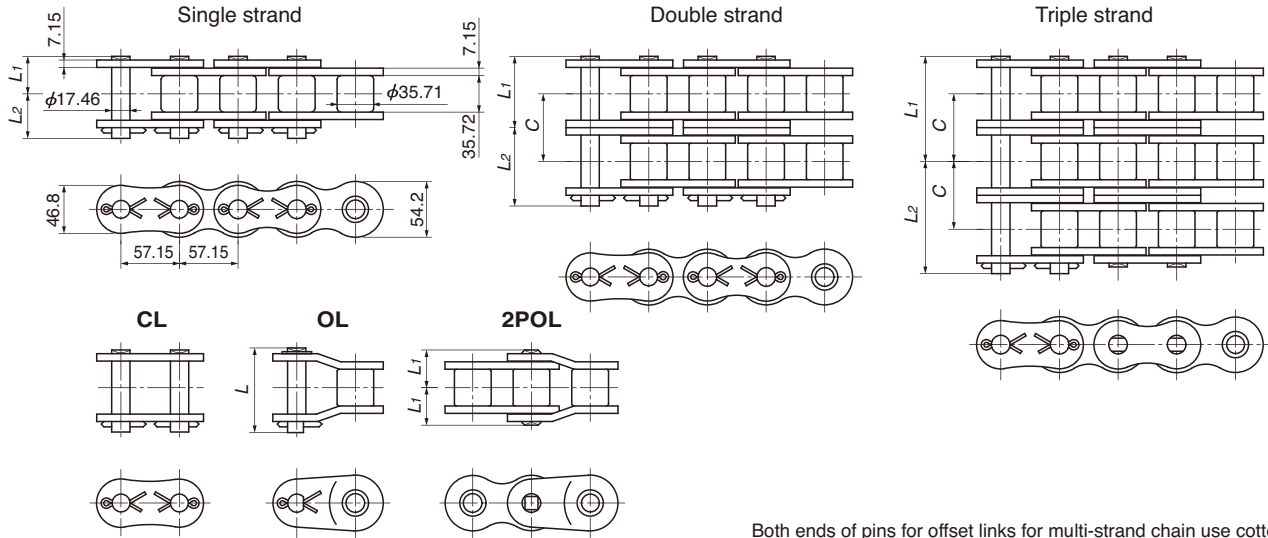

Both ends of pins for offset links for multi-strand chain use cotter pins.

TSUBAKI Chain Number	Number of Strands	Pin Length L1+L2	Dimensions L1	Dimensions L2	Offset Pin Length L	Transverse Pitch C	Pin Type	ANSI Standard Min. Tensile Strength kN{kgf}	Tsubaki Minimum Tensile Strength kN{kgf}	Tsubaki Average Tensile Strength kN{kgf}	Maximum Allowable Load kN{kgf}	Approximate Mass kg/m
RS180-1	1	78.1	35.65	42.45	80.6	65.8	Cotter pin	281.0{28655}	336 {34300}	370 {37700}	60.8{6200}	13.45
RS180-2	2	144.1	68.75	75.35	151.1			562.0{57309}	673 {68600}	739 {75400}	103{10540}	26.52
RS180-3	3	210.2	101.7	108.5	216.9		Riveting	843.0{85963}	1010{102900}	1110{113100}	152{15500}	38.22
RS180-4	4	276.1	134.65	141.45	282.8			-	1350{137200}	1480{150800}	201{20460}	50.90
RS180-5	5	342.0	167.6	174.4	348.6			-	1680{171500}	1850{188500}	237{24180}	63.59
RS180-6	6	407.9	200.55	207.35	414.4			-	2020{205800}	2220{226200}	280{28520}	76.27

Note: 1. Maximum allowable load when using a one-pitch offset link (OL) is 65% of the above. Two pitch offset links (2POL) can be used at 100% of the above values.
 2. Number of links per unit = 54
 3. Items in bold are stocked in units, while other items are made-to-order.
 4. The dimensions shown in this catalog are nominal dimensions and differ from actual dimensions.

■ RS180-1 Maximum Kilowatt Ratings Table (kW Ratings for Single Strand Chain)

Lubrication Type Small Sprocket No. of Teeth	Small Sprocket Max rpm																							
	10	25	50	100	150	200	250	300	350	400	450	500	550	600	650	700	750	800	850	900	950	1000	1050	1100
9	4.94	11.3	21.0	39.2	56.5	73.2	89.4	90.8	81.9	68.6	58.6	50.8	44.6	39.5	35.4	31.9	29.0	26.4	24.3	22.4	20.7	19.3	18.0	
10	5.53	12.6	23.5	43.9	63.3	82.0	100	102	102	95.9	80.4	68.6	59.5	52.2	46.3	41.4	37.4	33.9	31.0	28.4	26.2	24.3	22.6	21.0
11	6.13	14.0	26.1	48.7	70.1	90.9	111	113	113	111	92.7	79.2	68.6	60.2	53.4	47.8	43.1	39.1	35.7	32.8	30.2	28.0	26.0	24.3
12	6.73	15.4	28.7	53.5	77.0	99.8	122	126	126	126	106	90.2	78.2	68.6	60.9	54.5	49.1	44.6	40.7	37.4	34.4	31.9	29.6	27.6
13	7.34	16.7	31.3	58.3	84.0	109	133	142	142	142	119	102	88.2	77.4	68.6	61.4	55.4	50.3	45.9	42.1	38.8	36.0	33.4	
14	7.95	18.1	33.9	63.2	91.0	118	144	159	159	159	133	114	98.5	86.5	76.7	68.6	61.9	56.2	51.3	47.1	43.4	40.2	37.4	
15	8.57	19.5	36.5	68.1	98.0	127	155	176	176	176	148	126	109	95.9	85.1	76.1	68.6	62.3	56.9	52.2	48.1	44.6	41.4	
16	9.19	21.0	39.1	73.0	105	136	166	191	191	191	163	139	120	106	93.7	83.9	75.6	68.6	62.7	57.5	53.0	49.1	45.6	
17	9.81	22.4	41.8	77.9	112	145	178	201	201	201	178	152	132	116	103	91.8	82.8	75.2	68.6	63.0	58.1	53.8		
18	10.4	23.8	44.4	82.9	119	155	189	216	216	216	194	166	144	126	112	100	90.2	81.9	74.8	68.6	63.3	58.6		
19	11.0	25.2	47.1	87.9	127	164	200	229	229	229	211	180	156	137	121	109	97.8	88.8	81.1	74.4	68.6	63.5		
20	11.6	26.7	49.8	92.9	134	173	212	243	243	243	227	194	168	148	131	117	106	95.9	87.6	80.4	74.1	68.6		
21	12.2	28.1	52.5	97.9	141	183	223	256	256	256	245	209	181	159	141	126	114	103	94.2	86.5	79.7	73.8		
22	12.7	29.6	55.2	103	148	192	235	269	269	269	262	224	194	170	151	135	122	111	101	92.7	85.5			
23	13.3	31.0	57.9	108	156	202	246	282	282	282	280	239	208	182	162	145	130	118	108	99.1	91.4			
24	13.9	32.5	60.6	113	163	211	258	299	299	299	299	255	221	194	172	154	139	126	115	106	97.4			
25	14.5	33.9	63.3	118	170	221	270	318	318	318	318	271	235	206	183	164	148	134	122	112	104			
26	15.1	35.4	66.1	123	178	230	281	331	337	337	337	288	249	219	194	174	157	142	130	119				
28	16.2	38.4	71.6	134	192	249	305	359	377	377	377	322	279	245	217	194	175	159	145	133				
30	17.4	41.3	77.1	144	207	269	328	387	418	418	418	357	309	271	241	215	194	176	161	148				
32	18.5	44.3	82.7	154	222	288	352	415	448	448	448	393	341	299	265	237	214	194	177					
35	20.3	48.8	91.1	170	245	317	388	457	494	494	494	449	390	342	303	271	245	217	164					
40	23.2	56.4	105	196	283	366	448	504	504	504	504	463	429	391	347	297	242	182						
45	26.1	64.0	119	223	321	416	509	551	551	551	507	471	431	383	329	269	202							

Note: 1. kW rating when using a one-pitch offset link (OL) is 65% of the above. Two pitch offset links (2POL) can be used at 100% of the above values.
 2. Please contact a Tsubaki representative prior to use of kW ratings in the colored area of the table.

Multi-strand factor	Number of chain strands	Multi-strand factor	Number of chain strands	Multi-strand factor	Lubrication method	A	Manual lubrication or drip lubrication	Details on Pg. 202
	Double strand	1.7	Quintuple strand	3.9		B	Oil bath or slinger disc lubrication	
	Triple strand	2.5	Sextuple strand	4.6		C	Forced pump lubrication	
	Quadruple strand	3.3	-	-				

RS180 Sprocket

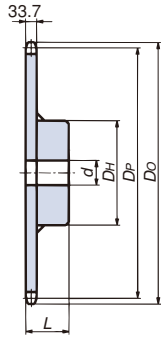

Welded construction
1B type

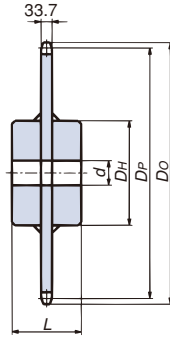

Welded construction
1C type



1A type

Number of Teeth	Pitch Circular Diameter (D _P)	Sprocket Outer Diameter (D _O)	1B type					1C type					1A type			Number of Teeth				
			Bore Diameter (d)		Hub		Approx. Mass (kg)	Material	Bore Diameter (d)		Hub		Approx. Mass (kg)	Material	Pilot Bore Diameter (d)		Approx. Mass (kg)	Material		
			Pilot Bore Diameter	Maximum	Diameter (D _H)	Length (L)			Pilot Bore Diameter	Maximum	Diameter (D _H)	Length (L)								
11	202.85	229	43	75	110	55	8.6													11
12	220.81	248	43	85	130	65	11.6													12
13	238.81	266	43	95	150	75	15.6													13
14	256.83	285	43	105	170	80	19.7													14
15	274.87	303	43	110	180	80	22.6													15
16	292.94	322	43	110	180	80	24.6													16
17	311.02	340	43	115	180	80	26.8													17
18	329.12	358	43	115	180	80	29.2													18
19	347.21	377	43	115	180	80	31.6													19
20	365.33	395	43	115	180	80	34.2													20
21	383.45	413						63	120	190	85	37.8		63						21
22	401.57	432						63	120	190	85	40.4		63						22
23	419.70	450						63	120	200	90	45.7		63						23
24	437.84	468						63	125	200	90	48.8		63						24
25	455.99	487						63	125	200	90	52.0		63						25
26	474.13	505						63	125	200	90	55.4		63						26
27	492.28	523						63	125	200	90	58.9		63						27
28	510.43	542						63	125	200	90	62.6		63						28
30	546.74	578						63	135	220	110	78.7		63						30
32	583.06	615						63	135	220	110	86.9		63						32
34	619.39	651						63	135	220	110	95.8		63						34
35	637.55	669						63	135	220	110	100.4		63						35
36	655.72	688						63	135	220	110	105.1		63						36
38	692.06	724						63	135	220	110	115.0		63						38
40	728.41	760						63	150	240	125	134.7		63						40
42	764.75	797						63	150	240	125	145.8		63						42
45	819.28	852						63	150	240	125	163.3		63						45
48	873.81	906						63	150	240	125	182.1		63						48
50	910.17	943						63	150	240	125	195.3		63						50
54	982.89	1016						63	150	240	125	223.3		63						54
60	1091.98	1125						63	150	240	125	269.5		63						60

Welded construction: machine-structural carbon steel (teeth) and structural rolled steel (hub)

Welded construction: machine-structural carbon steel (teeth) and structural rolled steel (hub)

Welded construction: structural rolled steel (teeth and hub)

Machine-structural carbon steel

- Note: 1. Maximum bore diameter is the typical range. Determine bore diameter and key bearing pressure based on general mechanical design
 2. Outer diameters in the table above are for 1B models. Diameters may vary for other models.
 3. Made-to-order item
 4. The dimensions shown in this catalog are nominal dimensions and differ from actual dimensions.

Hanging hole dimensions

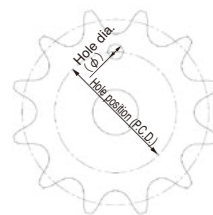

The phase relationship between the hanging hole and teeth may vary.

No. of teeth	1B, 1C, 1A Type bore dia. (φ40)		No. of teeth	1B, 1C, 1A Type bore dia. (φ40)	
	Hole position (P.C.D.)			Hole position (P.C.D.)	
22	276		35	512	
23	294		36	531	
24	313		38	567	
25	331		40	603	
26	349		42	640	
27	367		45	694	
28	385		48	749	
30	422		50	785	
32	458		54	858	
34	464		60	967	

Model numbering

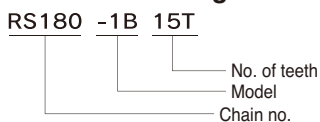

RS200

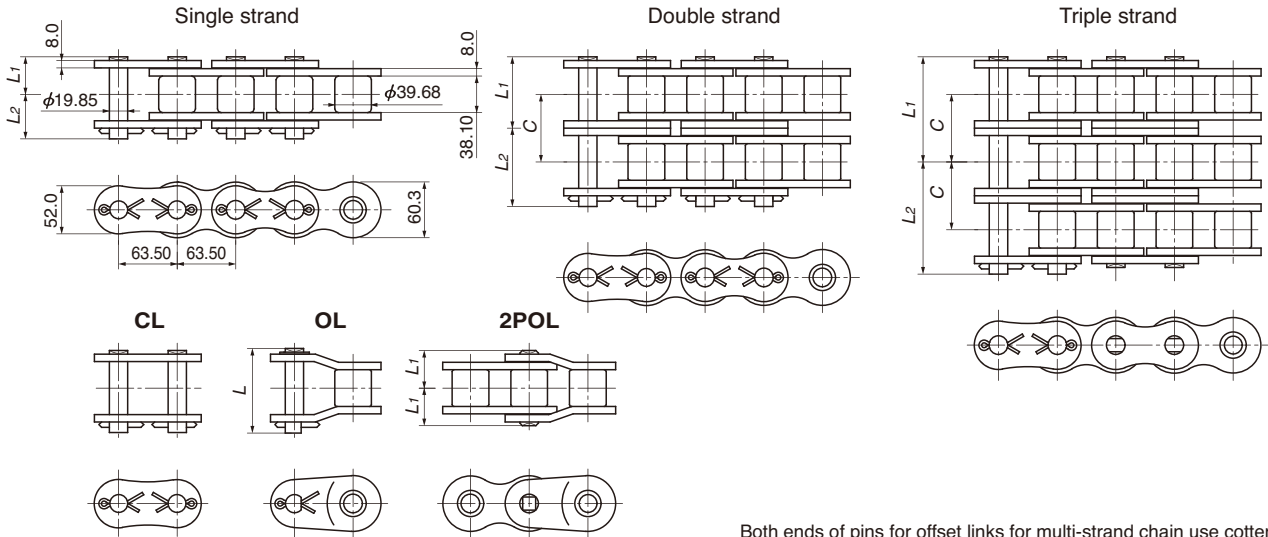

Both ends of pins for offset links for multi-strand chain use cotter pins.

TSUBAKI Chain Number	Number of Strands	Pin Length L ₁ +L ₂	Dimensions L ₁	Dimensions L ₂	Offset Pin Length L	Transverse Pitch C	Pin Type	ANSI Standard Min. Tensile Strength kN{kgf}	Tsubaki Minimum Tensile Strength kN{kgf}	Tsubaki Average Tensile Strength kN{kgf}	Maximum Allowable Load kN{kgf}	Approximate Mass kg/m
RS200-1	1	83.8	39.0	44.8	87.3	71.6	Cotter pin	347.0 {35385}	427 {43500}	471 {48000}	71.6{7300}	16.49
RS200-2	2	155.5	74.85	80.65	161.2			694.0 {70769}	853 {87000}	941 {96000}	122{12410}	32.63
RS200-3	3	227.2	110.75	116.45	233.0		Riveting	1041.0{106153}	1280{130500}	1410{144000}	179{18250}	49.02
RS200-4	4	298.9	146.6	152.3	304.7			—	1710{174000}	1880{192000}	236{24090}	65.16
RS200-5	5	370.6	182.4	188.2	376.3		—	—	2130{217500}	2350{240000}	279{28470}	81.32
RS200-6	6	442.3	218.25	224.05	448.0		—	—	2560{261000}	2820{288000}	329{33580}	97.59

- Note: 1. Maximum allowable load when using a one-pitch offset link (OL) is 65% of the above. Two pitch offset links (2POL) can be used at 100% of the above values.
 2. Number of links per unit = 48
 3. Items in bold are stocked in units, while other items are made-to-order.
 4. The dimensions shown in this catalog are nominal dimensions and differ from actual dimensions.

RS200-1 Maximum Kilowatt Ratings Table (kW Ratings for Single Strand Chain)

Lubrication Type Small Sprocket No. of Teeth	Small Sprocket Max rpm																		
	10	15	20	30	40	50	70	100	150	200	250	300	350	400	450	500	550	600	650
	A					B					C								
9	6.46	9.30	12.1	17.4	22.5	27.5	37.2	51.3	73.9	95.7	108	108	108	89.1	74.7	63.8	55.3	48.5	43.0
10	7.24	10.4	13.5	19.5	25.2	30.8	41.7	57.5	82.8	107	122	122	122	104	87.5	74.7	64.7	56.8	50.4
11	8.02	11.6	15.0	21.6	27.9	34.1	46.2	63.7	91.8	119	135	135	135	120	101	86.1	74.7	65.5	58.1
12	8.81	12.7	16.4	23.7	30.7	37.5	50.8	70.0	101	131	148	148	148	137	115	98.2	85.1	74.7	
13	9.61	13.8	17.9	25.8	33.5	40.9	55.4	76.3	110	142	161	161	161	155	130	111	95.9	84.2	
14	10.4	15.0	19.4	28.0	36.2	44.3	60.0	82.7	119	154	175	175	175	173	145	124	107	94.1	
15	11.2	16.2	20.9	30.1	39.0	47.7	64.6	89.1	128	166	192	192	192	192	161	137	119	104	
16	12.0	17.3	22.4	32.3	41.9	51.2	69.3	95.5	138	178	211	211	211	211	177	151	131	115	
17	12.8	18.5	24.0	34.5	44.7	54.6	74.0	102	147	190	231	231	231	231	194	166	143	126	
18	13.6	19.7	25.5	36.7	47.5	58.1	78.7	108	156	202	247	252	252	252	211	180	156	137	
19	14.4	20.8	27.0	38.9	50.4	61.6	83.4	115	166	215	262	273	273	273	229	196	170	149	
20	15.2	22.0	28.5	41.1	53.3	65.1	88.2	122	175	227	277	290	290	290	247	211	183		
21	15.9	23.2	30.1	43.3	56.2	68.6	92.9	128	185	239	292	305	305	305	266	227	197		
22	16.7	24.4	31.6	45.6	59.0	72.2	97.7	135	194	251	307	321	321	321	285	244	211		
23	17.4	25.6	33.2	47.8	62.0	75.7	103	141	204	264	322	337	337	337	305	260	226		
24	18.2	26.8	34.8	50.1	64.9	79.3	107	148	213	276	338	353	353	353	325	278	241		
25	18.9	28.0	36.3	52.3	67.8	82.9	112	155	223	289	353	369	369	369	346	295	256		
26	19.7	29.3	37.9	54.6	70.7	86.5	117	161	232	301	368	385	385	385	367	313	271		

- Note: 1. KW rating when using a one-pitch offset link (OL) is 65% of the above. Two pitch offset links (2POL) can be used at 100% of the above values.
 2. Please contact a Tsubaki representative prior to use of kW ratings in the colored area of the table.

Multi-strand factor	Number of chain strands	Multi-strand factor	Number of chain strands	Multi-strand factor
	Double strand	1.7	Quintuple strand	3.9
	Triple strand	2.5	Sextuple strand	4.6
	Quadruple strand	3.3	—	—

Lubrication method	A	Manual lubrication or drip lubrication	Details on Pg. 202
	B	Oil bath or slinger disc lubrication	
	C	Forced pump lubrication	

Before Use | Standard Roller Chains | Lubrication-Free Roller Chains | Heavy Duty Roller Chains | Corrosion Resistant Roller Chains | Specialty Roller Chains | Sprockets | Pin Gear Drives | Accessories | Selection | Handling

RS200 Sprocket

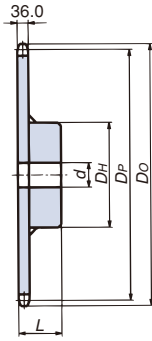

Welded construction
1B type

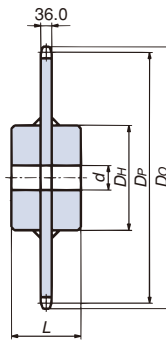

Welded construction
1C type



1A type

Number of Teeth	Pitch Circular Diameter (D _p)	Sprocket Outer Diameter (D _o)	1B type					1C type					1A type			Number of Teeth		
			Bore Diameter (d)		Hub		Approx. Mass (kg)	Material	Bore Diameter (d)		Hub		Approx. Mass (kg)	Material	Pilot Bore Diameter (d)		Approx. Mass (kg)	Material
			Pilot Bore Diameter	Maximum	Diameter (D _H)	Length (L)			Pilot Bore Diameter	Maximum	Diameter (D _H)	Length (L)						
11	225.39	254	43	80	130	65	12.3								43	9.4		11
12	245.34	275	43	90	150	75	16.6								43	11.3		12
13	265.34	296	43	100	170	80	21.0								43	13.4		13
14	285.37	316	43	110	180	80	24.3								43	15.7		14
15	305.42	337	43	115	180	80	26.8								43	18.2		15
16	325.49	357	43	115	180	80	29.5								43	20.9		16
17	345.58	378	43	120	190	85	34.5								43	23.7		17
18	365.68	398	43	120	190	85	37.5								43	26.8		18
19	385.79	419						63	125	200	90	41.7			63	29.5		19
20	405.92	439						63	125	200	90	45.1			63	32.9		20
21	426.05	459						63	135	220	110	56.5			63	36.1		21
22	446.20	480						63	135	220	110	60.2			63	39.9		22
23	466.34	500						63	140	230	110	66.2			63	43.8		23
24	486.49	520						63	140	230	110	70.3			63	47.8		24
25	506.65	541						63	140	230	110	74.6			63	52.2		25
26	526.81	561						63	140	230	110	79.1			63	56.7		26
27	546.98	581						63	140	230	110	83.7			63	61.3		27
28	567.14	602						63	140	230	110	88.5			63	66.1		28
30	607.49	642						63	150	240	125	105.8			63	76.3		30
32	647.85	683						63	150	240	125	116.7			63	87.2		32
34	688.21	723						63	150	240	125	128.3			63	98.8		34
35	708.39	744						63	150	240	125	134.5			63	104.9		35
36	728.58	764						63	150	240	125	140.7			63	111.2		36
38	768.96	804						63	150	240	125	153.8			63	124.2		38
40	809.34	845						63	170	270	140	182.3			63	138.1		40
42	849.73	885						63	170	270	140	196.8			63	152.6		42
45	910.31	946						63	170	270	140	219.9			63	175.8		45
48	970.90	1007						68	170	270	140	244.1			68	200.4		48
50	1011.30	1047						68	170	270	140	261.5			68	217.8		50
54	1092.10	1128						68	170	270	140	298.5			68	254.7		54
60	1213.31	1250						68	170	270	140	359.4			68	315.6		60

- Note: 1. Maximum bore diameter is the typical range. Determine bore diameter and key bearing pressure based on general mechanical design
 2. Outer diameters in the table above are for 1B models. Diameters may vary for other models.
 3. Made-to-order item
 4. The dimensions shown in this catalog are nominal dimensions and differ from actual dimensions.

Hanging hole dimensions

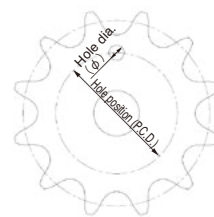

The phase relationship between the hanging hole and teeth may vary.

No. of teeth	1B, 1C, 1A Type bore dia. (φ40) Hole position (P.C.D.)	No. of teeth	1B, 1C, 1A Type bore dia. (φ40) Hole position (P.C.D.)
21	291	34	553
22	311	35	573
23	331	36	593
24	351	38	634
25	371	40	674
26	392	42	715
27	412	45	775
28	432	48	836
30	472	50	876
32	513	54	957
		60	1078

Model numbering

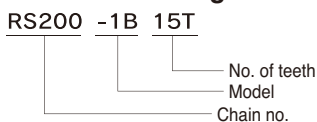

RS240

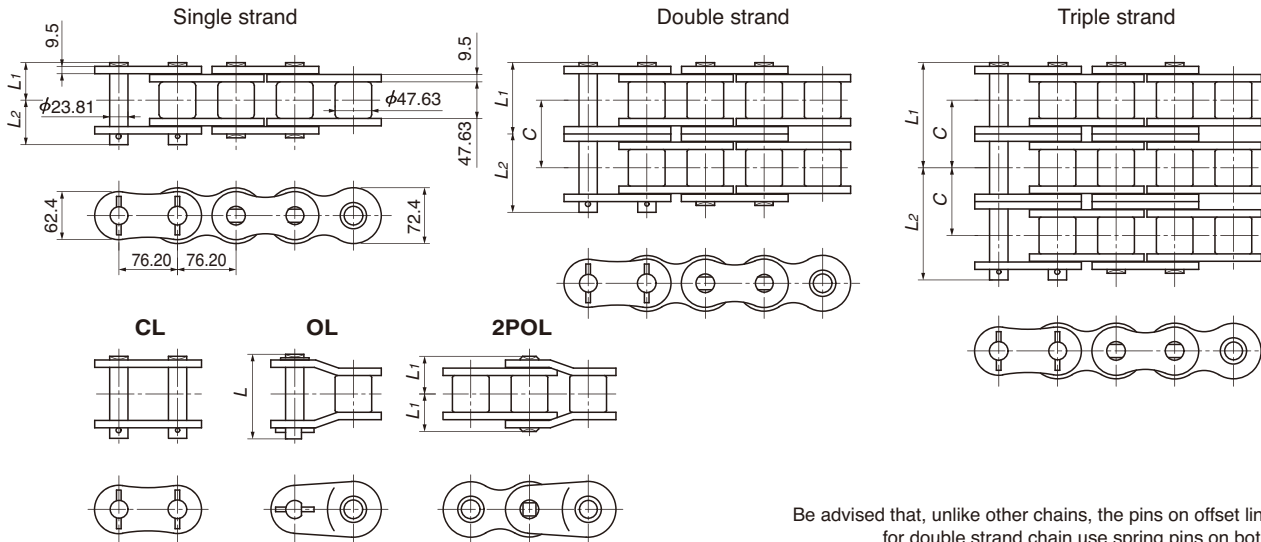

Be advised that, unlike other chains, the pins on offset links (OL) for double strand chain use spring pins on both sides.

TSUBAKI Chain Number	Number of Strands	Pin Length L ₁ +L ₂	Dimensions L ₁	Dimensions L ₂	Offset Pin Length L	Transverse Pitch C	Pin Type	ANSI Standard Min. Tensile Strength kN{kgf}	Tsubaki Minimum Tensile Strength kN{kgf}	Tsubaki Average Tensile Strength kN{kgf}	Maximum Allowable Load kN{kgf}	Approximate Mass kg/m
RS240-1	1	103.4	47.9	55.5	106.7	87.8	Riveting	500.0{50986}	623 {63500}	686 {70000}	99.0{10100}	24.5
RS240-2	2	191.3	91.9	99.4	198.4			1000.0{101972}	1250{127000}	1370{140000}	168{17170}	48.1
RS240-3	3	279.0	135.85	143.15	286.3			1500.0{152958}	1870{190500}	2060{210000}	248{25250}	71.6
RS240-4	4	367.1	179.8	187.3	374.2			-	2490{254000}	2750{280000}	327{33330}	95.1
RS240-5	5	455.0	223.75	231.25	462.0			-	3110{317500}	3430{350000}	386{39390}	118.6
RS240-6	6	542.8	267.7	275.1	550.1			-	3740{381000}	4120{420000}	456{46460}	142.1

- Note: 1. Maximum allowable load when using a one-pitch offset link (OL) is 65% of the above. Two pitch offset links (2POL) can be used at 100% of the above values.
 2. Number of links per unit = 40
 3. Items in bold are stocked in units, while other items are made-to-order.
 4. The dimensions shown in this catalog are nominal dimensions and differ from actual dimensions.

■ RS240-1 Maximum Kilowatt Ratings Table (kW Ratings for Single Strand Chain)

Small Sprocket No. of Teeth	Small Sprocket Max rpm																			
	5	10	15	20	25	30	40	50	60	80	100	125	150	175	200	250	300	350	400	450
9	5.66	10.7	15.4	20.0	24.4	28.8	37.3	45.6	53.7	69.6	85.1	104	123	141	159	159	159	126	103	86.4
10	6.29	12.0	17.3	22.4	27.4	32.3	41.8	51.1	60.2	78.0	95.4	117	137	158	178	183	183	148	121	101
11	6.92	13.3	19.2	24.8	30.4	35.8	46.3	56.7	66.8	86.5	106	129	152	175	197	202	202	170	139	117
12	7.54	14.6	21.1	27.3	33.4	39.3	50.9	62.2	73.3	95.0	116	142	167	192	217	222	222	194	159	
13	8.17	15.9	23.0	29.7	36.4	42.8	55.5	67.9	80.0	104	127	155	182	210	236	242	242	219	179	
14	8.80	17.3	24.9	32.2	39.4	46.4	60.1	73.5	86.6	112	137	168	198	227	256	263	263	244	200	
15	9.43	18.6	26.8	34.7	42.4	50.0	64.8	79.2	93.3	121	148	181	213	245	276	283	283	271	222	
16	10.1	19.9	28.7	37.2	45.5	53.6	69.5	84.9	100	130	158	194	228	262	296	299	299	269	244	
17	10.7	21.3	30.7	39.7	48.6	57.2	74.2	90.7	107	138	169	207	244	280	300	300	300	281	268	
18	11.3	22.6	32.6	42.3	51.7	60.9	78.9	96.4	114	147	180	220	259	298	303	303	303	291	281	
19	11.9	23.9	34.6	44.8	54.8	64.6	83.6	102	120	156	191	233	275	316	317	317	317	304	291	
20	12.6	25.0	36.6	47.4	57.9	68.2	88.4	108	127	165	202	246	290	330	330	330	330	316	304	
21	13.2	26.4	38.5	49.9	61.0	71.9	93.2	114	134	174	213	260	306	345	345	345	345	328	316	
22	13.8	27.7	40.5	52.5	64.2	75.6	98.0	120	141	183	223	273	322	346	346	346	346	342	339	315
23	14.5	28.4	42.5	55.1	67.3	79.3	103	126	148	192	234	287	338	370	370	370	370	359	350	334
24	15.1	30.2	44.5	57.7	70.5	83.1	108	132	155	201	246	300	354	396	396	396	396	376	360	
25	15.7	31.4	46.5	60.3	73.7	86.8	112	137	162	210	257	314	370	410	410	410	410	388	370	
26	16.3	32.7	48.5	62.9	76.9	90.6	117	143	169	219	268	327	386	418	418	418	418	397	380	

- Note: 1. kW rating when using a one-pitch offset link (OL) is 65% of the above. Two pitch offset links (2POL) can be used at 100% of the above values.
 2. Please contact a Tsubaki representative prior to use of kW ratings in the colored area of the table.

Multi-strand factor	Number of chain strands	Multi-strand factor	Number of chain strands	Multi-strand factor
	Double strand	1.7	Quintuple strand	3.9
	Triple strand	2.5	Sextuple strand	4.6
	Quadruple strand	3.3	-	-

Lubrication method	A	Manual lubrication or drip lubrication	Details on Pg. 202
	B	Oil bath or slinger disc lubrication	
	C	Forced pump lubrication	

Before Use | Standard Roller Chains | Lubrication-Free Roller Chains | Heavy Duty Roller Chains | Corrosion Resistant Roller Chains | Specialty Roller Chains | Sprockets | Pin Gear Drives | Accessories | Selection | Handling

RS240 Sprocket

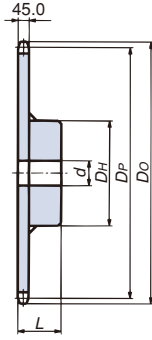

Welded construction
1B type

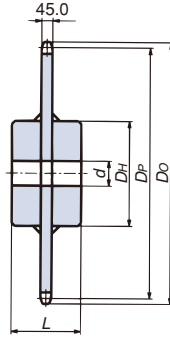

Welded construction
1C type

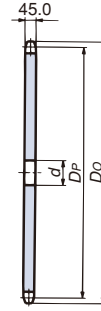

1A type

Number of Teeth	Pitch Circular Diameter (Dp)	Sprocket Outer Diameter (Do)	1B type					1C type					1A type			Number of Teeth						
			Bore Diameter (d)		Hub		Approx. Mass (kg)	Material	Bore Diameter (d)		Hub		Approx. Mass (kg)	Material	Pilot Bore Diameter (d)		Approx. Mass (kg)	Material				
			Pilot Bore Diameter	Maximum	Diameter (D _H)	Length (L)			Pilot Bore Diameter	Maximum	Diameter (D _H)	Length (L)										
11	270.47	305	43	90	150	75	21.3	Welded construction: machine-structural carbon steel (teeth) and structural rolled steel (hub)											11			
12	294.41	330	43	100	170	85	27.8													12		
13	318.41	355	43	120	200	100	37.7													13		
14	342.44	380	43	130	210	110	46.0													14		
15	366.50	404							63	140	230	110	52.4	Welded construction: structural rolled steel (teeth and hub)							15	
16	390.59	429							63	140	230	110	57.2		63	37.3	Machine-structural carbon steel				16	
17	414.70	453							63	145	230	110	62.3		63	42.4						17
18	438.82	478							63	145	230	110	67.8		63	47.9						18
19	462.95	502							63	150	240	120	78.7		63	53.6						19
20	487.11	527							63	150	240	120	84.3		63	59.2						20
21	511.26	551							63	155	240	120	90.7		63	65.6						21
22	535.43	576							63	155	240	120	97.4		63	72.3						22
23	559.61	600							63	160	260	140	116.9		63	79.4						23
24	583.79	625							63	160	260	140	124.3		63	86.8						24
25	607.98	649							63	160	260	140	132.0		63	94.5						25
26	632.17	673							63	160	260	140	140.1		63	102.6						26
27	656.37	698							63	160	260	140	148.5		63	111.0						27
28	680.57	722							63	160	260	140	157.1		63	119.6						28
30	728.99	771							63	165	260	140	175.5		63	138.0						30
32	777.42	819							63	165	260	140	195.1		63	157.6						32
34	825.86	868						63	165	260	140	216.1	63		178.5						34	
35	850.07	892						63	165	260	140	227.0	63		189.4						35	
36	874.30	917						63	165	260	140	238.3	63		200.8						36	
38	922.75	965						63	165	260	140	261.8	63		224.3						38	
40	971.21	1014						68	170	270	140	289.3	68	248.9						40		
42	1019.67	1063						68	170	270	140	315.4	68	275.2					42			
45	1092.37	1135						68	170	270	140	357.0	68	316.8					45			
48	1165.08	1208						68	170	270	140	401.6	68	361.4					48			
50	1213.56	1257						68	170	270	140	432.9	68	392.7					50			
54	1310.52	1354						68	170	270	140	499.5	68	459.2					54			
60	1455.98	1500						68	170	270	140	609.3	68	568.8					60			

Note: 1. Maximum bore diameter is the typical range. Determine bore diameter and key bearing pressure based on general mechanical design
 2. Outer diameters in the table above are for 1B models. Diameters may vary for other models.
 3. Made-to-order item
 4. The dimensions shown in this catalog are nominal dimensions and differ from actual dimensions.

Hanging hole dimensions

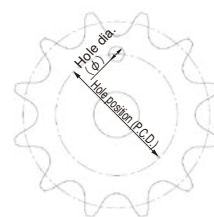

The phase relationship between the hanging hole and teeth may vary.

No. of teeth	1B, 1C, 1A Type bore dia. (φ40) Hole position (P.C.D.)	No. of teeth	1B, 1C, 1A Type bore dia. (φ40) Hole position (P.C.D.)
20	355	32	635
21	378	34	681
22	401	35	704
23	424	36	726
24	447	38	773
25	470	40	821
26	494	42	867
27	517	45	938
28	540	48	1009
30	587	50	1054
		54	1148
		60	1291

Model numbering

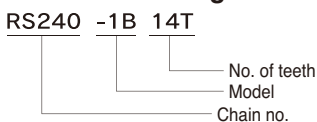

RF320-T, RF400-T

RF320-T

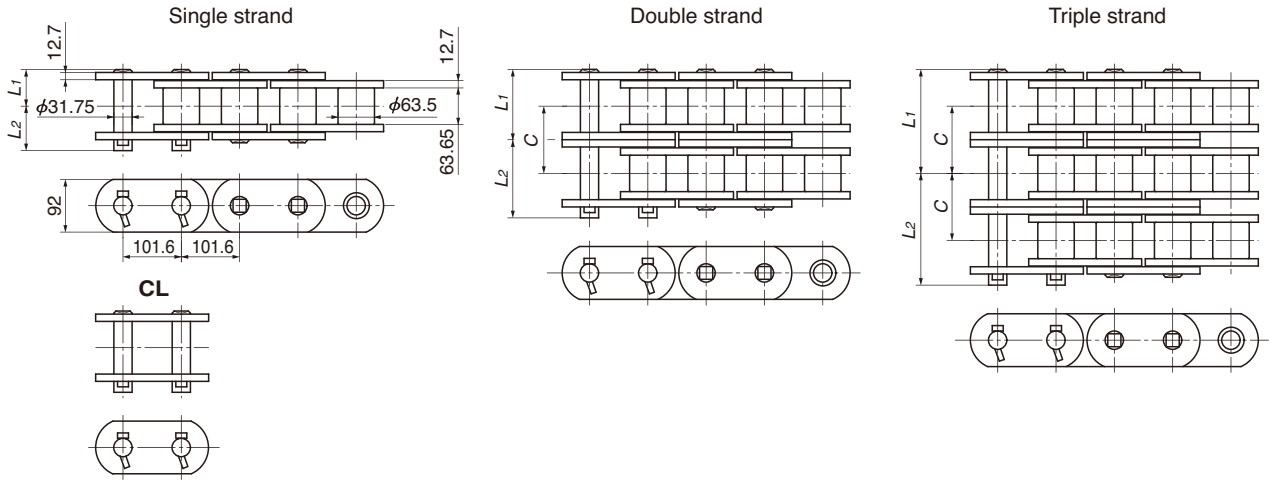

TSUBAKI Chain Number	Number of Strands	Pin Length L_1+L_2	Dimensions L_1	Dimensions L_2	Offset Pin Length L	Transverse Pitch C	Pin Type	Tsubaki Minimum Tensile Strength kN{kgf}	Tsubaki Average Tensile Strength kN{kgf}	Maximum Allowable Load kN{kgf}	Approximate Mass kg/m
RF320-T-1	1	141.4	63.8	77.6	—	117.1	Riveting	1000{102000}	1150{117000}	123{12500}	47.6
RF320-T-2	2	258.7	122.4	136.3	—			2000{204000}	2290{234000}	208{21250}	94.6
RF320-T-3	3	375.9	181.0	194.9	—			3000{306000}	3440{351000}	306{31250}	141.5
RF320-T-4	4	493.2	239.65	253.55	—			4000{408000}	4590{468000}	405{41250}	188.5

- Note 1. Number of links per unit = 30
 2. Made-to-order item
 3. The dimensions shown in this catalog are nominal dimensions and differ from actual dimensions.

RF400-T

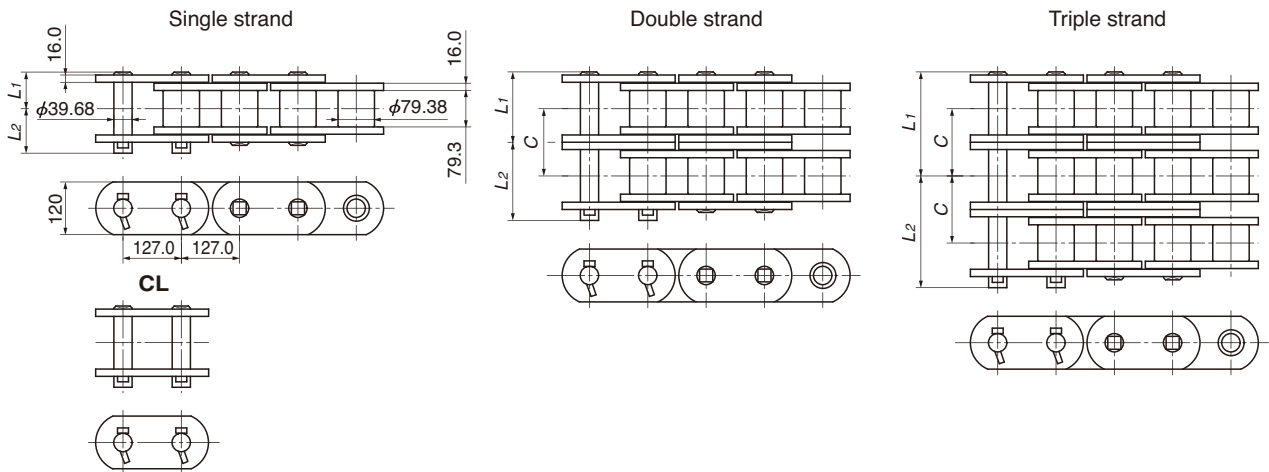

TSUBAKI Chain Number	Number of Strands	Pin Length L_1+L_2	Dimensions L_1	Dimensions L_2	Offset Pin Length L	Transverse Pitch C	Pin Type	Tsubaki Minimum Tensile Strength kN{kgf}	Tsubaki Average Tensile Strength kN{kgf}	Maximum Allowable Load kN{kgf}	Approximate Mass kg/m
RF400-T-1	1	172.3	79.65	92.65	—	146.8	Riveting	1730{176000}	1950{199000}	188{19200}	83.9
RF400-T-2	2	319.0	153.05	165.95	—			3450{352000}	3900{398000}	320{32640}	166.8
RF400-T-3	3	465.7	226.45	239.25	—			5180{528000}	5850{597000}	471{48000}	249.7
RF400-T-4	4	612.3	299.8	312.5	—			6900{704000}	7810{796000}	621{63360}	332.7

- Note 1. Number of links per unit = 24
 2. Made-to-order item
 3. The dimensions shown in this catalog are nominal dimensions and differ from actual dimensions.

Before Use | Standard Roller Chains | Lubrication | Heavy Duty Roller Chains | Corrosion Resistant Roller Chains | Specialty Roller Chains | Sprockets | Pin Gear Drives | Accessories | Selection | Handling

MEMO

Horizontal dashed lines for writing.

BS/DIN Standard RS Roller Chain

Tsubaki presents its 4th generation BS/DIN standard RS Roller Chain, GT4 WINNER.

GT4 WINNER was crafted with ultimate wear life in mind, a proven benefit for customers looking for real savings in chain maintenance & product replacement. Tsubaki BS/DIN European Standard chain is available in chain sizes from RS05B to RS56B. Single, double, and triple strand chains are available.



1 Lube Groove (LG) Solid Bush

Thanks to Tsubaki's own innovative fabrication technology, we have developed a new seamless solid bush. This high precision solid bush with special lube grooves (LG) improves lubrication retention, greatly extending the original wear life of the chain.

※ LG solid bushes (PAT.) are available for 16B to 24B



Lube Groove (LG) Solid Bush

2 Ring Coining (RC)

Residual stress generated from a groove around the connecting plate hole eliminates strength reduction caused by the gap between the pin and the plate necessary for connecting and disconnecting. With this groove, the connecting link achieves the same strength as the chain itself.

※ Ring coining is available for 08B to 40B



Ring Coining (RC)

3 Center Sink Rivet

Tsubaki's chains can easily be disassembled thanks to our unique center sink rivet head, reducing the time needed for chain maintenance.

An additional benefit is that should the chain be inadvertently overloaded, the markings on the rivet head will identify where pin rotation has occurred, giving a clear indication of chain overload.

※ Center sink rivets are available for 08B to 16B



Center Sink Rivet

Extremely Long Wear Life

Wear Elongation Comparison

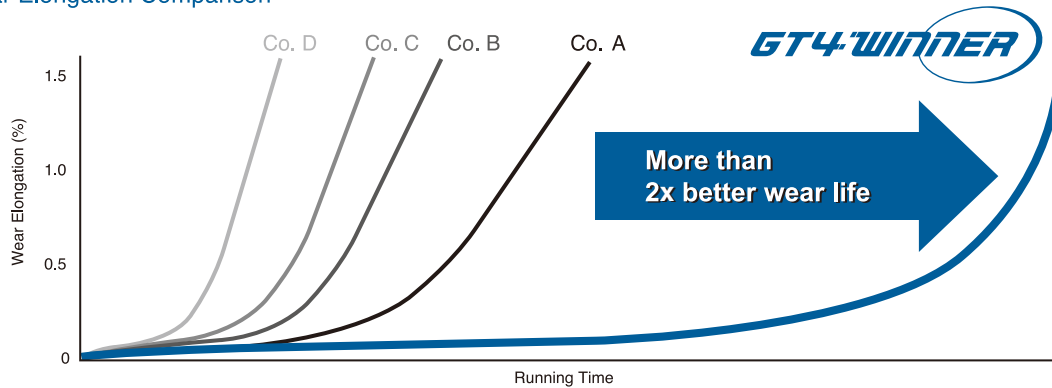

CO2 Reduction

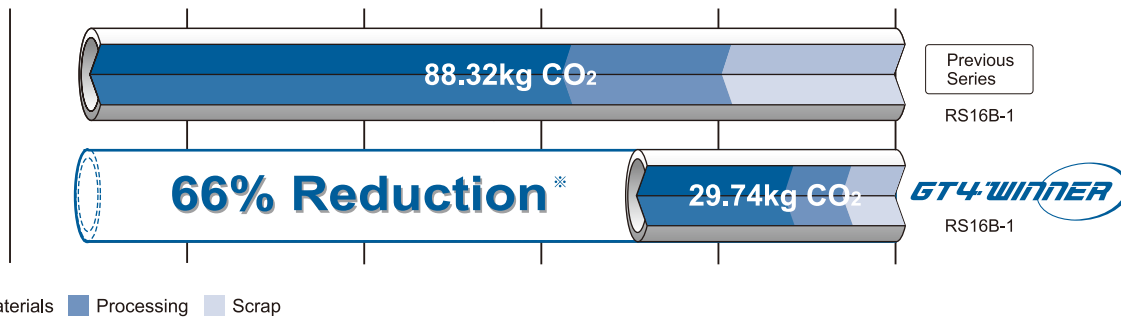

With its focus on manufacturing chain with a substantially longer wear life, Tsubaki is helping to create an environment in harmony with our planet. Less frequent chain replacement results in less consumption of resources and contributes to significantly lower CO2 emissions.

※ Results of RS Roller Chain (16B-1) LCA inventory analysis.

Quick and Accurate Selection

We are listing our new maximum allowable loads, as well as our new maximum kilowatt ratings table. This will allow quicker and more accurate chain selection.

Lubrication Type Small Sprocket No. of Teeth	Small Sprocket Max rpm																					
	10	25	50	100	150	200	300	400	500	600	700	800	900	1000	1100	1200	1400	1600	1800	2000	2200	
	A I				A II				B													
9	0.35	0.81	1.51	2.82	4.06	5.25	7.57	9.81	12.0	14.1	16.2	15.1	12.7	10.8	9.39	8.24	6.54	5.35	4.48	3.83	3.1	
10	0.40	0.91	1.69	3.16	4.54	5.89	8.48	11.0	13.4	15.8	18.2	17.7	14.9	12.7	11.0	9.65	7.66	6.27	5.25	4.48	3.8	
11	0.44	1.00	1.87	3.50	5.04	6.53	9.40	12.2	14.9	17.5	20.2	20.4	17.1	14.6	12.7	11.1	8.83	7.23	6.06	5.17	4.4	
12	0.48	1.10	2.06	3.84	5.53	7.17	10.3	13.4	16.4	19.3	22.1	23.3	19.5	16.7	14.5	12.7	10.1	8.24	6.90	5.89	5.1	
13	0.53	1.20	2.24	4.19	6.03	7.82	11.3	14.6	17.8	21.0	24.1	26.3	22.0	18.8	16.3	14.3	11.3	9.29	7.78	6.65	5.7	
14	0.57	1.30	2.43	4.54	6.54	8.47	12.2	15.8	19.3	22.8	26.1	29.4	24.6	21.0	18.2	16.0	12.7	10.4	8.70	7.43	6.4	
15	0.62	1.40	2.62	4.89	7.04	9.12	13.1	17.0	20.8	24.5	28.2	31.8	27.3	23.3	20.2	17.7	14.1	11.5	9.65	8.24	7.1	
16	0.66	1.51	2.81	5.24	7.55	9.78	14.1	18.3	22.3	26.3	30.2	34.1	30.1	25.7	22.2	19.5	15.5	12.7	10.6	9.08	7.8	
17	0.70	1.61	3.00	5.60	8.06	10.4	15.0	19.5	23.8	28.1	32.2	36.4	32.9	28.1	24.4	21.4	17.0	13.9	11.6	9.94	8.6	
18	0.75	1.71	3.19	5.95	8.57	11.1	16.0	20.7	25.3	29.9	34.3	38.7	35.9	30.6	26.5	23.3	18.5	15.1	12.7	10.8	9.5	
19	0.79	1.81	3.38	6.31	9.09	11.8	17.0	22.0	26.9	31.7	36.4	41.0	38.9	33.2	28.8	25.3	20.1	16.4	13.8	11.7	10.1	
20	0.84	1.92	3.57	6.67	9.61	12.4	17.9	23.2	28.4	33.5	38.4	43.3	42.0	35.9	31.1	27.3	21.7	17.7	14.9	12.7	11.1	
21	0.89	2.02	3.77	7.03	10.1	13.1	18.9	24.5	29.9	35.3	40.5	45.7	45.2	38.6	33.5	29.4	23.3	19.1	16.0	13.6	11.9	
22	0.93	2.12	3.96	7.39	10.6	13.8	19.9	25.7	31.5	37.1	42.6	48.0	48.5	41.4	35.9	31.5	25.0	20.4	17.1	14.6	12.6	
23	0.98	2.22	4.14	7.74	11.2	14.5	20.8	27.0	33.0	38.9	44.7	50.4	51.9	43.9	38.9	34.7	28.9	23.9	20.6	17.6	15.3	

*Table above is for illustration purpose only.

BS/DIN Standard RS Roller Chain

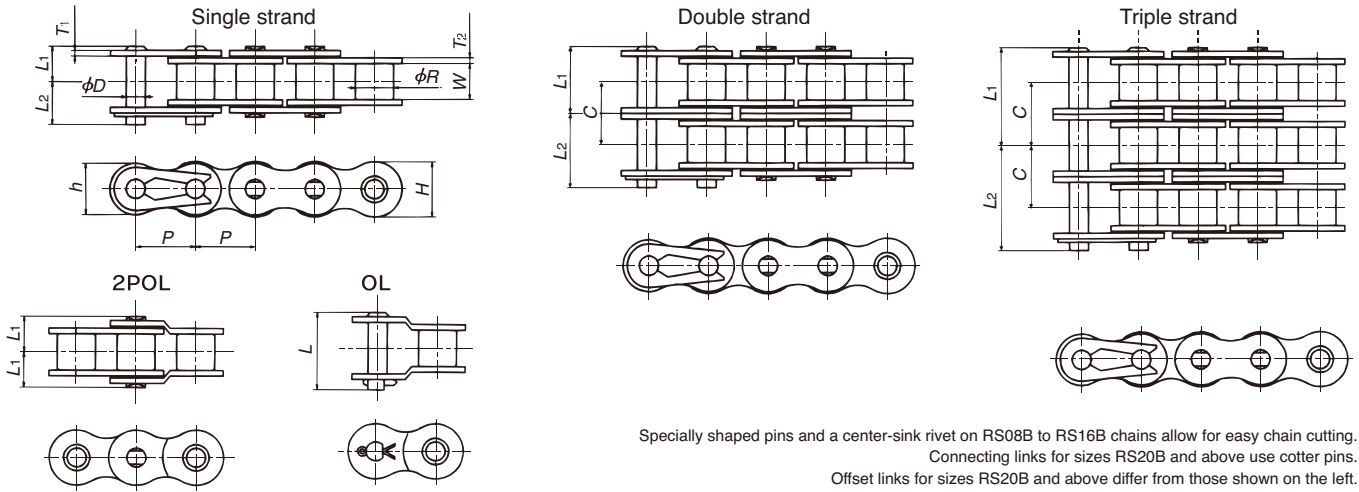

TSUBAKI Chain Number	JIS No.	Pitch P	Roller Diameter R	Inner Width of Inner Link W	Plates				Pin Diameter D
					Thickness T ₁	Thickness T ₂	Height H	Height h	
RS05B-1	05B	8.00	5.00	3.00	0.75	0.75	7.1	7.1	2.30
RF06B-1	06B	9.525	6.35	5.72	1.0	1.3	8.2	8.2	3.27
RS08B-1	08B	12.70	8.51	7.75	1.6	1.6	11.8	10.4	4.45
RS10B-1	10B	15.875	10.16	9.65	1.5	1.5	14.7	13.7	5.08
RS12B-1	12B	19.05	12.07	11.68	1.8	1.8	16.1	16.1	5.72
RS16B-1	16B	25.40	15.88	17.02	3.2	4.0	21.0	21.0	8.28
RS20B-1	20B	31.75	19.05	19.56	3.4	4.4	26.0	26.0	10.19
RS24B-1	24B	38.10	25.40	25.40	5.6	6.0	33.4	31.2	14.63
RS28B-1	28B	44.45	27.94	30.99	6.3	7.5	36.4	36.4	15.90
RS32B-1	32B	50.80	30.99	29.21	6.3	7.0	42.2	41.6	17.81
RS40B-1	40B	63.50	39.37	38.10	8.0	8.5	52.9	52.0	22.89
RS48B-1	48B	76.2	48.26	45.72	10.0	12.1	63.8	59.8	29.23
RS56B-1	56B	88.9	53.98	53.34	12.3	13.6	77.8	73.0	34.32

Note: Outer plate thickness is given for single-strand chain. Outer plate thickness will vary for multi-strand chains due to their relation to the horizontal pitch.

TSUBAKI Chain Number	Number of Strands	Pin Length L ₁ + L ₂	Dimensions L ₁	Dimensions L ₂	Offset Pin Length L	Transverse Pitch C	Tsubaki Minimum Tensile Strength kN{kgf}	ISO "B" Tensile Strength kN{kgf}	Maximum Allowable Load kN{kgf}	Approximate Mass kg/m
RS05B-1	1	8.5	3.8	4.7	—	—	5.0 {510}	4.4 {449}	1.26{128}	0.18
RF06B-1	1	13.8	6.1	7.7	15.1	—	9.0 {920}	8.90 {910}	1.95{199}	0.39
RF06B-2	2	24.0	11.2	12.8	25.9	10.24	17.0 {1730}	16.9 {1720}	3.32{339}	0.75
RF06B-3	3	34.3	16.4	17.9	36.1	—	24.9 {2540}	24.9 {2540}	4.88{498}	1.11
RS08B-1	1	18.4	8.4	10.0	18.6	—	19.0 {1930}	17.8 {1820}	3.80{387}	0.70
RS08B-2	2	32.2	15.3	16.9	34.5	13.92	32.0 {3260}	31.1 {3170}	6.46{659}	1.35
RS08B-3	3	46.1	22.25	23.85	48.4	—	47.5 {4840}	44.5 {4540}	9.50{969}	2.00
RS10B-1	1	20.8	9.55	11.25	20.8	—	23 {2340}	22.2 {2260}	4.52{461}	0.95
RS10B-2	2	37.4	17.85	19.55	39.4	16.59	44.5 {4540}	44.5 {4540}	7.68{783}	1.85
RS10B-3	3	54.0	26.15	27.85	56.0	—	66.8 {6810}	66.7 {6800}	11.3{1150}	2.80
RS12B-1	1	24.1	11.1	13.0	24.4	—	31 {3160}	28.9 {2950}	5.28{538}	1.25
RS12B-2	2	43.6	20.85	22.75	45.9	19.46	61 {6220}	57.8 {5890}	8.98{916}	2.50
RS12B-3	3	63.1	30.6	32.5	65.4	—	92 {9400}	86.7 {8840}	13.2{1350}	3.80
RS16B-1	1	37.7	17.75	19.95	41.1	—	70 {7100}	60 {6120}	13.1{1340}	2.70
RS16B-2	2	69.3	33.55	35.75	75.2	31.88	128 {13000}	106 {10800}	22.3{2270}	5.40
RS16B-3	3	101.2	49.5	51.7	107.1	—	192 {19600}	160 {16300}	32.8{3340}	8.00
RS20B-1	1	43.0	19.9	23.1	46.6	—	98.1{10000}	95 {9690}	18.4{1880}	3.85
RS20B-2	2	79.7	38.25	41.45	84.6	36.45	197 {20100}	170 {17300}	31.3{3190}	7.65
RS20B-3	3	116.2	56.5	59.7	121.0	—	295 {30100}	250 {25500}	46.0{4690}	11.45
RS24B-1	1	58.5	26.65	31.85	61.7	—	167 {17000}	160 {16300}	27.1{2760}	7.45
RS24B-2	2	106.8	50.8	56.0	112.8	48.36	335 {34100}	280 {28600}	46.1{4700}	14.65
RS24B-3	3	155.3	75.1	80.2	161.1	—	500 {51000}	425 {43300}	67.8{6910}	21.75
RS28B-1	1	69.9	32.45	37.45	74.4	—	200 {20400}	200 {20400}	37.5{3820}	9.45
RS28B-2	2	129.3	62.15	67.15	136.6	59.56	374 {38100}	360 {36700}	63.8{6510}	18.80
RS28B-3	3	188.9	91.95	96.95	195.9	—	560 {57100}	530 {54000}	93.8{9570}	28.20
RS32B-1	1	69.8	32.1	37.7	73.3	—	255 {26000}	250 {25500}	41.0{4180}	10.25
RS32B-2	2	128.1	61.25	66.85	134.5	58.55	485 {49500}	450 {45900}	69.7{7110}	20.10
RS32B-3	3	186.6	90.5	96.1	192.6	—	729 {74300}	670 {68300}	103 {10500}	29.90
RS40B-1	1	84.3	39.25	45.05	88.6	—	373 {38000}	355 {36200}	51.0{5200}	16.35
RS40B-2	2	156.6	75.4	81.2	163.2	72.29	716 {73000}	630 {64200}	86.7{8840}	32.00
RS40B-3	3	228.8	111.5	117.3	235.3	—	1080 {110000}	950 {96900}	128 {13100}	47.75
RS48B-1	1	108.1	49.3	58.8	117.7	—	565 {57600}	560 {57600}	77.0{7850}	25.00
RS48B-2	2	199.4	95.0	104.4	209.0	91.21	1000 {102000}	1000 {102000}	131 {13400}	50.00
RS48B-3	3	290.6	140.6	150.0	300.2	—	1520 {155000}	1500 {153000}	193 {19700}	75.00
RS56B-1	1	126.3	57.3	69.0	—	—	851 {86800}	850 {86700}	103 {10500}	33.90
RS56B-2	2	232.9	110.6	122.3	—	106.6	1700 {173000}	1600 {163000}	175 {17800}	67.18
RS56B-3	3	339.5	163.9	175.6	—	—	2250 {229000}	2240 {228000}	257 {26200}	100.40

- Note: 1. RF06B plates are flat .
 2. Multi-strand RF06B and RS08B chains have one middle plate.
 3. Items in bold are stocked in units. All other items are made-to-order. RS48B and 56B are made-to-order.
 4. Maximum allowable load when using 06B, 48B, and 56B with connecting links is 80% of the above.
 5. Maximum allowable load when using one-pitch and two-pitch offset links (OL & 2POL) is 60% of the above.
 6. There is no offset link for 56B.
 7. See pg. 108 for BS/DIN RS roller chain sprockets.
 8. The dimensions shown in this catalog are nominal dimensions and differ from actual dimensions.

Before Use | Standard Roller Chains | Lubrication | Heavy Duty Roller Chains | Corrosion Resistant Roller Chains | Specialty Roller Chains | Sprockets | Pin Gear Drives | Accessories | Selection | Handling

Kilowatt Ratings Tables (RS05B~RS08B)

■RS05B Maximum Kilowatt Ratings Table (kW Ratings for Single Strand Chain)

Lubrication Type Small Sprocket No. of Teeth	Small Sprocket Max rpm																								
	A I					A II					B										C				
	50	100	300	500	700	900	1200	1500	1800	2100	2500	3000	3500	4000	4500	5000	5500	6000	6500	7000	7500	8000	8500	9000	10000
9	0.04	0.07	0.18	0.29	0.39	0.49	0.64	0.78	0.92	1.06	1.09	0.83	0.66	0.54	0.45	0.38	0.33	0.29	0.26	0.23	0.21	0.19	0.17	0.16	0.14
10	0.04	0.08	0.21	0.33	0.44	0.55	0.72	0.87	1.03	1.18	1.27	0.97	0.77	0.63	0.53	0.45	0.39	0.34	0.30	0.27	0.25	0.22	0.20	0.19	0.16
11	0.05	0.08	0.23	0.36	0.49	0.61	0.79	0.97	1.14	1.31	1.47	1.12	0.89	0.73	0.61	0.52	0.45	0.40	0.35	0.31	0.28	0.26	0.23	0.22	0.18
12	0.05	0.09	0.25	0.40	0.54	0.67	0.87	1.07	1.26	1.44	1.67	1.27	1.01	0.83	0.69	0.59	0.51	0.45	0.40	0.36	0.32	0.29	0.27	0.25	0.21
13	0.05	0.10	0.27	0.43	0.58	0.73	0.95	1.16	1.37	1.57	1.84	1.44	1.14	0.93	0.78	0.67	0.58	0.51	0.45	0.40	0.36	0.33	0.30	0.28	0.24
14	0.06	0.11	0.30	0.47	0.63	0.79	1.03	1.26	1.48	1.70	1.99	1.60	1.27	1.04	0.87	0.75	0.65	0.57	0.50	0.45	0.41	0.37	0.34	0.31	0.26
15	0.06	0.12	0.32	0.50	0.68	0.86	1.11	1.36	1.60	1.84	2.15	1.78	1.41	1.16	0.97	0.83	0.72	0.63	0.56	0.50	0.45	0.41	0.37	0.34	0.29
16	0.07	0.13	0.34	0.54	0.73	0.92	1.19	1.45	1.71	1.97	2.30	1.96	1.56	1.27	1.07	0.91	0.79	0.69	0.61	0.55	0.50	0.45	0.41	0.38	0.32
17	0.07	0.14	0.36	0.58	0.78	0.98	1.27	1.55	1.83	2.10	2.46	2.15	1.70	1.39	1.17	1.00	0.86	0.76	0.67	0.60	0.54	0.49	0.45	0.41	0.35
18	0.08	0.14	0.39	0.61	0.83	1.04	1.35	1.65	1.94	2.23	2.61	2.34	1.86	1.52	1.27	1.09	0.94	0.83	0.73	0.66	0.59	0.54	0.49	0.45	0.38
19	0.08	0.15	0.41	0.65	0.88	1.10	1.43	1.75	2.06	2.37	2.77	2.54	2.01	1.65	1.38	1.18	1.02	0.90	0.80	0.71	0.64	0.58	0.53	0.49	0.42
20	0.09	0.16	0.43	0.69	0.93	1.17	1.51	1.85	2.18	2.50	2.93	2.74	2.17	1.78	1.49	1.27	1.10	0.97	0.86	0.77	0.69	0.63	0.57	0.53	0.45
21	0.09	0.17	0.46	0.73	0.98	1.23	1.59	1.95	2.30	2.64	3.09	2.95	2.34	1.91	1.60	1.37	1.19	1.04	0.92	0.83	0.75	0.68	0.62	0.57	0.48
22	0.10	0.18	0.48	0.76	1.03	1.29	1.68	2.05	2.42	2.78	3.25	3.16	2.51	2.05	1.72	1.47	1.27	1.12	0.99	0.89	0.80	0.73	0.66	0.61	0.52
23	0.10	0.19	0.51	0.80	1.08	1.36	1.76	2.15	2.53	2.91	3.41	3.38	2.68	2.19	1.84	1.57	1.36	1.19	1.06	0.95	0.85	0.78	0.71	0.65	0.56
24	0.11	0.20	0.53	0.84	1.13	1.42	1.84	2.25	2.65	3.05	3.57	3.60	2.86	2.34	1.96	1.67	1.45	1.27	1.13	1.01	0.91	0.83	0.76	0.69	0.59
25	0.11	0.21	0.55	0.88	1.19	1.49	1.93	2.35	2.77	3.19	3.73	3.83	3.04	2.49	2.08	1.78	1.54	1.35	1.20	1.07	0.97	0.88	0.80	0.74	0.63
26	0.12	0.21	0.58	0.91	1.24	1.55	2.01	2.46	2.89	3.32	3.89	4.06	3.22	2.64	2.21	1.89	1.64	1.44	1.27	1.14	1.03	0.93	0.85	0.78	0.67
28	0.12	0.23	0.62	0.99	1.34	1.68	2.18	2.66	3.13	3.60	4.21	4.54	3.60	2.95	2.47	2.11	1.83	1.60	1.42	1.27	1.15	1.04	0.95	0.87	0.75
30	0.13	0.25	0.67	1.07	1.44	1.81	2.34	2.87	3.38	3.88	4.54	5.03	3.99	3.27	2.74	2.34	2.03	1.78	1.58	1.41	1.27	1.16	1.06	0.97	0.83
32	0.14	0.27	0.72	1.14	1.55	1.94	2.51	3.07	3.62	4.16	4.87	5.54	4.40	3.60	3.02	2.58	2.23	1.96	1.74	1.56	1.40	1.27	1.16	1.07	0.91
35	0.16	0.30	0.80	1.26	1.70	2.14	2.77	3.38	3.99	4.58	5.36	6.32	5.03	4.12	3.45	2.95	2.56	2.24	1.99	1.78	1.60	1.46	1.33	1.22	1.04
40	0.18	0.34	0.92	1.45	1.97	2.47	3.20	3.91	4.61	5.29	6.19	7.30	6.15	5.03	4.22	3.60	3.12	2.74	2.43	2.17	1.96	1.78	1.62	1.49	1.27
45	0.21	0.39	1.04	1.65	2.24	2.80	3.63	4.44	5.23	6.00	7.00	8.30	7.34	6.01	5.03	4.30	3.72	3.27	2.90	2.59	2.34	2.12	1.94	1.78	1.52

■RF06B Maximum Kilowatt Ratings Table (kW Ratings for Single Strand Chain)

Lubrication Type Small Sprocket No. of Teeth	Small Sprocket Max rpm																								
	A I					A II					B										C				
	50	100	300	500	700	900	1200	1500	1800	2100	2500	3000	3500	4000	4500	5000	5500	6000	6500	7000	7500	8000	8500	9000	10000
9	0.07	0.13	0.34	0.54	0.72	0.91	1.18	1.44	1.70	1.62	1.25	0.95	0.75	0.62	0.52	0.44	0.38	0.34	0.30	0.27	0.24	0.22	0.20	0.18	0.16
10	0.08	0.14	0.38	0.60	0.81	1.02	1.32	1.61	1.90	1.90	1.46	1.11	0.88	0.72	0.61	0.52	0.45	0.39	0.35	0.31	0.28	0.26	0.23	0.21	0.18
11	0.08	0.16	0.42	0.66	0.90	1.13	1.46	1.79	2.11	2.19	1.69	1.28	1.02	0.83	0.70	0.60	0.52	0.45	0.40	0.36	0.33	0.30	0.27	0.25	0.21
12	0.09	0.17	0.46	0.73	0.99	1.24	1.61	1.96	2.31	2.50	1.92	1.46	1.16	0.95	0.80	0.68	0.59	0.52	0.46	0.41	0.37	0.34	0.31	0.28	0.24
13	0.10	0.19	0.50	0.80	1.08	1.35	1.75	2.14	2.52	2.82	2.17	1.65	1.31	1.07	0.90	0.77	0.67	0.58	0.52	0.46	0.42	0.38	0.35	0.32	0.27
14	0.11	0.20	0.54	0.86	1.17	1.46	1.90	2.32	2.73	3.14	2.43	1.84	1.46	1.20	1.00	0.86	0.74	0.65	0.58	0.52	0.47	0.42	0.39	0.36	0.30
15	0.12	0.22	0.59	0.93	1.26	1.58	2.04	2.50	2.94	3.38	2.69	2.05	1.62	1.33	1.11	0.95	0.82	0.72	0.64	0.57	0.52	0.47	0.43	0.39	0.34
16	0.13	0.23	0.63	1.00	1.35	1.69	2.19	2.68	3.16	3.63	2.96	2.25	1.79	1.46	1.23	1.05	0.91	0.80	0.71	0.63	0.57	0.52	0.47	0.43	0.37
17	0.13	0.25	0.67	1.06	1.44	1.81	2.34	2.86	3.37	3.87	3.25	2.47	1.96	1.60	1.34	1.15	0.99	0.87	0.77	0.69	0.62	0.57	0.52	0.48	0.41
18	0.14	0.27	0.71	1.13	1.53	1.92	2.49	3.04	3.58	4.12	3.54	2.69	2.13	1.75	1.46	1.25	1.08	0.95	0.84	0.75	0.68	0.62	0.56	0.52	0.44
19	0.15	0.28	0.76	1.20	1.62	2.04	2.64	3.22	3.80	4.36	3.83	2.92	2.31	1.89	1.59	1.36	1.18	1.03	0.91	0.82	0.74	0.67	0.61	0.56	0.48
20	0.16	0.30	0.80	1.27	1.72	2.15	2.79	3.41	4.02	4.61	4.14	3.15	2.50	2.05	1.71	1.46	1.27	1.11	0.99	0.88	0.80	0.72	0.66	0.61	0.52
21	0.17	0.31	0.84	1.34	1.81	2.27	2.94	3.59	4.23	4.86	4.46	3.39	2.69	2.20	1.84	1.58	1.37	1.20	1.06	0.95	0.86	0.78	0.71	0.65	0.56
22	0.18	0.33	0.89	1.41	1.90	2.39	3.09	3.78	4.45	5.11	4.78	3.63	2.88	2.36	1.98	1.69	1.46	1.28	1.14	1.02	0.92	0.83	0.76	0.70	0.60
23	0.19	0.35	0.93	1.47	2.00	2.50	3.24	3.96	4.67	5.36	5.11	3.88	3.08	2.52	2.11	1.81	1.56	1.37	1.22	1.09	0.98	0.89	0.81	0.75	0.64
24	0.19	0.36	0.97	1.54	2.09	2.62	3.39	4.15	4.89	5.62	5.44	4.14	3.29	2.69	2.25	1.92	1.67	1.46	1.30	1.16	1.05	0.95	0.87	0.80	0.68
25	0.20	0.38	1.02	1.61	2.18	2.74	3.55	4.34	5.11	5.87	5.79	4.40	3.49	2.86	2.40	2.05	1.77	1.56	1.38	1.24	1.11	1.01	0.92	0.85	0.72
26	0.21	0.40	1.06	1.68	2.28	2.86	3.70	4.52	5.33	6.12	6.14	4.67	3.71	3.03	2.54	2.17	1.88	1.65	1.46	1.31	1.18	1.07	0.98	0.90	0.77
28	0.23	0.43	1.15	1.82	2.47	3.09	4.01	4.90	5.78	6.63	6.86	5.22	4.14	3.39	2.84	2.43	2.10	1.84	1.64	1.46	1.32	1.20	1.09	1.00	0.86
30	0.25	0.46	1.24	1.96	2.66	3.33	4.32	5.28	6.22	7.15	7.61	5.79	4.59	3.76	3.15	2.69	2.33	2.05	1.81	1.62	1.46	1.33	1.21	1.11	0.95
32	0.27	0.49	1.33	2.11	2.85	3.58	4.63	5.66	6.67	7.66	8.38	6.38	5.06	4.14	3.47	2.96	2.57	2.25	2.00	1.79	1.61	1.46	1.34	1.23	1.05
35	0.29	0.55	1.47	2.32	3.14	3.94	5.10	6.24	7.35	8.44	9.59	7.29	5.79	4.74	3.97	3.39	2.94	2.58	2.29	2.05	1.84	1.67	1.53	1.40	1.16
40	0.34	0.63	1.69	2.68	3.63	4.55	5.89	7.20	8.49	9.75	11.4	8.91	7.07	5.79	4.85	4.14	3.59	3.15	2.79	2.50	2.25	2.05	1.87	1.65	1.37
45	0.38	0.72	1.92	3.04	4.12	5.17	6.69	8.18	9.64	11.1	13.0	10.6	8.44	6.91	5.79	4.94	4.28	3.76	3.33	2.98					

■RS08B Maximum Kilowatt Ratings Table (kW Ratings for Single Strand Chain)

Kilowatt Ratings Tables (RS10B~RS16B)

■RS10B Maximum Kilowatt Ratings Table (kW Ratings for Single Strand Chain)

Universal Top Small Sprocket No. of Teeth	Small Sprocket Max rpm																											
	10	25	50	100	200	300	400	500	700	900	1000	1200	1400	1600	1800	2100	2400	2700	3000	3500	4000	4500	5000	5500	6000			
	A I				A II				B																	C		
9	0.08	0.17	0.33	0.61	1.13	1.63	2.11	2.58	3.50	4.39	4.82	5.66	4.49	3.67	3.08	2.44	2.00	1.68	1.43	1.14	0.93	0.78	0.67	0.58	0.51			
10	0.09	0.20	0.36	0.68	1.27	1.83	2.37	2.90	3.92	4.92	5.40	6.37	5.26	4.30	3.61	2.86	2.34	1.96	1.68	1.33	1.09	0.91	0.78	0.68	0.59			
11	0.09	0.22	0.40	0.75	1.41	2.03	2.63	3.21	4.35	5.45	5.99	7.06	6.07	4.96	4.16	3.30	2.70	2.26	1.93	1.53	1.26	1.05	0.90	0.78	0.68			
12	0.10	0.24	0.44	0.83	1.55	2.23	2.88	3.53	4.77	5.99	6.58	7.75	6.91	5.66	4.74	3.76	3.08	2.58	2.20	1.75	1.43	1.20	1.02	0.89	0.78			
13	0.11	0.26	0.48	0.90	1.69	2.43	3.15	3.84	5.20	6.53	7.17	8.45	7.79	6.38	5.34	4.24	3.47	2.91	2.48	1.97	1.61	1.35	1.15	1.00				
14	0.12	0.28	0.52	0.98	1.83	2.63	3.41	4.17	5.64	7.07	7.77	9.16	8.71	7.13	5.97	4.74	3.88	3.25	2.78	2.20	1.80	1.51	1.29	1.12				
15	0.13	0.30	0.56	1.05	1.97	2.83	3.67	4.49	6.07	7.62	8.37	9.87	9.66	7.90	6.62	5.26	4.30	3.61	3.08	2.44	2.00	1.68	1.43	1.24				
16	0.14	0.32	0.61	1.13	2.11	3.04	3.94	4.81	6.51	8.17	8.98	10.6	10.6	8.71	7.30	5.79	4.74	3.97	3.39	2.69	2.20	1.85	1.58	1.37				
17	0.15	0.35	0.65	1.21	2.25	3.24	4.20	5.14	6.95	8.72	9.59	11.3	11.7	9.54	7.99	6.34	5.19	4.35	3.71	2.95	2.41	2.02	1.73	1.50				
18	0.16	0.37	0.69	1.28	2.40	3.45	4.47	5.46	7.40	9.27	10.2	12.0	12.7	10.4	8.71	6.91	5.66	4.74	4.05	3.21	2.63	2.20	1.88					
19	0.17	0.39	0.73	1.36	2.54	3.66	4.74	5.79	7.84	9.83	10.8	12.7	13.8	11.3	9.44	7.49	6.13	5.14	4.39	3.48	2.85	2.39	2.04					
20	0.18	0.41	0.77	1.44	2.68	3.87	5.01	6.12	8.29	10.4	11.4	13.5	14.9	12.2	10.2	8.09	6.62	5.55	4.74	3.76	3.08	2.58	2.20					
21	0.19	0.44	0.81	1.52	2.83	4.08	5.28	6.45	8.74	11.0	12.0	14.2	16.0	13.1	11.0	8.71	7.13	5.97	5.10	4.05	3.31	2.78	2.37					
22	0.20	0.46	0.85	1.59	2.98	4.29	5.55	6.79	9.19	11.5	12.7	14.9	17.1	14.0	11.8	9.34	7.64	6.41	5.47	4.34	3.55	2.98	2.54					
23	0.21	0.48	0.90	1.67	3.12	4.50	5.82	7.12	9.64	12.1	13.3	15.7	18.0	15.0	12.6	9.98	8.17	6.85	5.85	4.64	3.80	3.18						
24	0.22	0.50	0.94	1.75	3.27	4.71	6.10	7.46	10.1	12.7	13.9	16.4	18.8	16.0	13.4	10.6	8.71	7.30	6.23	4.94	4.05	3.39						
25	0.23	0.53	0.98	1.83	3.42	4.92	6.37	7.79	10.5	13.2	14.5	17.1	19.7	17.0	14.3	11.3	9.26	7.76	6.62	5.26	4.30	3.61						
26	0.24	0.55	1.02	1.91	3.56	5.13	6.65	8.13	11.0	13.8	15.2	17.9	20.5	18.0	15.1	12.0	9.82	8.23	7.03	5.58	4.56	3.82						
28	0.26	0.59	1.11	2.07	3.86	5.56	7.20	8.81	11.9	14.9	16.4	19.4	22.2	20.2	16.9	13.4	11.0	9.20	7.85	6.23	5.10			4.27				
30	0.28	0.64	1.19	2.23	4.16	5.99	7.76	9.49	12.8	16.1	17.7	20.9	24.0	22.4	18.7	14.9	12.2	10.2	8.71	6.91	5.66							
32	0.30	0.69	1.28	2.39	4.46	6.42	8.32	10.2	13.8	17.3	19.0	22.4	25.7	24.6	20.6	16.4	13.4	11.2	9.59	7.61	6.23							
35	0.33	0.76	1.41	2.63	4.91	7.08	9.17	11.2	15.2	19.0	20.9	24.6	28.3	28.2	23.6	18.7	15.3	12.9	11.0	8.71	6.92							
40	0.38	0.87	1.63	3.04	5.67	8.17	10.6	12.9	17.5	22.0	24.2	28.5	32.7	34.4	28.8	22.9	18.7	15.7	13.4	10.6								
45	0.43	0.99	1.85	3.45	6.44	9.28	12.0	14.7	19.9	24.9	27.4	32.3	37.1	41.1	34.4	27.3	22.4	18.7	16.0									

■RS12B Maximum Kilowatt Ratings Table (kW Ratings for Single Strand Chain)

Universal Top Small Sprocket No. of Teeth	Small Sprocket Max rpm																											
	10	25	50	100	150	200	300	400	500	600	700	800	900	1000	1100	1200	1400	1600	1800	2000	2500	3000	3500	4000	4500			
	A I				A II				B																	C		
9	0.11	0.24	0.46	0.85	1.23	1.59	2.29	2.96	3.62	4.27	4.90	5.53	6.15	6.76	7.37	6.54	5.19	4.25	3.56	3.04	2.18	1.66	1.31	1.08	0.90			
10	0.12	0.27	0.51	0.95	1.37	1.78	2.56	3.32	4.06	4.78	5.50	6.20	6.89	7.58	8.25	7.66	6.08	4.98	4.17	3.56	2.55	1.94	1.54	1.26	1.06			
11	0.13	0.30	0.57	1.06	1.52	1.97	2.84	3.68	4.50	5.30	6.09	6.87	7.64	8.40	9.15	8.84	7.02	5.74	4.81	4.11	2.94	2.24	1.78	1.45	1.22			
12	0.15	0.33	0.62	1.16	1.67	2.17	3.12	4.04	4.94	5.82	6.69	7.55	8.39	9.22	10.1	10.1	8.00	6.54	5.48	4.68	3.35	2.55	2.02	1.66	1.39			
13	0.16	0.36	0.68	1.27	1.82	2.36	3.40	4.41	5.39	6.35	7.30	8.23	9.15	10.1	11.0	11.4	9.02	7.38	6.18	5.28	3.78	2.87	2.28	1.87				
14	0.17	0.39	0.74	1.37	1.98	2.56	3.69	4.78	5.84	6.88	7.90	8.91	9.91	10.9	11.9	12.7	10.1	8.25	6.91	5.90	4.22	3.21	2.55	2.09				
15	0.19	0.42	0.79	1.48	2.13	2.76	3.97	5.15	6.29	7.41	8.52	9.60	10.7	11.8	12.8	13.8	11.2	9.15	7.66	6.54	4.68	3.56	2.83	2.31				
16	0.20	0.46	0.85	1.58	2.28	2.96	4.26	5.52	6.74	7.95	9.13	10.3	11.4	12.6	13.7	14.8	12.3	10.1	8.44	7.21	5.16	3.92	3.11	2.55				
17	0.21	0.49	0.91	1.69	2.44	3.16	4.55	5.89	7.20	8.49	9.75	11.0	12.2	13.4	14.6	15.8	13.5	11.0	9.25	7.90	5.65	4.30	3.41	2.79				
18	0.23	0.52	0.96	1.80	2.59	3.36	4.84	6.27	7.66	9.03	10.4	11.7	13.0	14.3	15.6	16.8	14.7	12.0	10.1	8.60	6.16	4.68	3.72	3.04				
19	0.24	0.55	1.02	1.91	2.75	3.56	5.13	6.64	8.12	9.57	11.0	12.4	13.8	15.2	16.5	17.9	15.9	13.0	10.9	9.33	6.68	5.08	4.03	3.30				
20	0.25	0.58	1.08	2.02	2.90	3.76	5.42	7.02	8.58	10.1	11.6	13.1	14.6	16.0	17.5	18.9	17.2	14.1	11.8	10.1	7.21	5.48	4.35					
21	0.27	0.61	1.14	2.13	3.06	3.97	5.71	7.40	9.05	10.7	12.2	13.8	15.4	16.9	18.4	19.9	18.5	15.2	12.7	10.8	7.76	5.90	4.68					
22	0.28	0.64	1.20	2.23	3.22	4.17	6.01	7.78	9.51	11.2	12.9	14.5	16.1	17.8	19.3	20.9	19.8	16.2	13.6	11.6	8.32	6.33	5.02					
23	0.30	0.67	1.26	2.34	3.38	4.38	6.30	8.17	10.0	11.8	13.5	15.2	16.9	18.6	20.3	21.9	21.2	17.4	14.6	12.4	8.89	6.76	5.37					
24	0.31	0.71	1.32	2.46	3.54	4.58	6.60	8.55	10.5	12.3	14.1	16.0	17.7	19.5	21.2	23.0	22.6	18.5	15.5	13.2	9.48	7.21	5.72					
25	0.32	0.74	1.37	2.57	3.70	4.79	6.90	9.33	10.9	12.9	14.8	16.7	18.5	20.4	22.2	24.0	24.0	19.7	16.5	14.1	10.1	7.66	6.08					
26	0.34	0.77	1.43	2.68	3.86	5.00	7.19	9.82	11.4	13.4	15.4	17.4	19.3	21.3	23.2	25.1	25.5	20.9	17.5	14.9	10.7	8.13	6.45					
28	0.37	0.83	1.55	2.90	4.18	5.41	7.79	10.1	12.3	14.5	16.7	18.8	21.0	23.0	25.1	27.1	28.5	23.3	19.5	16.7	11.9	9.09						
30	0.39	0.90	1.67	3.12	4.50	5.83	8.40	10.9	13.3	15.7	18.0	20.3	22.6	24.8	27.0	29.2	31.6	25.9	21.7	18.5	13.2	10.1						
32	0.42	0.96	1.80	3.35	4.82	6.25	9.00	11.7	14.3	16.8	19.3	21.8	24.2	26.6	29.0	31.4	34.8	28.5	23.9	20.4	14.6	11.1						
35	0.46	1.06	1.98	3.69	5.32	6.89	9.92	12.8	15.7	18.5	21.3	24.0	26.7	29.3	31.9	34.5	39.7	32.6	27.3	23.3	16.7	12.7						
40	0.54	1.22	2.28	4.26	6.14	7.95	11.5	14.8	18.1	21.4	24.6	27.7	30.8	33.9	36.9	39.9	45.8	39.8	33.4	28.5	20.4							
45	0.61	1.39	2.59	4.84	6.97	9.03	13.0	16.9	20.6	24.3	27.9	31.5	35.0	38.5	41.9	45.3	52.1	47.5	39.8	34.0	24.3							

■RS16B Maximum Kilowatt Ratings Table (kW Ratings for Single Strand Chain)

Universal Top Small Sprocket No. of Teeth	Small Sprocket Max rpm																											
	10	25	50	100	150	200	300	400	500	600	700	800	900	1000	1100	1200	1400	1600	1800	2000	2200	2400	2700	3000	3400			
	A I				A II				B																	C		
9	0.35	0.81	1.51	2.82	4.06	5.25	7.57	9.81	12.0	14.1	16.2	15.1	12.7	10.8	9.39	8.24												

Kilowatt Ratings Tables (RS20B~RS28B)

■RS20B Maximum Kilowatt Ratings Table (kW Ratings for Single Strand Chain)

Lubrication Type Small Sprocket No. of Teeth	Small Sprocket Max rpm																							
	10	25	50	100	150	200	300	400	500	600	700	800	900	1000	1100	1200	1300	1400	1600	1800	2000	2200	2400	2600
	A I			A II			B						C											
9	0.62	1.42	2.65	4.94	7.12	9.23	13.3	17.2	21.0	24.8	22.1	18.1	15.2	12.9	11.2	9.85	8.73	7.82	6.40	5.36	4.58	3.97	3.48	3.09
10	0.70	1.59	2.97	5.54	7.98	10.3	14.9	19.3	23.6	27.8	25.9	21.2	17.8	15.2	13.1	11.5	10.2	9.15	7.49	6.28	5.36	4.65	4.08	3.62
11	0.77	1.76	3.29	6.14	8.84	11.5	16.5	21.4	26.1	30.8	29.9	24.4	20.5	17.5	15.2	13.3	11.8	10.6	8.64	7.24	6.18	5.36	4.70	4.17
12	0.85	1.94	3.61	6.75	9.72	12.6	18.1	23.5	28.7	33.8	34.0	27.9	23.3	19.9	17.3	15.2	13.4	12.0	9.85	8.25	7.05	6.11	5.36	1.76
13	0.93	2.11	3.94	7.35	10.6	13.7	19.8	25.6	31.3	36.9	38.4	31.4	26.3	22.5	19.5	17.1	15.2	13.6	11.1	9.31	7.95	6.89	6.04	
14	1.00	2.29	4.27	7.97	11.5	14.9	21.4	27.7	33.9	40.0	42.9	35.1	29.4	25.1	21.8	19.1	16.9	15.2	12.4	10.4	8.88	7.70	6.76	
15	1.08	2.46	4.60	8.58	12.4	16.0	23.1	29.9	36.5	43.1	47.6	38.9	32.6	27.9	24.1	21.2	18.8	16.8	13.8	11.5	9.85	8.54	7.49	
16	1.16	2.64	4.93	9.20	13.3	17.2	24.7	32.0	39.2	46.2	52.4	42.9	35.9	30.7	26.6	23.3	20.7	18.5	15.2	12.7	10.8	9.40	8.25	
17	1.24	2.82	5.27	9.83	14.2	18.3	26.4	34.2	41.8	49.3	56.6	47.0	39.4	33.6	29.1	25.6	22.7	20.3	16.6	13.9	11.9	10.3	9.04	
18	1.32	3.00	5.60	10.5	15.1	19.5	28.1	36.4	44.5	52.4	60.2	51.2	42.9	36.6	31.7	27.9	24.7	22.1	18.1	15.2	12.9	11.2	1.81	
19	1.39	3.18	5.94	11.1	16.0	20.7	29.8	38.6	47.2	55.6	63.8	55.5	46.5	39.7	34.4	30.2	26.8	24.0	19.6	16.4	14.0	12.2		
20	1.47	3.36	6.28	11.7	16.9	21.9	31.5	40.8	49.8	58.7	67.5	59.9	50.2	42.9	37.2	32.6	28.9	25.9	21.2	17.8	15.2	13.1		
21	1.55	3.54	6.62	12.3	17.8	23.0	33.2	43.0	52.5	61.9	71.1	64.5	54.0	46.1	40.0	35.1	31.1	27.9	22.8	19.1	16.3	14.1		
22	1.63	3.73	6.96	13.0	18.7	24.2	34.9	45.2	55.3	65.1	74.8	69.1	57.9	49.5	42.9	37.6	33.4	29.9	24.4	20.5	17.5	15.2		
23	1.71	3.91	7.30	13.6	19.6	25.4	36.6	47.4	58.0	68.3	78.5	73.9	61.9	52.9	45.8	40.2	35.7	31.9	26.1	21.9	18.7	15.5		
24	1.80	4.09	7.64	14.3	20.5	26.6	38.3	49.7	60.7	71.5	82.2	78.8	66.0	56.4	48.9	42.9	38.0	34.0	27.9	23.3	19.9	6.46		
25	1.88	4.28	7.99	14.9	21.5	27.8	40.1	51.9	63.4	74.7	85.9	83.8	70.2	59.9	51.9	45.6	40.9	36.2	29.6	24.8	21.2			
26	1.96	4.46	8.33	15.5	22.4	29.0	41.8	54.1	66.2	78.0	89.6	88.8	74.4	63.6	55.1	48.4	42.9	38.4	31.4	26.3	22.5			
28	2.12	4.84	9.03	16.8	24.3	31.4	45.3	58.6	71.7	84.5	97.0	99.3	83.2	71.0	61.6	54.0	47.9	42.9	35.1	29.4	25.1			
30	2.28	5.21	9.72	18.1	26.1	33.9	48.8	63.2	77.2	91.0	105	110	92.3	78.8	68.3	59.9	53.2	47.6	38.9	32.6	19.0			
32	2.45	5.59	10.4	19.5	28.0	36.3	52.3	67.7	82.8	97.6	112	121	102	86.8	75.2	66.0	58.6	52.4	42.9	35.9				
35	2.70	6.15	11.5	21.4	30.9	40.0	57.6	74.6	91.2	107	123	139	116	99.3	86.1	75.5	67.0	59.9	49.1	41.1				
40	3.12	7.11	13.3	24.8	35.7	46.2	66.5	86.2	105	124	143	161	142	121	105	92.3	81.8	73.2	59.9					
45	3.54	8.07	15.1	28.1	40.5	52.5	75.6	97.9	120	141	162	183	170	145	125	110	97.6	87.4	42.7					

■RS24B Maximum Kilowatt Ratings Table (kW Ratings for Single Strand Chain)

Lubrication Type Small Sprocket No. of Teeth	Small Sprocket Max rpm																								
	10	25	50	100	150	200	300	400	500	600	700	800	900	1000	1100	1200	1300	1400	1500	1600	1700	1800	1900	2000	2100
	A I			A II			B						C												
9	1.10	2.51	4.68	8.74	12.6	16.3	23.5	30.4	37.2	32.2	25.6	20.9	17.5	15.0	13.0	11.4	10.1	9.04	8.15	7.40	6.76	6.20	5.72	5.30	3.57
10	1.23	2.81	5.25	9.79	14.1	18.3	26.3	34.1	41.7	37.7	30.0	24.5	20.5	17.5	15.2	13.3	11.8	10.6	9.55	8.67	7.91	7.26	6.70	6.20	
11	1.37	3.12	5.82	10.9	15.6	20.3	29.2	37.8	46.2	43.5	34.6	28.3	23.7	20.2	17.5	15.4	13.7	12.2	11.0	10.0	9.13	8.38	7.73	7.16	
12	1.50	3.42	6.39	11.9	17.2	22.2	32.0	41.5	50.7	49.6	39.4	32.2	27.0	23.1	20.0	17.5	15.6	13.9	12.6	11.4	10.4	9.55	8.81	8.15	
13	1.64	3.73	6.97	13.0	18.7	24.3	34.9	45.3	55.3	55.9	44.4	36.3	30.5	26.0	22.5	19.8	17.5	15.7	14.2	12.8	11.7	10.8	9.93	4.00	
14	1.77	4.04	7.55	14.1	20.3	26.3	37.8	49.0	59.9	62.5	49.6	40.6	34.0	29.1	25.2	22.1	19.6	17.5	15.8	14.4	13.1	12.0	11.1		
15	1.91	4.36	8.13	15.2	21.9	28.3	40.8	52.8	64.6	69.3	55.0	45.0	37.7	32.2	27.9	24.5	21.7	19.5	17.5	15.9	14.5	13.3	12.3		
16	2.05	4.67	8.72	16.3	23.4	30.4	43.7	56.6	69.2	76.4	60.6	49.6	41.6	35.5	30.8	27.0	24.0	21.4	19.3	17.5	16.0	14.7	11.3		
17	2.19	4.99	9.31	17.4	25.0	32.4	46.7	60.5	73.9	83.7	66.4	54.3	45.5	38.9	33.7	29.6	26.2	23.5	21.2	19.2	17.5	16.1	5.18		
18	2.33	5.30	9.90	18.5	26.6	34.5	49.6	64.3	78.6	91.2	72.3	59.2	49.6	42.4	36.7	32.2	28.6	25.6	23.1	20.9	19.1	17.5			
19	2.47	5.62	10.5	19.6	28.2	36.5	52.6	68.2	83.4	98.2	78.4	64.2	53.8	45.9	39.8	35.0	31.0	27.7	25.0	22.7	20.7	19.0			
20	2.61	5.94	11.1	20.7	29.8	38.6	55.6	72.1	88.1	104	84.7	69.3	58.1	49.6	43.0	37.7	33.5	30.0	27.0	24.5	22.4	15.3			
21	2.75	6.27	11.7	21.8	31.4	40.7	58.6	76.0	92.9	109	91.2	74.6	62.5	53.4	46.3	40.6	36.0	32.2	29.1	26.4	24.1	8.05			
22	2.89	6.59	12.3	22.9	33.0	42.8	61.7	79.9	97.7	115	97.7	80.0	67.0	57.2	49.6	43.5	38.6	34.6	31.2	28.3	25.8	0.02			
23	3.03	6.91	12.9	24.1	34.3	44.9	64.7	83.8	102	121	104	85.5	71.7	61.2	53.0	46.6	41.3	36.9	33.3	30.2	27.6				
24	3.17	7.24	13.5	25.2	36.7	47.0	67.7	87.8	107	126	111	91.2	76.4	65.2	56.5	49.6	44.0	39.9	34.9	35.5	32.2	21.6			
25	3.32	7.56	14.1	26.3	37.9	49.1	70.8	91.7	112	132	118	96.9	81.2	69.3	60.1	52.8	46.8	41.9	37.7	34.3	13.5				
26	3.46	7.89	14.7	27.5	39.6	51.3	73.9	95.7	117	138	126	103	86.1	73.5	63.7	55.9	49.6	44.4	40.0	36.3	4.6				
28	3.75	8.55	16.0	29.8	42.9	55.5	80.0	104	127	149	140	115	96.3	82.2	71.2	62.5	55.5	49.6	44.7	31.0					
30	4.04	9.21	17.2	32.1	46.2	59.8	86.2	112	137	161	156	127	107	91.2	79.0	69.3	61.5	55.0	49.6	12.8					
32	4.33	9.87	18.4	34.4	49.5	64.2	92.4	120	146	172	171	140	118	100	87.0	76.4	67.8	60.6	44.1						
35	4.77	10.9	20.3	37.9	54.6	70.7	102	132	161	190	196	161	135	115	99.6	87.4	77.5	69.3	14.8						
40	5.51	12.6	23.4	43.8	63.0	81.6	118	152	186	219	240	196	164	140	122	107	83.7	20.8							
45	6.26	14.3	26.6	49.7	71.6	92.7	134	173	212	249	286	234	196	167	145	102	32.0								

■RS28B Maximum Kilowatt Ratings Table (kW Ratings for Single Strand Chain)

Lubrication Type Small Sprocket No. of Teeth	Small Sprocket Max rpm																								
	10	25	50	100	150	200	250	300	350	400	450	500	550	600	700	800	900	1000	1100	1200	1300	1400	1500	1600	1700
	A I			A II			B						C												
9	1.78	4.05	7.56	14.1	20.3	26.3	32.2	37.9	43.6	49.1	54.6	47.9	41.5	36.5	28.9	23.7	19.8	16.9	14.7	12.9	11.4	10.2	9.22	8.37	2.37
10	1.99	4.54	8.47	15.8	22.8	29.5	36.1	42.5	48.8	55.0	61.2	56.1	48.7	42.7	33.9	27.7	23.2	19.8	17.2	15.1	13.4	12.0	10.8	9.81	
11	2.21	5.03	9.39	17.5	25.2	32.7	40.0	47.1	54.1	61.0	67.8	64.8	56.1	49.3	39.1										

Kilowatt Ratings Tables (RS32B~RS48B)

■RS32B Maximum Kilowatt Ratings Table (kW Ratings for Single Strand Chain)

Lubrication Type Small Sprocket No. of Teeth	Small Sprocket Max rpm																							
	10	25	50	100	150	200	250	300	350	400	450	500	550	600	650	700	750	800	850	900	1000	1100	1200	1300
	A I			A II			B						C											
9	2.22	5.06	9.45	17.6	25.4	32.9	40.2	47.4	54.4	61.4	62.5	53.3	46.2	40.6	36.0	32.2	29.0	26.4	24.1	22.1	18.9	16.3	14.3	12.7
10	2.49	5.67	10.6	19.7	28.4	36.9	45.1	53.1	61.0	68.8	73.2	62.5	54.1	47.5	42.1	37.7	34.0	30.9	28.2	25.9	22.1	19.1	16.8	14.9
11	2.76	6.29	11.7	21.9	31.5	40.8	49.9	58.8	67.6	76.2	84.4	72.1	62.5	54.8	48.6	43.5	39.2	35.6	32.5	29.8	25.5	22.1	19.4	17.2
12	3.03	6.91	12.9	24.0	34.6	44.9	54.9	64.6	74.3	83.7	93.1	82.1	71.2	62.5	55.4	49.6	44.7	40.6	37.0	34.0	29.0	25.2	22.1	16.8
13	3.30	7.53	14.1	26.2	37.8	48.9	59.8	70.5	81.0	91.3	102	92.6	80.2	70.4	62.5	55.9	50.4	45.7	41.8	38.3	32.7	28.4	24.9	13.8
14	3.58	8.16	15.2	28.4	40.9	53.0	64.8	76.3	87.7	98.9	110	103	89.7	78.7	69.8	62.5	56.3	51.1	46.7	42.8	36.6	31.7	27.8	10.1
15	3.85	8.79	16.4	30.6	44.1	57.1	69.8	82.3	94.5	107	118	115	100	87.3	77.4	69.3	62.5	56.7	51.8	47.5	40.6	35.2	30.9	5.67
16	4.13	9.42	17.6	32.8	47.3	61.2	74.8	88.2	101	114	127	126	110	96.2	85.3	76.3	68.8	62.5	57.0	52.3	44.7	38.7	34.0	0.57
17	4.41	10.1	18.8	35.0	50.5	65.4	79.9	94.2	108	122	136	138	120	105	93.4	83.6	75.4	68.4	62.5	57.3	48.9	42.4	32.1	
18	4.69	10.7	20.0	37.3	53.7	69.5	85.0	100	115	130	144	151	131	115	102	91.1	82.1	74.5	68.1	62.5	53.3	46.2	28.3	
19	4.97	11.3	21.2	39.5	56.9	73.7	90.1	106	122	138	153	164	142	124	110	98.8	89.0	80.8	73.8	67.7	57.8	50.1	23.8	
20	5.26	12.0	22.4	41.8	60.1	77.9	95.2	112	129	145	162	177	153	134	119	107	96.2	87.3	79.7	73.2	62.5	54.1	18.8	
21	5.54	12.6	23.6	44.0	63.4	82.1	100	118	136	153	170	187	165	145	128	115	103	93.9	85.8	78.7	67.2	57.4	13.1	
22	5.83	13.3	24.8	46.3	66.7	86.4	106	124	143	161	179	197	177	155	138	123	111	101	92.0	84.4	72.1	53.7	6.77	
23	6.11	13.9	26.0	48.6	69.9	90.6	111	131	150	169	188	207	189	166	147	132	119	108	98.3	90.2	77.0	49.5		
24	6.40	14.6	27.2	50.8	73.2	94.9	116	137	157	177	197	216	201	177	157	140	126	115	105	96.2	82.1	44.7		
25	6.69	15.3	28.5	53.1	76.5	99.1	121	143	164	185	206	226	214	188	167	149	134	122	111	102	87.3	39.4		
26	6.98	15.9	29.7	55.4	79.8	103	126	149	171	193	215	236	227	199	177	158	143	129	118	108	86.3	33.4		
28	7.56	17.2	32.2	60.0	86.5	112	137	161	185	209	232	256	251	223	197	177	159	145	132	121	78.2	19.8		
30	8.14	18.6	34.7	64.7	93.2	121	148	174	200	225	250	269	260	247	219	196	177	160	146	125	68.0	3.84		
32	8.73	19.9	37.2	69.4	100	129	158	186	214	242	269	278	268	255	239	216	195	174	147	119	55.7			
35	9.6	21.9	40.9	76.4	110	143	174	205	236	266	296	291	278	262	243	221	195	168	137	105	33.3			
40	11.1	25.3	47.3	88.3	127	165	201	237	273	307	318	306	289	268	243	215	184	150	112	72.6				
45	12.6	28.8	53.7	100	144	187	229	269	310	342	331	314	293	266	235	201	163	121	76.2	28.4				

■RS40B Maximum Kilowatt Ratings Table (kW Ratings for Single Strand Chain)

Lubrication Type Small Sprocket No. of Teeth	Small Sprocket Max rpm																		
	10	15	20	30	40	50	70	100	150	200	250	300	350	400	450	500	550	600	650
	A I			A II			B						C						
9	3.45	4.97	6.44	9.27	12.0	14.7	19.9	27.4	39.5	51.1	62.5	73.7	84.6	89.1	74.7	63.8	55.3	48.5	43.0
10	3.87	5.57	7.21	10.4	13.5	16.5	22.3	30.7	44.2	57.3	70.0	82.5	94.8	101	87.5	74.7	64.7	56.8	50.4
11	4.29	6.17	8.00	11.5	14.9	18.2	24.7	34.0	49.0	63.5	77.6	91.5	105	110	101	86.1	74.7	65.5	58.1
12	4.71	6.78	8.78	12.7	16.4	20.0	27.1	37.4	53.9	69.8	85.3	101	116	118	115	98.2	85.1	74.7	66.2
13	5.13	7.39	9.58	13.8	17.9	21.8	29.6	40.8	58.7	76.1	93.0	110	126	127	122	111	95.9	84.2	74.7
14	5.56	8.01	10.4	14.9	19.4	23.7	32.0	44.2	63.6	82.4	101	119	136	135	130	123	107	94.1	83.4
15	5.99	8.63	11.2	16.1	20.9	25.5	34.5	47.6	68.5	88.8	109	128	145	142	137	129	119	104	92.5
16	6.42	9.25	12.0	17.3	22.4	27.3	37.0	51.0	73.5	95.2	116	137	153	150	144	135	125	112	96.7
17	6.86	9.88	12.8	18.4	23.9	29.2	39.5	54.5	78.5	102	124	146	160	157	150	141	129	115	99.2
18	7.29	10.5	13.6	19.6	25.4	31.0	42.0	57.9	83.5	108	132	156	168	164	157	147	134	119	101
19	7.73	11.1	14.4	20.8	26.9	32.9	44.6	61.4	88.5	115	140	165	175	171	163	152	138	122	103
20	8.17	11.8	15.3	22.0	28.5	34.8	47.1	64.9	93.5	121	148	175	182	177	168	156	142	124	104
21	8.61	12.4	16.1	23.2	30.0	36.7	49.6	68.4	98.6	128	156	184	189	183	174	161	145	126	105
22	9.06	13.0	16.9	24.3	31.5	38.6	52.2	72.0	104	134	164	193	195	189	179	165	148	128	106
23	9.50	13.7	17.7	25.5	33.1	40.5	54.8	75.5	109	141	172	203	202	195	184	169	151	130	106
24	10.0	14.3	18.6	26.7	34.7	42.4	57.3	79.0	114	148	180	210	208	200	188	173	153	131	105
25	10.4	15.0	19.4	28.0	36.2	44.3	59.9	82.6	119	154	188	217	214	205	193	176	155	132	105
26	10.8	15.6	20.2	29.2	37.8	46.2	62.5	86.2	124	161	197	223	219	210	197	179	157	132	104

■RS48B Maximum Kilowatt Ratings Table (kW Ratings for Single Strand Chain)

Lubrication Type Small Sprocket No. of Teeth	Small Sprocket Max rpm																			
	5	10	15	20	25	30	40	50	60	80	100	125	150	175	200	250	300	350	400	450
	A I			A II			B						C							
9	3.35	6.25	9.00	11.7	14.3	16.8	21.8	26.6	31.4	40.6	49.7	60.7	71.5	76.2	78.6	80.5	79.2	75.2	69.0	60.7
10	3.75	7.00	10.1	13.1	16.0	18.8	24.4	29.8	35.1	45.5	55.6	68.0	80.1	84.1	86.6	88.5	86.9	82.3	75.2	65.8
11	4.16	7.76	11.2	14.5	17.7	20.9	27.0	33.0	38.9	50.4	61.7	75.4	87.6	91.7	94.5	96.4	94.4	89.1	81.1	70.6
12	4.57	8.53	12.3	15.9	19.5	22.9	29.7	36.3	42.8	55.4	67.7	82.8	94.9	99.3	102	104	102	95.7	86.7	75.0
13	4.98	9.30	13.4	17.4	21.2	25.0	32.4	39.6	46.6	60.4	73.9	90.3	102	107	110	112	109	102	92.0	79.1
14	5.40	10.1	14.5	18.8	23.0	27.1	35.1	42.9	50.5	65.5	80.0	97.8	109	114	117	119	115	108	97.0	82.9
15	5.82	10.9	15.6	20.3	24.8	29.2	37.8	46.2	54.4	70.5	86.2	105	116	121	124	126	122	114	102	86.3
16	6.24	11.6	16.8	21.7	26.5	31.3	40.5	49.5	58.4	75.6	92.4	113	123	128	132	133	128	119	106	89.4
17	6.66	12.4	17.9	23.2	28.3	33.4	43.3	52.9	62.3	80.7	98.7	121	130	135	138	140	135	125	110	92.2
18	7.08	13.2	19.0	24.7	30.1	35.5	46.0	56.3	66.3	85.9	105	128	136	142	145	146	141	130	114	94.6
19	7.51	14.0	20.2	26.1	32.0	37.7	48.8	59.6	70.3	91.0	111	134	143	149	152	152	146	134	118	96.7
20	7.93	14.8	21.3	27.6	33.8	39.8	51.6	63.0	74.3	96.2	118	141	149	155	158	159	152	139	121	98.5
21	8.36	15.6	22.5	29.1	35.6	42.0	54.4	66.4	78.3	101	124	147	156	162	165	165	157	143	124	100
22	8.80	16.4	23.6	30.6	37.4	44.1	57.2	69.9	82.3	107	130	153	162	168	171	170	162	147	126	101
23	9.23	17.2	24.8	32.1	39.3	46.3	60.0	73.3	86.4	112	137	159	168	174	17					

Kilowatt Ratings Tables (RS56B)

■RS56B Maximum Kilowatt Ratings Table (kW Ratings for Single Strand Chain)

Lubrication Type Small Sprocket No. of Teeth	Small Sprocket Max rpm																			
	5	10	15	20	25	30	40	50	60	80	100	125	150	175	200	250	300	350	400	450
	A I			A II				B									C			
9	5.23	9.76	14.1	18.2	22.3	26.2	34.0	41.5	48.5	55.7	61.0	65.5	68.1	69.0	68.5	64.1	55.8	44.2	29.9	13.2
10	5.86	10.9	15.7	20.4	24.9	29.4	38.1	46.5	53.6	61.6	67.4	72.3	75.0	75.9	75.3	70.1	60.7	47.6	31.5	12.7
11	6.49	12.1	17.5	22.6	27.6	32.6	42.2	51.6	58.7	67.4	73.7	78.9	81.8	82.7	81.9	76.0	65.3	50.8	32.8	11.8
12	7.13	13.3	19.2	24.8	30.4	35.8	46.3	56.7	63.7	73.1	79.8	85.4	88.4	89.3	88.3	81.6	69.7	53.6	33.7	10.6
13	7.78	14.5	20.9	27.1	33.1	39.0	50.5	61.8	68.7	78.7	85.9	91.9	95.0	95.7	94.5	87.0	73.9	56.1	34.3	8.98
14	8.42	15.7	22.6	29.3	35.9	42.3	54.7	66.8	73.6	84.3	91.9	98.2	101	102	101	92.2	77.7	58.3	34.5	6.96
15	9.08	16.9	24.4	31.6	38.6	45.5	59.0	71.3	78.5	89.8	97.9	104	108	108	106	97.2	81.4	60.2	34.4	4.56
16	9.73	18.2	26.2	33.9	41.4	48.8	63.2	75.7	83.3	95.2	104	110	114	114	112	102	84.7	61.8	33.9	1.77
17	10.4	19.4	27.9	36.2	44.2	52.1	67.5	80.0	88.0	101	109	116	120	120	118	106	87.8	63.1	33.1	
18	11.1	20.6	29.7	38.5	47.0	55.4	71.8	84.3	92.8	106	115	122	126	126	123	111	90.7	64.1	32.0	
19	11.7	21.9	31.5	40.8	49.9	58.8	76.1	88.6	97.4	111	121	128	131	131	128	115	93.3	64.8	30.5	
20	12.4	23.1	33.3	43.1	52.7	62.1	80.5	92.9	102	116	126	134	137	137	133	119	95.6	65.2	28.7	
21	13.1	24.4	35.1	45.5	55.6	65.5	84.8	97.0	107	121	132	139	143	142	138	122	97.7	65.3	26.5	
22	13.7	25.6	36.9	47.8	58.4	68.8	89.2	101	111	126	137	145	148	147	143	126	100	65.1	24.0	
23	14.4	26.9	38.7	50.1	61.3	72.2	93.1	105	116	131	142	150	153	152	147	129	101	64.6	21.1	
24	15.1	28.1	40.5	52.5	64.2	75.6	96.7	109	120	136	147	155	158	157	152	132	102	63.8	17.9	
25	15.8	29.4	42.4	54.9	67.1	79.0	100	113	124	141	152	161	163	162	156	135	103	62.7	14.4	
26	16.4	30.7	44.2	57.2	70.0	82.5	104	117	129	146	157	166	168	166	160	138	104	61.3	10.5	

Note: 1. KW rating when using a one-pitch and two-pitch offset link (OL & 2POL) is 80% of the above.
 2. Please contact a Tsubaki representative prior to use of kW ratings in the colored area of the table.

Multi-strand factor	Number of chain strands	Multi-strand factor
	Double strand	1.7
	Triple strand	2.5

Lubrication method	A I	Manual lubrication or drip lubrication	Details on Pg. 202
	A II	Drip lubrication	
	B	Oil bath or slinger disc lubrication	
	C	Forced pump lubrication	

Before Use | Standard Roller Chains | Lube-Free Roller Chains | Heavy Duty Roller Chains | Corrosion Resistant Roller Chains | Specialty Roller Chains | Sprockets | Pin Gear Drives | Accessories | Selection | Handling

Lube-Free Roller Chains



Lambda Chain

Tsubaki is a pioneer in the industry, being the first to develop a chain that uses special oil-impregnated bushes. Since first being introduced in 1988, Lambda Chain has gained an outstanding reputation in a variety of industries and applications. It is capable of meeting a wide range of customer needs for long life in a lubrication-free environment, resulting in a reduction in overall long-term costs.

Uses NSF-H1 food grade lubricant and so can be used on food manufacturing equipment.

Long life without additional lubrication ... Special oil-impregnated bushes provide long service life.

Food grade oil ... Uses NSF-H1 food grade oil in its special sintered bushes.

Interchangeability ... Compatible with standard roller chain, although the kW ratings will differ.

Operating temperature range ... -10°C to 150°C

Sprockets ... Can use RS sprockets (RS Double Strand Compatible)

Basic Construction

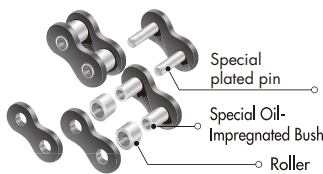

Lambda Chain (standard):

- ▶ Inner/outer plates are blackned
- Lambda Chain (NP Series):
- ▶ Special plating (excluding bushes)

*The inner link plate is one size thicker to ensure tensile strength; therefore, the pins are longer than with general use roller chain. Ensure there will be no interference with equipment when replacing roller chain with Lambda Chain. Available for RS40-RS160

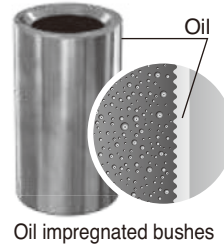

The impregnated oil flows smoothly from pores in the special sintered bushes, creating a uniform oil film layer on the sliding areas that minimizes any breaks in the oil film. The viscosity, molecular weight, and distribution of the oil have all been optimized.

*Image of an oil impregnated bush.

Long Life Lambda Chain (X-Λ[X-Lambda])

The inclusion of an oil-impregnated felt seal in the construction of X-Lambda Chain significantly improves the anti-wear performance of standard Lambda Chain. Ideal for environments where even longer replacement intervals compared to standard Lambda Chain are required.

Ultra long life in a lube-free chain ... The combination of a special oil-impregnated bush and felt seal further extends service life.

Food grade oil ... Uses NSF-H1 food grade oil in its special sintered bushes.

Interchangeability ... Compatible with standard Lambda Chain. However, as the overall pin length is longer than RS Roller Chain and Lambda Chain, please check that there will be no interference with machinery or other equipment.

Operating temperature range ... -10°C to 60°C *Contact a Tsubaki representative regarding use above 60°C.

Sprockets ... Can use RS sprockets (single strand chain only)

Basic Construction

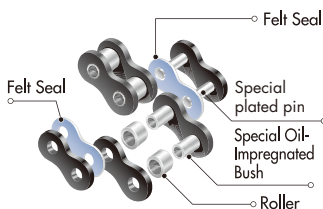

Inner link plates have a black oxide coating.

See pg. 63 for a guide to connecting X-Lambda Chain.

Lambda Chain KF Series (Heat Resistant Series)

Special lubricant demonstrates performance in high temperature environments (150°C to 230°C) and resists degradation. Demonstrates best wear resistance in the high temperature range.

Operating temperature range ... -10°C to 230°C
Note: Best between 150°C to 230°C

Food grade oil ... Special sintered bushes use a high temperature NSF-H1 food grade oil.

⚠ Do not use in environments over 230°C. This will lead to a serious decrease in wear life. Harmful gases may be emitted in temperatures over 280°C.

"KF" stamped on inner plates.

Series Line-up

■ Lambda RS Double Strand Compatible Chain

Can use RS double strand sprockets.

Note: Standard double strand Lambda Chain has a different transverse pitch than standard double strand RS chain and so requires a made-to-order sprocket.

■ BS Lambda Chain (ISO 606 B Series)

Lambda Chain that conforms to ISO 606 B Series. The dimensions are fully interchangeable with existing BS chains. Specially shaped pins are used on single-strand 08B to 16B sizes to enable easy chain disassembly using a standard chain breaker.

■ Surface-Treated Lambda Chain

Standard Lambda Chain with corrosion-resistant surface treatments on the plates and rollers.

NP: Nickel-plated plates and rollers provide mild corrosion resistance.

NEP: A special corrosion-resistant surface treatment is applied to the plates and rollers to improve corrosion resistance.

■ Heavy Duty Lambda Chain

The outer and inner plates are one size thicker than standard Lambda Chain to give the chain the same strength as RS Roller Chain, even in double-strand configuration.

Note: The transverse pitch on standard RS Roller Chain and Lambda Chain differ. Multi-strand sprockets are made-to-order items.

■ Curved Lambda Chain

Lambda Chain with a wide horizontal bending radius thanks to its original pin and bush construction and a large clearance between plates. Curved conveyance can be easily configured using RS standard sprockets.

Comparison of wear life in the high temperature range

A roller chain's wear life varies depending on the chain speed and load acting on it, the number of teeth on the sprocket, operating conditions and temperature, and so on.

The graph below provides a rough guide to roller chain wear life.

*Wear life for Lambda Chain is +0.5% elongation.

150°C Range

*The operating temperature range for Lambda Chain is 150°C.

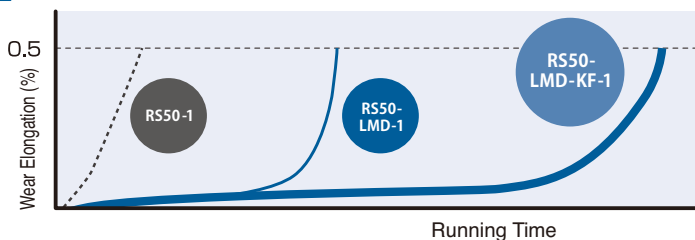

*Kilowatt ratings will drop to 3/4 of the listed catalog values when using in the 150°C - 200°C range. Select a chain to match your operating temperature.

In-house test data for RS50

In-house test comparison with no add. lubrication

230°C Range

*Data in the 230°C range provided for reference only. Do not use Lambda Chain at 230°C.

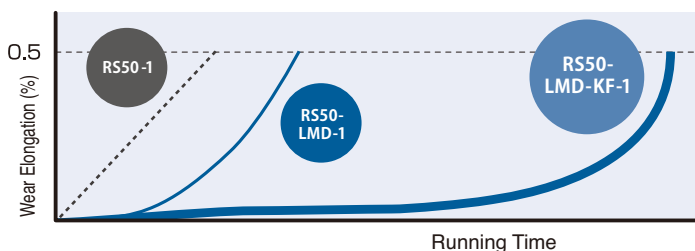

*Kilowatt ratings will drop to 1/2 of the listed catalog values when using in the 200°C - 230°C range. Select a chain to match your operating temperature.

In-house test data for RS50

In-house test comparison with no add. lubrication

⚠ Safety Precautions for Lambda Chain

- Do not use Lambda Chain if the chain will come in direct contact with food or where coating flakes or wear dust can contaminate food. Also, in non-food applications, appropriately cover the chain or contact a Tsubaki representative about chain selection if using in environments where coating flakes or wear dust present problems. Though nickel is not subject to the Japan Food Sanitation Law or the Industrial Safety and Health Law, plating on sliding parts can peel.
 - Lambda Chain uses NSF-H1 non-compliant anti-rust lubrication/assembly oil.
 - Do not use Lambda Chain where there is the possibility of exposure to chemicals, water, or cleaning/degreasing vapors.
- *Be aware that non-NSF-H1 grade anti-rust agent or assembly oil from the manufacturing process may be present on Lambda Chain.

Lambda Chain

Before Use
Standard Roller Chains
Lube-Free Roller Chains
Heavy Duty Roller Chains
Corrosion Resistant Roller Chains
Specialty Roller Chains
Sprockets
Pin Gear Drives
Accessories
Selection
Handling

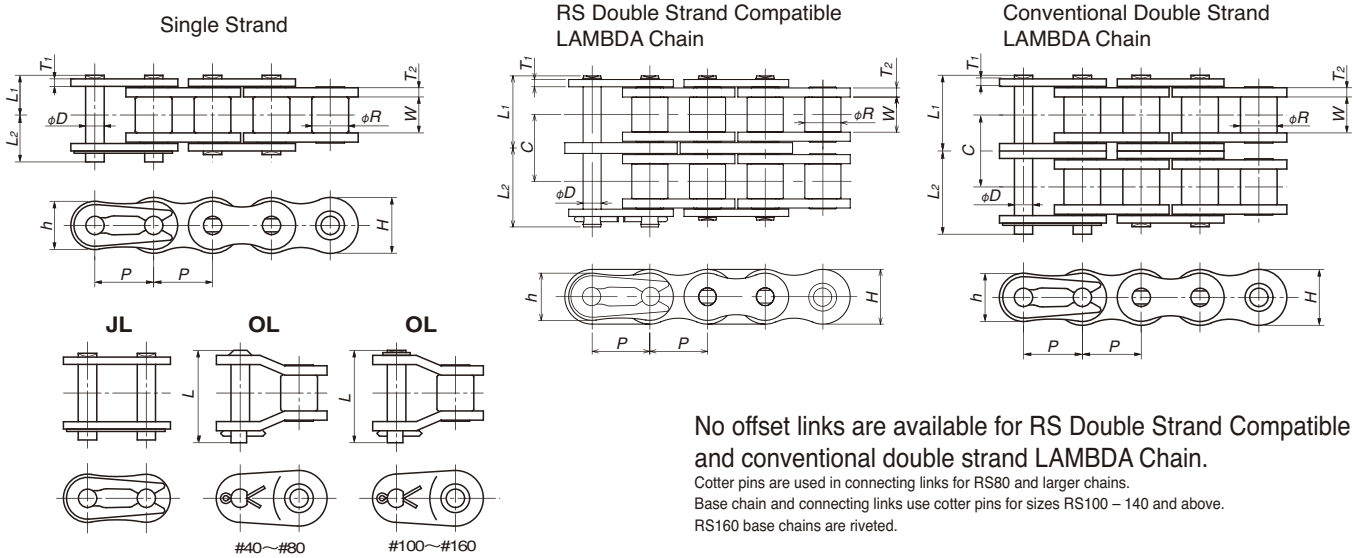

No offset links are available for RS Double Strand Compatible and conventional double strand LAMBDA Chain.

Cotter pins are used in connecting links for RS80 and larger chains.
Base chain and connecting links use cotter pins for sizes RS100 – 140 and above.
RS160 base chains are riveted.

Tsubaki Chain No.			Pitch P	Roller Dia. R	Width Between Inner Link Plates W	Plate				Pin			Offset Pin Length L
Single Strand	RS Compatible	Conventional Double Strand				Thickness T ₁	Thickness T ₂	Height H	Height h	Values in () are for RS Double Strand Compatible chain	Dia. D	L ₁	
RS40-LMD-1	RS40-LMD-S-2	RS40-LMD-2	12.70	7.92	7.55	1.5	2.0	12.0	10.4	3.97	8.75 (15.95)	10.45 (17.65)	20.0
RS50-LMD-1	RS50-LMD-S-2	RS50-LMD-2	15.875	10.16	9.26	2.0	2.4	15.0	13.0	5.09	10.75 (19.85)	12.45 (21.55)	24.0
RS60-LMD-1	RS60-LMD-S-2	RS60-LMD-2	19.05	11.91	12.28	2.4	3.2	18.1	15.6	5.96	13.70 (25.15)	15.70 (26.95)	32.0
RS80-LMD-1	RS80-LMD-S-2	RS80-LMD-2	25.40	15.88	15.48	3.2	4.0	24.1	20.8	7.94	17.15 (31.75)	20.25 (34.75)	39.9
RS100-LMD-1	RS100-LMD-S-2	RS100-LMD-2	31.75	19.05	18.70	4.0	4.8	30.1	26.0	9.54	20.65 (38.50)	23.85 (41.60)	47.5
RS120-LMD-1	RS120-LMD-S-2		38.10	22.23	24.75	4.8	5.6	36.2	31.2	11.11	25.75 (48.55)	29.95 (52.55)	59.0
RS140-LMD-1	RS140-LMD-S-2		44.45	25.40	24.75	5.6	6.4	42.2	36.4	12.71	27.70 (52.20)	32.20 (56.60)	63.7
RS160-LMD-1	RS160-LMD-S-2		50.80	28.58	31.2	6.4	7.15	48.2	41.6	14.29	32.75 (62.05)	37.65 (66.85)	74.1

Tsubaki Chain No.			Min. Tensile Strength kN {kgf}			Approx. Mass (kg/m)	No. of Links per Unit	Allowable Speed (m/min)	Transverse Pitch C	
Single Strand	RS Compatible	Conventional Double Strand	Single Strand	RS Compatible	Conventional Double Strand				RS Compatible	Conventional Double Strand
RS40-LMD-1	RS40-LMD-S-2	RS40-LMD-2	17.7 {1800}	30.0 {3060}	35.3 {3600}	0.70 (1.4)	240	150	14.4	15.4
RS50-LMD-1	RS50-LMD-S-2	RS50-LMD-2	28.4 {2900}	48.3 {4930}	56.9 {5800}	1.11 (2.2)	192	135	18.1	19.0
RS60-LMD-1	RS60-LMD-S-2	RS60-LMD-2	40.2 {4100}	68.4 {6970}	80.4 {8200}	1.72 (3.4)	160	120	22.8	24.52
RS80-LMD-1	RS80-LMD-S-2	RS80-LMD-2	71.6 {7300}	122 {12400}	143 {14600}	2.77 (5.5)	120	90	29.3	31.1
RS100-LMD-1	RS100-LMD-S-2	RS100-LMD-2	107 {10900}	181 {18500}	214 {21800}	4.30 (8.6)	96	80	35.8	37.6
RS120-LMD-1	RS120-LMD-S-2		148 {15000}	252 {25700}		6.4 (13.0)	80	50	45.4	
RS140-LMD-1	RS140-LMD-S-2		193 {19700}	329 {33500}		8.1 (16.5)	68	50	48.9	
RS160-LMD-1	RS160-LMD-S-2		255 {26000}	433 {44200}		10.5 (21.4)	60	50	58.5	

- Note: 1. No offset links available for RS Double Strand Compatible and conventional double strand chain. Use an even number of links.
2. All other models are made-to-order.
3. RS Double Strand Compatible chain uses an RF type plate for the middle plate. RS40 – RS100 use one middle plate, while RS120 – RS160 use two.
4. Contact a Tsubaki representative regarding the pin length (L₁, L₂) and approximate mass for conventional double strand LAMBDA Chain.
5. The dimensions given above are nominal dimensions. Actual dimensions may vary slightly.

Operating Temperature Range: –10°C to 150°C

Precautions for Use

- Debris in the bushes accelerates wear. Wet environments can cause the oil in the oil-impregnated bushes to leak out. Chain is coated with less rust-prevention oil than those for RS Roller Chain, which may lead to premature rusting.
- Bush oil can leak out in a vacuum, decreasing wear resistance. Do not use in a vacuum. Contact a Tsubaki representative when considering a chain that can be used in a vacuum.
- Chain life will decrease dramatically if oil in the oil-impregnated bushes is depleted.
- The multi-strand factor for RS Double Strand Compatible chain is 1.7. Recalculate the kW ratings for LAMBDA Chain when replacing RS Roller Chain. The multi-strand factor for conventional double strand LAMBDA Chain was 1.4.
- RS Double Strand Compatible chain can use RS Sprockets. Conventional double strand LAMBDA Chain requires special sprockets. Contact a Tsubaki representative for more information.

■ LAMBDA Chain has a longer pin length (L₁, L₂) than RS Roller Chain. Ensure there will be no interference with the equipment.

NP Series

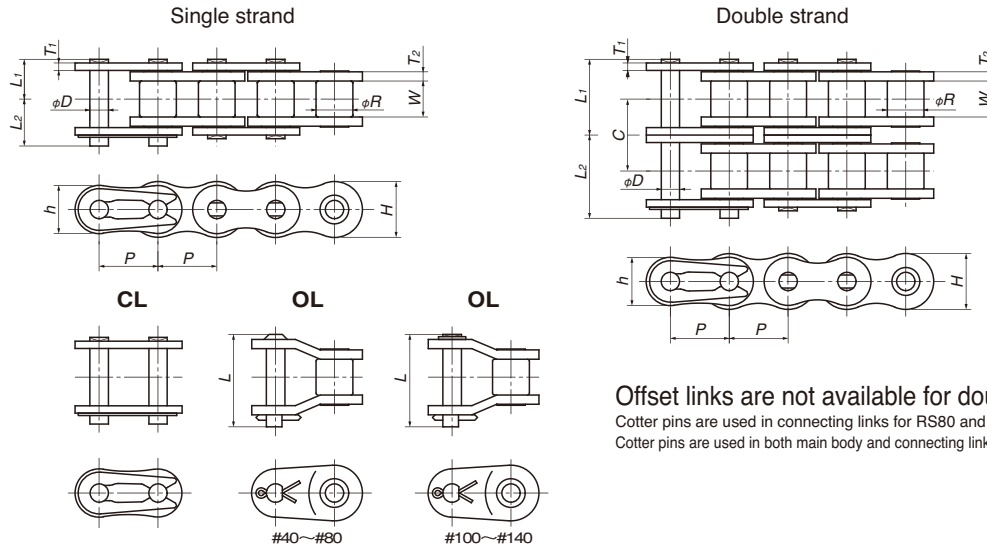

Offset links are not available for double strand.

Cotter pins are used in connecting links for RS80 and larger size chains.
Cotter pins are used in both main body and connecting links for RS100 and large chains.

TSUBAKI Chain Number		Pitch P	Roller Diameter R	Inner Width of Inner Link W	Plates				Diameter D	Pins		Offset Pin Length L
Single-strand	Double-strand				Thickness T1	Thickness T2	Height H	Height h		L1 2-strand value in ()	L2 2-strand value in ()	
RS40-LMD-NP-1	RS40-LMD-NP-2	12.70	7.92	7.55	1.5	2.0	12.0	10.4	3.97	8.75 (16.5)	10.45 (18.1)	20.0
RS50-LMD-NP-1	RS50-LMD-NP-2	15.875	10.16	9.26	2.0	2.4	15.0	13.0	5.09	10.75 (20.2)	12.45 (22.0)	24.0
RS60-LMD-NP-1	RS60-LMD-NP-2	19.05	11.91	12.28	2.4	3.2	18.1	15.6	5.96	13.70 (26.05)	15.70 (28.05)	32.0
RS80-LMD-NP-1	RS80-LMD-NP-2	25.40	15.88	15.48	3.2	4.0	24.1	20.8	7.94	17.15 (32.7)	20.25 (35.9)	39.9
RS100-LMD-NP-1	RS100-LMD-NP-2	31.75	19.05	18.70	4.0	4.8	30.1	26.0	9.54	20.65 (39.5)	23.85 (42.5)	47.5
RS120-LMD-NP-1		38.10	22.23	24.75	4.8	5.6	36.2	31.2	11.11	25.75	29.95	59.0
RS140-LMD-NP-1		44.45	25.40	24.75	5.6	6.4	42.2	36.4	12.71	27.70	32.20	63.7

TSUBAKI Chain Number		Minimum Tensile Strength kN {kgf} 2-strand value in ()	Approximate Mass kg/m 2-strand value in ()	Links Per Unit	Allowable Speed m/min	Transverse Pitch C
Single-strand	Double-strand					
RS40-LMD-NP-1	RS40-LMD-NP-2	17.7 {1800}	(35.3 {3600})	240	150	15.4
RS50-LMD-NP-1	RS50-LMD-NP-2	28.4 {2900}	(56.9 {5800})	192	135	19.0
RS60-LMD-NP-1	RS60-LMD-NP-2	40.2 {4100}	(80.4 {8200})	160	120	24.52
RS80-LMD-NP-1	RS80-LMD-NP-2	71.6 {7300}	(143 {14600})	120	90	31.1
RS100-LMD-NP-1	RS100-LMD-NP-2	107 {10900}	(214 {21800})	96	80	37.6
RS120-LMD-NP-1		148 {15000}		80	50	
RS140-LMD-NP-1		193 {19700}		68	50	

- Note 1. Offset links are not available for double strand chain. Use an even number of links.
 2. Items in bold are stocked in units. All other items are made-to-order.
 3. Contact a Tsubaki representative regarding NP Series RS160-LMD and RS Double Strand Compatible chains.
 4. The dimensions shown in this catalog are nominal dimensions and differ from actual dimensions.

⚠ Nickel-plated series

Do not use nickel-plated chain if the chain will come in direct contact with food or where coating flakes or wear dust can contaminate food. Also, in non-food applications, appropriately cover the chains or contact Tsubaki about chain selection if using in environments where coating flakes and wear dust present problems. Though nickel is not subject to the Food Sanitation Law or the Industrial Safety and Health Law, plating on sliding parts can peel.

X-Lambda Chain (X-Λ)

Single strand

CL

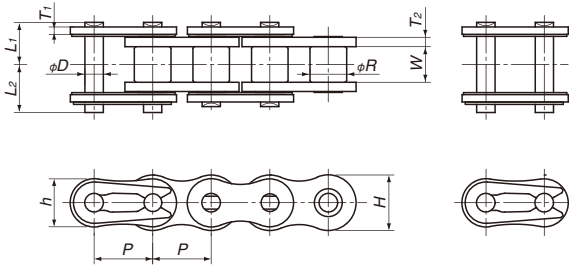

Offset links are not available with X-Lambda Chains.

Cotter pins are used in connecting links for RS80 and larger size chains.

Cotter pins are used in both main body and connecting links for RS100 and large chains.

TSUBAKI Chain Number	Pitch P	Roller Diameter R	Inner Width of Inner Link W	Plates				Pins		
				Thickness T1	Thickness T2	Height H	Height h	Diameter D	L1	L2
RS40-LMDX-1	12.70	7.92	7.55	1.5	2.0	12.0	10.4	3.97	9.4	11.1
RS50-LMDX-1	15.875	10.16	9.26	2.0	2.4	15.0	13.0	5.09	11.4	13.1
RS60-LMDX-1	19.05	11.91	12.28	2.4	3.2	18.1	15.6	5.96	14.8	16.5
RS80-LMDX-1	25.40	15.88	15.48	3.2	4.0	24.1	20.8	7.94	18.3	20.9
RS100-LMDX-1	31.75	19.05	18.70	4.0	4.8	30.1	26.0	9.54	21.8	24.5
RS120-LMDX-1	38.10	22.23	24.75	4.8	5.6	36.2	31.2	11.11	26.7	30.8

TSUBAKI Chain Number	Minimum Tensile Strength kN {kgf}	Approximate Mass kg/m	Number of Links Per Unit	Allowable Speed m/min
RS40-LMDX-1	17.7 {1800}	0.70	240	150
RS50-LMDX-1	28.4 {2900}	1.11	192	135
RS60-LMDX-1	40.2 {4100}	1.72	160	120
RS80-LMDX-1	71.6 {7300}	2.77	120	90
RS100-LMDX-1	107 {10900}	4.30	96	80
RS120-LMDX-1	148 {15000}	6.40	80	50

Note: The dimensions shown in this catalog are nominal dimensions and differ from actual dimensions.

Operating temperature range : -10 to 60°C (*Contact a Tsubaki representative regarding use above 60°C.)

Made-to-order item.

Precautions for use

- Because of its felt seals and inner plates that are thicker than RS Roller Chain's inner plates, the pins are longer (L1 and L2). Check for equipment interference.
- Offset links are not available for X-Lambda Chains. Chains should be designed with an even number of links.
- Due to oil in the felt seal, more oil adheres to the surface of X-Lambda Chains than regular Lambda Chains.

Connecting

Use a connecting link (with felt seal) to connect X-Lambda Chains. Set the felt seals on the inside of both the outer plate and connecting plate (Fig.1). (For chain connecting instructions, see pg. 200.)

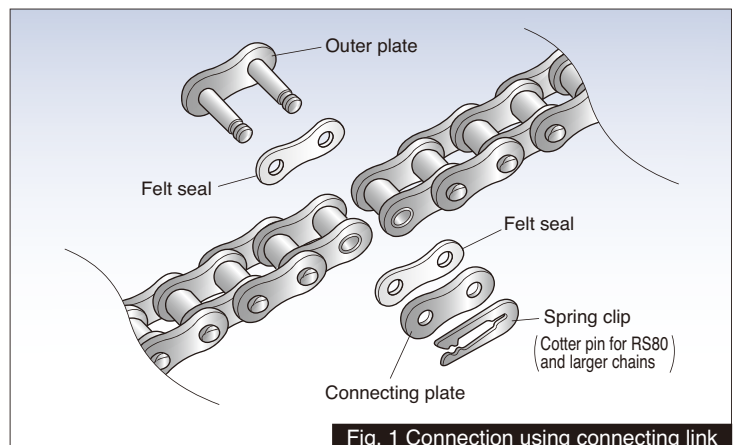
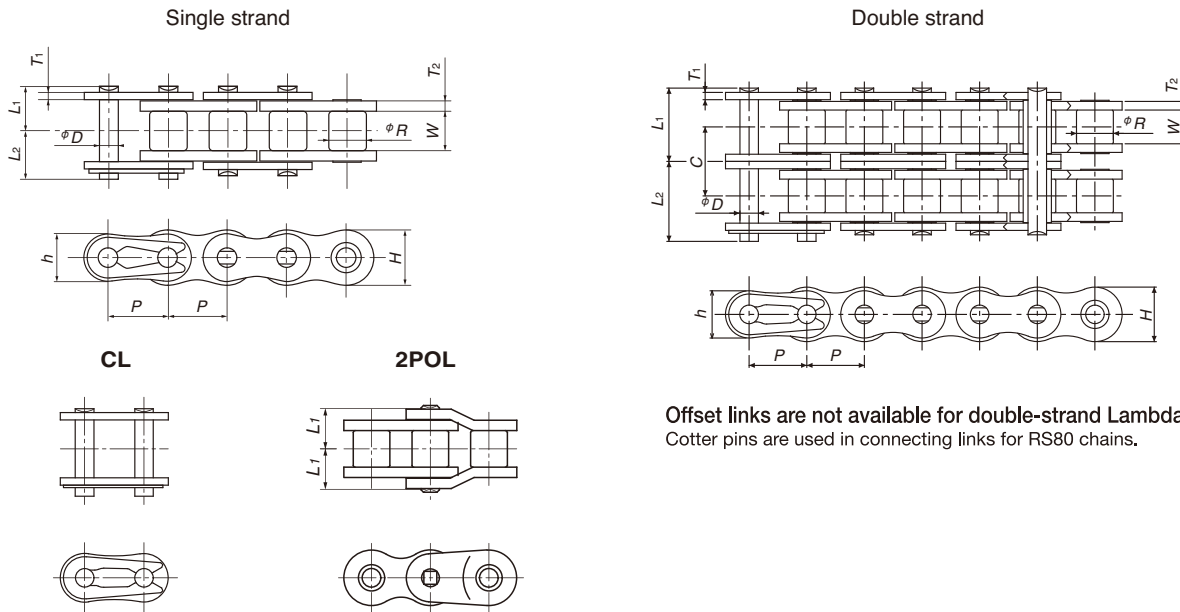

Fig. 1 Connection using connecting link

Lambda Chain KF Series (Heat Resistant Series)



Offset links are not available for double-strand Lambda Chain. Cotter pins are used in connecting links for RS80 chains.

Tsubaki Chain No.		Pitch P	Roller Dia. R	Width Between Inner Link Plates W	Plate				Pin		
Single Strand	Double Strand				Thickness T1	Thickness T2	Height H	Height h	Dia. D	L1 2-strand value in ()	L2 2-strand value in ()
RS40-LMD-KF-1	RS40-LMD-KF-2	12.70	7.92	7.55	1.5	2.0	12.0	10.4	3.97	8.75 (16.5)	10.45 (18.1)
RS50-LMD-KF-1	RS50-LMD-KF-2	15.875	10.16	9.26	2.0	2.4	15.0	13.0	5.09	10.75 (20.2)	12.45 (22.0)
RS60-LMD-KF-1	RS60-LMD-KF-2	19.05	11.91	12.28	2.4	3.2	18.1	15.6	5.96	13.70 (26.05)	15.70 (28.05)
RS80-LMD-KF-1	RS80-LMD-KF-2	25.40	15.88	15.48	3.2	4.0	24.1	20.8	7.94	17.15 (32.7)	20.25 (35.9)

Tsubaki Chain No.		Minimum Tensile Strength kN { kgf } 2-strand value in ()	Approximate Mass kg/m 2-strand value in ()	No. of Links per Unit	Allowable Speed (m/min)	Transverse Pitch C
Single Strand	Double Strand					
RS40-LMD-KF-1	RS40-LMD-KF-2	17.7{1800} { 35.3{3600} }	0.70 (1.4)	240	150	15.4
RS50-LMD-KF-1	RS50-LMD-KF-2	28.4{2900} { 56.9{5800} }	1.11 (2.2)	192	135	19.0
RS60-LMD-KF-1	RS60-LMD-KF-2	40.2{4100} { 80.4{8200} }	1.72 (3.4)	160	120	24.52
RS80-LMD-KF-1	RS80-LMD-KF-2	71.6{7300} { 143{14600} }	2.77 (5.5)	120	90	31.1

- Note 1. Offset links are not available for double strand chain. Use an even number of links.
 2. Offset links for single-stand chain use special numbering only for double-pitch offset links.
 3. The dimensions shown in this catalog are nominal dimensions and differ from actual dimensions.

Selection

- Select KF Series Lambda Chain by multiplying the temperature factor of the operating environment and the kW ratings. Calculate the temperature factor as the maximum operating temperature of the equipment being used. This selection method anticipates a drop in strength in relation to the temperature.

Temperature factors for operating environment

Temperature	kW ratings
Ambient temperature to 150°C	kW ratings (pg. 65) x 1
150°C to 200°C	kW ratings (pg. 65) x 3/4
200°C to 230°C	kW ratings (pg. 65) x 1/2

Precautions for Use

- The kW ratings of double strand Lambda Chain include a multi-strand coefficient factor of 1.4.
- Double strand Lambda Chain pin length
 Because the inner plates are thicker than those of RS Roller Chain, the pins are longer by an equal amount (L1, L2). Ensure that there will be no interference with equipment. Double strand Lambda Chain cannot use double strand RS sprockets. Made-to-order sprockets are required.
- Made-to-order item.
- Wear life will markedly decrease in temperatures over 230°C. Further, there is a danger of harmful gases being released in temperatures over 280°C. Do not use above 280°C.

Kilowatt Ratings Tables (Lambda Chain / Surface Treated Lambda Chain / X-Lambda Chain / Lambda Chain KF Series)

■RS40-LMD-1 Maximum Kilowatt Ratings Table (kW Ratings for Single Strand Chain)

Small sprocket number of teeth	Small Sprocket Max rpm											
	10	25	50	100	200	300	400	500	700	900	1000	1200
9	0.05	0.11	0.21	0.39	0.72	1.04	1.35	1.65	2.23	2.79	3.07	3.62
10	0.05	0.12	0.23	0.43	0.81	1.16	1.51	1.84	2.50	3.13	3.44	
11	0.06	0.14	0.26	0.48	0.90	1.29	1.67	2.04	2.77	3.47	3.81	
12	0.07	0.15	0.28	0.53	0.98	1.42	1.84	2.24	3.04	3.81		
13	0.07	0.17	0.31	0.57	1.07	1.55	2.00	2.45	3.31	4.15		
14	0.08	0.18	0.33	0.62	1.16	1.67	2.17	2.65	3.59			
15	0.08	0.19	0.36	0.67	1.25	1.80	2.34	2.86	3.87			
16	0.09	0.21	0.39	0.72	1.34	1.93	2.51	3.06	4.15			
17	0.10	0.22	0.41	0.77	1.43	2.06	2.67	3.27				
18	0.10	0.23	0.44	0.82	1.52	2.20	2.84	3.48				
19	0.11	0.25	0.46	0.87	1.62	2.33	3.02	3.69				
20	0.12	0.26	0.49	0.92	1.71	2.46	3.19	3.90				
21	0.12	0.28	0.52	0.97	1.80	2.59	3.36	4.11				
22	0.13	0.29	0.54	1.01	1.89	2.73	3.53	4.32				
23	0.13	0.31	0.57	1.06	1.99	2.86	3.71	4.53				
24	0.14	0.32	0.60	1.11	2.08	3.00	3.88					
25	0.15	0.33	0.62	1.16	2.17	3.13	4.06					
26	0.15	0.35	0.65	1.22	2.27	3.27	4.23					
28	0.17	0.38	0.71	1.32	2.46	3.54	4.58					
30	0.18	0.41	0.76	1.42	2.65	3.81						
32	0.19	0.44	0.82	1.52	2.84	4.09						
35	0.21	0.48	0.90	1.68	3.13	4.50						
40	0.24	0.56	1.04	1.94	3.61							
45	0.28	0.63	1.18	2.20	4.10							

■RS50-LMD-1 Maximum Kilowatt Ratings Table (kW Ratings for Single Strand Chain)

Small sprocket number of teeth	Small Sprocket Max rpm											
	10	25	50	100	200	300	400	500	600	700	800	900
9	0.10	0.23	0.43	0.80	1.49	2.15	2.78	3.40	4.01	4.61	5.19	5.77
10	0.11	0.26	0.48	0.90	1.67	2.41	3.12	3.81	4.49	5.16	5.82	
11	0.12	0.29	0.53	0.99	1.85	2.67	3.46	4.23	4.98	5.72		
12	0.14	0.31	0.58	1.09	2.03	2.93	3.80	4.64	5.47	6.28		
13	0.15	0.34	0.64	1.19	2.22	3.20	4.14	5.06	5.96			
14	0.16	0.37	0.69	1.29	2.40	3.46	4.49	5.48	6.46			
15	0.17	0.40	0.74	1.39	2.59	3.73	4.83	5.91				
16	0.19	0.43	0.80	1.49	2.78	4.00	5.18	6.33				
17	0.20	0.46	0.85	1.59	2.96	4.27	5.53	6.76				
18	0.21	0.49	0.91	1.69	3.15	4.54	5.88					
19	0.23	0.51	0.96	1.79	3.34	4.81	6.24					
20	0.24	0.54	1.01	1.89	3.53	5.09	6.59					
21	0.25	0.57	1.07	2.00	3.72	5.36	6.95					
22	0.26	0.60	1.12	2.10	3.92	5.64						
23	0.28	0.63	1.18	2.20	4.11	5.92						
24	0.29	0.66	1.24	2.31	4.30	6.20						
25	0.30	0.69	1.29	2.41	4.50	6.48						
26	0.32	0.72	1.35	2.51	4.69	6.76						
28	0.34	0.78	1.46	2.72	5.08	7.32						
30	0.37	0.84	1.57	2.93	5.47							
32	0.40	0.90	1.69	3.15	5.87							
35	0.44	1.00	1.86	3.46	6.47							
40	0.50	1.15	2.14	4.00	7.47							
45	0.57	1.31	2.44	4.55								

■RS60-LMD-1 Maximum Kilowatt Ratings Table (kW Ratings for Single Strand Chain)

Small sprocket number of teeth	Small Sprocket Max rpm											
	10	25	50	100	150	200	250	300	400	500	600	700
9	0.18	0.41	0.76	1.41	2.03	2.64	3.22	3.80	4.92	6.01	7.08	8.14
10	0.20	0.45	0.85	1.58	2.28	2.95	3.61	4.25	5.51	6.74	7.94	
11	0.22	0.50	0.94	1.75	2.53	3.27	4.00	4.71	6.11	7.47		
12	0.24	0.55	1.03	1.93	2.78	3.60	4.40	5.18	6.71	8.20		
13	0.26	0.60	1.13	2.10	3.03	3.92	4.79	5.65	7.32			
14	0.29	0.65	1.22	2.28	3.28	4.25	5.19	6.12	7.92			
15	0.31	0.70	1.31	2.45	3.53	4.58	5.59	6.59	8.54			
16	0.33	0.75	1.41	2.63	3.79	4.91	6.00	7.07				
17	0.35	0.81	1.50	2.81	4.04	5.24	6.40	7.54				
18	0.38	0.86	1.60	2.99	4.30	5.57	6.81	8.02				
19	0.40	0.91	1.70	3.16	4.56	5.91	7.22	8.51				
20	0.42	0.96	1.79	3.35	4.82	6.24	7.63	8.99				
21	0.44	1.01	1.89	3.53	5.08	6.58	8.04	9.48				
22	0.47	1.06	1.99	3.71	5.34	6.92	8.46					
23	0.49	1.12	2.08	3.89	5.60	7.26	8.87					
24	0.51	1.17	2.18	4.07	5.87	7.60	9.29					
25	0.54	1.22	2.28	4.26	6.13	7.94	9.71					
26	0.56	1.28	2.38	4.44	6.40	8.29						
28	0.61	1.38	2.58	4.81	6.93	8.98						
30	0.65	1.49	2.78	5.18	7.47	9.67						
32	0.70	1.60	2.98	5.56	8.00							
35	0.77	1.76	3.28	6.12	8.82							
40	0.89	2.03	3.79	7.07	10.2							
45	1.01	2.31	4.30	8.03								

■RS80-LMD-1 Maximum Kilowatt Ratings Table (kW Ratings for Single Strand Chain)

Small sprocket number of teeth	Small Sprocket Max rpm											
	10	25	50	75	100	125	150	200	250	300	350	
9	0.40	0.91	1.69	2.44	3.16	3.86	4.55	5.90	7.21	8.50	9.76	
10	0.45	1.02	1.90	2.73	3.54	4.33	5.10	6.61	8.08	9.52	10.9	
11	0.49	1.13	2.10	3.03	3.93	4.80	5.66	7.33	8.96	10.6		
12	0.54	1.24	2.31	3.33	4.31	5.27	6.21	8.05	9.84			
13	0.59	1.35	2.52	3.63	4.70	5.75	6.77	8.78	10.7			
14	0.64	1.46	2.73	3.93	5.10	6.23	7.34	9.51	11.6			
15	0.69	1.58	2.94	4.24	5.49	6.71	7.91	10.2				
16	0.74	1.69	3.15	4.54	5.89	7.19	8.48	11.0				
17	0.79	1.80	3.37	4.85	6.28	7.68	9.05	11.7				
18	0.84	1.92	3.58	5.16	6.68	8.17	9.63					
19	0.89	2.03	3.80	5.47	7.09	8.66	10.2					
20	0.94	2.15	4.01	5.78	7.49	9.16	10.8					
21	0.99	2.27	4.23	6.09	7.89	9.65	11.4					
22	1.05	2.38	4.45	6.41	8.30	10.1	12.0					
23	1.10	2.50	4.67	6.72	8.71	10.6	12.5					
24	1.15	2.62	4.89	7.04	9.12	11.1						
25	1.20	2.74	5.11	7.36	9.53	11.7						
26	1.25	2.86	5.33	7.67	9.94	12.2						
28	1.36	3.09	5.77	8.31	10.8	13.2						
30	1.46	3.33	6.22	8.96	11.6							
32	1.57	3.57	6.67	9.60	12.4							
35	1.73	3.94	7.35	10.6	13.7							
40	1.99	4.55	8.48	12.2								
45	2.26	5.16	9.64	13.9								

- Note 1. kW ratings when using a one-pitch offset link (OL) are 80% of the above values.
 2. The kW ratings of double strand Lambda Chain include a multi-strand coefficient factor of 1.4.
 3. X-Lambda Chain uses the kW ratings shown here.
 4. The kW ratings table for RS Roller Chain differs from the above.
 5. Select KF Series Lambda Chain by kW rating with temperature selection from the operating temperature included.

Kilowatt Ratings Tables (Lambda Chain / Surface Treated Lambda Chain / X-Lambda Chain / Lambda Chain KF Series)

■RS100-LMD-1 Maximum Kilowatt Ratings Table
(kW Ratings for Single Strand Chain)

Small sprocket number of teeth	Small Sprocket Max rpm											
	10	25	50	75	100	125	150	175	200	225	250	275
9	0.66	1.51	2.82	4.07	5.27	6.44	7.59	8.72	9.83	10.9	12.0	13.1
10	0.74	1.70	3.16	4.56	5.90	7.22	8.51	9.77	11.0	12.3	13.5	
11	0.82	1.88	3.51	5.05	6.54	8.00	9.43	10.8	12.3	13.4		
12	0.91	2.06	3.85	5.55	7.19	8.79	10.4	11.9	13.4			
13	0.99	2.25	4.20	6.05	7.84	9.58	11.3	13.0				
14	1.07	2.44	4.55	6.56	8.49	10.4	12.2	14.1				
15	1.15	2.63	4.90	7.06	9.15	11.2	13.2					
16	1.23	2.82	5.26	7.57	9.81	12.0	14.1					
17	1.32	3.01	5.61	8.08	10.5	12.8						
18	1.40	3.20	5.97	8.60	11.1	13.6						
19	1.49	3.39	6.33	9.12	11.8	14.4						
20	1.57	3.58	6.69	9.64	12.5	15.3						
21	1.66	3.78	7.05	10.2	13.2							
22	1.74	3.97	7.41	10.7	13.8							
23	1.83	4.17	7.78	11.2	14.5							
24	1.91	4.36	8.15	11.7	15.2							
25	2.00	4.56	8.51	12.3	15.9							
26	2.09	4.76	8.88	12.8								
28	2.26	5.16	9.62	13.9								
30	2.43	5.55	10.4	14.9								
32	2.61	5.96	11.1	16.0								
35	2.88	6.56	12.2									
40	3.32	7.58	14.1									
45	3.77	8.61	16.1									

■RS120-LMD-1 Maximum Kilowatt Ratings Table
(kW Ratings for Single Strand Chain)

Small sprocket number of teeth	Small Sprocket Max rpm											
	5	10	15	20	25	30	40	50	60	80	100	125
9	0.65	1.22	1.75	2.27	2.77	3.27	4.23	5.17	6.10	7.90	9.65	11.8
10	0.73	1.36	1.96	2.54	3.11	3.66	4.74	5.80	6.83	8.85	10.8	13.2
11	0.81	1.51	2.17	2.82	3.44	4.06	5.25	6.43	7.57	9.81	12.0	
12	0.89	1.66	2.39	3.09	3.78	4.46	5.77	7.06	8.32	10.8	13.2	
13	0.97	1.81	2.60	3.37	4.12	4.86	6.29	7.70	9.07	11.7	14.4	
14	1.05	1.96	2.82	3.65	4.47	5.26	6.82	8.34	9.82	12.7		
15	1.13	2.11	3.04	3.94	4.81	5.67	7.35	8.98	10.6	13.7		
16	1.21	2.26	3.26	4.22	5.16	6.08	7.88	9.63	11.3	14.7		
17	1.29	2.42	3.48	4.51	5.51	6.49	8.41	10.3	12.1			
18	1.38	2.57	3.70	4.79	5.86	6.91	8.94	10.9	12.9			
19	1.46	2.72	3.92	5.08	6.21	7.32	9.48	11.6	13.7			
20	1.54	2.88	4.15	5.37	6.57	7.74	10.0	12.3	14.4			
21	1.63	3.03	4.37	5.66	6.92	8.16	10.6	12.9	15.2			
22	1.71	3.19	4.60	5.95	7.28	8.58	11.1	13.6				
23	1.79	3.35	4.82	6.25	7.64	9.00	11.7	14.3				
24	1.88	3.51	5.05	6.54	8.00	9.42	12.2	14.9				
25	1.96	3.66	5.28	6.84	8.36	9.85	12.8	15.6				
26	2.05	3.82	5.51	7.13	8.72	10.3	13.3	16.3				
28	2.22	4.14	5.96	7.72	9.45	11.1	14.4					
30	2.39	4.46	6.43	8.32	10.2	12.0	15.5					
32	2.56	4.78	6.89	8.92	10.9	12.9	16.7					
35	2.82	5.27	7.59	9.83	12.0	14.2						
40	3.26	6.09	8.77	11.4	13.9	16.4						
45	3.70	6.91	9.96	12.9	15.8							

■RS140-LMD-1 Maximum Kilowatt Ratings Table
(kW Ratings for Single Strand Chain)

Small sprocket number of teeth	Small Sprocket Max rpm											
	5	10	15	20	25	30	40	50	60	80	100	125
9	1.02	1.90	2.74	3.55	4.34	5.12	6.63	8.10	9.55	12.4	15.1	18.5
10	1.14	2.13	3.07	3.98	4.87	5.73	7.43	9.08	10.7	13.9	16.9	
11	1.27	2.36	3.41	4.41	5.39	6.36	8.23	10.1	11.9	15.4	18.8	
12	1.39	2.60	3.74	4.85	5.93	6.98	9.05	11.1	13.0	16.9		
13	1.52	2.83	4.08	5.29	6.46	7.61	9.86	12.1	14.2	18.4		
14	1.64	3.07	4.42	5.73	7.00	8.25	10.7	13.1	15.4	19.9		
15	1.77	3.31	4.76	6.17	7.54	8.89	11.5	14.1	16.6			
16	1.90	3.54	5.11	6.61	8.08	9.53	12.3	15.1	17.8			
17	2.03	3.78	5.45	7.06	8.63	10.2	13.2	16.1	19.0			
18	2.16	4.03	5.80	7.51	9.18	10.8	14.0	17.1	20.2			
19	2.29	4.27	6.15	7.96	9.73	11.5	14.9	18.2				
20	2.42	4.51	6.50	8.42	10.3	12.1	15.7	19.2				
21	2.55	4.75	6.85	8.87	10.8	12.8	16.6	20.2				
22	2.68	5.00	7.20	9.33	11.4	13.4	17.4	21.3				
23	2.81	5.25	7.55	9.79	12.0	14.1	18.3					
24	2.94	5.49	7.91	10.2	12.5	14.8	19.1					
25	3.08	5.74	8.27	10.7	13.1	15.4	20.0					
26	3.21	5.99	8.62	11.2	13.7	16.1	20.8					
28	3.48	6.49	9.34	12.1	14.8	17.4	22.6					
30	3.74	6.99	10.1	13.0	15.9	18.8						
32	4.02	7.49	10.8	14.0	17.1	20.1						
35	4.42	8.25	11.9	15.4	18.8	22.2						
40	5.11	9.53	13.7	17.8	21.7							

■RS160-LMD-1 Maximum Kilowatt Ratings Table
(kW Ratings for Single Strand Chain)

Small sprocket number of teeth	Small Sprocket Max rpm											
	5	10	15	20	25	30	40	50	60	80	100	
9	1.54	2.87	4.13	5.35	6.54	7.70	9.98	12.2	14.4	18.6	22.8	
10	1.72	3.21	4.63	5.99	7.33	8.63	11.2	13.7	16.1	20.9		
11	1.91	3.56	5.13	6.64	8.12	9.57	12.4	15.2	17.9	23.1		
12	2.10	3.91	5.63	7.30	8.92	10.5	13.6	16.6	19.6	25.4		
13	2.28	4.26	6.14	7.96	9.73	11.5	14.8	18.1	21.4			
14	2.48	4.62	6.65	8.62	10.5	12.4	16.1	19.7	23.2			
15	2.67	4.98	7.17	9.29	11.4	13.4	17.3	21.2	25.0			
16	2.86	5.34	7.68	9.96	12.2	14.3	18.6	22.7	26.8			
17	3.05	5.70	8.20	10.6	13.0	15.3	19.8	24.2				
18	3.25	6.06	8.73	11.3	13.8	16.3	21.1	25.8				
19	3.44	6.42	9.25	12.0	14.7	17.3	22.4	27.3				
20	3.64	6.79	9.78	12.7	15.5	18.2	23.6					
21	3.83	7.16	10.3	13.4	16.3	19.2	24.9					
22	4.03	7.52	10.8	14.0	17.2	20.2	26.2					
23	4.23	7.90	11.4	14.7	18.0	21.2	27.5					
24	4.43	8.27	11.9	15.4	18.9	22.2	28.8					
25	4.63	8.64	12.4	16.1	19.7	23.2						
26	4.83	9.01	13.0	16.8	20.6	24.2						
28	5.23	9.76	14.1	18.2	22.3	26.2						
30	5.64	10.5	15.2	19.6	24.0	28.3						
32	6.04	11.3	16.2	21.0	25.7	30.3						
35	6.66	12.4	17.9	23.2	28.3							
40	7.69	14.4	20.7	26.8								

- Note 1. kW ratings when using a one-pitch offset link (OL) are 80% of the above values.
- 2. The kW ratings of double strand Lambda Chain include a multi-strand coefficient factor of 1.4.
- 3. X-Lambda Chain uses the kW ratings shown here.
- 4. The kW ratings table for RS Roller Chain differs from the above.
- 5. Select KF Series Lambda Chain by kW rating with temperature selection from the operating temperature included.

Before Use
 Standard Roller Chains
 Lube-Free Roller Chains
 Heavy Duty Roller Chains
 Corrosion Resistant Roller Chains
 Specialty Roller Chains
 Sprockets
 Pin Gear Drives
 Accessories
 Selection
 Handling

Heavy Duty Lambda Chain

Before Use
 Standard Roller Chains
 Lube-Free Roller Chains
 Heavy Duty Roller Chains
 Corrosion Resistant Roller Chains
 Specialty Roller Chains
 Sprockets
 Accessories
 Selection
 Handling

Double strand

CL

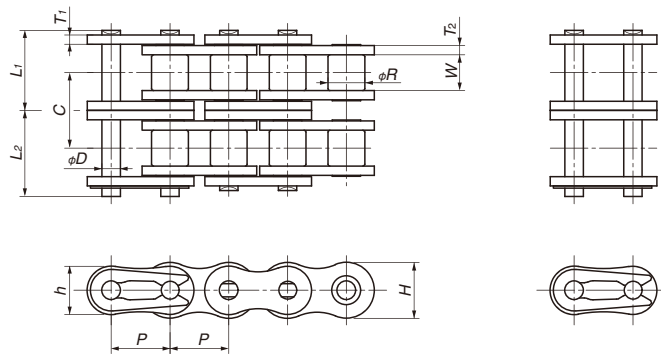

RS80 and larger chains use cotter pins for the connecting link.
 RS100 uses cotter pins for both the base chain and connecting links.

TSUBAKI Chain Number	Pitch P	Roller Diameter R	Inner Width of Inner Link W	Plates				Pins			Transverse Pitch C
				Thickness T_1	Thickness T_2	Height H	Height h	Diameter D	L_1	L_2	
RS40-LMD-H-2	12.70	7.92	7.55	2.0	2.0	12.0	10.4	3.97	17.5	19.15	16.4
RS50-LMD-H-2	15.875	10.16	9.26	2.4	2.4	15.0	13.0	5.09	20.95	22.65	19.7
RS60-LMD-H-2	19.05	11.91	12.28	3.2	3.2	18.1	15.6	5.96	27.55	29.45	26.1
RS80-LMD-H-2	25.40	15.88	15.48	4.0	4.0	24.1	20.8	7.94	34.6	37.2	32.6
RS100-LMD-H-2	31.75	19.05	18.70	4.8	4.8	30.1	26.0	9.54	41.4	44.1	39.1

TSUBAKI Chain Number	Minimum Tensile Strength kN{kgf}	Approximate Mass kg/m	Number of Links Per Unit	Allowable Speed m/min
RS40-LMD-H-2	35.3 {3600}	1.57	240	150
RS50-LMD-H-2	56.9 {5800}	2.35	192	135
RS60-LMD-H-2	80.4 {8200}	3.59	160	120
RS80-LMD-H-2	143 {14600}	6.18	120	90
RS100-LMD-H-2	214 {21800}	9.03	96	80

Note: The dimensions shown in this catalog are nominal dimensions and differ from actual dimensions.

Operating temperature range : -10°C to 150°C

Made-to-order item.

Sprocket

■ The transverse pitch (C) differs from standard RS Roller Chain. Double strand RS sprockets cannot be used – made-to-order sprockets are required.

Kilowatt ratings (Multi-strand coefficient)

- The multiple-strand coefficient of Heavy Duty Lambda Chains is 1.7. To select a chain, multiply the kW ratings on pgs. 65 and 66 by 1.7.
- Use a heavy duty press fit connecting link (FCL). Be aware that using a slip fit connecting link (MCL) will cause a decrease in the kW ratings.

Offset link

■ One pitch offset links (OL) are available but will have 60% the kW ratings.

Pin length

■ Because the outer and inner plates are thicker than RS Roller Chain's outer and inner plates, the pins are longer by an equal amount (L_1 and L_2). Check for machine interference.

Heavy Duty Lambda Chain NP Series

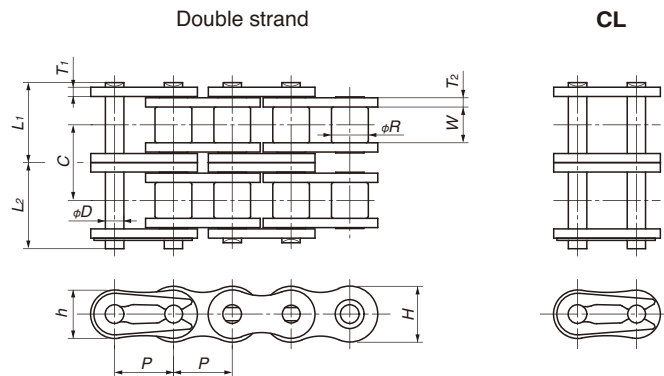

RS80 and larger chains use cotter pins for the connecting link.
RS100 uses cotter pins for both the base chain and connecting links.

TSUBAKI Chain Number	Pitch P	Roller Diameter R	Inner Width of Inner Link W	Plates				Pins			Transverse Pitch C
				Thickness T_1	Thickness T_2	Height H	Height h	Diameter D	L_1	L_2	
RS40-LMD-H-NP-2	12.70	7.92	7.55	2.0	2.0	12.0	10.4	3.97	17.5	19.15	16.4
RS50-LMD-H-NP-2	15.875	10.16	9.26	2.4	2.4	15.0	13.0	5.09	20.95	22.65	19.7
RS60-LMD-H-NP-2	19.05	11.91	12.28	3.2	3.2	18.1	15.6	5.96	27.55	29.45	26.1
RS80-LMD-H-NP-2	25.40	15.88	15.48	4.0	4.0	24.1	20.8	7.94	34.6	37.2	32.6
RS100-LMD-H-NP-2	31.75	19.05	18.70	4.8	4.8	30.1	26.0	9.54	41.4	44.1	39.1

TSUBAKI Chain Number	Minimum Tensile Strength kN{kgf}	Approximate Mass kg/m	Number of Links Per Unit	Allowable Speed m/min
RS40-LMD-H-NP-2	35.3 {3600}	1.57	240	150
RS50-LMD-H-NP-2	56.9 {5800}	2.35	192	135
RS60-LMD-H-NP-2	80.4 {8200}	3.59	160	120
RS80-LMD-H-NP-2	143 {14600}	6.18	120	90
RS100-LMD-H-NP-2	214 {21800}	9.03	96	80

Note: The dimensions shown in this catalog are nominal dimensions and differ from actual dimensions.

Operating temperature range : -10°C to 150°C

Made-to-order item.

Sprocket

- The transverse pitch (C) differs from standard RS Roller Chain. Double strand RS sprockets cannot be used – made-to-order sprockets are required.

Kilowatt ratings (Multi-strand coefficient)

- The multiple-strand coefficient of Heavy Duty Lambda Chains is 1.7. To select a chain, multiply the kW ratings on pgs. 61 and 62 by 1.7.
- Use a heavy duty press fit connecting link (FCL). Be aware that using a slip fit connecting link (MCL) will cause a decrease in the kW ratings.

Offset link

- One pitch offset links (OL) are available but will have 60% the kW ratings.

Pin length

- Because the outer and inner plates are thicker than RS Roller Chain's outer and inner plates, the pins are longer by an equal amount (L_1 and L_2). Check for machine interference.

Curved Lambda Chain

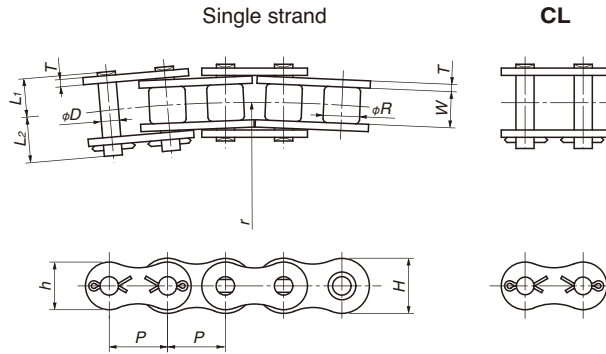

TSUBAKI Chain Number	Pitch P	Roller Diameter R	Inner Width of Inner Link W	Plates			Pins			
				Thickness T	Height H	Height h	Diameter D	$L_1 + L_2$	L_1	L_2
RS40-LMC-CU-1	12.70	7.92	7.95	1.5	12.0	10.4	3.59	18.2	8.45	9.75
RS50-LMC-CU-1	15.875	10.16	9.53	2.0	15.0	13.0	4.45	22.0	10.3	11.7
RS60-LMC-CU-1	19.05	11.91	12.70	2.4	18.1	15.6	5.35	27.5	12.95	14.55

TSUBAKI Chain Number	Minimum Tensile Strength kN{kgf}	Maximum Allowable Load kN{kgf}	Approximate Mass kg/m	Number of Links Per Unit	Minimum Horizontal Bending Radius r
RS40-LMC-CU-1	11.1 {1130}	1.86 {190}	0.61	240	400
RS50-LMC-CU-1	17.3 {1760}	2.84 {290}	1.01	192	500
RS60-LMC-CU-1	25.1 {2560}	4.02 {410}	1.40	160	600

Note: The dimensions shown in this catalog are nominal dimensions and differ from actual dimensions.

Operating temperature range : -10 to 150°C

Made-to-order item.

Sprocket : Can use RS Sprockets.

- Attachment chains are available.
- See 4.6 on pg. 204 for installation.

BS Lambda Chain (ISO606 B Series)

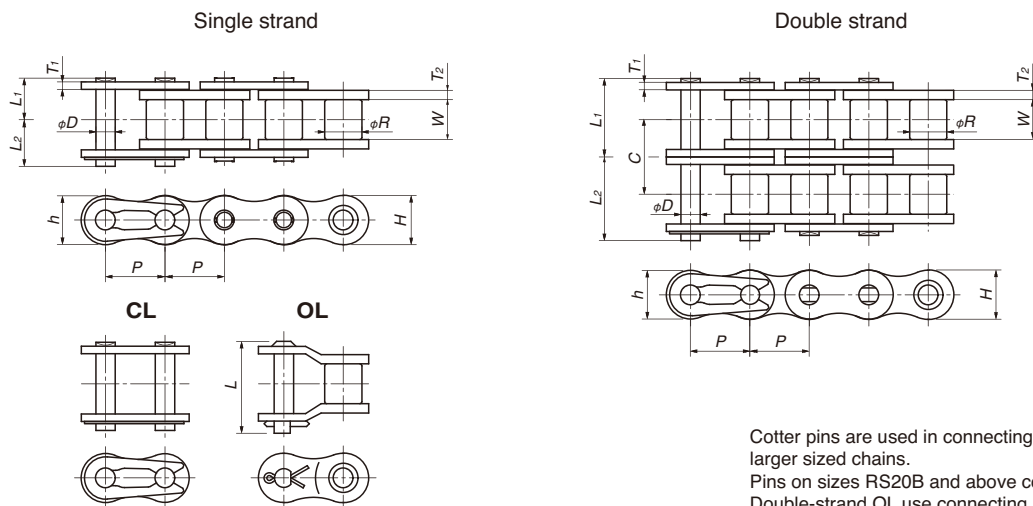

Cotter pins are used in connecting links for RS20B and larger sized chains.
 Pins on sizes RS20B and above come with a washer.
 Double-strand OL use connecting pins on both ends.

TSUBAKI Chain Number		JIS No.	Pitch P	Roller Diameter R	Inner Width of Inner Link W	Plates				Pins		
Single-strand	Double-strand					Thickness T1	Thickness T2	Height H	Height h	Diameter D	L 1 2-strand value in ()	L 2 2-strand value in ()
RF06B-LM-1	RF06B-LM-2	06B	9.525	6.35	5.72	1.0	1.3	8.2	8.2	3.28	6.1 (11.2)	7.7 (12.8)
RS08B-LM-1	RS08B-LM-2	08B	12.70	8.51	7.75	1.6	1.6	11.8	10.4	4.45	8.4 (15.3)	10.0 (16.9)
RS10B-LM-1	RS10B-LM-2	10B	15.875	10.16	9.65	1.5	1.5	14.7	13.7	5.08	9.55 (17.85)	11.25 (19.55)
RS12B-LM-1	RS12B-LM-2	12B	19.05	12.07	11.68	1.8	1.8	16.1	16.1	5.72	11.1 (20.85)	13.0 (22.75)
RS16B-LM-1	RS16B-LM-2	16B	25.40	15.88	17.02	3.2	4.0	21.0	21.0	8.28	17.75 (33.55)	19.95 (35.75)
RS20B-LM-1	RS20B-LM-2	20B	31.75	19.05	19.56	3.4	4.4	26.4	26.0	10.19	19.9 (38.25)	23.1 (41.45)
RS24B-LM-1	RS24B-LM-2	24B	38.10	25.40	25.40	5.6	6.0	33.4	31.2	14.63	26.65 (50.8)	31.85 (56.0)

TSUBAKI Chain Number		Offset Pin Length L 2-strand value in ()	Minimum Tensile Strength kN{kgf}		Approximate Mass kg/m 2-strand value in ()	Number of Links Per Unit	Allowable Speed (m/min)	Transverse Pitch C
Single-strand	Double-strand		Single-strand	Double-strand				
RF06B-LM-1	RF06B-LM-2	15.1 (25.9)	8.90 {910}	16.9 {1720}	0.39 (0.75)	320	160	10.24
RS08B-LM-1	RS08B-LM-2	18.6 (34.5)	17.8 {1820}	31.1 {3170}	0.70 (1.35)	240	150	13.92
RS10B-LM-1	RS10B-LM-2	20.8 (39.4)	22.2 {2260}	44.5 {4540}	0.95 (1.85)	192	135	16.59
RS12B-LM-1	RS12B-LM-2	24.4 (45.9)	28.9 {2950}	57.8 {5890}	1.25 (2.50)	160	120	19.46
RS16B-LM-1	RS16B-LM-2	41.1 (75.2)	60.0 {6120}	106 {10800}	2.70 (5.40)	120	90	31.88
RS20B-LM-1	RS20B-LM-2	46.6 (84.6)	95.0 {9690}	170 {17300}	3.85 (7.65)	96	80	36.45
RS24B-LM-1	RS24B-LM-2	61.7 (112.8)	160 {16300}	280 {28600}	7.45 (14.65)	80	50	48.36

- Note 1. RF06B plate is flat:
- Multi-strand RF06B and RS08B chains have one middle plate.
 - Minimum tensile strength of attachment chains differs from those above. Contact a Tsubaki representative for details.
 - Items in bold are stocked in units. All other items are made-to-order.
 - The dimensions shown in this catalog are nominal dimensions and differ from actual dimensions.

Operating temperature range : -10 to 150°C

Sprocket

■ Use BS Roller chain (ISO-compliant B Series) sprockets.

Easy cutting / connection

■ Cutting and connecting is easy with a special tool due to a newly developed pin and new riveting style.
 (On single-strand chains from RS08B to RS16B.)

Interchangeability

- Single strand BS Lambda Chain is dimensionally interchangeable with BS/DIN RS Roller Chain; however, be aware that the kW ratings and allowable speed differ.
- Replace the entire chain when replacing previous Lambda specifications with the model upgrade of June 2012.
- Do not connect previous Lambda specifications with new specifications, and do not use connecting links, offset links, and other connecting parts from the previous specifications with the new specifications.

Kilowatt Ratings Tables (BS Lambda Chain [ISO 606 B Series])

Before Use
 Standard Roller Chains
 Lube-Free Roller Chains
 Heavy Duty Roller Chains
 Corrosion Resistant Roller Chains
 Specialty Roller Chains
 Sprockets
 Pin Gear Drives
 Accessories
 Selection
 Handling

RF06B-LM-1 Maximum Kilowatt Ratings Table (kW Ratings for Single Strand Chain)

Small sprocket number of teeth	Small Sprocket Max rpm								
	50	100	300	500	700	900	1200	1500	1800
9	0.06	0.11	0.31	0.49	0.66	0.83	1.07	1.31	1.55
10	0.07	0.13	0.35	0.55	0.74	0.93	1.20	1.47	
11	0.08	0.14	0.38	0.61	0.82	1.03	1.33	1.63	
12	0.08	0.16	0.42	0.67	0.90	1.13	1.47		
13	0.09	0.17	0.46	0.73	0.98	1.23	1.60		
14	0.10	0.18	0.50	0.79	1.07	1.34			
15	0.11	0.20	0.54	0.85	1.15	1.44			
16	0.11	0.21	0.57	0.91	1.23	1.54			
17	0.12	0.23	0.61	0.97	1.31	1.65			
18	0.13	0.24	0.65	1.03	1.40	1.75			
19	0.14	0.26	0.69	1.09	1.48				
20	0.15	0.27	0.73	1.16	1.57				
21	0.15	0.29	0.77	1.22	1.65				
22	0.16	0.30	0.81	1.28	1.74				
23	0.17	0.32	0.85	1.35	1.82				
24	0.18	0.33	0.89	1.41					
25	0.19	0.35	0.93	1.47					
26	0.19	0.36	0.97	1.54					

RS08B-LM-1 Maximum Kilowatt Ratings Table (kW Ratings for Single Strand Chain)

Small sprocket number of teeth	Small Sprocket Max rpm											
	10	25	50	100	200	300	400	500	700	900	1000	1200
9	0.05	0.11	0.20	0.38	0.71	1.02	1.32	1.62	2.19	2.75	3.02	3.56
10	0.05	0.12	0.23	0.43	0.80	1.15	1.48	1.81	2.46	3.08	3.39	
11	0.06	0.14	0.25	0.47	0.88	1.27	1.65	2.01	2.72	3.41	3.75	
12	0.07	0.15	0.28	0.52	0.97	1.40	1.81	2.21	2.99	3.75		
13	0.07	0.16	0.30	0.57	1.06	1.52	1.97	2.41	3.26	4.09		
14	0.08	0.18	0.33	0.61	1.14	1.65	2.13	2.61	3.53			
15	0.08	0.19	0.35	0.66	1.23	1.78	2.30	2.81	3.81			
16	0.09	0.20	0.38	0.71	1.32	1.90	2.47	3.01	4.08			
17	0.10	0.22	0.41	0.76	1.41	2.03	2.63	3.22				
18	0.10	0.23	0.43	0.80	1.50	2.16	2.80	3.42				
19	0.11	0.24	0.46	0.85	1.59	2.29	2.97	3.63				
20	0.11	0.26	0.48	0.90	1.68	2.42	3.14	3.84				
21	0.12	0.27	0.51	0.95	1.77	2.55	3.31	4.04				
22	0.13	0.29	0.54	1.00	1.86	2.68	3.48	4.25				
23	0.13	0.30	0.56	1.05	1.96	2.82	3.65	4.46				
24	0.14	0.32	0.59	1.10	2.05	2.95	3.82					
25	0.14	0.33	0.61	1.15	2.14	3.08	3.99					
26	0.15	0.34	0.64	1.20	2.23	3.22	4.17					

RS10B-LM-1 Maximum Kilowatt Ratings Table (kW Ratings for Single Strand Chain)

Small sprocket number of teeth	Small Sprocket Max rpm									
	10	25	50	100	200	300	400	500	700	900
9	0.07	0.16	0.30	0.55	1.03	1.48	1.92	2.35	3.18	3.99
10	0.08	0.18	0.33	0.62	1.15	1.66	2.15	2.63	3.56	
11	0.09	0.20	0.37	0.69	1.28	1.84	2.39	2.92	3.95	
12	0.09	0.22	0.40	0.75	1.41	2.02	2.62	3.21	4.34	
13	0.10	0.24	0.44	0.82	1.53	2.21	2.86	3.50		
14	0.11	0.26	0.48	0.89	1.66	2.39	3.10	3.79		
15	0.12	0.28	0.51	0.96	1.79	2.58	3.34	4.08		
16	0.13	0.30	0.55	1.03	1.92	2.76	3.58	4.38		
17	0.14	0.32	0.59	1.10	2.05	2.95	3.82	4.67		
18	0.15	0.34	0.63	1.17	2.18	3.14	4.06			
19	0.16	0.36	0.66	1.24	2.31	3.33	4.31			
20	0.16	0.38	0.70	1.31	2.44	3.52	4.55			
21	0.17	0.40	0.74	1.38	2.57	3.71	4.80			
22	0.18	0.42	0.78	1.45	2.71	3.90				
23	0.19	0.44	0.82	1.52	2.84	4.09				
24	0.20	0.46	0.85	1.59	2.97	4.28				
25	0.21	0.48	0.89	1.66	3.11	4.47				
26	0.22	0.50	0.93	1.74	3.24	4.67				

RS12B-LM-1 Maximum Kilowatt Ratings Table (kW Ratings for Single Strand Chain)

Small sprocket number of teeth	Small Sprocket Max rpm										
	10	25	50	100	150	200	300	400	500	600	700
9	0.10	0.23	0.42	0.79	1.13	1.47	2.11	2.74	3.35	3.95	4.53
10	0.11	0.25	0.47	0.88	1.27	1.64	2.37	3.07	3.75	4.42	
11	0.12	0.28	0.52	0.98	1.41	1.82	2.63	3.40	4.16		
12	0.14	0.31	0.58	1.07	1.55	2.00	2.89	3.74	4.57		
13	0.15	0.34	0.63	1.17	1.69	2.18	3.15	4.08			
14	0.16	0.36	0.68	1.27	1.83	2.37	3.41	4.41			
15	0.17	0.39	0.73	1.37	1.97	2.55	3.67	4.76			
16	0.18	0.42	0.78	1.46	2.11	2.73	3.94				
17	0.20	0.45	0.84	1.56	2.25	2.92	4.20				
18	0.21	0.48	0.89	1.66	2.40	3.10	4.47				
19	0.22	0.51	0.94	1.76	2.54	3.29	4.74				
20	0.23	0.54	1.00	1.86	2.68	3.48	5.01				
21	0.25	0.56	1.05	1.96	2.83	3.67					
22	0.26	0.59	1.11	2.07	2.98	3.85					
23	0.27	0.62	1.16	2.17	3.12	4.04					
24	0.29	0.65	1.22	2.27	3.27	4.23					
25	0.30	0.68	1.27	2.37	3.42	4.43					
26	0.31	0.71	1.33	2.47	3.56	4.62					

- Note 1. KW ratings when using a one-pitch offset link (OL) are 80% that of the above values.
 2. Kilowatt ratings tables for BS Roller Chains differ from the above.
 3. The kW ratings of double strand Lambda Chain include a multi-strand coefficient factor of 1.7.

Kilowatt Ratings Tables (BS Lambda Chain [ISO 606 B Series])

■RS16B-LM-1 Maximum Kilowatt Ratings Table (kW Ratings for Single Strand Chain)

Small sprocket number of teeth	Small Sprocket Max rpm							
	10	25	50	100	150	200	300	350
9	0.32	0.73	1.36	2.54	3.65	4.73	6.82	7.83
10	0.36	0.82	1.52	2.84	4.09	5.30	7.64	8.78
11	0.40	0.90	1.69	3.15	4.54	5.88	8.47	
12	0.44	0.99	1.85	3.46	4.98	6.46		
13	0.47	1.08	2.02	3.77	5.43	7.04		
14	0.51	1.17	2.19	4.09	5.89	7.63		
15	0.55	1.26	2.36	4.40	6.34	8.22		
16	0.59	1.36	2.53	4.72	6.80	8.81		
17	0.63	1.45	2.70	5.04	7.26	9.41		
18	0.68	1.54	2.87	5.36	7.72			
19	0.72	1.63	3.05	5.68	8.19			
20	0.76	1.73	3.22	6.01	8.65			
21	0.80	1.82	3.39	6.33	9.12			
22	0.84	1.91	3.57	6.66	9.59			
23	0.88	2.01	3.74	6.99	10.1			
24	0.92	2.10	3.92	7.32				
25	0.96	2.20	4.10	7.65				
26	1.00	2.29	4.27	7.98				

■RS20B-LM-1 Maximum Kilowatt Ratings Table (kW Ratings for Single Strand Chain)

Small sprocket number of teeth	Small Sprocket Max rpm							
	10	25	50	100	150	200	275	
9	0.54	1.23	2.30	4.30	6.19	8.02	10.7	
10	0.61	1.38	2.58	4.82	6.94	8.99		
11	0.67	1.53	2.86	5.34	7.69	9.96		
12	0.74	1.68	3.14	5.87	8.45	10.9		
13	0.81	1.84	3.43	6.39	9.21			
14	0.87	1.99	3.71	6.93	9.98			
15	0.94	2.14	4.00	7.46	10.8			
16	1.01	2.30	4.29	8.00	11.5			
17	1.08	2.45	4.58	8.54				
18	1.14	2.61	4.87	9.09				
19	1.21	2.77	5.16	9.63				
20	1.28	2.92	5.46	10.2				
21	1.35	3.08	5.75	10.7				
22	1.42	3.24	6.05	11.3				
23	1.49	3.40	6.35	11.8				
24	1.56	3.56	6.64	12.4				
25	1.63	3.72	6.94	13.0				
26	1.70	3.88	7.24					

■RS24B-LM-1 Maximum Kilowatt Ratings Table (kW Ratings for Single Strand Chain)

Small sprocket number of teeth	Small Sprocket Max rpm				
	10	25	50	100	125
9	0.97	2.20	4.11	7.67	9.38
10	1.08	2.47	4.61	8.60	10.5
11	1.20	2.74	5.11	9.53	
12	1.32	3.01	5.61	10.5	
13	1.44	3.28	6.12	11.4	
14	1.56	3.55	6.63		
15	1.68	3.83	7.14		
16	1.80	4.10	7.65		
17	1.92	4.38	8.17		
18	2.04	4.66	8.69		
19	2.17	4.94	9.22		
20	2.29	5.22	9.74		
21	2.41	5.50	10.3		
22	2.54	5.79	10.8		
23	2.66	6.07	11.3		
24	2.79	6.36	11.9		
25	2.91	6.64	12.4		
26	3.04	6.93	12.9		

- Note 1. KW ratings when using a one-pitch offset link (OL) are 80% that of the above values.
 2. Kilowatt ratings tables for BS Roller Chains differ from the above.
 3. The kW ratings of double strand Lambda Chain include a multi-strand coefficient factor of 1.7.

Heavy Duty Roller Chains

Tsubaki's Heavy Duty Roller Chains come in a wide array of products. Their high maximum allowable load make them commonly used in compact transmission systems.

Use Tsubaki Heavy Duty Roller Chains when capacity exceeds that of RS Roller Chains, such as in:

1. Harsh environments where the chain will be subjected to heavy impact.
2. Compact drives for equipment or machines that must work in tight spaces.
3. When higher transmission power, allowable load or tensile strength is required.
4. When a lower rate of elastic elongation is required.

Ex.: Construction equipment, agricultural equipment, port equipment, vertical parking structures, etc.

Comparison of min. tensile strengths and max. allowable loads

Note : With RS Roller Chain min. tensile strength and max. allowable load as benchmark (100).

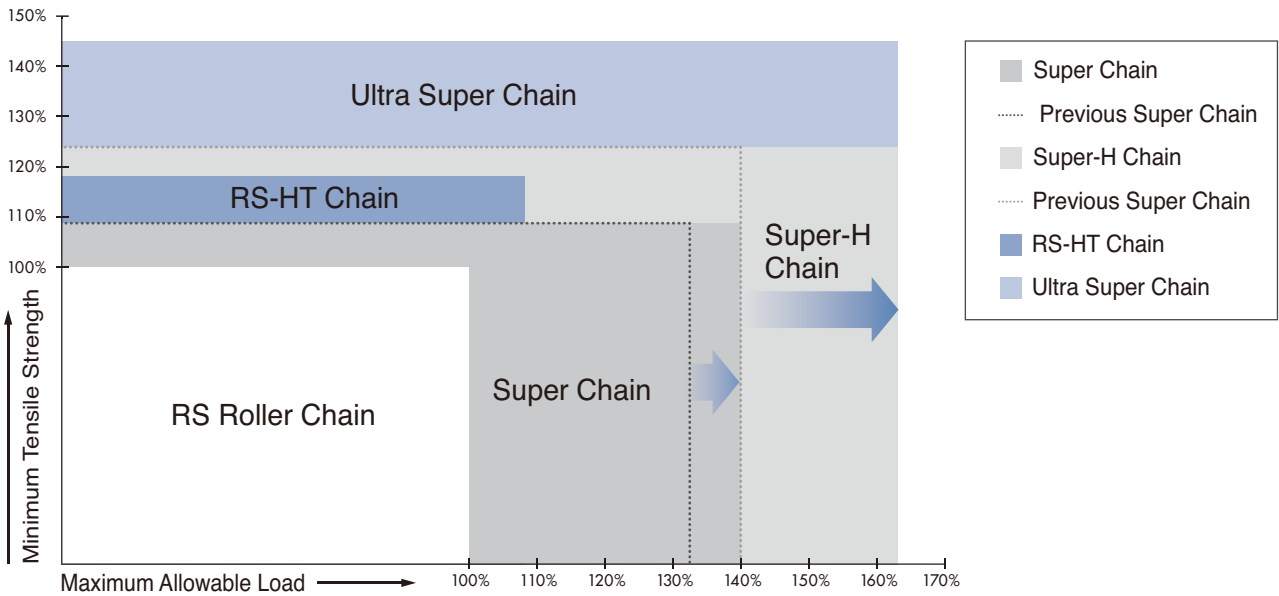

Features

Model Point	Super Chain	RS-HT Chain	Super-H Chain	Ultra Super Chain
Features	<ul style="list-style-type: none"> ● High kW ratings ● High shock absorption ● Users can go one size down from RS Roller Chain 	<ul style="list-style-type: none"> ● High kW ratings ● High tensile strength ● High shock absorption 	<ul style="list-style-type: none"> ● High fatigue strength ● High tensile strength ● High shock absorption ● Same maximum allowable load as double strand RS Roller Chain 	<ul style="list-style-type: none"> ● Has the highest fatigue strength, tensile strength, and shock absorption of all Tsubaki chains. Designed for compact drives. ● Users can go two sizes down from RS Roller Chain
Offset links	<ul style="list-style-type: none"> ● 4POL available for single strand chain only 	<ul style="list-style-type: none"> ● Offset links are not available. Use an even number of links. 		
Sprockets	<ul style="list-style-type: none"> ● Both single and multi-strand chains can use RS sprockets. 	<ul style="list-style-type: none"> ● Single strand chains can use RS sprockets ● Multi-strand RS-HT and Super-H chains cannot use RS sprockets. 		
	<ul style="list-style-type: none"> ● Small sprockets must have heat treated hardened teeth. ● Use sprockets made of S35C or higher carbon steel. ● Tsubaki offers TOUGH TOOTH sprockets optimized for use with Heavy Duty Drive Chain. See pgs. 103 – 105 of this catalog for more information. 			

Product Line-up

Super Chain

► Pg. 75

Super Chain has the same three basic dimensions of RS Roller Chain, but it has a thicker waist that provides a 40% increase in maximum allowable load over RS Roller Chain. Suitable for situations where RS Roller Chain would suffer fatigue breakage, and allows users to go one size down.

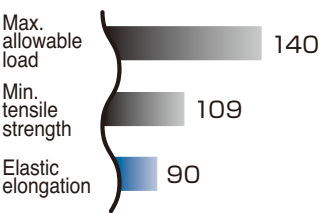

■ **Sprocket Number :**
 [Base chain]
RS80-SUP-1-M
 Super Chain | F: F-type connecting link
 M: M-type connecting link
 [Connecting links]
RS80-SUP-1-FCL
 FCL: F-type connecting link
 MCL: M-type connecting link

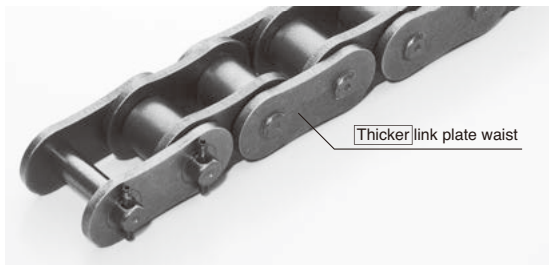

- **Connecting link with same strength as base chain**
 Connecting link with same strength as base chain
 Uses connecting links with ring coining, which allows for easy attachment and removal of the connecting link but provides the same strength as the base chain links.
- **Four pitch offset links (4POL)**
 Super Chain can even be used with an odd number links to create the perfect length for your needs. (4POL max. allowable load and kW ratings are 90% of the base chain. Only available for single strand chain.)

RS-HT Chain

► Pg. 78

The outer and inner plates are one size thicker than on RS Roller Chains. RS-HT Chain has 20% greater tensile strength than RS Roller Chain, and so is ideal for applications requiring high tensile strength and low elastic elongation.

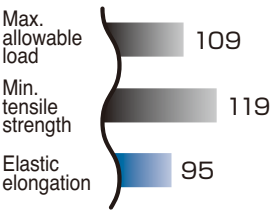

■ **Sprocket Number :**
 [Base chain]
RS80-HT-1-M
 RS-HT Chain | Blank: F-type connecting link
 M: M-type connecting link
 [Connecting links]
RS80-HT-1-FCL
 FCL: F-type connecting link
 MCL: M-type connecting link

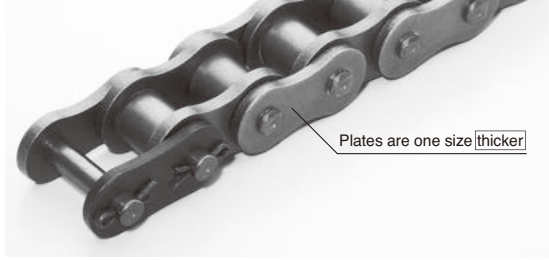

- **Connecting link with same strength as base chain**
 Connecting link with same strength as base chain
 Uses connecting links with ring coining, which allows for easy attachment and removal of the connecting link but provides the same strength as the base chain links.

Super-H Chain

► Pg. 81

Features inner and outer link plates shaped the same way as Super Chain that are one size thicker than RS Roller Chain. This gives Super-H Chains a higher allowable load and fatigue strength for applications requiring shock absorption.

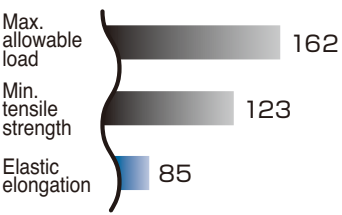

■ **Sprocket Number :**
 [Base chain]
RS80-SUP-H-1-F
 Super-H Chain
 [Connecting links]
RS80-SUP-H-1-FCL
 F-type connecting link

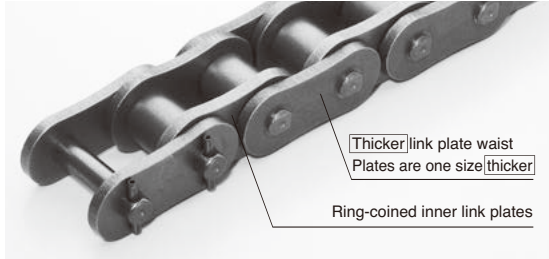

Ultra Super Chain

► Pg. 82

Inner and outer link plates are oval and one size thicker than RS Roller Chains. Ultra Super Chains have the highest allowable load, tensile strength, and shock absorption of any Tsubaki drive chain, and are suitable for drives requiring a compact design.

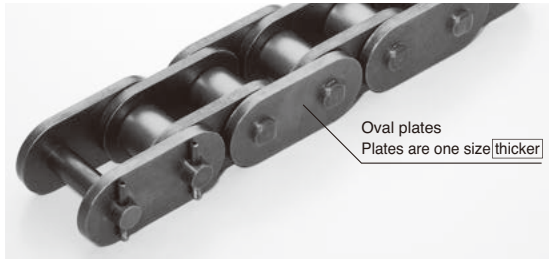
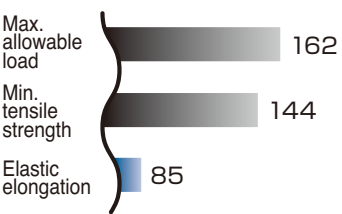

■ **Sprocket Number :** **RF100-US-N-1**
 Oval plates | Ultra Super Chain

*The values in each graph are shown in relation to standard roller chain with a benchmark of 100. (Comparison with RS100.)

Super Roller Chain

Before Use
Standard Roller Chains
Lube-Free Roller Chains

Heavy Duty Roller Chains
Corrosion Resistant Roller Chains
Specialty Roller Chains
Sprockets

Pin Gear Drives
Accessories

Selection

Handling

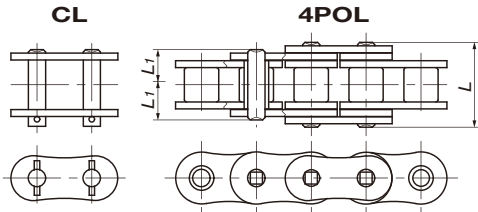
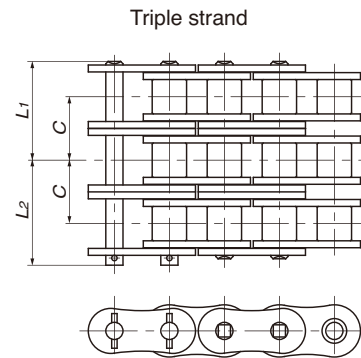
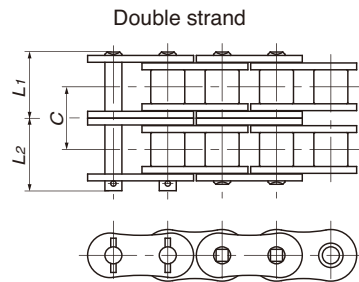
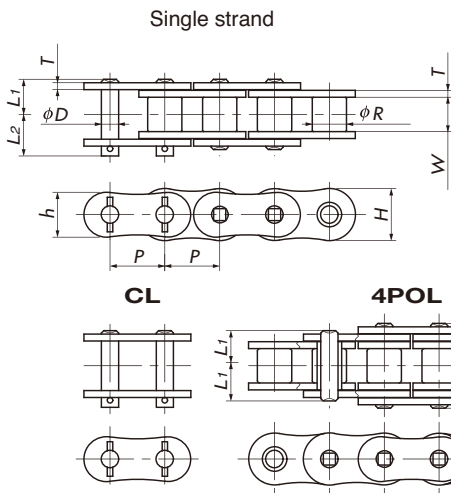

Connecting links
Slip fit M-type connecting links (MCL)
and press fit F-type connecting links (FCL) available.
(See pg.12)

TSUBAKI Chain Number	Pitch P	Roller Diameter R	Inner Width of Inner Link W	Plates			Pins D	4 pitch offset links Pin Length L
				Thickness T	Height H	Height h		
RS80-SUP-1 RS80-SUP-2 RS80-SUP-3	25.40	15.88	15.88	3.2	24.1	20.8	7.94	39.3
RS100-SUP-1 RS100-SUP-2 RS100-SUP-3	31.75	19.05	19.05	4.0	30.1	26.0	9.54	48.0
RS120-SUP-1 RS120-SUP-2 RS120-SUP-3	38.10	22.23	25.40	4.8	36.2	31.2	11.11	59.9
RS140-SUP-1 RS140-SUP-2 RS140-SUP-3	44.45	25.40	25.40	5.6	42.2	36.4	12.71	65.7
RS160-SUP-1 RS160-SUP-2 RS160-SUP-3	50.80	28.58	31.75	6.4	48.2	41.6	14.29	77.2
RS180-SUP-1 RS180-SUP-2 RS180-SUP-3	57.15	35.71	35.72	7.15	54.2	46.8	17.46	86.4
RS200-SUP-1 RS200-SUP-2 RS200-SUP-3	63.50	39.68	38.10	8.0	60.3	52.0	19.85	94.9
RS240-SUP-1 RS240-SUP-2 RS240-SUP-3	76.20	47.63	47.63	9.5	72.4	62.4	23.81	116.0

TSUBAKI Chain Number	Number of Strands	Pin Length L1+L2	Dimensions L1	Dimensions L2	Transverse Pitch C	Minimum Tensile Strength kN{kgf}	Average Tensile Strength kN{kgf}	Maximum Allowable Load kN{kgf}	Approximate Mass kg/m	Links Per Unit
RS80-SUP-1 RS80-SUP-2 RS80-SUP-3	1 2 3	35.5 64.8 94.1	16.25 30.9 45.6	19.25 33.9 48.5	29.3	74.2 { 7570 } 148 { 15140 } 223 { 22710 }	85.3 { 8700 } 171 { 17400 } 256 { 26100 }	20.1 { 2050 } 34.2 { 3490 } 50.3 { 5130 }	2.81 5.62 8.40	120
RS100-SUP-1 RS100-SUP-2 RS100-SUP-3	1 2 3	42.6 78.5 114.4	19.75 37.7 55.65	22.85 40.8 58.75	35.8	111 { 11300 } 222 { 22600 } 332 { 33900 }	127 { 13000 } 255 { 26000 } 382 { 39000 }	32.4 { 3300 } 55.0 { 5610 } 80.9 { 8250 }	4.25 8.38 12.57	96
RS120-SUP-1 RS120-SUP-2 RS120-SUP-3	1 2 3	53.8 99.2 144.8	24.9 47.6 70.4	28.9 51.6 74.4	45.4	162 { 16500 } 324 { 33000 } 485 { 49500 }	186 { 19000 } 373 { 38000 } 559 { 57000 }	42.2 { 4300 } 71.7 { 7310 } 105 { 10750 }	6.3 12.44 18.64	80
RS140-SUP-1 RS140-SUP-2 RS140-SUP-3	1 2 3	58.6 107.5 156.6	26.9 51.35 75.85	31.7 56.15 80.75	48.9	213 { 21700 } 426 { 43400 } 638 { 65100 }	245 { 25000 } 490 { 50000 } 735 { 75000 }	56.9 { 5800 } 96.7 { 9860 } 142 { 14500 }	8.04 15.92 23.84	68
RS160-SUP-1 RS160-SUP-2 RS160-SUP-3	1 2 3	68.7 127.3 185.9	31.85 61.15 90.45	36.85 66.15 95.45	58.5	273 { 27800 } 545 { 55600 } 818 { 83400 }	314 { 32000 } 628 { 64000 } 941 { 96000 }	73.5 { 7500 } 125 { 12750 } 184 { 18750 }	10.79 21.43 32.10	60
RS180-SUP-1 RS180-SUP-2 RS180-SUP-3	1 2 3	78.1 144.1 210.2	35.65 68.75 101.7	42.45 75.35 108.5	65.8	358 { 36500 } 716 { 73000 } 1070 { 109500 }	412 { 42000 } 824 { 84000 } 1240 { 126000 }	85.7 { 8740 } 146 { 14860 } 214 { 21850 }	14.23 28.08 40.56	54
RS200-SUP-1 RS200-SUP-2 RS200-SUP-3	1 2 3	83.8 155.5 227.2	39.0 74.85 110.75	44.8 80.65 116.45	71.6	439 { 44800 } 879 { 89600 } 1320 { 134400 }	505 { 51500 } 1010 { 103000 } 1520 { 154500 }	100 { 10200 } 170 { 17340 } 250 { 25500 }	17.63 34.91 52.44	48
RS240-SUP-1 RS240-SUP-2 RS240-SUP-3	1 2 3	103.4 191.3 279.0	47.9 91.9 135.85	55.5 99.4 143.15	87.8	639 { 65200 } 1280 { 130400 } 1920 { 195600 }	735 { 75000 } 1470 { 150000 } 2210 { 225000 }	139 { 14200 } 237 { 24140 } 348 { 35500 }	25.63 50.88 76.11	40

- Note 1. Pins are riveted.
- The dimensions shown in this catalog are nominal dimensions and differ from actual dimensions.
- Four-pitch offset links (4POL) available for single strand only.
- Maximum allowable load when using a four-pitch offset link (4POL) is 85% that of the above values.
- Items in bold are stocked in units. All other items are made-to-order.
- Can use RS sprockets. Use sprockets made of S35C or higher steel. Sprockets with small numbers of teeth need to have their teeth hardened. Check the keyway strength.
- Tsubaki offers TOUGH TOOTH sprockets (pgs. 103 – 105) with increased hub strength.

Kilowatt Ratings Tables (RS80-SUP~RS140-SUP)

RS80-SUP-1 Maximum Kilowatt Ratings Table
(kW Ratings for Single Strand Chain)

Lubrication Type Small Sprocket No. of Teeth	Small Sprocket Max rpm											
	10	25	50	100	150	200	300	400	500	600	700	800
	A II			B			C					
13	1.08	2.46	4.59	8.57	12.3	16.0	23.0	29.8	32.1	32.1	32.1	
14	1.17	2.67	4.97	9.28	13.4	17.3	25.0	32.3	35.9	35.9	35.9	
15	1.26	2.87	5.36	10.0	14.4	18.7	26.9	34.8	39.8	39.8	39.8	
16	1.35	3.08	5.75	10.7	15.4	20.0	28.8	37.3	43.8	43.8	43.8	
17	1.44	3.29	6.14	11.4	16.5	21.4	30.8	39.9	48.0	48.0	48.0	
18	1.53	3.50	6.53	12.2	17.5	22.7	32.7	42.4	51.4	51.4	51.4	
19	1.62	3.71	6.92	12.9	18.6	24.1	34.7	45.0	54.4	54.4	54.4	
20	1.70	3.92	7.31	13.6	19.7	25.5	36.7	47.5	57.5	57.5	57.5	
21	1.79	4.13	7.71	14.4	20.7	26.8	38.7	50.1	60.7	60.7	60.7	
22	1.87	4.34	8.11	15.1	21.8	28.2	40.7	52.7	63.8	63.8	63.8	
23	1.96	4.56	8.50	15.9	22.9	29.6	42.7	55.3	66.9	66.9	66.9	
24	2.04	4.77	8.90	16.6	23.9	31.0	44.7	57.9	70.1	70.1	70.1	
25	2.13	4.99	9.31	17.4	25.0	32.4	46.7	60.5	73.2	73.2	73.2	
26	2.21	5.20	9.71	18.1	26.1	33.8	48.7	63.1	76.4	76.4	76.4	
28	2.38	5.64	10.5	19.6	28.3	36.6	52.7	68.3	83.0	83.0	83.0	83.0
30	2.55	6.07	11.3	21.1	30.5	39.5	56.8	73.6	90.0	92.1	92.1	92.1
32	2.72	6.51	12.1	22.7	32.7	42.3	60.9	78.9	96.5	101	101	101
35	2.98	7.17	13.4	25.0	36.0	46.6	67.1	87.0	106	116	116	116
40	3.40	8.28	15.5	28.8	41.6	53.8	77.5	101	123	137	137	137
45	3.83	9.41	17.6	32.8	47.2	61.1	88.1	114	139	156	156	156

RS100-SUP-1 Maximum Kilowatt Ratings Table
(kW Ratings for Single Strand Chain)

Lubrication Type Small Sprocket No. of Teeth	Small Sprocket Max rpm										
	10	25	50	100	150	200	300	400	500	600	700
	A II			B		C					
13	2.17	4.96	9.25	17.3	24.9	32.2	46.4	48.9	48.9		
14	2.35	5.37	10.0	18.7	26.9	34.9	50.3	54.0	54.0	54.0	
15	2.54	5.79	10.8	20.2	29.0	37.6	54.2	59.9	59.9	59.9	
16	2.72	6.20	11.6	21.6	31.1	40.3	58.1	66.0	66.0	66.0	
17	2.90	6.62	12.4	23.1	33.2	43.0	62.0	72.3	72.3	72.3	
18	3.09	7.05	13.1	24.5	35.3	45.8	66.0	78.8	78.8	78.8	
19	3.26	7.47	13.9	26.0	37.5	48.5	69.9	85.4	85.4	85.4	
20	3.43	7.90	14.7	27.5	39.6	51.3	73.9	91.8	91.8	91.8	
21	3.60	8.32	15.5	29.0	41.7	54.1	77.9	96.8	96.8	96.8	
22	3.77	8.75	16.3	30.5	43.9	56.9	81.9	102	102	102	
23	3.94	9.18	17.1	32.0	46.1	59.7	85.9	107	107	107	
24	4.11	9.61	17.9	33.5	48.2	62.5	90.0	112	112	112	
25	4.29	10.1	18.7	35.0	50.4	65.3	94.0	117	117	117	
26	4.46	10.5	19.6	36.5	52.6	68.1	98.1	122	122	122	
28	4.80	11.4	21.2	39.5	57.0	73.8	106	132	132	132	
30	5.14	12.2	22.8	42.6	61.4	79.5	115	142	142	142	
32	5.49	13.1	24.5	45.7	65.8	85.2	123	153	153	153	
35	6.00	14.5	27.0	50.3	72.5	93.9	135	170	170	170	170
40	6.86	16.7	31.1	58.1	83.7	108	156	202	207	207	207
45	7.72	19.0	35.4	66.0	95.1	123	177	230	247	247	247

RS120-SUP-1 Maximum Kilowatt Ratings Table
(kW Ratings for Single Strand Chain)

Lubrication Type Small Sprocket No. of Teeth	Small Sprocket Max rpm									
	10	25	50	100	150	200	300	400	500	600
	A II		B		C					
13	3.40	7.75	14.5	27.0	38.9	50.4	72.5	73.5	73.5	
14	3.68	8.40	15.7	29.2	42.1	54.6	78.6	82.2	82.2	
15	3.97	9.05	16.9	31.5	45.4	58.8	84.7	91.2	91.2	
16	4.25	9.70	18.1	33.8	48.6	63.0	90.8	100	100	
17	4.54	10.4	19.3	36.1	51.9	67.3	96.9	110	110	
18	4.82	11.0	20.6	38.4	55.2	71.6	103	118	118	
19	5.09	11.7	21.8	40.7	58.6	75.9	109	125	125	
20	5.36	12.3	23.0	43.0	61.9	80.2	116	132	132	
21	5.63	13.0	24.3	45.3	65.2	84.5	122	139	139	
22	5.90	13.7	25.5	47.6	68.6	88.9	128	146	146	
23	6.16	14.4	26.8	50.0	72.0	93.3	134	153	153	
24	6.43	15.0	28.0	52.3	75.4	97.6	141	160	160	
25	6.70	15.7	29.3	54.7	78.8	102	147	168	168	
26	6.97	16.4	30.6	57.1	82.2	107	153	175	175	
28	7.50	17.7	33.1	61.8	89.0	115	166	190	190	
30	8.04	19.1	35.7	66.6	95.9	124	179	204	204	
32	8.58	20.5	38.3	71.4	103	133	192	219	219	
35	9.38	22.6	42.1	78.6	113	147	211	247	247	247
40	10.7	26.1	48.7	90.8	131	170	244	302	302	302
45	12.1	29.6	55.3	103	149	193	277	359	360	360

RS140-SUP-1 Maximum Kilowatt Ratings Table
(kW Ratings for Single Strand Chain)

Lubrication Type Small Sprocket No. of Teeth	Small Sprocket Max rpm													
	10	25	50	100	150	200	250	300	350	400	450	500	550	
	A II		B		C									
13	5.34	12.2	22.7	42.5	61.1	79.2	96.8	96.8	96.8	96.8				
14	5.79	13.2	24.6	46.0	66.2	85.8	105	109	109	109	109			
15	6.24	14.2	26.6	49.5	71.4	92.5	113	121	121	121	121			
16	6.69	15.3	28.5	53.1	76.5	99.1	121	133	133	133	133			
17	7.14	16.3	30.4	56.7	81.7	106	129	144	144	144	144			
18	7.59	17.3	32.3	60.3	86.9	113	138	153	153	153	153			
19	8.01	18.4	34.3	64.0	92.1	119	146	162	162	162	162			
20	8.43	19.4	36.2	67.6	97.4	126	154	171	171	171	171			
21	8.85	20.5	38.2	71.3	103	133	163	181	181	181	181			
22	9.27	21.5	40.2	74.9	108	140	171	190	190	190	190			
23	9.70	22.6	42.1	78.6	113	147	179	199	199	199	199			
24	10.1	23.6	44.1	82.3	119	154	188	209	209	209	209			
25	10.5	24.7	46.1	86.0	124	161	196	222	222	222	222	222		
26	11.0	25.8	48.1	89.7	129	167	205	235	235	235	235	235		
28	11.8	27.9	52.1	97.2	140	181	222	261	263	263	263	263		
30	12.6	30.1	56.1	105	151	195	239	282	292	292	292	292		
32	13.5	32.3	60.2	112	162	210	256	302	313	313	313	313		
35	14.8	35.5	66.3	124	178	231	282	333	345	345	345	345		
40	16.9	41.0	76.6	143	206	267	326	384	398	398	398	398		
45	19.0	46.6	87.0	162	234	303	370	436	464	464	464	464	464	

Note: 1. Use RS Roller Chains in the high speed range.

2. Maximum allowable load when using a four-pitch offset link (OL) is 85% that of the above values.

Multi-strand factor	Number of chain strands		Multi-strand factor	
	Double strand			1.7
	Triple strand			2.5

Lubrication method	A II	drip lubrication	Details on Pg. 202
	B	Oil bath or slinger disc lubrication	
	C	Forced pump lubrication	

Before Use
Standard Roller Chains
Lube-Free Roller Chains
Heavy Duty Roller Chains
Corrosion Resistant Roller Chains
Specialty Roller Chains
Sprockets
Pin Gear Drives
Accessories
Selection
Handling

Kilowatt Ratings Tables (RS160-SUP~RS240-SUP)

Before Use
Standard Roller Chains
Lube-Free Roller Chains
Heavy Duty Roller Chains
Corrosion Resistant Roller Chains
Specialty Roller Chains
Sprockets
Pin Gear Drives
Accessories
Handling

■RS160-SUP-1 Maximum Kilowatt Ratings Table
(kW Ratings for Single Strand Chain)

Lubrication Type Small Sprocket No. of Teeth	Small Sprocket Max rpm										
	10	25	50	100	150	200	250	300	350	400	450
	A II		B	C							
13	7.89	18.0	33.6	62.7	90.3	117	129	129	129		
14	8.55	19.5	36.4	67.9	97.8	127	145	145	145	145	
15	9.21	21.0	39.2	73.1	105	136	160	160	160	160	
16	9.87	22.5	42.0	78.4	113	146	177	177	177	177	
17	10.5	24.0	44.9	83.7	121	156	191	193	193	193	
18	11.2	25.6	47.7	89.1	128	166	203	207	207	207	
19	11.8	27.1	50.6	94.4	136	176	215	219	219	219	
20	12.4	28.7	53.5	99.8	144	186	228	232	232	232	
21	13.1	30.2	56.4	105	152	196	240	244	244	244	
22	13.7	31.8	59.3	111	159	206	252	257	257	257	
23	14.3	33.3	62.2	116	167	217	265	270	270	270	
24	14.9	34.9	65.1	122	175	227	277	282	282	282	
25	15.6	36.5	68.1	127	183	237	290	295	295	295	
26	16.2	38.0	71.0	132	191	247	302	308	308	308	
28	17.4	41.2	76.9	144	207	268	327	343	343	343	343
30	18.7	44.4	82.9	155	223	289	353	380	380	380	380
32	19.9	47.6	88.8	166	239	309	378	419	419	419	419
35	21.8	52.4	97.9	183	263	341	417	472	472	472	472
40	24.9	60.6	113	211	304	394	481	545	545	545	545
45	28.0	68.8	128	240	345	447	547	619	619	619	619

■RS180-SUP-1 Maximum Kilowatt Ratings Table
(kW Ratings for Single Strand Chain)

Lubrication Type Small Sprocket No. of Teeth	Small Sprocket Max rpm									
	10	25	50	100	150	200	250	300	350	400
	A II		B	C						
13	10.3	23.6	44.1	82.2	118	153	173	173	173	
14	11.2	25.6	47.7	89.1	128	166	187	187	187	
15	12.1	27.6	51.4	95.9	138	179	202	202	202	
16	13.0	29.5	55.1	103	148	192	216	216	216	
17	13.8	31.5	58.9	110	158	205	231	231	231	
18	14.7	33.5	62.6	117	168	218	245	245	245	
19	15.5	35.6	66.4	124	178	231	260	260	260	
20	16.3	37.6	70.2	131	189	244	275	275	275	
21	17.1	39.6	73.9	138	199	257	290	290	290	
22	18.0	41.7	77.8	145	209	271	305	305	305	
23	18.8	43.7	81.6	152	219	284	320	320	320	
24	19.6	45.8	85.4	159	230	297	335	335	335	
25	20.4	47.8	89.3	167	240	311	350	350	350	
26	21.2	49.9	93.1	174	250	324	365	365	365	
28	22.9	54.1	101	188	271	351	429	446	446	446
30	24.5	58.2	109	203	292	378	463	481	481	481
32	26.1	62.5	117	217	313	406	496	515	515	515
35	28.6	68.8	128	240	345	447	546	568	568	568
40	32.7	79.5	148	277	399	516	631	656	656	656
45	36.7	90.3	168	314	453	586	717	745	745	745

■RS200-SUP-1 Maximum Kilowatt Ratings Table
(kW Ratings for Single Strand Chain)

Lubrication Type Small Sprocket No. of Teeth	Small Sprocket Max rpm												
	10	15	20	30	40	50	70	100	150	200	250	300	350
	A II		B			C							
13	13.4	19.3	25.0	36.1	46.7	57.1	77.3	107	154	194	194	194	194
14	14.5	20.9	27.1	39.1	50.6	61.9	83.8	115	166	211	211	211	211
15	15.7	22.6	29.2	42.1	54.5	66.7	90.2	124	179	232	234	234	234
16	16.8	24.2	31.3	45.1	58.5	71.5	96.8	133	192	249	258	258	258
17	17.9	25.8	33.5	48.2	62.4	76.3	103	142	205	266	283	283	283
18	19.1	27.5	35.6	51.3	66.4	81.2	110	151	218	283	308	308	308
19	20.1	29.1	37.7	54.3	70.4	86.0	116	161	231	300	334	334	334
20	21.2	30.8	39.9	57.4	74.4	91.0	123	170	244	317	355	355	355
21	22.2	32.4	42.0	60.5	78.4	95.9	130	179	258	334	374	374	374
22	23.3	34.1	44.2	63.7	82.5	101	136	188	271	351	393	393	393
23	24.3	35.8	46.4	66.8	86.5	106	143	197	284	368	412	412	412
24	25.4	37.5	48.5	69.9	90.6	111	150	207	298	386	432	432	432
25	26.5	39.2	50.7	73.1	94.7	116	157	216	311	403	451	451	451
26	27.5	40.9	52.9	76.2	98.8	121	163	225	325	420	471	471	471

■RS240-SUP-1 Maximum Kilowatt Ratings Table
(kW Ratings for Single Strand Chain)

Lubrication Type Small Sprocket No. of Teeth	Small Sprocket Max rpm																
	5	10	15	20	25	30	40	50	60	80	100	125	150	175	200	250	300
	A II		B			C											
13	11.5	22.4	32.2	41.8	51.1	60.2	77.9	95.3	112	145	178	217	256	276	276	276	276
14	12.4	24.2	34.9	45.2	55.3	65.2	84.4	103	122	158	193	235	277	308	308	308	308
15	13.2	26.1	37.6	48.7	59.6	70.2	91.0	111	131	170	207	254	299	341	341	341	341
16	14.1	28.0	40.3	52.3	63.9	75.3	97.5	119	140	182	222	272	320	368	376	376	376
17	15.0	29.9	43.1	55.8	68.2	80.4	104	127	150	194	238	290	342	393	412	412	412
18	15.9	31.8	45.8	59.4	72.6	85.5	111	135	160	207	253	309	364	418	449	449	449
19	16.8	33.5	48.6	62.9	76.9	90.6	117	144	169	219	268	327	386	443	483	483	483
20	17.7	35.3	51.3	66.5	81.3	95.8	124	152	179	232	283	346	408	468	510	510	510
21	18.5	37.1	54.1	70.1	85.7	101	131	160	188	244	298	365	430	494	538	538	538
22	19.4	38.8	56.9	73.7	90.1	106	138	168	198	257	314	384	452	519	565	565	565
23	20.3	40.6	59.7	77.3	94.5	111	144	176	208	269	329	402	474	545	593	593	593
24	21.2	42.4	62.5	81.0	99.0	117	151	185	218	282	345	421	497	570	621	621	621
25	22.1	44.1	65.3	84.6	104	122	158	193	227	295	360	440	519	596	649	649	649
26	22.9	45.9	68.2	88.3	108	127	165	201	237	307	376	459	541	622	677	677	677

Note: 1. Use RS Roller Chains in the high speed range.
2. Maximum allowable load when using a four-pitch offset link (OL) is 85% that of the above values.

Multi-strand factor	Number of chain strands	Multi-strand factor
	Double strand	1.7
	Triple strand	2.5

Lubrication method	A II	drip lubrication	Details on Pg. 202
	B	Oil bath or slinger disc lubrication	
	C	Forced pump lubrication	

RS-HT Chain

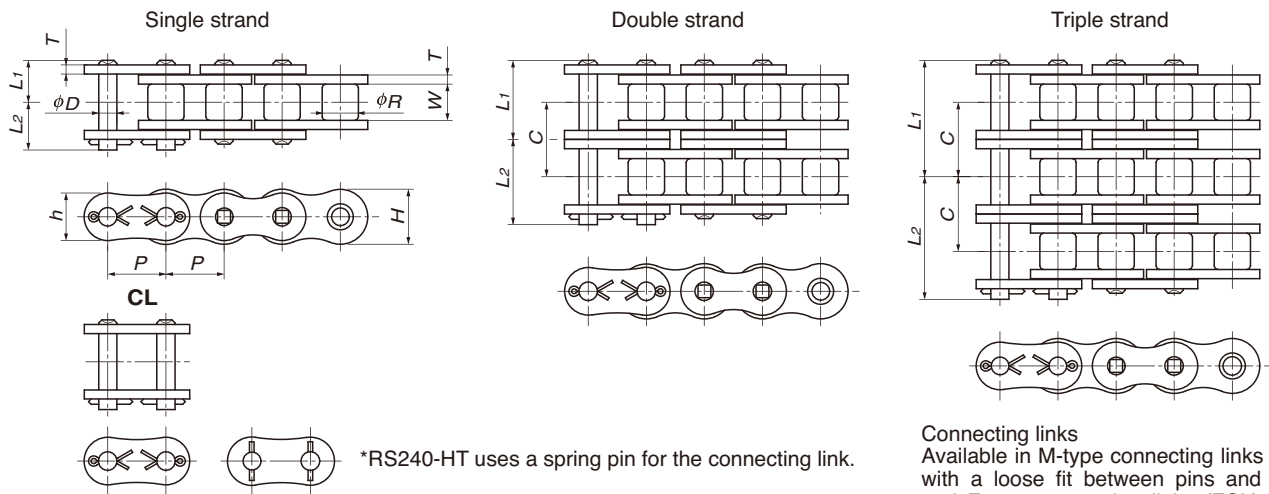

*RS240-HT uses a spring pin for the connecting link.

Connecting links
Available in M-type connecting links (MCL) with a loose fit between pins and plates and F-type connecting links (FCL) with a tight fit between pins and plates.

TSUBAKI Chain Number	Pitch P	Roller Diameter R	Inner Width of Inner Link W	Plates			Pins D
				Thickness T	Height H	Height h	
RS60-HT-1 RS60-HT-2 RS60-HT-3	19.05	11.91	12.70	3.2	18.1	15.6	5.96
RS80-HT-1 RS80-HT-2 RS80-HT-3	25.40	15.88	15.88	4.0	24.1	20.8	7.94
RS100-HT-1 RS100-HT-2 RS100-HT-3	31.75	19.05	19.05	4.8	30.1	26.0	9.54
RS120-HT-1 RS120-HT-2 RS120-HT-3	38.10	22.23	25.40	5.6	36.2	31.2	11.11
RS140-HT-1 RS140-HT-2 RS140-HT-3	44.45	25.40	25.40	6.4	42.2	36.4	12.71
RS160-HT-1 RS160-HT-2 RS160-HT-3	50.80	28.58	31.75	7.15	48.2	41.6	14.29
RS200-HT-1 RS200-HT-2 RS200-HT-3	63.50	39.68	38.10	9.5	60.3	52.0	19.85
RS240-HT-1 RS240-HT-2 RS240-HT-3	76.20	47.63	47.63	12.7	72.4	62.4	23.81

TSUBAKI Chain Number	Number of Strands	Dimensions L1	Dimensions L2	Transverse Pitch C	Minimum Tensile Strength kN {kgf}	Average Tensile Strength kN {kgf}	Maximum Allowable Load kN {kgf}	Approximate Mass kg/m	Links Per Unit
RS60-HT-1	1	14.8	17.0	-	48.1 { 4900 }	55.9 { 5700 }	9.81 { 1000 }	1.80	160
RS60-HT-2	2	27.8	29.9	26.1	96.1 { 9800 }	112 { 11400 }	16.7 { 1700 }	3.59	
RS60-HT-3	3	40.85	42.95	26.1	144 { 14700 }	168 { 17100 }	24.5 { 2500 }	5.36	
RS80-HT-1	1	18.3	20.9	-	81.4 { 8300 }	93.2 { 9500 }	16.2 { 1650 }	3.11	120
RS80-HT-2	2	34.6	37.2	32.6	163 { 16600 }	186 { 19000 }	27.6 { 2810 }	6.18	
RS80-HT-3	3	50.95	53.55	32.6	244 { 24900 }	279 { 28500 }	40.5 { 4130 }	9.24	
RS100-HT-1	1	21.8	24.5	-	124 { 12600 }	142 { 14500 }	24.5 { 2500 }	4.58	96
RS100-HT-2	2	41.4	44.1	39.1	247 { 25200 }	284 { 29000 }	41.7 { 4250 }	9.03	
RS100-HT-3	3	61.0	63.6	39.1	371 { 37800 }	427 { 43500 }	61.3 { 6250 }	13.54	
RS120-HT-1	1	26.95	30.55	-	167 { 17000 }	191 { 19500 }	32.4 { 3300 }	6.53	80
RS120-HT-2	2	51.4	55.0	48.9	333 { 34000 }	382 { 39000 }	55.0 { 5610 }	12.90	
RS120-HT-3	3	75.9	79.4	48.9	500 { 51000 }	574 { 58500 }	80.9 { 8250 }	19.33	
RS140-HT-1	1	28.9	33.1	-	218 { 22200 }	250 { 25500 }	42.7 { 4350 }	8.27	68
RS140-HT-2	2	55.0	59.5	52.2	435 { 44400 }	500 { 51000 }	72.6 { 7400 }	16.38	
RS140-HT-3	3	81.15	85.25	52.2	653 { 66600 }	750 { 76500 }	107 { 10880 }	24.54	
RS160-HT-1	1	33.95	38.45	-	278 { 28300 }	319 { 32500 }	55.9 { 5700 }	10.97	60
RS160-HT-2	2	64.9	69.6	61.9	555 { 56600 }	638 { 65000 }	95 { 9690 }	21.78	
RS160-HT-3	3	95.95	100.45	61.9	833 { 84900 }	956 { 97500 }	140 { 14250 }	32.63	
RS200-HT-1	1	42.9	48.1	-	486 { 49600 }	559 { 57000 }	78.5 { 8000 }	18.41	48
RS200-HT-2	2	82.05	87.3	78.3	973 { 99200 }	1120 { 114000 }	133 { 13600 }	36.47	
RS200-HT-3	3	121.25	126.55	78.3	1460 { 148800 }	1680 { 171000 }	196 { 20000 }	54.77	
RS240-HT-1	1	54.8	62.3	-	768 { 78300 }	883 { 90000 }	113 { 11500 }	29.13	40
RS240-HT-2	2	105.3	112.9	101.2	1540 { 156600 }	1770 { 180000 }	192 { 19550 }	57.35	
RS240-HT-3	3	156.05	163.55	101.2	2300 { 234900 }	2650 { 270000 }	282 { 28750 }	85.47	

- Note: 1. No offset links available.
 2. Made-to-order product.
 3. The dimensions shown in this catalog are nominal dimensions and differ from actual dimensions.
 4. RS Roller Chain sprockets can be used only with single strand chains. Steel sprockets cannot be used. Use sprockets made of S35C or higher carbon steel. Sprockets with lower teeth number must also have hardened teeth. Check key strength, etc.
 5. Tsubaki offers TOUGH TOOTH sprockets (pgs. 103 – 105) with increased hub strength.

Before Use
 Standard Roller Chains
 Lubrication
 Heavy Duty Roller Chains
 Corrosion Resistant Roller Chains
 Specialty Roller Chains
 Sprockets
 Pin Gear Drives
 Accessories
 Selection
 Handling

Kilowatt Ratings Tables (RS60-HT~RS120-HT)

RS60-HT-1 Maximum Kilowatt Ratings Table
(kW Ratings for Single Strand Chain)

Lubrication Type Small Sprocket No. of Teeth	Small Sprocket Max rpm															
	10	25	50	100	150	200	300	400	500	600	700	800	900	1000	1100	1200
	A						B						C			
9	0.27	0.61	1.13	2.11	3.04	3.93	5.67	7.34	8.98	10.1	10.1	10.1	10.1			
10	0.30	0.68	1.27	2.36	3.40	4.41	6.35	8.23	10.1	11.4	11.4	11.4	11.4			
11	0.33	0.75	1.40	2.62	3.77	4.89	7.04	9.12	11.1	12.7	12.7	12.7	12.7			
12	0.36	0.83	1.54	2.88	4.14	5.37	7.73	10.0	12.2	13.9	13.9	13.9	13.9			
13	0.39	0.90	1.68	3.14	4.52	5.85	8.43	10.9	13.4	15.2	15.2	15.2	15.2			
14	0.43	0.98	1.82	3.40	4.89	6.34	9.13	11.8	14.5	16.7	16.7	16.7	16.7			
15	0.46	1.05	1.96	3.66	5.27	6.83	9.84	12.7	15.6	18.4	18.5	18.5	18.5			
16	0.49	1.13	2.10	3.93	5.65	7.32	10.6	13.7	16.7	19.7	20.4	20.4	20.4			
17	0.53	1.20	2.25	4.19	6.04	7.82	11.3	14.6	17.8	21.0	22.3	22.3	22.3			
18	0.56	1.28	2.39	4.46	6.42	8.32	12.0	15.5	19.0	22.4	23.7	23.7	23.7			
19	0.59	1.36	2.53	4.73	6.81	8.82	12.7	16.5	20.1	23.7	25.1	25.1	25.1			
20	0.62	1.43	2.68	4.99	7.19	9.32	13.4	17.4	21.3	25.1	26.6	26.6	26.6			
21	0.65	1.51	2.82	5.27	7.58	9.83	14.2	18.3	22.4	26.4	28.0	28.0	28.0			
22	0.69	1.59	2.97	5.54	7.97	10.3	14.9	19.3	23.6	27.8	29.5	29.5	29.5			
23	0.72	1.67	3.11	5.81	8.37	10.8	15.6	20.2	24.7	29.1	30.9	30.9	30.9			
24	0.75	1.75	3.26	6.08	8.76	11.3	16.3	21.2	25.9	30.5	32.5	32.5	32.5	32.5		
25	0.78	1.83	3.41	6.36	9.16	11.9	17.1	22.1	27.1	31.9	34.5	34.5	34.5	34.5		
26	0.81	1.90	3.55	6.63	9.55	12.4	17.8	23.1	28.2	33.3	36.6	36.6	36.6	36.6		
28	0.87	2.06	3.85	7.18	10.3	13.4	19.3	25.0	30.6	36.0	40.9	40.9	40.9	40.9		
30	0.93	2.22	4.15	7.74	11.1	14.4	20.8	26.9	32.9	38.8	44.6	44.9	44.9	44.9	44.9	
32	1.00	2.38	4.45	8.30	12.0	15.5	22.3	28.9	35.3	41.6	47.8	48.1	48.1	48.1	48.1	
35	1.09	2.63	4.90	9.14	13.2	17.1	24.6	31.8	38.9	45.9	52.7	53.0	53.0	53.0	53.0	
40	1.25	3.03	5.66	10.6	15.2	19.7	28.4	36.8	44.9	53.0	60.8	61.3	61.3	61.3	61.3	
45	1.40	3.44	6.43	12.0	17.3	22.4	32.2	41.8	51.0	60.1	69.1	73.2	73.2	73.2	73.2	

RS80-HT-1 Maximum Kilowatt Ratings Table
(kW Ratings for Single Strand Chain)

Lubrication Type Small Sprocket No. of Teeth	Small Sprocket Max rpm												
	10	25	50	100	150	200	300	400	500	600	700		
	A						B						C
9	0.58	1.33	2.49	4.64	6.69	8.66	12.5	16.2	18.2	18.2			
10	0.65	1.49	2.79	5.20	7.49	9.71	14.0	18.1	20.4	20.4			
11	0.73	1.66	3.09	5.77	8.31	10.8	15.5	20.1	22.6	22.6			
12	0.80	1.82	3.39	6.33	9.12	11.8	17.0	22.1	24.9	24.9			
13	0.87	1.98	3.70	6.91	9.95	12.9	18.6	24.0	27.1	27.1			
14	0.94	2.15	4.01	7.48	10.8	14.0	20.1	26.1	29.4	29.4			
15	1.01	2.31	4.32	8.06	11.6	15.0	21.7	28.1	32.6	32.6			
16	1.09	2.48	4.63	8.64	12.4	16.1	23.2	30.1	35.9	35.9			
17	1.16	2.65	4.94	9.23	13.3	17.2	24.8	32.1	39.3	39.3			
18	1.23	2.82	5.26	9.82	14.1	18.3	26.4	34.2	41.8	42.8			
19	1.30	2.99	5.58	10.4	15.0	19.4	28.0	36.2	44.3	46.0			
20	1.37	3.16	5.89	11.0	15.8	20.5	29.6	38.3	46.8	48.7			
21	1.44	3.33	6.21	11.6	16.7	21.6	31.2	40.4	49.3	51.3			
22	1.51	3.50	6.53	12.2	17.6	22.7	32.8	42.4	51.9	53.9			
23	1.58	3.67	6.85	12.8	18.4	23.9	34.4	44.5	54.4	56.6			
24	1.65	3.85	7.18	13.4	19.3	25.0	36.0	46.6	57.0	59.3			
25	1.71	4.02	7.50	14.0	20.2	26.1	37.6	48.7	59.6	61.9			
26	1.78	4.19	7.82	14.6	21.0	27.2	39.2	50.8	62.2	64.6			
28	1.92	4.54	8.48	15.8	22.8	29.5	42.5	55.1	67.3	70.0			
30	2.06	4.89	9.13	17.0	24.5	31.8	45.8	59.3	72.5	77.2			
32	2.19	5.25	9.79	18.3	26.3	34.1	49.1	63.6	77.8	85.0	85.0		
35	2.40	5.78	10.8	20.1	29.0	37.6	54.1	70.1	85.7	97.3	97.3		
40	2.74	6.68	12.5	23.2	33.5	43.4	62.5	81.0	99.0	114	114		
45	3.09	7.58	14.1	26.4	38.0	49.3	71.0	91.9	112	130	130		

RS100-HT-1 Maximum Kilowatt Ratings Table
(kW Ratings for Single Strand Chain)

Lubrication Type Small Sprocket No. of Teeth	Small Sprocket Max rpm								
	10	25	50	100	150	200	300	400	500
	A				B				
9	1.10	2.52	4.70	8.78	12.6	16.4	23.6	26.4	
10	1.24	2.82	5.27	9.83	14.2	18.4	26.4	29.6	
11	1.37	3.13	5.84	10.9	15.7	20.3	29.3	32.8	
12	1.51	3.44	6.42	12.0	17.2	22.3	32.2	36.1	
13	1.64	3.75	7.00	13.1	18.8	24.4	35.1	39.3	
14	1.78	4.06	7.58	14.1	20.4	26.4	38.0	42.9	
15	1.92	4.38	8.17	15.2	21.9	28.4	41.0	47.6	
16	2.06	4.69	8.76	16.3	23.5	30.5	43.9	52.4	
17	2.20	5.01	9.35	17.4	25.1	32.6	46.9	57.4	57.4
18	2.33	5.33	9.94	18.6	26.7	34.6	49.9	62.5	62.5
19	2.46	5.65	10.5	19.7	28.3	36.7	52.9	67.8	67.8
20	2.59	5.97	11.1	20.8	29.9	38.8	55.9	71.9	71.9
21	2.72	6.29	11.7	21.9	31.6	40.9	58.9	75.8	75.8
22	2.85	6.62	12.3	23.0	33.2	43.0	61.9	79.7	79.7
23	2.98	6.94	13.0	24.2	34.8	45.1	65.0	83.7	83.7
24	3.11	7.27	13.6	25.3	36.5	47.2	68.0	87.6	87.6
25	3.24	7.60	14.2	26.5	38.1	49.4	71.1	91.5	91.5
26	3.37	7.93	14.8	27.6	39.8	51.5	74.2	95.5	95.5
28	3.63	8.59	16.0	29.9	43.1	55.8	80.4	103	103
30	3.89	9.25	17.3	32.2	46.4	60.1	86.6	111	111
32	4.15	9.92	18.5	34.5	49.8	64.5	92.8	120	121
35	4.54	10.9	20.4	38.0	54.8	71.0	102	132	139
40	5.19	12.6	23.6	44.0	63.3	82.0	118	153	170
45	5.83	14.3	26.7	49.9	71.9	93.1	134	174	196

RS120-HT-1 Maximum Kilowatt Ratings Table
(kW Ratings for Single Strand Chain)

Lubrication Type Small Sprocket No. of Teeth	Small Sprocket Max rpm									
	10	25	50	100	150	200	300	400	500	
	A			B						C
9	1.75	4.00	7.46	13.9	20.1	26.0	37.4	41.1		
10	1.96	4.48	8.36	15.6	22.5	29.1	41.9	46.1		
11	2.18	4.97	9.27	17.3	24.9	32.3	46.5	51.0		
12	2.39	5.46	10.2	19.0	27.4	35.5	51.1	56.1		
13	2.61	5.95	11.1	20.7	29.8	38.7	55.7	61.1		
14	2.83	6.45	12.0	22.4	32.3	41.9	60.3	66.2		
15	3.04	6.94	13.0	24.2	34.8	45.1	65.0	71.3		
16	3.26	7.45	13.9	25.9	37.3	48.4	69.7	76.5		
17	3.49	7.95	14.8	27.7	39.9	51.7	74.4	83.7		
18	3.70	8.46	15.8	29.4	42.4	54.9	79.1	91.2		
19	3.91	8.96	16.7	31.2	45.0	58.3	83.9	98.9		
20	4.11	9.47	17.7	33.0	47.5	61.6	88.7	107		
21	4.32	9.99	18.6	34.8	50.1	64.9	93.5	115	115	
22	4.53	10.5	19.6	36.6	52.7	68.2	98.3	123	123	
23	4.73	11.0	20.6	38.4	55.3	71.6	103	132	132	
24	4.94	11.5	21.5	40.2	57.9	75.0	108	140	140	
25	5.14	12.1	22.5	42.0	60.5	78.3	113	146	146	
26	5.35	12.6	23.5	43.8	63.1	81.7	118	152	152	
28	5.76	13.6	25.4	47.5	68.3	88.5	128	165	165	
30	6.17	14.7	27.4	51.1	73.6	95.4	137	178	178	
32	6.58	15.7	29.4	54.8	79.0	102	147	191	191	
35	7.20	17.3	32.4	60.4	87.0	113	162	210	210	
40	8									

Kilowatt Ratings Tables (RS140HT~RS240HT)

■RS140-HT-1 Maximum Kilowatt Ratings Table (kW Ratings for Single Strand Chain)

Lubrication Type Small Sprocket No. of Teeth	Small Sprocket Max rpm										
	10	25	50	100	150	200	250	300	350	400	450
	A			B						C	
9	2.70	6.15	11.5	21.4	30.8	40.0	48.9	56.1	56.1		
10	3.02	6.89	12.9	24.0	34.6	44.8	54.7	64.5	65.6		
11	3.35	7.64	14.3	26.6	38.3	49.6	60.7	71.5	72.7		
12	3.68	8.39	15.7	29.2	42.1	54.5	66.7	78.5	79.9		
13	4.01	9.15	17.1	31.9	45.9	59.4	72.7	85.6	87.1		
14	4.34	9.91	18.5	34.5	49.7	64.4	78.7	92.8	94.4		
15	4.68	10.7	19.9	37.2	53.6	69.4	84.8	100	103		
16	5.02	11.4	21.4	39.9	57.4	74.4	90.9	107	114		
17	5.36	12.2	22.8	42.6	61.3	79.4	97.1	114	124		
18	5.69	13.0	24.3	45.3	65.2	84.5	103	122	136	136	
19	6.01	13.8	25.7	48.0	69.1	89.6	109	129	144	144	
20	6.33	14.6	27.2	50.7	73.1	94.7	116	136	152	152	
21	6.64	15.4	28.7	53.5	77.0	100	122	144	161	161	
22	6.96	16.1	30.1	56.2	81.0	105	128	151	169	169	
23	7.28	16.9	31.6	59.0	85.0	110	135	159	177	177	
24	7.59	17.7	33.1	61.8	89.0	115	141	166	186	186	
25	7.91	18.5	34.6	64.6	93.0	120	147	174	194	194	
26	8.22	19.3	36.1	67.3	97.0	126	154	181	204	204	
28	8.86	21.0	39.1	73.0	105	136	166	196	225	228	
30	9.49	22.6	42.1	78.6	113	147	179	211	243	253	
32	10.1	24.2	45.2	84.3	121	157	192	227	260	276	
35	11.1	26.7	49.8	92.8	134	173	212	250	287	304	
40	12.7	30.8	57.5	107	154	200	245	288	331	351	
45	14.2	35.0	65.3	122	175	227	278	327	376	408	408

■RS160-HT-1 Maximum Kilowatt Ratings Table (kW Ratings for Single Strand Chain)

Lubrication Type Small Sprocket No. of Teeth	Small Sprocket Max rpm									
	10	25	50	100	150	200	250	300	350	400
	A			B						C
9	4.03	9.20	17.2	32.0	46.2	59.8	73.1	74.5		
10	4.52	10.3	19.2	35.9	51.7	67.0	81.9	87.3		
11	5.01	11.4	21.3	39.8	57.3	74.3	90.8	98.5		
12	5.50	12.6	23.4	43.7	63.0	81.6	100	108		
13	6.00	13.7	25.5	47.7	68.7	88.9	109	118		
14	6.50	14.8	27.7	51.6	74.4	96.4	118	128		
15	7.00	16.0	29.8	55.6	80.1	104	127	138		
16	7.51	17.1	32.0	59.6	85.9	111	136	148		
17	8.02	18.3	34.1	63.7	91.7	119	145	162		
18	8.52	19.5	36.3	67.7	97.6	126	155	177	177	
19	8.99	20.6	38.5	71.8	103	134	164	192	192	
20	9.47	21.8	40.7	75.9	109	142	173	204	207	
21	9.94	23.0	42.9	80.0	115	149	183	215	220	
22	10.4	24.2	45.1	84.1	121	157	192	226	231	
23	10.9	25.3	47.3	88.3	127	165	201	237	243	
24	11.4	26.5	49.5	92.4	133	172	211	248	254	
25	11.8	27.7	51.8	96.6	139	180	220	260	266	
26	12.3	28.9	54.0	101	145	188	230	271	277	
28	13.3	31.3	58.5	109	157	204	249	293	300	
30	14.2	33.8	63.0	118	169	219	268	316	325	
32	15.1	36.2	67.6	126	182	235	288	339	358	
35	16.6	39.9	74.4	139	200	259	317	373	409	409
40	18.9	46.1	86.0	160	231	299	366	431	485	485
45	21.3	52.3	97.6	182	262	340	416	490	551	551

■RS200-HT-1 Maximum Kilowatt Ratings Table (kW Ratings for Single Strand Chain)

Lubrication Type Small Sprocket No. of Teeth	Small Sprocket Max rpm											
	10	15	20	30	40	50	70	100	150	200	250	300
	A				B							C
9	7.08	10.2	13.2	19.0	24.7	30.1	40.8	56.2	81.0	105	108	
10	7.93	11.4	14.8	21.3	27.6	33.8	45.7	63.0	90.8	118	122	
11	8.79	12.7	16.4	23.6	30.6	37.4	50.7	69.9	101	130	135	
12	9.66	13.9	18.0	26.0	33.6	41.1	55.7	76.7	111	143	148	
13	10.5	15.2	19.7	28.3	36.7	44.8	60.7	83.7	121	156	161	
14	11.4	16.4	21.3	30.7	39.7	48.6	65.8	90.6	131	169	175	
15	12.3	17.7	22.9	33.0	42.8	52.3	70.8	97.6	141	182	192	
16	13.2	19.0	24.6	35.4	45.9	56.1	76.0	105	151	195	211	
17	14.1	20.3	26.3	37.8	49.0	59.9	81.1	112	161	209	231	
18	15.0	21.6	27.9	40.2	52.1	63.7	86.3	119	171	222	252	252
19	15.8	22.9	29.6	42.7	55.3	67.5	91.4	126	182	235	273	273
20	16.6	24.2	31.3	45.1	58.4	71.4	96.6	133	192	249	290	290
21	17.4	25.5	33.0	47.5	61.6	75.3	102	140	202	262	305	305
22	18.3	26.8	34.7	50.0	64.7	79.1	107	148	213	276	321	321
23	19.1	28.1	36.4	52.4	67.9	83.0	112	155	223	289	337	337
24	19.9	29.4	38.1	54.9	71.1	86.9	118	162	234	303	353	353
25	20.8	30.7	39.8	57.4	74.3	90.9	123	170	244	316	369	369
26	21.6	32.1	41.6	59.9	77.5	94.8	128	177	255	330	385	385

■RS240-HT-1 Maximum Kilowatt Ratings Table (kW Ratings for Single Strand Chain)

Lubrication Type Small Sprocket No. of Teeth	Small Sprocket Max rpm															
	5	10	15	20	25	30	40	50	60	80	100	125	150	175	200	250
	A						B									
9	6.46	12.2	17.6	22.8	27.9	32.9	42.6	52.1	61.3	79.5	97.2	119	140	159	159	
10	7.18	13.7	19.7	25.6	31.3	36.8	47.7	58.3	68.7	89.1	109	133	157	180	183	183
11	7.89	15.2	21.9	28.3	34.7	40.8	52.9	64.7	76.2	98.7	121	148	174	200	202	202
12	8.61	16.7	24.0	31.1	38.1	44.9	58.1	71.0	83.7	108	133	162	191	219	222	222
13	9.33	18.2	26.2	34.0	41.5	48.9	63.4	77.4	91.3	118	145	177	208	239	242	242
14	10.0	19.7	28.4	36.8	45.0	53.0	68.6	83.9	98.9	128	157	191	226	259	263	263
15	10.8	21.2	30.6	39.6	48.4	57.1	73.9	90.4	107	138	169	206	243	279	283	283
16	11.5	22.8	32.8	42.5	51.9	61.2	79.3	96.9	114	148	181	221	261	299	299	299
17	12.2	24.3	35.0	45.4	55.5	65.3	84.6	103	122	158	193	236	278	300	300	
18	12.9	25.8	37.2	48.3	59.0	69.5	90.0	110	130	168	205	251	296	303	303	
19	13.6	27.3	39.5	51.2	62.5	73.7	95.5	117	137	178	218	266	314	317	317	
20	14.4	28.7	41.7	54.1	66.1	77.9	101	123	145	188	230	281	330	330		
21	15.1	30.1	44.0	57.0	69.7	82.1	106	130	153	198	243	297	345	345		
22	15.8	31.6	46.3	59.9	73.3	86.3	112	137	161	209	255	312	346	346		
23	16.5	33.0	48.5	62.9	76.9	90.6	117	143	169	219	268	327	370	370		
24	17.2	34.4	50.8	65.8	80.5	94.8	123	150	177	229	280	343	396	396		
25	17.9	35.9	53.1	68.8	84.1	99.1	128	157	185	240	293	358	410	410		
26	18.7	37.3	55.4	71.8	87.7	103	134	164	193	250	306	373	418	418		

Note: 1. Use RS Roller Chains in the high speed range.

Multi-strand factor	Number of chain strands		Multi-strand factor	
	Double strand			1.7
	Triple strand			2.5

Lubrication method	A	Manual lubrication or drip lubrication	Details on Pg. 202
	B	Oil bath or slinger disc lubrication	
	C	Forced pump lubrication	

Before Use Standard Roller Chains Lubrication-Free Roller Chains Heavy Duty Roller Chains Corrosion Resistant Roller Chains Specialty Roller Chains Sprockets Pin Gear Drives Accessories Selection Handling

Super-H Roller Chain

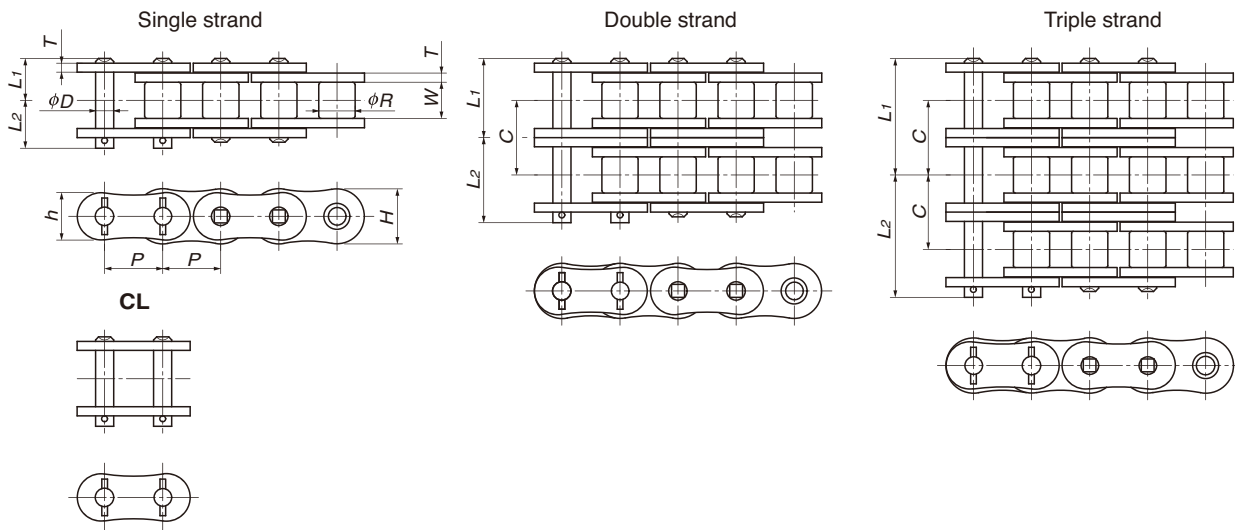

TSUBAKI Chain Number	Number of Strands	Pitch P	Roller Diameter R	Inner Width of Inner Link W	Plates			Pins			Transverse Pitch C	Minimum Tensile Strength $kN\{kgf\}$	Average Tensile Strength $kN\{kgf\}$	Maximum Allowable Load $kN\{kgf\}$	Approximate Mass kg/m
					Thickness T	Width H	Width h	Diameter D	L_1	L_2					
RS80-SUP-H-1	1								18.3	20.9	–	85.3 { 8700 }	98.1 { 10000 }	25.0 { 2550 }	3.29
RS80-SUP-H-2	2	25.40	15.88	15.88	4.0	24.1	20.8	7.94	34.6	37.2	32.6	171 { 17400 }	196 { 20000 }	42.0 { 4280 }	6.52
RS80-SUP-H-3	3								50.95	53.55	32.6	256 { 26100 }	294 { 30000 }	61.8 { 6300 }	9.75
RS100-SUP-H-1	1								21.8	24.5	–	127 { 12900 }	145 { 14800 }	39.2 { 4000 }	4.88
RS100-SUP-H-2	2	31.75	19.05	19.05	4.8	30.1	26.0	9.54	41.4	44.1	39.1	253 { 25800 }	290 { 29600 }	66.7 { 6800 }	9.51
RS100-SUP-H-3	3								61.0	63.6	39.1	380 { 38700 }	435 { 44400 }	98.1 { 10000 }	14.14
RS120-SUP-H-1	1								26.95	30.55	–	171 { 17400 }	196 { 20000 }	53.9 { 5500 }	6.94
RS120-SUP-H-2	2	38.10	22.23	25.40	5.6	36.2	31.2	11.11	51.4	55.0	48.9	341 { 34800 }	392 { 40000 }	91.7 { 9350 }	13.51
RS120-SUP-H-3	3								75.9	79.4	48.9	512 { 52200 }	588 { 60000 }	135 { 13750 }	20.09
RS140-SUP-H-1	1								28.9	33.1	–	222 { 22600 }	255 { 26000 }	68.4 { 6970 }	8.88
RS140-SUP-H-2	2	44.45	25.40	25.40	6.4	42.2	36.4	12.71	55.0	59.5	52.2	443 { 45200 }	510 { 52000 }	108 { 11050 }	17.38
RS140-SUP-H-3	3								81.15	85.25	52.2	665 { 67800 }	765 { 78000 }	159 { 16250 }	25.88
RS160-SUP-H-1	1								33.95	38.45	–	281 { 28700 }	324 { 33000 }	90.0 { 9180 }	11.72
RS160-SUP-H-2	2	50.80	28.58	31.75	7.15	48.2	41.6	14.29	64.9	69.6	61.9	563 { 57400 }	647 { 66000 }	145 { 14790 }	22.97
RS160-SUP-H-3	3								95.95	100.45	61.9	844 { 86100 }	971 { 99000 }	213 { 21750 }	34.22
RS200-SUP-H-1	1								42.9	48.1	–	520 { 53000 }	598 { 61000 }	122 { 12410 }	19.68
RS200-SUP-H-2	2	63.50	39.68	38.10	9.5	60.3	52.0	19.85	82.05	87.3	78.3	1040 { 106000 }	1200 { 122000 }	183 { 18700 }	38.48
RS200-SUP-H-3	3								121.25	126.55	78.3	1560 { 159000 }	1790 { 183000 }	270 { 27500 }	57.29
RS240-SUP-H-1	1								54.8	62.3	–	802 { 81800 }	922 { 94000 }	168 { 17170 }	30.47
RS240-SUP-H-2	2	76.20	47.63	47.63	12.7	72.4	62.4	23.81	105.3	112.9	101.2	1600 { 163600 }	1840 { 188000 }	257 { 26180 }	59.77
RS240-SUP-H-3	3								156.05	163.55	101.2	2410 { 245400 }	2770 { 282000 }	378 { 38500 }	89.09

Note: 1. Made-to-order product.
 2. The dimensions shown in this catalog are nominal dimensions and differ from actual dimensions.

Size	RS80-SUP-H	RS100-SUP-H	RS120-SUP-H	RS140-SUP-H	RS160-SUP-H	RS200-SUP-H	RS240-SUP-H
Number of Links Per Unit	120	96	80	68	60	48	40

Notes for use

- Select chains and sprockets as per the Allowable Load Selection Method.
- Offset links are not available due to the super heavy duty nature of transmission. Use an even number of links.
- Use drip lubrication, oil bath or splash lubrication, or forced pump lubrication.
- RS Roller Chain sprockets can be used only with single strand chains. Steel sprockets cannot be used. Use sprockets made of S35C or higher carbon steel. Sprockets with lower teeth number must also have hardened teeth. Check key strength, etc.
- Tsubaki offers TOUGH TOOTH sprockets (pgs. 103 – 105) with increased hub strength.

Ultra Super Roller Chain

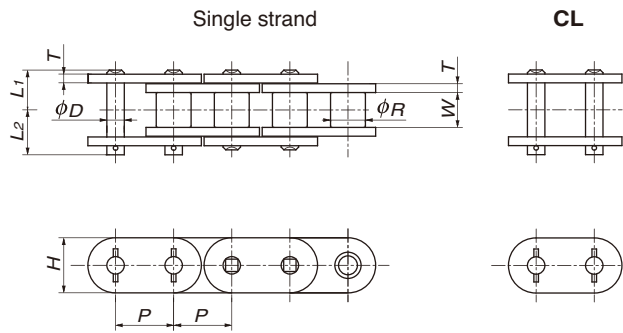

TSUBAKI Chain Number	Pitch P	Roller Diameter R	Inner Width of Inner Link W	Plates		Pins				Minimum Tensile Strength kN{kgf}	Maximum Allowable Load kN{kgf}	Approximate Mass kg/m
				Thickness T	Width H	Diameter D	L1 + L2	L1	L2			
RF100-US-N-1	31.75	19.05	19.05	4.8	30.1	9.54	46.3	21.8	24.5	149{15200}	39.2{4000}	5.07
RF120-US-N-1	38.10	22.23	25.40	5.6	36.2	11.11	57.5	26.95	30.55	213{21700}	53.9{5500}	7.22
RF140-US-N-1	44.45	25.40	25.40	6.4	42.2	12.71	62.0	28.9	33.1	273{27800}	68.4{6970}	9.24
RF160-US-N-1	50.80	28.58	31.75	7.15	48.2	14.29	72.4	33.95	38.45	341{34800}	90.0{9180}	12.19
RF200-US-N-1	63.50	39.68	38.10	9.5	60.3	19.85	91.0	42.9	48.1	580{59100}	122 {12410}	20.47
RF240-US-N-1	76.20	47.63	47.63	12.7	72.4	23.81	117.1	54.8	62.3	853{87000}	168 {17170}	31.69

Note: 1. Made-to-order product.
 2. The dimensions shown in this catalog are nominal dimensions and differ from actual dimensions.

Notes for use

- Select chains and sprockets as per the Allowable Load Selection Method.
- Offset links are not available due to the super heavy-duty nature of transmission. Use an even number of links.
- Use drip lubrication, oil bath or splash lubrication, or forced pump lubrication.
- RS Roller Chain sprockets can be used only with single strand chains. Steel sprockets cannot be used. Use sprockets made of S35C or higher carbon steel. Sprockets with lower teeth number must also have hardened teeth. Check key strength, etc.
- Check the keyway strength. Tsubaki offers TOUGH TOOTH sprockets (pgs. 103 – 105) with increased hub strength.
- Multi-strand chains are not available. Consider other heavy duty chains if required.
- The specifications changed from US to US-N in October 2016. The pin diameter D is thinner than with the previous specifications. Replace the entire chain when replacing the previous specifications with the new specifications. Minimum tensile strength and maximum allowable load are the same.

Corrosion Resistant Roller Chains

Stainless Steel Roller Chains

These roller chains are made of stainless steel. (See pg. 198 regarding the corrosion resistance of stainless steel drive chains.)

SS Series Basic stainless steel chain using SUS304 equivalent

These roller chains are made of 304 stainless steel (301 stainless steel clips). They offer greater corrosion resistance than RS Roller Chains and RS Surface Treated Roller Chains, and can be used in water and in corrosive atmospheres that are acidic or alkaline, as well as in low or high temperatures (-20 to 400°C). 304 stainless steel is only marginally magnetic. Some magnetism exists only due to the cold-forging process.

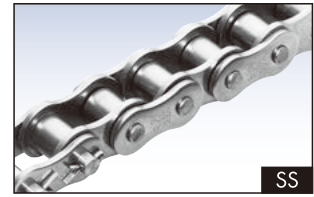

NS Series Highly corrosion resistant stainless steel chain using SUS316

These roller chains are made of 316 stainless steel (301 stainless steel clips on RS25NS, and 304 stainless steel cotter pins on RS80NS). They are suited for applications that require higher corrosion resistance than SS chains. Except for the clips, they are non-magnetic.

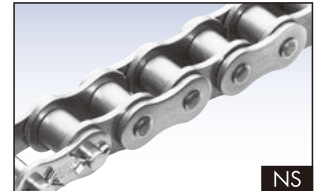

AS Series Stainless steel chain with 1.5 times the allowable load of SS Series

The pins and rollers of these roller chains are made of precipitation-hardened, tempered stainless steel, while the plates and bushes are 18-8SUS (304 stainless steel clips are 17-7SUS (301 stainless steel)). They have a maximum allowable load that is 1.5 times that of SS chains. Corrosion resistance is slightly less than that of SS chains. AS chains are suited for applications that require corrosion resistance, heat resistance, and smaller sizes / higher kilowatt ratings than SS chains. Because of its precipitation-hardened stainless steel, the chains are magnetic.



LSC Series Lube-free, long life stainless steel chain

This lube-free roller chain uses 18-8SUS (SUS304 equivalent) for the base chain and special engineering plastic sleeves in the bush. Suitable for situations requiring greater wear resistance than SS Series. Engineering plastic rollers also available.

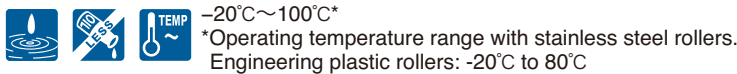

Surface Treated Roller Chains

These are surface-treated RS Roller Chains.

NP Series Nickel plating provides an attractive appearance

These chains are RS Roller Chains with nickel plating. The nickel plating not only improves the appearance, but also adds a small degree of corrosion resistance. Therefore, they can be used in applications where there is exposure to water. Bear in mind when making your selection that maximum allowable load is approximately 15% lower than with RS Roller Chains.

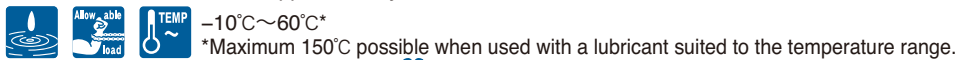

NEPTUNE CHAIN® RoHS compliant Uses a special coating for outstanding corrosion resistance

Neptune Chain is a surface treated chain that uses a base RS Roller Chain with a special coating and top coating. Neptune Chain is a highly durable chain that offers superb saltwater, weather, chemical and comprehensive corrosion resistance.

It uses no harmful chromium, instead using revolutionary eco-friendly surface treatment technology.

*Note on usage: Contact a Tsubaki representative when using in high temperature steam environments.

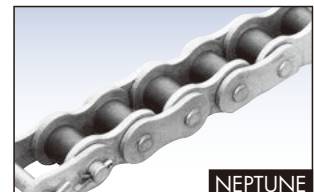
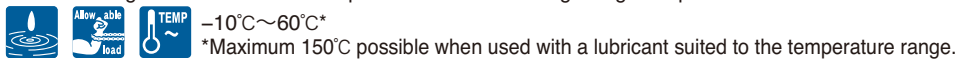

APP Series For protection against pitting corrosion fracture

Pins are treated with a non-strength degrading surface treatment to protect against pitting corrosion that leads to fatigue breakage, making it highly effective in environments that readily promote corrosion, such as outdoor or coastal applications.

Safety precautions when using Surface Treated Drive Chains

Do not use NP / NEP Series Surface Treated Drive Chains if the chains will come in direct contact with food or where coating flakes or wear dust can contaminate food. The specific gravity of flaked NEP film is lighter than water and will float.

Also, in non-food applications, either appropriately cover the chains or contact Tsubaki about chain selection if usage is planned in environments where coating flakes and wear dust present problems. Though nickel is not subject to the Food Sanitation Law or the Industrial Safety and Health Law, plating on sliding parts can flake.

Key



Titanium Roller Chains

Titanium chains are non-magnetic and offer high corrosion resistance. For details on corrosion resistance selection, see pg. 198.



TI

Cold Resistant Roller Chains (Specialty Roller Chain)

These chains can be used in lower temperatures than RS Roller Chains yet deliver the same allowable load (when using an F-type connecting link). Expect a 20% reduction in strength when using an M-type connecting link.

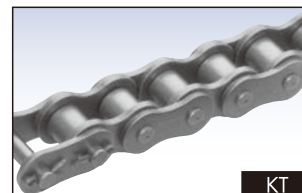

KT

Low Noise Roller Chains (Specialty Roller Chain)

These chains emit 6 to 8 dB less noise than pre-lubed RS Roller Chains (in-house comparison testing).

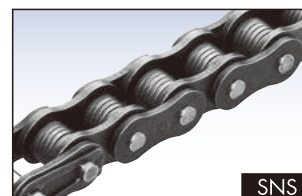
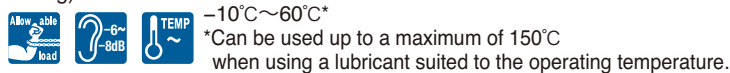

SNS

Poly Steel Chains

■ PC (Standard Series)

Clean, quiet running chain.

The pins and outer plates of these chains are made of 304 stainless steel (301 stainless steel clips), while the inner links are made of engineering plastic (white). They are lube-free, low noise (5 dB less than RS Roller Chains) and lightweight (50% of RS Roller Chains). They can be used in temperatures of -20 to 80°C. For details on corrosion resistance selection, see pg. 197.

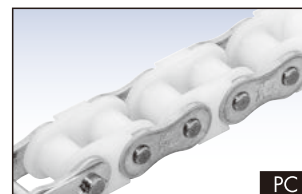

PC

■ PC-SY (Super Chemical Resistant Series)

Poly Steel Chain with superb chemical resistance.

The pins and outer plates of these chains are made of titanium, while the inner links are made of a special engineering plastic (matte white); therefore they are suited for applications in which PC Chains have insufficient corrosion resistance. They can be used in temperatures of -20 to 80°C. For details on corrosion resistance selection, see pg. 197. Bear in mind when making your selection that maximum allowable load is about 60% that of PC Chains.



PC-SY

■ BS-PC (BS Standard Series)

Poly Steel Chain that conforms to BS standards.

Curved Stainless Steel Roller Chains

These roller chains have a wide sideflex due to their original pin / bush construction and the large clearance between their plates. Curved power transmission is easy using RS-type standard sprockets.



CU-SS

⚠ Pre-Delivery Lubrication

- SS Series and NS Series Stainless Steel Roller Chains, Titanium Roller Chains, and Curved Stainless Steel Roller Chains are not lubricated before delivery. Always lubricate your chain before use, except when chains are to be used submerged in or in contact with water. If chains are not lubricated for use, then they may suffer articulation problems prematurely.
- The maximum allowable load is calculated under lubricated conditions (including water lubricant).

*RS11-SS-1, RS25-SS-1, and RS25-NS-1 chains are lubricated.

SS Series

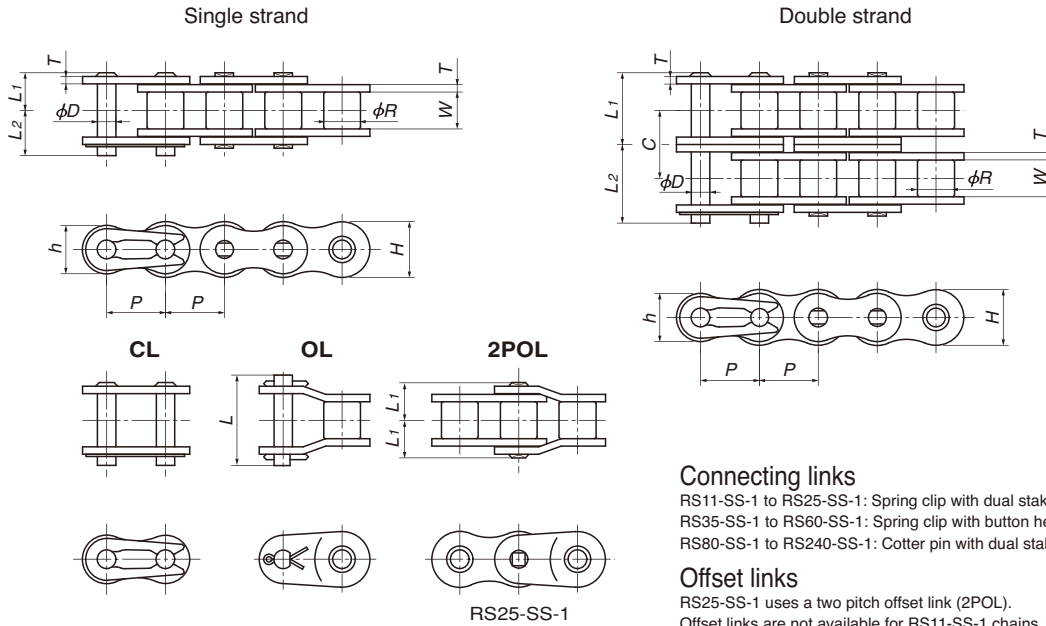

Connecting links

RS11-SS-1 to RS25-SS-1: Spring clip with dual stake riveting
 RS35-SS-1 to RS60-SS-1: Spring clip with button head riveting
 RS80-SS-1 to RS240-SS-1: Cotter pin with dual stake riveting

Offset links

RS25-SS-1 uses a two pitch offset link (2POL).
 Offset links are not available for RS11-SS-1 chains.

SS Series Stainless Steel Roller Chains are not lubricated before delivery. Always lubricate your chain before use, except when chains are to be used submerged in or in contact with water. If chains are not lubricated for use, then they may suffer articulation problems prematurely.
 The maximum allowable load is calculated under lubricated conditions (including water lubricant).
 *RS11-SS-1 and RS25-SS-1 chains are lubricated.

TSUBAKI Chain Number	Pitch P	Roller Diameter R	Inner Width of Inner Link W	Plates			Pins					Transverse Pitch C	Maximum Allowable Load kN {kgf}	Approximate Mass kg/m	Links Per Unit
				Thickness T	Height H	Height h	Diameter D	L1 + L2	L1	L2	Offset Pin Length L				
RS11-SS-1	3.7465	※2.285	1.83	0.38	3.5	3.5	1.57	5.44	2.275	3.165	—	—	0.05 {5}	0.052	134
RS25-SS-1	6.35	※3.30	3.18	0.75	5.84	5.05	2.31	8.6	3.8	4.8	—	—	0.12 {12}	0.14	160
RS35-SS-1	9.525	※5.08	4.78	1.25	9.0	7.8	3.59	12.9	6.05	6.85	14.7	—	0.26 {27}	0.33	320
RS40-SS-1	12.70	7.92	7.95	1.5	12.0	10.4	3.97	17.9	8.25	9.65	18.6	—	0.44 {45}	0.64	240
RS40-SS-2								32.6	15.25	17.35	33.5	14.4	0.88 {90}	1.27	
RS50-SS-1	15.875	10.16	9.53	2.0	15.0	13.0	5.09	22.3	10.3	12.0	23.9	—	0.69 {70}	1.04	192
RS50-SS-2								40.4	19.15	21.25	41.8	18.1	1.37 {140}	2.07	
RS60-SS-1	19.05	11.91	12.70	2.4	18.1	15.6	5.96	27.6	12.85	14.75	29.4	—	1.03 {105}	1.53	160
RS60-SS-2								50.4	24.25	26.15	52.6	22.8	2.06 {210}	3.04	
RS80-SS-1	25.40	15.88	15.88	3.2	24.1	20.8	7.94	35.7	16.25	19.45	39.0	—	1.77 {180}	2.66	120
RS80-SS-2								64.8	30.90	33.90	68.05	29.3	3.53 {360}	5.30	
RS100-SS-1	31.75	19.05	19.05	4.0	30.1	26.0	9.54	42.6	19.75	22.85	45.7	—	2.55 {260}	4.01	96
RS100-SS-2								78.5	37.70	40.80	81.6	35.8	5.10 {520}	7.99	
RS120-SS-1	38.10	22.23	25.40	5.0	36.2	31.2	11.11	55.55	25.75	29.80	59.7	—	3.82 {390}	6.13	80
RS120-SS-2								100.6	48.35	52.25	104.9	45.4	7.65 {780}	12.22	
RS140-SS-1	44.45	25.40	25.40	6.0	42.2	36.4	12.71	61.1	28.15	32.95	66.2	—	4.61 {470}	7.91	68
RS140-SS-2								110.0	52.70	57.30	114.6	48.9	9.22 {940}	15.77	
RS160-SS-1	50.80	28.58	31.75	7.0	48.2	41.6	14.29	72.1	33.55	38.55	77.3	—	6.37 {650}	10.86	60
RS160-SS-2				6.4				127.2	66.05	61.15	132.2	58.5	12.7 {1300}	21.66	
RS180-SS-1	57.15	35.71	35.72	7.15	54.2	46.8	17.46	78.1	35.65	42.45	84.9	—	8.55 {872}	13.45	54
RS200-SS-1	63.50	39.68	38.10	8.0	60.3	52.0	19.85	84.8	39.5	45.3	90.8	—	10.8 {1100}	16.54	48
RS240-SS-1	76.20	47.63	47.63	10.0	72.4	62.4	23.81	105.5	49.0	56.5	113.2	—	15.7 {1600}	24.50	40

- Note: 1. Chains marked with an * are rollerless - - bush diameter given.
 2. Multi-strand stainless steel chains and sprockets are made-to-order. Be aware that chain sizes greater than RS120-SS-1 have a different plate thickness than RS Roller Chains.
 3. Items in bold are stocked in units. All other items are made-to-order.
 4. The dimensions shown in this catalog are nominal dimensions and differ from actual dimensions.

Before Use Standard Roller Chains Lube-Free Roller Chains Heavy Duty Roller Chains Corrosion Resistant Roller Chains Specialty Roller Chains Sprockets Pin Gear Drives Accessories Handling

NS Series

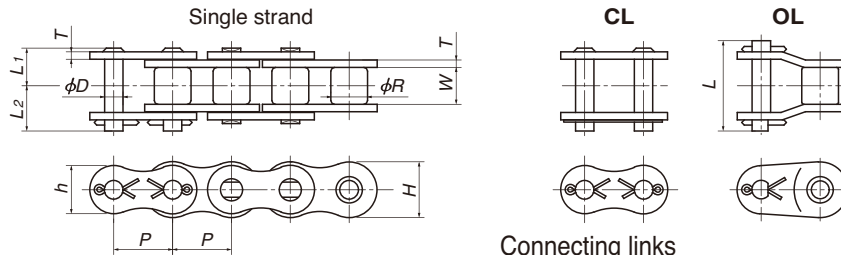

Connecting links

RS25-NS-1: Spring clip with quad stake riveting
 RS35-NS-1 to RS60-SS-1: Cotter pin (SUS316) with button head riveting
 RS80-NS-1: Cotter pin (SUS304) with dual riveting

NS Series Stainless Steel Roller Chains are not lubricated before delivery. Always lubricate your chain before use, except when chains are to be used submerged in or in contact with water. If chains are not lubricated for use, then they may suffer articulation problems prematurely.
 *RS25-NS-1 chain is lubricated.

TSUBAKI Chain Number	Pitch P	Roller Diameter R	Inner Width of Inner Link W	Plates			Pins					Maximum Allowable Load kN{kgf}	Approximate Mass kg/m	Links Per Unit
				Thickness T	Height H	Height h	Diameter D	L1 + L2	L1	L2	Offset Pin Length L			
RS25-NS-1	6.35	※3.30	3.18	0.75	5.84	5.05	2.31	8.3	3.8	4.5	(7.6)	0.12 {12}	0.14	160
RS35-NS-1	9.525	※5.08	4.78	1.25	9.0	7.8	3.59	13.0	5.85	7.15	14.7	0.26 {27}	0.33	320
RS40-NS-1	12.70	7.92	7.95	1.5	12.0	10.4	3.97	17.9	8.25	9.65	18.6	0.44 {45}	0.64	240
RS50-NS-1	15.875	10.16	9.53	2.0	15.0	13.0	5.09	22.2	10.3	11.9	23.9	0.69 {70}	1.04	192
RS60-NS-1	19.05	11.91	12.70	2.4	18.1	15.6	5.96	28.1	12.85	15.25	29.4	1.03{105}	1.53	160
RS80-NS-1	25.40	15.88	15.88	3.2	24.1	20.8	7.94	35.7	16.25	19.45	39.0	1.77{180}	2.66	120

- Note: 1. Chains marked with an ※ are rollerless - - bush diameter given..
 2. RS25-NS-1 uses only 2POL.
 3. Made-to-order product.
 4. The dimensions shown in this catalog are nominal dimensions and differ from actual dimensions.

AS Series

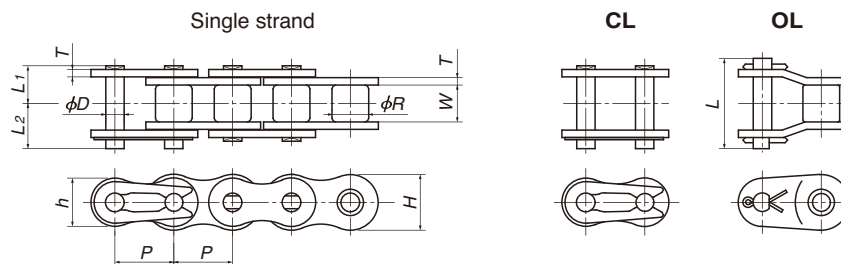

Connecting links

RS80-AS-1: Cotter pin

TSUBAKI Chain Number	Pitch P	Roller Diameter R	Inner Width of Inner Link W	Plates			Pins					Maximum Allowable Load kN{kgf}	Approximate Mass kg/m	Links Per Unit
				Thickness T	Height H	Height h	Diameter D	L1 + L2	L1	L2	Offset Pin Length L			
RS40-AS-1	12.70	7.92	7.95	1.5	12.0	10.4	3.97	18.2	8.25	9.95	18.6	0.69{70}	0.64	240
RS50-AS-1	15.875	10.16	9.53	2.0	15.0	13.0	5.09	22.3	10.3	12.0	23.9	1.03{105}	1.04	192
RS60-AS-1	19.05	11.91	12.70	2.4	18.1	15.6	5.96	27.6	12.85	14.75	29.4	1.57{160}	1.53	160
RS80-AS-1	25.40	15.88	15.88	3.2	24.1	20.8	7.94	35.7	16.25	19.45	39.0	2.65{270}	2.66	120

- Note: 1. Stocked in units.
 2. The dimensions shown in this catalog are nominal dimensions and differ from actual dimensions.

Before Use
 Standard Roller Chains
 Lubrication
 Lubrication
 Heavy Duty Roller Chains
 Corrosion Resistant Roller Chains
 Specialty Roller Chains
 Sprockets
 Pin Gear Drives
 Accessories
 Selection
 Handling

LSC Series Stainless Steel Drive Chain

Tsubaki's LSC Series Stainless Steel Drive Chain provides long life not only in dry environments, but also in contact with water or even underwater. Stainless steel chains are an ideal choice in production lines with a washdown process; in the food industry, where water is often part of the production process; in sanitary and pharmaceutical packaging industries; and in a wide variety of other industries.

Uses a special plastic sleeve for the bearing

Features black engineering plastic sleeves between SS Series stainless steel chain pins and bushes. Rollers can be either stainless steel or engineering plastic (white).

Material

Base chain: 18-8 stainless steel
(SUS 304 equivalent) for pins, bushes, and plates
Rollers: 18-8 stainless steel
(SUS 304 equivalent) or engineering plastic (white)
Sleeves: Engineering plastic (black)

Basic construction

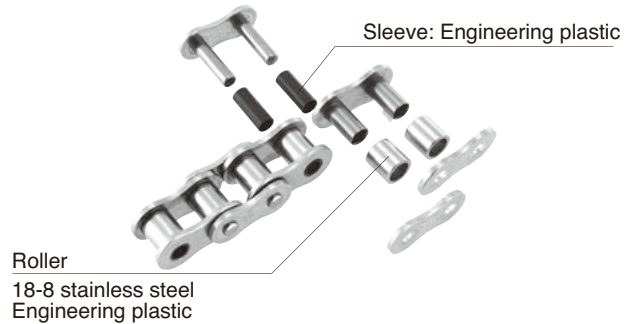

Features

Long life

..... Stainless steel rollers provide over four times the wear life of SS Series Stainless Steel Chain. Engineering plastic rollers provide over ten times the wear life.

Quiet and lightweight

..... 15% lighter
7-10dB quieter
*Comparison between LSC Chain with engineering plastic rollers and SS Series chain.

Clean

..... Ideal for equipment in situations where cleanliness is important.

Operating temperature range

..... -20°C to 100°C (with stainless steel rollers)
-20°C to 80°C (with engineering plastic rollers)

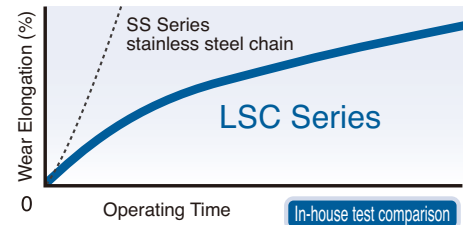

Wear life comparison with stainless steel chain (18-8 stainless steel, SUS304 equiv.)

Operating environment	Roller type	
	Stainless steel	Engineering plastic
Dry	Over 4x the wear life	Over 10x the wear life
In contact with water, underwater	Over 4x the wear life	—————

Engineering plastic rollers may suffer premature wear when in contact with water or underwater. Tsubaki (In-house test comparison) does not recommend their use in these environments.

⚠ Caution when disassembling or connecting LSC Series Chain

When disassembling the chain, be careful that the engineering plastic sleeves (black pipe) between the pins and bushes do not fall out. Also, ensure that the sleeves are present between the pins and bushes when connecting.

⚠ Clean regularly to remove any black dust that may appear.

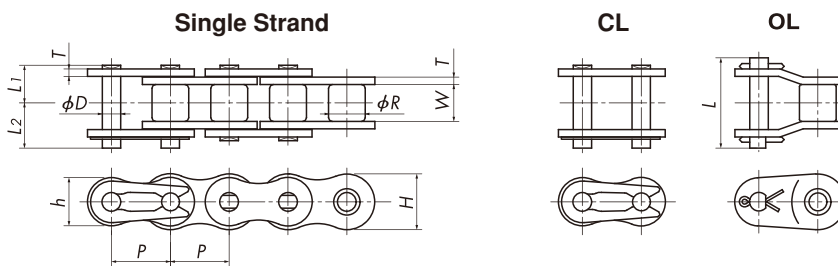

Connecting Link

RS40 – RS60 : Clip type
RS80 : Cotter pin type

TSUBAKI Chain Number		Pitch P	Roller Dia. R	Inner Link Inner Width W	Plate			Pin				
Stainless Steel Rollers	Engineering Plastic Rollers				T	H	h	D	L1+L2	L1	L2	Offset Pin Length L
RS40-LSC-1	RS40SP-LSC-1	12.70	7.92	7.95	1.5	12.0	10.4	3.97	18.2	8.25	9.95	18.6
RS50-LSC-1	RS50SP-LSC-1	15.875	10.16	9.53	2.0	15.0	13.0	5.09	22.3	10.3	12.0	23.9
RS60-LSC-1	RS60SP-LSC-1	19.05	11.91	12.70	2.4	18.1	15.6	5.96	27.6	12.85	14.75	29.4
RS80-LSC-1	RS80SP-LSC-1	25.40	15.88	15.88	3.2	24.1	20.8	7.94	35.5	16.25	19.25	39.0

TSUBAKI Chain Number		Maximum Allowable Load kN{kgf}		Approximate Mass kg/m		No. of Links per Unit
Stainless Steel Rollers	Engineering Plastic Rollers	Steel Rollers	Engineering Plastic Rollers	Steel Rollers	Engineering Plastic Rollers	
RS40-LSC-1	RS40SP-LSC-1	0.44{45}	0.23{23}	0.64	0.50	240
RS50-LSC-1	RS50SP-LSC-1	0.69{70}	0.34{35}	1.04	0.88	192
RS60-LSC-1	RS60SP-LSC-1	1.03{105}	0.54{55}	1.53	1.27	160
RS80-LSC-1	RS80SP-LSC-1	1.77{180}	—	2.66	—	120

Note: 1. Made-to-order product.
2. The dimensions shown in this catalog are nominal dimensions and differ from actual dimensions.

Before Use | Standard Roller Chains | Lubrication | Heavy Duty Roller Chains | Corrosion Resistant Roller Chains | Specialty Roller Chains | Sprockets | Pin Gear Drives | Accessories | Selection | Handling

NP Series

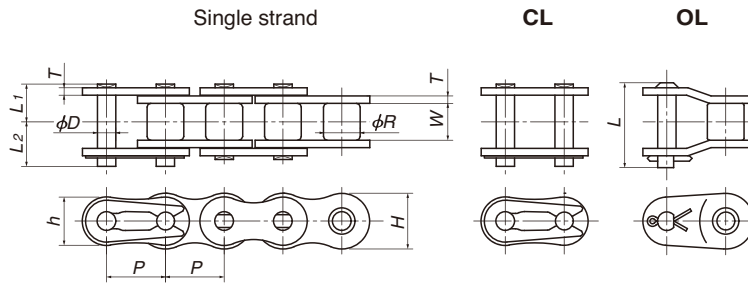

Connecting links

RS80-NP-1 to RS120-NP-1: Cotter pin (dual riveting)
 RS100-NP-1 and RS120-NP-1 both use cotter pins for the base chain connecting links.

Offset links

RS25-NP-1 uses a 2POL.

TSUBAKI Chain Number	Pitch P	Roller Diameter R	Inner Width of Inner Link W	Plates			Pins					Pin type
				Thickness T	Height H	Height h	Diameter D	L1 + L2	L1	L2	Offset Pin Length L	
RS25-NP-1	6.35	※ 3.30	3.18	0.75	5.84	5.05	2.31	8.3	3.8	4.5	7.6	Riveting
RS35-NP-1	9.525	※ 5.08	4.78	1.25	9.0	7.8	3.59	12.7	5.85	6.85	13.5	"
RS40-NP-1	12.70	7.92	7.95	1.5	12.0	10.4	3.97	18.2	8.25	9.95	18.0	"
RS50-NP-1	15.875	10.16	9.53	2.0	15.0	13.0	5.09	22.2	10.3	11.9	22.6	"
RS60-NP-1	19.05	11.91	12.70	2.4	18.1	15.6	5.96	27.6	12.85	14.75	28.2	"
RS80-NP-1	25.40	15.88	15.88	3.2	24.1	20.8	7.94	35.5	16.25	19.25	36.0	"
RS100-NP-1	31.75	19.05	19.05	4.0	30.1	26.0	9.54	42.6	19.75	22.85	44.4	Cotter pin
RS120-NP-1	38.10	22.23	25.40	4.8	36.2	31.2	11.11	53.8	24.9	28.9	45.4	"

TSUBAKI Chain Number	Minimum Tensile Strength kN{kgf}	Average Tensile Strength kN{kgf}	Maximum Allowable Load kN{kgf}	Approximate Mass kg/m	Number of Links Per Unit
RS25-NP-1	4.12 {420}	4.7 {480}	0.64 {65}	0.14	160
RS35-NP-1	9.81{1000}	11.3 {1150}	1.86 {190}	0.33	320
RS40-NP-1	17.7 {1800}	19.1 {1950}	3.04 {310}	0.64	240
RS50-NP-1	28.4 {2900}	31.4 {3200}	5.39 {550}	1.04	192
RS60-NP-1	40.2 {4100}	44.1 {4500}	7.26 {740}	1.53	160
RS80-NP-1	71.6 {7300}	78.5 {8000}	12.7 {1300}	2.66	120
RS100-NP-1	107 {10900}	118 {12000}	19.1 {1950}	3.99	96
RS120-NP-1	148 {15100}	167 {17000}	25.5 {2600}	5.93	80

- Note: 1. Chains marked with an * are rollerless – bush diameters given.
 2. Maximum allowable load when using a one pitch offset link (OL) is 65% of the above.
 3. Items in bold are stocked in units. All other items are made-to-order.
 4. Maximum allowable load when using an RS25-NP-1 M-type connecting link is 80% of the above.
 The minimum tensile strength for RS25-NP-1-2POL is 3.82kN.
 5. The dimensions shown in this catalog are nominal dimensions and differ from actual dimensions.

⚠ Precautions in Usage

- Do not use surface-treated drive chains if the chains will come in direct contact with food or where flaked coating can contaminate food.
- Though nickel is not subject to the Food Sanitation Law or Industrial Safety and Health Law, use with caution.

NEPTUNE CHAIN®

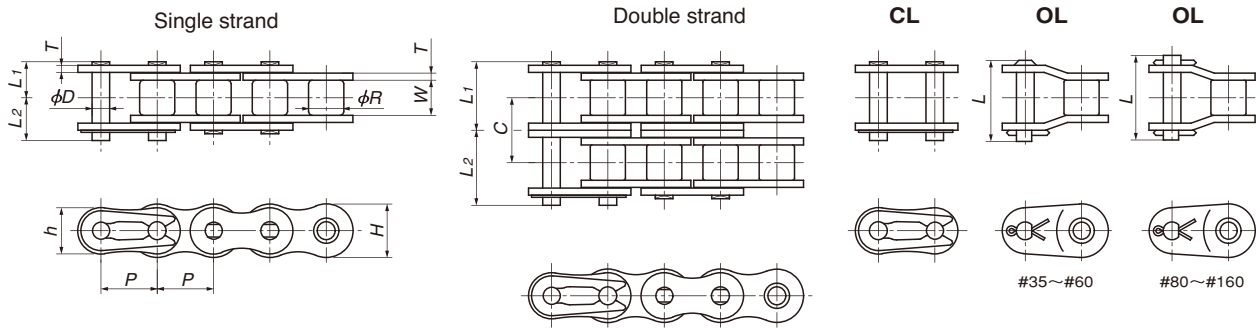

Connecting links

RS80 and above use cotter pins.
All sizes of Neptune Chain are riveted.

TSUBAKI Chain Number	Pitch P	Roller Diameter R	Inner Width of Inner Link W	Plates			Pins					Transverse Pitch C
				Thickness T	Height H	Height h	Diameter D	L1 + L2	L1	L2	Offset Pin Length L	
RS35-NEP-1	9.525	(5.08)*	4.78	1.25	9.0	7.8	3.59	12.7	5.85	6.85	13.5	—
RS40-NEP-1	12.70	7.92	7.95	1.5	12.0	10.4	3.97	18.2	8.25	9.95	18.2	—
RS40-NEP-2								32.6	15.45	17.15	33.5	14.4
RS50-NEP-1	15.875	10.16	9.53	2.0	15.0	13.0	5.09	22.2	10.3	11.9	22.6	—
RS50-NEP-2								40.5	19.35	21.15	41.8	18.1
RS60-NEP-1	19.05	11.91	12.70	2.4	18.1	15.6	5.96	27.6	12.85	14.75	28.2	—
RS60-NEP-2								50.5	24.25	26.25	52.6	22.8
RS80-NEP-1	25.40	15.88	15.88	3.2	24.1	20.8	7.94	35.5	16.25	19.25	38.2	—
RS80-NEP-2								64.8	30.9	33.9	67.5	29.3
RS100-NEP-1	31.75	19.05	19.05	4.0	30.1	26.0	9.54	42.6	19.75	22.85	45.7	—
RS100-NEP-2								78.5	37.7	40.8	81.5	35.8
RS120-NEP-1	38.10	22.23	25.40	4.8	36.2	31.2	11.11	53.8	24.9	28.9	57.8	—
RS140-NEP-1	44.45	25.40	25.40	5.6	42.2	36.4	12.71	58.6	26.9	31.7	63.4	—
RS160-NEP-1	50.80	28.58	31.75	6.4	48.2	41.6	14.29	68.7	31.85	36.85	73.6	—

TSUBAKI Chain Number	Minimum Tensile Strength kN {kgf}	Maximum Allowable Load kN {kgf}	Approximate Mass kg/m	Number of Links Per Unit
RS35-NEP-1	9.81 {1000}	2.16 {220}	0.33	320
RS40-NEP-1	17.7 {1800}	3.63 {370}	0.64	240
RS40-NEP-2	35.3 {3600}	6.18 {630}	1.27	
RS50-NEP-1	28.4 {2900}	6.37 {650}	1.04	192
RS50-NEP-2	56.9 {5800}	10.8 {1100}	2.07	
RS60-NEP-1	40.2 {4100}	8.83 {900}	1.53	160
RS60-NEP-2	80.4 {8200}	15.0 {1530}	3.04	
RS80-NEP-1	71.6 {7300}	14.7 {1500}	2.66	120
RS80-NEP-2	143 {14600}	25.0 {2550}	5.27	
RS100-NEP-1	107 {10900}	22.6 {2300}	3.99	96
RS100-NEP-2	214 {21800}	38.3 {3910}	7.85	
RS120-NEP-1	148 {15100}	30.4 {3100}	5.93	80
RS140-NEP-1	193 {19700}	40.2 {4100}	7.49	68
RS160-NEP-1	255 {26000}	53.0 {5400}	10.10	60

Note: 1. Maximum allowable load when using a one-pitch offset link (OL) is 65% of the above.

The shape of offset link pins will vary by size.

- "*" indicates it is a bushed chain; it does not have rollers.
- Multi-strand RS35-NEP is not available.
- Items in bold are stocked in units. All other items are made-to-order.
- Please contact a Tsubaki representative for information regarding 2POL and RS180 and above chains.
- The dimensions shown in this catalog are nominal dimensions and differ from actual dimensions.

Precautions on Usage: Depending on the usage conditions, if steel roller chains are used with stainless steel sprockets, the rollers may prematurely wear due to galvanic corrosion. Please avoid this set up as much as possible. Compared to single strand chain, the middle link of multi-strand chain is slightly less corrosion resistant (based on in-house testing).

APP Series

Outstanding performance in atmospheres conducive to pitting corrosion

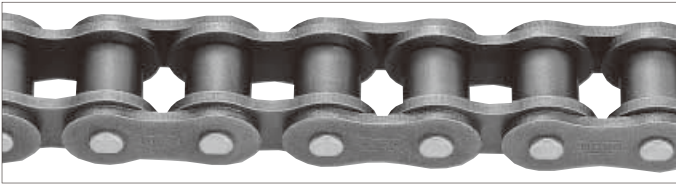

Pins are treated with a special surface treatment to protect against pitting corrosion that leads to fatigue breakage, thus preventing strength loss. This treatment is highly effective in environments that readily promote corrosion, such as outdoors or in coastal applications.

Note: Pitting is a type of localized corrosion affecting metal surfaces. Pits form toward the interior, and if pitting occurs on pin surfaces, that pin can quickly lead to fatigue breakage and chain failure.

■ Features

① **No strength loss!**

Same as standard steel chain.

② **Eco-friendly chrome-free!**

Special surface treatment does not use hazardous hexavalent chromium.

■ Example applications

APP Chains are ideal for atmospheres that readily promote corrosion.

■ Outdoor uses

■ Coastal or riverside uses

■ When regular lubrication is difficult

● Bucket elevators

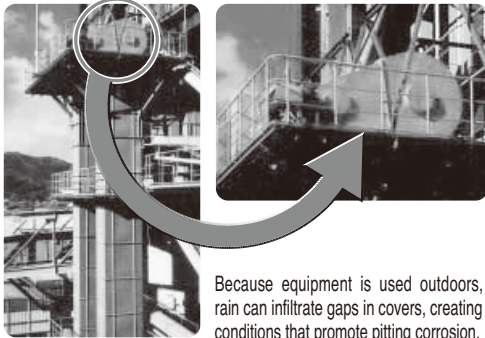

Because equipment is used outdoors, rain can infiltrate gaps in covers, creating conditions that promote pitting corrosion.

● Transfer cranes and other port machinery

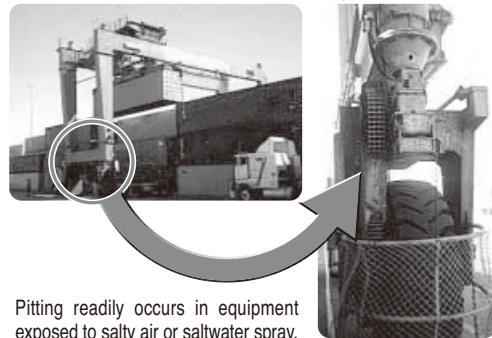

Pitting readily occurs in equipment exposed to salty air or saltwater spray.

■ Examples of fatigue breakage caused by pitting corrosion

Chain: RS240 Equipment: Port container carrier

Pitting corrosion of the pin due to insufficient lubrication (effects of salty air and saltwater) and corrosive atmosphere - - Fatigue breakage

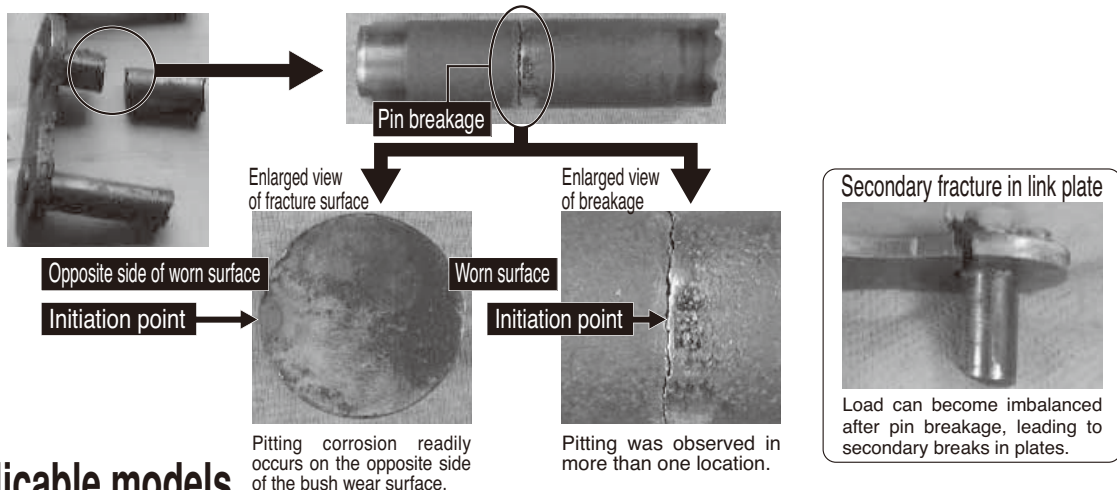

■ Applicable models

■ Single/Double Strand RS Roller Chain

■ Single Strand Heavy Duty Roller Chain

(For other models, contact a Tsubaki representative.)

Except for the surface-treated pins, dimensions and other specifications are the same as other roller chains.

■ Chain number

RS80-APP-1

RS80-SUP-APP-1-F or M

RS80-HT-APP-1-F or M

Note: Select connecting link (CL).

Anti-Pitting Roller Chain

Before Use Standard Roller Chains Lubrication-Free Roller Chains Heavy Duty Roller Chains Corrosion Resistant Roller Chains Specialty Roller Chains Sprockets Pin Gear Drives Accessories Selection Handling

Titanium Roller Chains

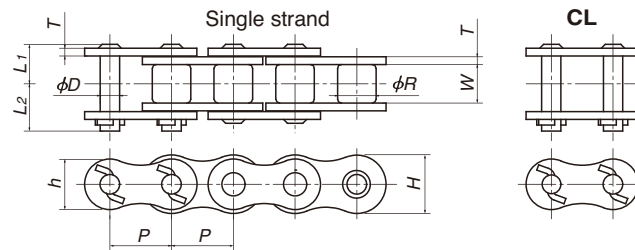

Titanium Roller Chains are not lubricated before delivery. Always lubricate your chain before use, except when chains are to be used submerged in or in contact with water. If chains are not lubricated for use, then they may suffer articulation problems prematurely.

Model	Pitch P	Roller Diameter R	Inner Width of Inner Link W	Plates			Pins				Maximum Allowable Load kN {kgf}	Approximate Mass kg/m	Links Per Unit
				Thickness T	Height H	Height h	Diameter D	$L_1 + L_2$	L_1	L_2			
RS35-TI-1	9.525	※5.08	4.78	1.25	9.0	7.8	3.59	13.2	6.05	7.15	0.26{27}	0.19	320
RS40-TI-1	12.70	7.92	7.95	1.5	12.0	10.4	3.97	18.35	8.25	10.1	0.44{45}	0.37	240

Note: 1. The figure shown is the bush diameter.

2. Connecting links (CL) use Z-pins.

3. Offset links are not available.

4. Made-to-order product.

5. The dimensions shown in this catalog are nominal dimensions and differ from actual dimensions.

Cold Resistant Roller Chains

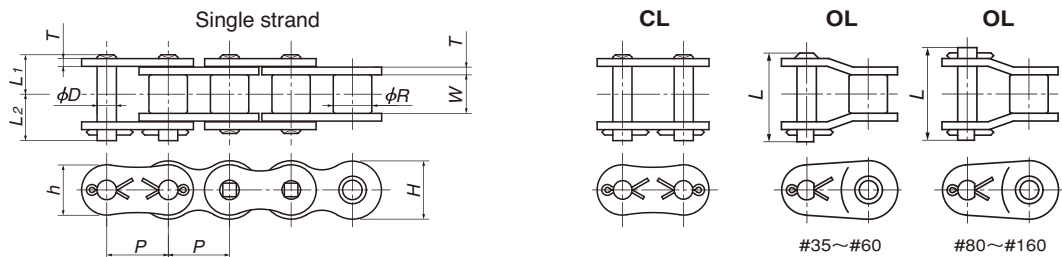

Model	Pitch P	Roller Diameter R	Inner Width of Inner Link W	Plates			Pins				
				Thickness T	Height H	Height h	Diameter D	$L_1 + L_2$	L_1	L_2	Offset Pin Length l
RS35-KT-1	9.525	※5.08	4.78	1.25	9.0	7.8	3.59	12.9	5.85	7.05	13.5
RS40-KT-1	12.70	7.92	7.95	1.5	12.0	10.4	3.97	17.9	8.25	9.65	18.0
RS50-KT-1	15.875	10.16	9.53	2.0	15.0	13.0	5.09	22.2	10.3	11.9	22.6
RS60-KT-1	19.05	11.91	12.70	2.4	18.1	15.6	5.96	28.1	12.85	15.25	28.2
RS80-KT-1	25.40	15.88	15.88	3.2	24.1	20.8	7.94	35.5	16.25	19.25	36.6
RS100-KT-1	31.75	19.05	19.05	4.0	30.1	26.0	9.54	42.6	19.75	22.85	43.7
RS120-KT-1	38.10	22.23	25.40	4.8	36.2	31.2	11.11	53.8	24.9	28.9	55.0
RS140-KT-1	44.45	25.40	25.40	5.6	42.2	36.4	12.71	58.6	26.9	31.7	62.8
RS160-KT-1	50.80	28.58	31.75	6.4	48.2	41.6	14.29	68.7	31.85	36.85	70.2

Model	Minimum Tensile Strength kN {kgf}	Average Tensile Strength kN {kgf}	Maximum Allowable Load kN {kgf}	Approximate Mass kg/m	Number of Links Per Unit
RS35-KT-1	9.81{1000}	11.3{1150}	2.16{220}	0.33	320
RS40-KT-1	17.7 {1800}	19.1{1950}	3.63{370}	0.64	240
RS50-KT-1	28.4 {2900}	31.4{3200}	6.37{650}	1.04	192
RS60-KT-1	40.2 {4100}	44.1{4500}	8.83{900}	1.53	160
RS80-KT-1	71.6 {7300}	78.5{8000}	14.7{1500}	2.66	120
RS100-KT-1	107 {10900}	118 {12000}	22.6{2300}	3.99	96
RS120-KT-1	148 {15100}	167 {17000}	30.4{3100}	5.93	80
RS140-KT-1	193 {19700}	216 {22000}	40.2{4100}	7.49	68
RS160-KT-1	255 {26000}	279 {28500}	53.0{5400}	10.10	60

Note: 1. Values marked with * are rollerless.

2. Offset pin shape varies according to size.

3. Maximum allowable load when using MCL is 80% of the above values.

4. Maximum allowable load when using 1-pitch offset links (OL) is 65% of the above values.

5. Normally, chains are coated only with anti-rust oil when shipped. Chain should be lubricated with an oil suitable to the ambient temperature during actual use. Customized models that are coated with a silicone (low temperature) oil are also available.

6. Made-to-order product.

7. The dimensions shown in this catalog are nominal dimensions and differ from actual dimensions.

Corrosion Resistant Roller Chains

Low Noise Roller Chain

Low Noise Roller Chains

Tsubaki's uniquely structured spring rollers are used for the chain rollers. When Tsubaki's Low Noise Roller Chain engages the sprocket, the spring roller deforms and absorbs the force of impact, reducing impact noise between chain and sprocket for lower noise levels. Compared with Tsubaki's standard RS Roller Chain (pre-lubricated), noise levels of Low Noise Roller Chain are 6 - 8 dB lower. (In-house comparison testing)

Benefits of noise reduction

- Less factory noise for a better work environment.
- A low noise function is added to machinery and equipment used for manufacturing, and contributes to upgrading and improving their overall image.
- Belts were considered as a countermeasure for noise; however, there are many limitations in terms of application, strength and overall cost. Low Noise Chain is the perfect countermeasure.
- Recommended for applications where silence is a major concern, such as stage lifts used in theaters.

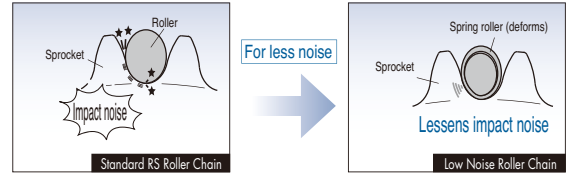

Features

Low noise

Noise levels reduced by 6 dB to 8 dB compared with the RS Roller Chain.

Interchangeability

Dimensional specifications are the same as for RS Roller Chain.

Note: There are limits on drive power; check kW ratings tables on pg. 93.

Selection

Use the General Selection Method (the kilowatt ratings tables on pg. 93). See selection pages for more details.

Operating temperatures

-10°C to 60°C

Allowable chain speed

200 m / min (max.)

Sprocket

Can be used with standard RS sprockets.

If the chain cannot be sufficiently lubricated, choose sprockets with hardened teeth specifications.

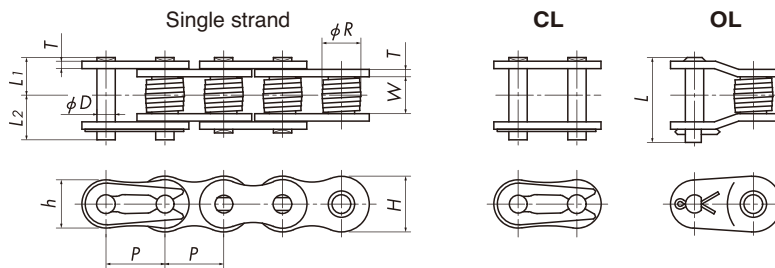
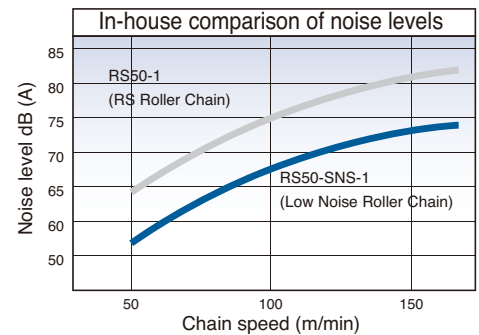

Connecting links

RS80 and above use cotter pins.

TSUBAKI Chain Number	Pitch <i>P</i>	Roller Diameter <i>R</i>	Inner Width of Inner Link <i>W</i>	Plates			Pins					
				Thickness <i>T</i>	Height <i>H</i>	Height <i>h</i>	Diameter <i>D</i>	<i>L</i> ₁ + <i>L</i> ₂	<i>L</i> ₁	<i>L</i> ₂	<i>L</i>	
RS40-SNS-1	12.70	8.5	7.95	1.5	12.0	10.4	3.97	18.2	8.25	9.95	18.0	
RS50-SNS-1	15.875	10.8	9.53	2.0	15.0	13.0	5.09	22.3	10.3	12.0	22.5	
RS60-SNS-1	19.05	12.6	12.70	2.4	18.1	15.6	5.96	27.6	12.85	14.75	28.2	
RS80-SNS-1	25.40	16.8	15.88	3.2	24.1	20.8	7.94	35.5	16.25	19.25	36.0	

TSUBAKI Chain Number	Minimum Tensile Strength kN{kgf}	Average Tensile Strength kN{kgf}	Maximum Allowable Load kN{kgf}	Approximate Mass kg/m	Number of Links Per Unit
RS40-SNS-1	17.7{1800}	19.1{1950}	3.63{370}	0.64	240
RS50-SNS-1	28.4{2900}	31.4{3200}	6.37{650}	1.04	192
RS60-SNS-1	40.2{4100}	44.1{4500}	8.83{900}	1.53	160
RS80-SNS-1	71.6{7300}	78.5{8000}	14.7 {1500}	2.66	120

Note: 1. Maximum allowable load when using 1-pitch offset links (OL) is 65% of the above values.

2. Stocked item.

3. Uses the same connecting link (CL) as RS Roller Chain.

4. The dimensions shown in this catalog are nominal dimensions and differ from actual dimensions.

Offset Links (OL)

Product Code	Chain Number
A146043	RS40-SNS-1-OL
A146044	RS50-SNS-1-OL
A146045	RS60-SNS-1-OL
A146046	RS80-SNS-1-OL

Kilowatt Ratings Tables (RS40-SNS-1~RS80-SNS-1)

Before Use
 Standard Roller Chains
 Lube-Free Roller Chains
 Heavy Duty Roller Chains
 Corrosion Resistant Roller Chains
 Specialty Roller Chains
 Sprockets
 Pin Gear Drives
 Accessories
 Selection
 Handling

■ RS40-SNS-1 Maximum Kilowatt Ratings Table (kW Ratings for Single Strand Chain)

Lubrication Type Small Sprocket No. of Teeth	Small Sprocket Max rpm														
	10	25	50	100	200	300	400	500	700	900	1000	1200	1400	1600	
	Oiled or with drip-oiling system								Oil bath						
9	0.05	0.11	0.21	0.39	0.72	1.04	1.35	1.64	1.06	0.73	0.62	0.47	0.38	0.31	
10	0.05	0.12	0.23	0.43	0.81	1.16	1.51	1.84	1.25	0.85	0.73	0.55	0.44		
11	0.06	0.14	0.26	0.48	0.90	1.29	1.67	2.04	1.44	0.99	0.84	0.64	0.51		
12	0.07	0.15	0.28	0.53	0.98	1.42	1.84	2.24	1.64	1.12	0.96	0.73			
13	0.07	0.17	0.31	0.57	1.07	1.54	2.00	2.45	1.85	1.27	1.08	0.82			
14	0.08	0.18	0.33	0.62	1.16	1.67	2.17	2.65	2.06	1.42	1.21				
15	0.08	0.19	0.36	0.67	1.25	1.80	2.34	2.86	2.29	1.57	1.34				
16	0.09	0.21	0.39	0.72	1.34	1.93	2.50	3.06	2.52	1.73					
17	0.10	0.22	0.41	0.77	1.43	2.06	2.67	3.27	2.76	1.89					
18	0.10	0.23	0.44	0.82	1.52	2.20	2.84	3.48	3.01						
19	0.11	0.25	0.46	0.87	1.62	2.33	3.02	3.69	3.26						
20	0.12	0.26	0.49	0.92	1.71	2.46	3.19	3.90	3.52						
21	0.12	0.28	0.52	0.96	1.80	2.59	3.36	4.11	3.79						
22	0.13	0.29	0.54	1.01	1.89	2.73	3.53	4.32	4.06						
23	0.13	0.31	0.57	1.06	1.99	2.86	3.71	4.53							
24	0.14	0.32	0.60	1.11	2.08	3.00	3.88	4.74							
25	0.15	0.33	0.62	1.16	2.17	3.13	4.06	4.96							
26	0.15	0.35	0.65	1.21	2.27	3.27	4.23	5.17							
28	0.17	0.38	0.71	1.32	2.46	3.54	4.58	5.60							
30	0.18	0.41	0.76	1.42	2.65	3.81	4.94	6.04							
32	0.19	0.44	0.81	1.52	2.84	4.09	5.29								
35	0.21	0.48	0.90	1.67	3.13	4.50	5.83								
40	0.24	0.56	1.04	1.93	3.61	5.20									
45	0.28	0.63	1.18	2.20	4.10	5.91									

■ RS50-SNS-1 Maximum Kilowatt Ratings Table (kW Ratings for Single Strand Chain)

Lubrication Type Small Sprocket No. of Teeth	Small Sprocket Max rpm											
	10	25	50	100	200	300	400	500	700	900	1000	1200
	Oiled or with drip-oiling system								Oil bath			
9	0.10	0.23	0.43	0.80	1.49	2.15	2.78	2.11	1.27	0.87	0.74	0.57
10	0.11	0.26	0.48	0.90	1.67	2.41	3.12	2.47	1.49	1.02	0.87	0.66
11	0.12	0.28	0.53	0.99	1.85	2.67	3.46	2.85	1.72	1.18	1.01	
12	0.14	0.31	0.58	1.09	2.03	2.93	3.80	3.24	1.96	1.34	1.15	
13	0.15	0.34	0.64	1.19	2.22	3.19	4.14	3.66	2.21	1.51		
14	0.16	0.37	0.69	1.29	2.40	3.46	4.48	4.09	2.47			
15	0.17	0.40	0.74	1.39	2.59	3.73	4.83	4.53	2.74			
16	0.19	0.43	0.80	1.49	2.78	4.00	5.18	4.99	3.01			
17	0.20	0.46	0.85	1.59	2.96	4.27	5.53	5.47	3.30			
18	0.21	0.49	0.91	1.69	3.15	4.54	5.88	5.96				
19	0.23	0.51	0.96	1.79	3.34	4.81	6.24	6.46				
20	0.24	0.54	1.01	1.89	3.53	5.09	6.59	6.98				
21	0.25	0.57	1.07	2.00	3.72	5.36	6.95	7.51				
22	0.26	0.60	1.12	2.10	3.91	5.64	7.31	8.05				
23	0.28	0.63	1.18	2.20	4.11	5.92	7.66	8.60				
24	0.29	0.66	1.24	2.30	4.30	6.19	8.03	9.17				
25	0.30	0.69	1.29	2.41	4.49	6.47	8.39	9.75				
26	0.32	0.72	1.35	2.51	4.69	6.75	8.75					
28	0.34	0.78	1.46	2.72	5.08	7.32	9.48					
30	0.37	0.84	1.57	2.93	5.47	7.88	10.2					
32	0.40	0.90	1.69	3.14	5.87	8.45						
35	0.44	0.99	1.86	3.46	6.46	9.31						
40	0.50	1.15	2.14	4.00	7.47	10.8						
45	0.57	1.30	2.44	4.54	8.48							

■ RS60-SNS-1 Maximum Kilowatt Ratings Table (kW Ratings for Single Strand Chain)

Lubrication Type Small Sprocket No. of Teeth	Small Sprocket Max rpm														
	10	25	50	100	150	200	300	400	500	600	700	800	900	1000	1100
	Oiled or with drip-oiling system								Oil bath						
9	0.18	0.41	0.76	1.41	2.03	2.63	3.79	3.41	2.44	1.85	1.47	1.20	1.01	0.86	0.75
10	0.20	0.45	0.85	1.58	2.28	2.59	4.25	3.99	2.85	2.17	1.72	1.41	1.18	1.01	
11	0.22	0.50	0.94	1.75	2.53	3.27	4.71	4.60	3.29	2.50	1.99	1.63	1.36		
12	0.24	0.55	1.03	1.93	2.77	3.59	5.18	5.24	3.79	2.85	2.26	1.85			
13	0.26	0.60	1.13	2.10	3.03	3.92	5.65	5.91	4.23	3.22	2.55	2.09			
14	0.29	0.65	1.22	2.28	3.28	4.25	6.12	6.61	4.73	3.60	2.85				
15	0.31	0.70	1.31	2.45	3.53	4.57	6.59	7.33	5.24	3.99					
16	0.33	0.75	1.41	2.63	3.79	4.90	7.06	8.07	5.78	4.39					
17	0.35	0.81	1.50	2.81	4.04	5.24	7.54	8.84	6.33	4.81					
18	0.38	0.86	1.60	2.98	4.30	5.57	8.02	9.63	6.89						
19	0.40	0.91	1.70	3.16	4.56	5.90	8.51	10.4	7.47						
20	0.42	0.96	1.79	3.34	4.82	6.24	8.99	11.3	8.07						
21	0.44	1.01	1.89	3.53	5.08	6.58	9.48	12.1							
22	0.47	1.06	1.99	3.71	5.34	6.92	9.96	12.9							
23	0.49	1.12	2.08	3.89	5.60	7.26	10.5	13.5							
24	0.51	1.17	2.18	4.07	5.87	7.60	10.9	14.2							
25	0.54	1.22	2.28	4.26	6.13	7.94	11.4	14.8							
26	0.56	1.28	2.38	4.44	6.40	8.29	11.9	15.5							
28	0.61	1.38	2.58	4.81	6.93	8.98	12.9								
30	0.65	1.49	2.78	5.18	7.46	9.67	13.9								
32	0.70	1.60	2.98	5.56	8.00	10.4	14.9								
35	0.77	1.76	3.28	6.12	8.82	11.4									
40	0.89	2.03	3.79	7.07	10.2	13.2									
45	1.01	2.31	4.30	8.03	11.6	15.0									

■ RS80-SNS-1 Maximum Kilowatt Ratings Table (kW Ratings for Single Strand Chain)

Lubrication Type Small Sprocket No. of Teeth	Small Sprocket Max rpm											
	10	25	50	100	150	200	300	400	500	600	700	800
	Oiled or with drip-oiling system								Oil bath			
9	0.40	0.91	1.69	3.16	4.55	5.90	6.60	4.29	3.07	2.33	1.85	1.52
10	0.45	1.02	1.90	3.54	5.10	6.61	7.73	5.02	3.59	2.73	2.17	
11	0.49	1.13	2.10	3.93	5.65	7.33	8.92	5.79	4.14	3.15	2.50	
12	0.54	1.24	2.31	4.31	6.21	8.05	10.2	6.60	4.72	3.59		
13	0.59	1.35	2.52	4.70	6.77	8.77	11.5	7.44	5.33	4.05		
14	0.64	1.46	2.73	5.09	7.34	9.51	12.8	8.32	5.95			
15	0.69	1.58	2.94	5.49	7.90	10.2	14.2	9.22	6.60			
16	0.74	1.69	3.15	5.88	8.48	11.0	15.6	10.2				
17	0.79	1.80	3.37	6.28	9.05	11.7	16.9	11.1				
18	0.84	1.92	3.58	6.68	9.63	12.5	18.0	12.1				
19	0.89	2.03	3.80	7.08	10.2	13.2	19.0	13.1				
20	0.94	2.15	4.01	7.49	10.8	14.0	20.1					
21	0.99	2.27	4.23	7.89	11.4	14.7	21.2					
22	1.04	2.38	4.45	8.30	12.0	15.5	22.3					
23	1.10	2.50	4.67	8.71	12.5	16.2	23.4					
24	1.15	2.62	4.89	9.12	13.1	17.0	24.5					
25	1.20	2.74	5.11	9.53	13.7	17.8	25.6					
26	1.25	2.85	5.33	9.94	14.3	18.5	26.7					
28	1.36	3.09	5.77	10.8	15.5	20.1						
30	1.46	3.33	6.22	11.6	16.7	21.6						
32	1.57	3.57	6.67	12.4	17.9	23.2						
35	1.73	3.94	7.34	13.7	19.7	25.6						
40	1.99	4.55	8.48	15.8	22.8							
45	2.26	5.16	9.63	18.0	25.9							

Note: With a one-pitch offset link kW ratings are 80% of that shown above.

Poly Steel Chains

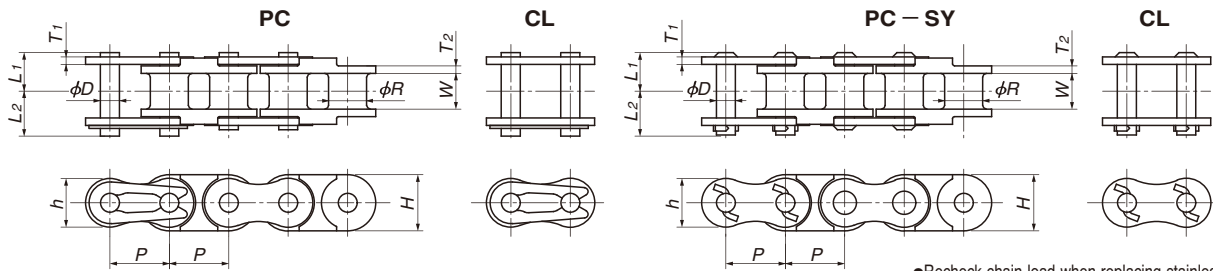

- Recheck chain load when replacing stainless steel chain with Poly Steel Chain.
- No offset links available.
- Base chain pin heads are not riveted.
- RS25 connecting links are riveted, RS35 connecting links are not riveted, and RS40 – RS60 connecting links use button head rivets.

PC Specification

TSUBAKI Chain Number	Pitch P	Bush Diameter R	Inner Width of Inner Link W	Plates				Pins				Maximum Allowable Load $kN\{kgf\}$	Approximate Mass kg/m	Links Per Unit
				Thickness T_1	Thickness T_2	Height H	Height h	Diameter D	$L_1 + L_2$	L_1	L_2			
RS25-PC-1	6.35	3.30	3.18	0.75	1.3	6.0	5.05	2.31	10.0	4.5	5.5	0.08 {8}	0.095	160
RS35-PC-1	9.525	5.08	4.78	1.25	2.2	9.0	7.8	3.59	14.7	6.85	7.85	0.18 {18}	0.22	320
RS40-PC-1	12.70	7.92	7.95	1.5	1.5	12.0	10.4	3.97	18.2	8.25	9.95	0.44 {45}	0.39	240
RS50-PC-1	15.875	10.16	9.53	2.0	2.0	15.0	13.0	5.09	22.3	10.3	12.0	0.69 {70}	0.58	192
RS60-PC-1	19.05	11.91	12.70	2.4	2.4	18.1	15.6	5.96	27.6	12.85	14.75	0.88 {90}	0.82	160

PC-SY Specification

TSUBAKI Chain Number	Pitch P	Bush Diameter R	Inner Width of Inner Link W	Plates				Pins				Maximum Allowable Load $kN\{kgf\}$	Approximate Mass kg/m	Links Per Unit
				Thickness T_1	Thickness T_2	Height H	Height h	Diameter D	$L_1 + L_2$	L_1	L_2			
RS40-PC-SY-1	12.70	7.92	7.95	1.5	1.5	12.0	10.4	3.97	18.35	8.25	10.1	0.25 {25}	0.39	240
RS50-PC-SY-1	15.875	10.16	9.53	2.0	2.0	15.0	13.0	5.09	22.3	10.3	12.0	0.39 {40}	0.58	192
RS60-PC-SY-1	19.05	11.91	12.70	2.4	2.4	18.1	15.6	5.96	28.1	12.85	15.25	0.49 {50}	0.82	160

Note: 1. Items in bold are stocked in units. All other items are made-to-order. PC-SY Series uses button head rivets for the base chain.
 2. The dimensions shown in this catalog are nominal dimensions and differ from actual dimensions.

Curved Stainless Steel Roller Chain

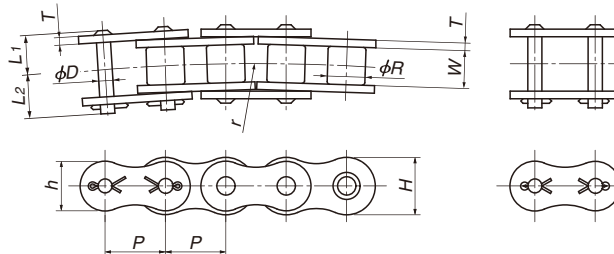

Curved Stainless Steel Roller Chains are not lubricated before delivery. Always lubricate your chain before use, except when chains are to be used submerged in or in contact with water. If chains are not lubricated for use, then they may suffer articulation problems prematurely.

Stainless steel (18-8SUS) specifications

Model	Pitch P	Roller Diameter R	Inner Width of Inner Link W	Plates			Pins			Min. Radius r	Maximum Allowable Load $kN\{kgf\}$	Approximate Mass kg/m	Links Per Unit	
				Thickness T	Height H	Height h	Diameter D	$L_1 + L_2$	L_1					L_2
RS40-CU-SS-1	12.70	7.92	7.95	1.5	12.0	10.4	3.59	18.1	8.35	9.75	400	0.26 {27}	0.61	240
RS50-CU-SS-1	15.875	10.16	9.53	2.0	15.0	13.0	3.97	22.2	10.15	12.05	500	0.44 {45}	1.01	192
RS60-CU-SS-1	19.05	11.91	12.70	2.4	18.1	15.6	5.09	28.3	13.25	15.05	600	0.69 {70}	1.40	160
RS80-CU-SS-1	25.40	15.88	15.88	3.2	24.1	20.8	5.96	35.0	16.5	18.5	800	1.03 {105}	2.47	120

Note: The dimensions shown in this catalog are nominal dimensions and differ from actual dimensions.

Operating temperature range : -20°C to 400°C

Made-to-order

Sprockets : Can use RS sprockets

- Attachment chains are available.
- See pg. 201 4.6 for information on installation.

Specialty Roller Chains

RS Curved Chain

A roller chain that can make large lateral curves thanks to its special pin and bush construction and the large clearance between link plates. Allows for easy curved transmission using RS sprockets. Ideal for curved conveyors and drives on curved roller conveyors.

*A guide is needed in the curved sections.

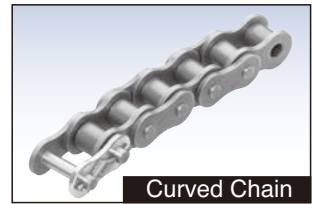

Curved Chain

Leaf Chain

Leaf Chain is a steel chain composed of just plates and pins. This chain is mainly used for lifting, counterweights, and motion drives. There are two types of Leaf Chains: AL type for light loads and BL type for heavy loads. Their dimensions and plate lacings differ.

*Requires special clevises and sheaves.

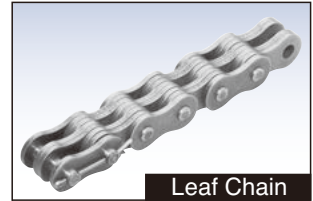

Leaf Chain

Specialty Roller Chains

Curved Roller Chain

Single strand

CL

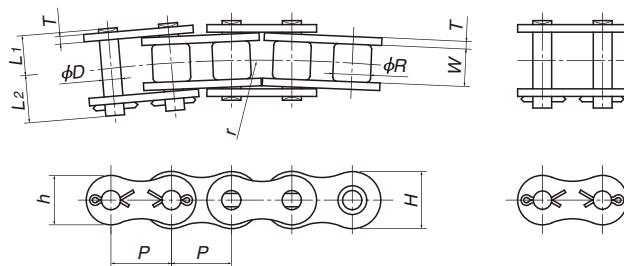

TSUBAKI Chain Number	Pitch P	Roller Diameter R	Inner Width of Inner Link W	Plates			Pins				Tightest lateral bend diameter r	Average Tensile Strength kN {kgf}	Maximum Allowable Load kN {kgf}	Approximate Mass kg/m	Number of Links Per Unit
				Thickness T	Height H	Height h	Diameter D	L1 + L2	L1	L2					
RS40-CU-1	12.70	7.92	7.95	1.5	12.0	10.4	3.97	18.2	8.45	9.75	350	15.5 {1580}	1.86 {190}	0.61	240
RS50-CU-1	15.875	10.16	9.53	2.0	15.0	13.0	5.09	23.0	10.6	12.4	400	24.1 {2460}	2.84 {290}	1.01	192
RS60-CU-1	19.05	11.91	12.70	2.4	18.1	15.6	5.96	28.3	13.25	15.05	500	34.9 {3560}	4.02 {410}	1.40	160
RS80-CU-1	25.40	15.88	15.88	3.2	24.1	20.8	7.94	36.8	16.75	20.05	600	61.6 {6280}	6.96 {710}	2.47	120

Note: 1. Stocked item.

2. The dimensions shown in this catalog are nominal dimensions and differ from actual dimensions.

Operating temperature range : -10°C to 60°C

Sprockets : Can use RS sprockets

- Attachment chains are available.
- See pg. 204 4.6 for information on installation.

Leaf Chains

Construction

Leaf chains are also commonly called balance chains. The most basic type of steel chain, they consist of just plates and pins. Conforming to JIS specifications and suitable for use in low-speed equipment, leaf chains are mainly used for lifting, counterweights, and motion drives.

The plates are connected by pins and take the strain when load is applied. Pins are press fitted to outer plates and riveted. However, a slip fit* is used with middle and inner plates and pins.

The pins pass between the plates and have to withstand the bulk of the shear forces resulting when the chain is under tension and move freely within the inner plate holes when the chain articulates.

*** Slip fit**

When a pin is fitted to a hole, some play is normally allowed. The tolerance range of the hole diameter is larger than the tolerance range for the pin diameter.

*** Press fit**

When a pin is fitted to a hole, there is a continuous interferential fit. The tolerance range of the hole diameter is less than the tolerance range for the pin diameter.

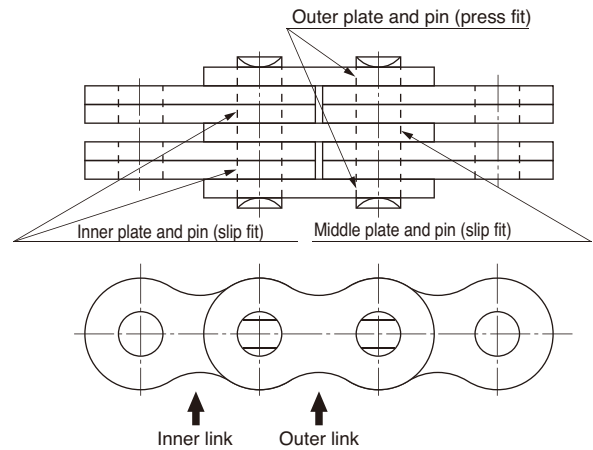

Types

There are two types of leaf chain: AL for light loads and BL for heavy loads. The dimensions and plate configuration for each is different.

AL Type External plate dimensions and thickness are the same as for the outer plates of RS Roller Chain with the same pitch, while the pin diameter is almost the same.

BL Type Plate width is the same as for the inner plates of RS Roller Chain of the same pitch. Plate thickness is the same as for one pitch larger RS roller chain, as is pin diameter.

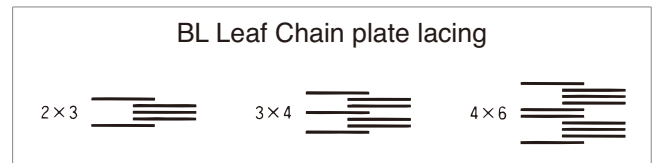
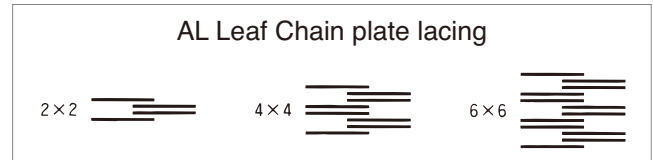

End links

1. Connecting link

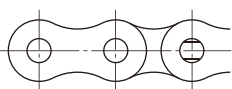
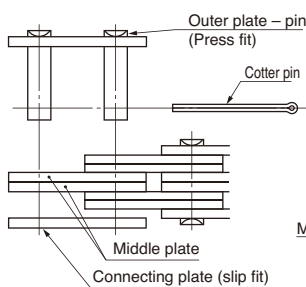

2. End link

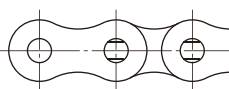
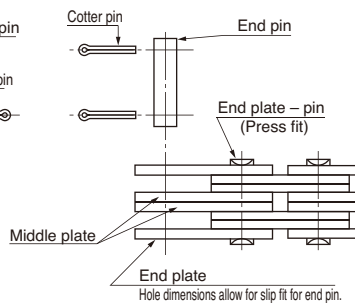

*Indicate the need for end pins or cotter pins. See pg. 99 for end pin dimensions.

3. Outer link

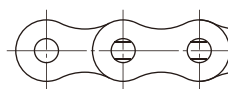
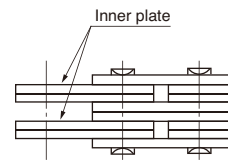

Note: All four types require a slip fit between inner / middle plate holes and pins.

Leaf Chains

Chain number

AL 4 22

Type
(AL or BL)

Lacing
(2 x 2)

Chain pitch (4 corresponds to RS40)

Dimensions

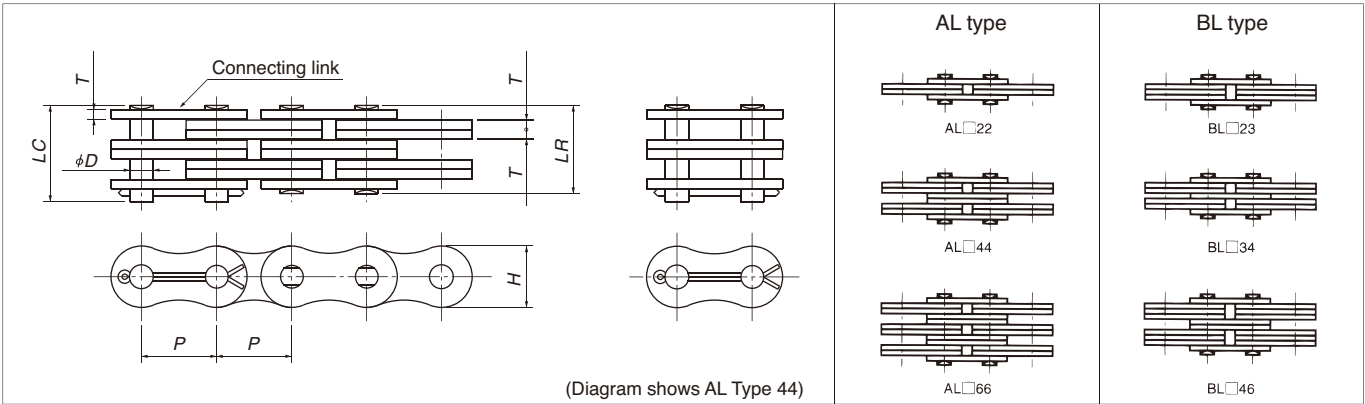

AL Type

TSUBAKI Chain Number	Pitch P	Plate Configuration	Plates		Pins			Minimum Tensile Strength kN{kgf}	Approximate Mass kg/m
			H	T	D	LR	LC		
AL422	12.70	2 × 2	10.4	1.5	3.96	8.30	9.70	16.7{ 1700}	0.38
AL444		4 × 4				14.70	16.20	33.3{ 3400}	0.74
AL466		6 × 6				20.80	22.25	50.0{ 5100}	1.10
AL522	15.875	2 × 2	13.0	2.0	5.08	10.80	12.30	27.5{ 2800}	0.62
AL544		4 × 4				18.90	20.50	54.9{ 5600}	1.22
AL566		6 × 6				27.40	28.90	82.4{ 8400}	1.81
AL622	19.05	2 × 2	15.6	2.4	5.95	12.90	14.90	38.2{ 3900}	0.87
AL644		4 × 4				22.70	25.20	76.5{ 7800}	1.71
AL666		6 × 6				32.80	35.40	115{11700}	2.54
AL822	25.40	2 × 2	20.8	3.2	7.90	16.35	19.15	64.7{ 6600}	1.51
AL844		4 × 4				29.80	32.60	129{13200}	2.98
AL866		6 × 6				43.20	46.00	194{19800}	4.44
AL1022	31.75	2 × 2	26.0	4.0	9.48	20.05	23.25	98.1{10000}	2.69
AL1044		4 × 4				36.70	39.90	196{20000}	5.31
AL1066		6 × 6				53.30	56.50	294{30000}	7.93
AL1222	38.10	2 × 2	31.2	4.8	11.04	24.20	27.90	141{14400}	3.57
AL1244		4 × 4				44.00	47.70	282{28800}	7.07
AL1266		6 × 6				63.85	67.55	424{43200}	10.56
AL1444	44.45	4 × 4	36.4	5.6	12.64	51.30	55.80	373{38000}	10.34
AL1466		6 × 6				74.55	79.05	559{57000}	15.16
AL1644	50.80	4 × 4	41.6	6.4	14.21	58.05	63.05	471{48000}	12.98
AL1666		6 × 6				84.45	89.45	706{72000}	19.41

BL Type

TSUBAKI Chain Number	Pitch P	Plate Configuration	Plates		Pins			Minimum Tensile Strength kN{kgf}	Approximate Mass kg/m
			H	T	D	LR	LC		
BL423	12.70	2 × 3	12.0	2.0	5.08	12.95	14.30	23.5{ 2400}	0.84
BL434		3 × 4				17.30	18.40	35.3{ 3600}	1.13
BL446		4 × 6				23.60	24.20	47.1{ 4800}	1.65
BL523	15.875	2 × 3	15.0	2.4	5.94	15.20	17.40	39.2{ 4000}	1.27
BL534		3 × 4				20.10	22.00	58.8{ 6000}	1.69
BL546		4 × 6				27.50	29.80	78.5{ 8000}	2.40
BL623	19.05	2 × 3	18.1	3.2	7.90	19.90	22.10	63.7{ 6500}	2.04
BL634		3 × 4				26.45	29.25	95.6{ 9750}	2.83
BL646		4 × 6				36.50	38.50	127{13000}	4.01
BL823	25.40	2 × 3	24.1	4.0	9.48	24.20	27.40	103{10500}	3.20
BL834		3 × 4				32.55	35.75	155{15800}	4.44
BL846		4 × 6				45.00	48.20	206{21000}	6.32
BL1023	31.75	2 × 3	30.1	4.8	11.04	28.90	32.60	141{14400}	4.69
BL1034		3 × 4				38.85	42.55	216{22000}	6.55
BL1046		4 × 6				53.70	57.40	282{28800}	9.29
BL1223	38.10	2 × 3	36.2	5.6	12.64	33.90	38.40	186{19000}	6.54
BL1234		3 × 4				45.50	50.00	299{30500}	9.10
BL1246		4 × 6				62.95	67.45	373{38000}	12.01
BL1423	44.45	2 × 3	42.2	6.4	14.21	38.20	43.20	235{24000}	9.06
BL1434		3 × 4				51.40	56.40	387{39500}	11.32
BL1446		4 × 6				71.25	76.25	471{48000}	18.00
BL1623	50.80	2 × 3	48.2	7.2	17.38	43.25	49.85	353{36000}	12.16
BL1634		3 × 4				58.40	65.00	554{56500}	16.95
BL1646		4 × 6				81.05	87.65	706{72000}	24.09

Note: The dimensions shown in this catalog are nominal dimensions and differ from actual dimensions.

Before Use | Standard Roller Chains | Lubrication | Heavy Duty Roller Chains | Corrosion Resistant Roller Chains | Specialty Roller Chains | Sprockets | Pin Gear Drives | Accessories | Selection | Handling

Leaf Chains

Clevises

Connecting links, end links, and inner links can all be used for Leaf Chain end fittings. When connecting end links (outer link, inner link), use the types of clevises shown below.

Connecting Leaf Chain to a clevis

1. Connecting the chain end to a (1) connecting link or (2) end link.

Connect an outer-link clevis to the connecting link or end link.

2. Connecting the chain end to a (3) inner link.

Connect an inner-link clevis to the end pin.

The end pin length varies according to the external width (W) of the clevis. When ordering, specify the W dimension.

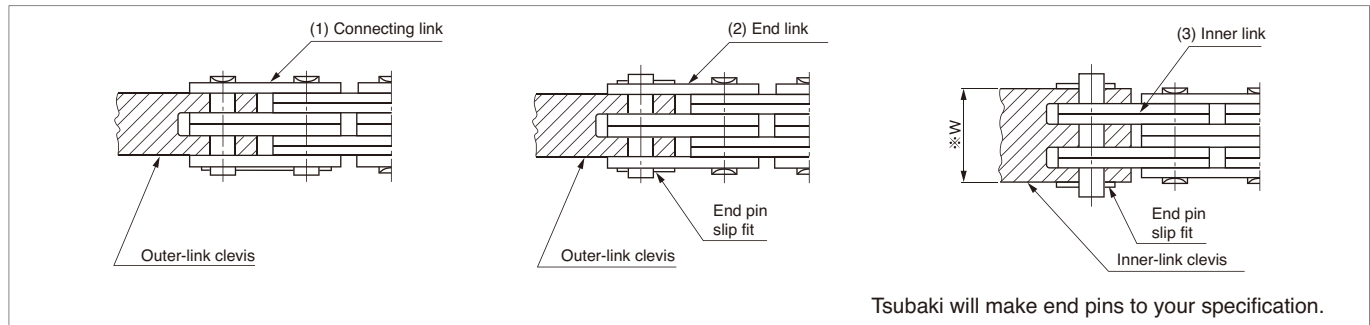

Clevis size and material

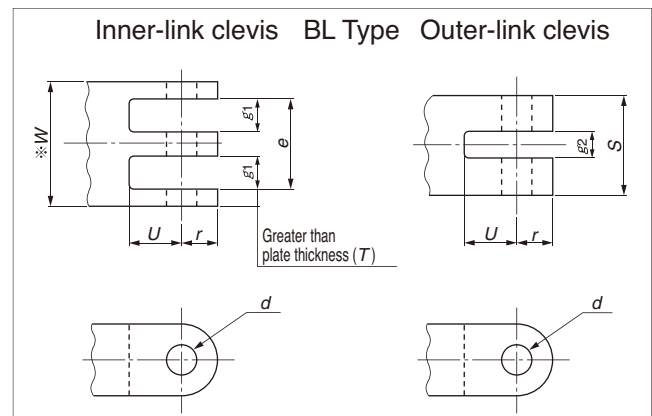
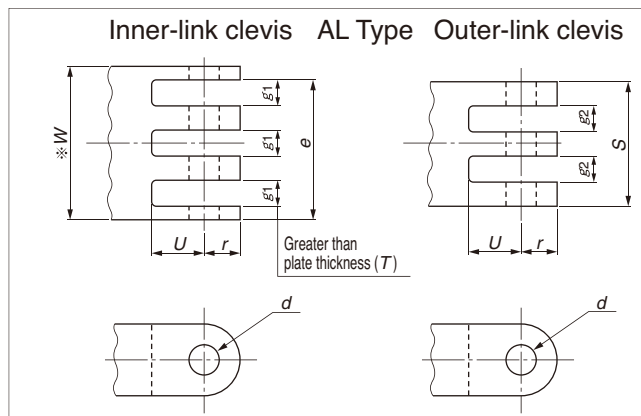

AL Leaf Chain Number	d	r (max.)	U (min.)	^{+0.2} ₀ e	^{+0.1} ₀ g1	⁰ _{-0.2} s	^{+0.1} ₀ g2
AL422	4.02	6.3	6.0	—	3.4	3.1	—
AL444				9.8		9.5	3.4
AL466				16.2		15.9	3.4
AL522	5.13	7.9	7.2	—	4.4	4.1	—
AL544				12.9		12.6	4.4
AL566				21.3		21.0	4.4
AL622	6.00	9.5	9.0	—	5.1	4.8	—
AL644				15.0		14.7	5.1
AL666				24.8		24.5	5.1
AL822	7.97	12.7	11.5	—	6.9	6.4	—
AL844				20.3		19.8	6.9
AL866				33.7		33.2	6.9
AL1022	9.57	15.8	14.5	—	8.5	8.0	—
AL1044				25.1		24.6	8.5
AL1066				41.7		41.2	8.5
AL1222	11.14	19.0	17.5	—	10.1	9.6	—
AL1244				29.9		29.4	10.1
AL1266				49.7		49.2	10.1
AL1444	12.74	22.2	20.0	35.1	11.9	34.5	11.9
AL1466				58.3		57.7	11.9
AL1644	14.32	25.4	23.0	39.9	13.5	39.2	13.5
AL1666				66.3		65.6	13.5

BL Leaf Chain Number	d	r (max.)	U (min.)	^{+0.2} ₀ e	^{+0.1} ₀ g1	⁰ _{-0.2} s	^{+0.1} ₀ g2	
BL423	5.13	6.3	6.3	—	6.5	6.2	—	
BL434				10.7		4.4	10.4	2.3
BL446				17.1		6.5	16.8	4.4
BL523	6.00	7.9	7.9	—	7.6	7.3	—	
BL534				12.5		5.1	12.2	2.6
BL546				19.9		7.6	19.6	5.1
BL623	7.97	9.5	9.5	—	10.3	9.8	—	
BL634				17.0		6.9	16.5	3.6
BL646				27.0		10.3	26.5	6.9
BL823	9.57	12.7	12.7	—	12.7	12.2	—	
BL834				21.0		8.5	20.5	4.4
BL846				33.4		12.7	32.9	8.5
BL1023	11.14	15.8	15.8	—	15.1	14.6	—	
BL1034				25.0		10.1	24.5	5.2
BL1046				39.8		15.1	39.3	10.1
BL1223	12.74	19.0	19.0	—	17.7	17.1	—	
BL1234				29.3		11.9	28.7	6.1
BL1246				46.7		17.7	46.1	11.9
BL1423	14.32	22.2	22.2	—	20.1	19.4	—	
BL1434				33.3		13.5	32.6	6.9
BL1446				53.1		20.1	52.4	13.5
BL1623	17.49	25.4	25.4	—	23.1	22.1	—	
BL1634				38.2		15.6	37.2	8.0
BL1646				60.9		23.1	59.9	15.6

Use heat-treated alloy steel (SCM435, etc.) in order to obtain a hardness of HRC40 to 45.

For clevises with screws, however, the hardness must be HRC30 to 35 in order to reduce any hazard due to delayed fractures.

Leaf Chains

■ End pins (for end links)

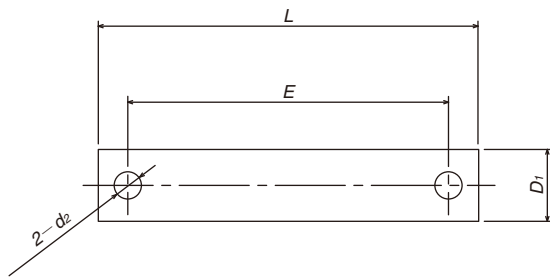

AL Type Leaf Chain Number	E (min.)	L (max.)	D ₁ (max.)	d ₂
AL422	7.4	11.2	3.96	1.2
AL444	13.9	17.7		
AL466	20.4	24.2		
AL522	10.0	14.0	5.06	1.6
AL544	18.5	22.5		
AL566	27.0	31.0		
AL622	11.8	16.5	5.92	2.0
AL644	21.7	26.4		
AL666	31.6	36.3		
AL822	15.85	22.1	7.88	2.5
AL844	29.25	35.5		
AL866	42.7	49.0		
AL1022	19.05	26.6	9.48	2.5
AL1044	35.7	43.3		
AL1066	52.3	59.9		
AL1222	22.7	31.5	11.04	3.0
AL1244	42.55	51.4		
AL1266	62.35	71.2		
AL1444	50.25	60.3	12.64	4.0
AL1466	73.45	83.5		
AL1644	56.65	68.0	14.21	4.0
AL1666	83.05	94.4		

BL Type Leaf Chain Number	E (min.)	L (max.)	D ₁ (max.)	d ₂
BL423	12.15	16.1	5.06	1.6
BL434	16.4	20.4		
BL446	22.75	26.8		
BL523	14.3	19.0	5.92	2.0
BL534	19.25	24.0		
BL546	26.65	31.4		
BL623	19.2	25.5	7.88	2.5
BL634	25.9	32.2		
BL646	36.0	42.3		
BL823	23.2	30.8	9.48	2.5
BL834	31.5	39.1		
BL846	44.0	51.6		
BL1023	27.65	36.4	11.04	3.0
BL1034	37.6	46.4		
BL1046	52.45	61.3		
BL1223	32.8	42.9	12.64	4.0
BL1234	44.45	54.6		
BL1246	61.85	72.0		
BL1423	36.85	48.2	14.21	4.0
BL1434	50.05	61.4		
BL1446	69.85	81.2		
BL1623	42.6	56.5	17.38	5.0
BL1634	57.7	71.6		
BL1646	80.35	94.3		

■ Sheaves

Refer to the following chart when manufacturing sheaves.

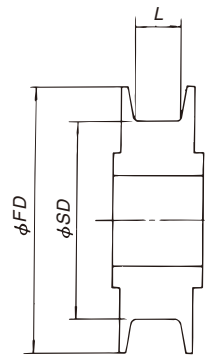

SD = Minimum external sheave diameter = chain pitch x 5
 L = Minimum groove width = pin length x 1.05
 FD = Flange external diameter
 = SD + maximum plate height (H)

AL Type

Chain Pitch	Minimum External Sheave Diameter SD	Flange External Diameter FD	Minimum Groove Width L		
			2 × 2	4 × 4	6 × 6
12.70	63.50	73.90	8.85	15.60	22.40
15.875	79.38	92.38	11.40	20.35	29.20
19.05	95.25	110.85	13.30	23.70	34.10
25.40	127.00	147.80	17.20	31.30	45.40
31.75	158.75	184.75	21.10	38.55	56.00
38.10	190.50	221.70	25.45	46.20	67.05
44.45	222.25	258.65	—	53.90	78.30
50.80	254.00	295.60	—	61.00	88.70

BL Type

Chain Pitch	Minimum External Sheave Diameter SD	Flange External Diameter FD	Minimum Groove Width L		
			2 × 3	3 × 4	4 × 6
12.70	63.50	75.50	13.60	18.10	24.80
15.875	79.38	94.38	15.90	21.15	28.90
19.05	95.25	113.35	20.75	27.80	38.35
25.40	127.00	151.10	25.45	34.20	47.25
31.75	158.75	188.85	30.35	40.80	56.40
38.10	190.50	226.70	35.60	47.80	66.10
44.45	222.25	264.45	40.15	54.00	74.85
50.80	254.00	302.20	45.45	61.35	85.15

- Dimensions for L in the table above assume that only the rivet pin is wound around the sheave. If a connecting pin is wound around the sheave, use $L \geq 2(L_2) \times 1.05$. Design L with an appropriate width while minding the installation precision of the sheave.
- Use sheaves made of machine-structural carbon copper. (S45C, etc.)
- Use heat-treated HRC (35 to 40) for high repetition applications.

Leaf Chains

Precautions for Use

- ① Lubricate regularly to prevent pin rotation and improve wear life.
Recommended lubrication: ISO VG 100 to 150 (SAE30 to SAE40)
Lubrication method: With the chain loose, use a brush or oil stick to sufficiently lubricate the outer chain, making sure that oil also penetrates between plates.
Lubrication period: Lubricate regularly so that sliding sections between pins and inner plates do not dry out.
- ② Avoid use in corrosive environments.
Wipe immediately when there is contact with water and lubricate well. When there is a possibility of corrosion, apply a large amount of grease to the surface of the chain. (To lubricate, wipe off grease and reapply after lubricating between plates.)
- ③ Check for elongation.
Replace chain when elongation reaches allowable elongation limit (3%).

Guidelines for checking chain elongation

In order to prevent chain backlash, measure with slight tension on the chain.
Use calipers to measure the distance between the outside L1 and inside L2 of the pins for the portion of the chain articulating around the sheave as shown in the illustration to obtain

$$L = (L_1 + L_2) / 2$$

Obtain chain elongation percentage using the following formula.

$$\text{Chain elongation} = \frac{L - \text{Standard length}}{\text{Standard length}} \times 100(\%)$$

$$\text{Standard length} = \text{Chain pitch} \times \text{No. of links}$$

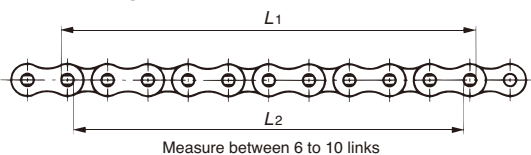

Note: Pitch elongation limit can be quickly checked with a chain elongation scale. For details, see pg. 120.

Ordering

Specify the chain number, number of links, chain end specifications, and link pin requirements.

- ① The following specifications exist for each end of the chain. Specify your preference.
 1. Connecting link
 2. End link (Outer and inner end link hole diameters are the same)
 3. Outer link
 4. Inner link
- ② If no chain end specification
With orders for an odd number of links, each end will be given an inner link. With orders for an even number of links, one end will have an inner link and the other a connecting link.
- ③ End pins are available.

Selection

1. Determine the following based on usage conditions.
 - Chain speed
 - Number of repetitions per day
 - Work load (including inertia and impact strength)
When a chain speed of 30 m/min or 1,000 cycles/day is exceeded, Leaf Chains may be inappropriate due to wear. Use an RS Roller Chain.
2. Determine the type of chain.
 - BL Type is recommended.
 - Limit use of AL Type to applications with no impact load or wear considerations (under 100 cycles/day).
3. Determine chain size using the following formula.

$$\text{Work load} \times \text{Usage coefficient (Table 1)} \times \text{Safety ratio (Table 2)} \leq \text{Minimum tensile strength}$$

4. ⚠ It is dangerous to use below the safety ratio in Table 2 as it may result in pin rotation and a reduction in strength. In addition, even if the safety ratio in Table 2 is followed, insufficient lubrication may also cause the pins to rotate. Always lubricate the chain regularly.

Table 1 Usage coefficient

Type of impact	Applications	Usage coefficient
Smooth power transmission	Starts and stops are smooth, and load changes are slight (balance weight suspension, etc.)	1.0
Slight impact	Repeated starts and stops, load changes, and reverse operation (forklifts, etc.)	1.3
Impact	Violent starts and stops, load changes, and reverse operation (mining and construction, etc.)	1.5

Table 2 Safety ratio

		Safety ratio	
		2 × 2, 3 × 4 2 × 3, 4 × 4	4 × 6 6 × 6
BL Type	1,000 cycles/day or less	8 or more	9 or more
	10 cycles/day or less	8 or more	9 or more
AL Type	100 cycles/day or less	12 or more	11 or more

5. Where determining a chain's safety ratio is established by law, select a chain with some leeway using that method and this catalog.

Leaf Chains

■ Standard packaging for super long length formations

The following packaging will be used unless otherwise specified.

Type	Chain No.	Packaging			
		Reel		Cardboard or CP packaging	
		Min. no. of links	Max. no. of links	Min. no. of links	Max. no. of links
AL Type	AL422	601	7200		
	AL444	601	4800		
	AL466	601	4800		
	AL522	481	3840		
	AL544	481	1920		
	AL566	481	1920		
	AL622	401	1600		
	AL644	401	1600		
	AL666	401	1600		
	AL822	301	600	601	1100
	AL844	301	600	601	1100
	AL866	301	600	601	1100
	AL1022	241	480	481	750
	AL1044	241	480	481	750
	AL1066	241	480	481	750
	AL1222			201	550
	AL1244			201	550
	AL1266			201	550
	AL1444			171	380
	AL1466			171	380
AL1644			151	300	
AL1666			151	300	

Type	Chain No.	Packaging			
		Reel		Cardboard or CP packaging	
		Min. no. of links	Max. no. of links	Min. no. of links	Max. no. of links
BL Type	BL423	601	4800		
	BL434	601	2400		
	BL446	601	2400		
	BL466	601	1200		
	BL523	481	1920		
	BL534	481	1920		
	BL544	481	1920		
	BL546	481	1920		
	BL566	481	960		
	BL622	401	1600		
	BL623	401	1600		
	BL634	401	1600		
	BL644	401	1600		
	BL646	401	1600		
	BL666	401	800		
	BL823	301	1200		
	BL834	301	600	601	1100
	BL844	301	600	601	1100
	BL846	301	600	601	1100
	BL866	301	600	601	1100
	BL1023	241	480	481	750
	BL1034	241	480	481	750
	BL1044	241	480	481	750
	BL1046	241	480	481	750
	BL1066	241	480	481	750
	BL1223			201	550
	BL1234			201	550
	BL1246			201	550
	BL1423			171	380
	BL1434			171	380
	BL1446			171	380
	BL1623			151	300
BL1634			151	300	
BL1646			151	300	

*Note: Super long length formations become easily twisted. Handle with care.
Tsubakimoto Chain is not responsible for any chain twisting after shipment.

RS Sprocket Selection Guide

Determine sprocket number of teeth and hub type in light of strength and space once you've determined your chain size and number of strands. Then, choose your sprocket series and type by considering whether your sprocket teeth will be hardened, the sprocket material, and bore finishing.

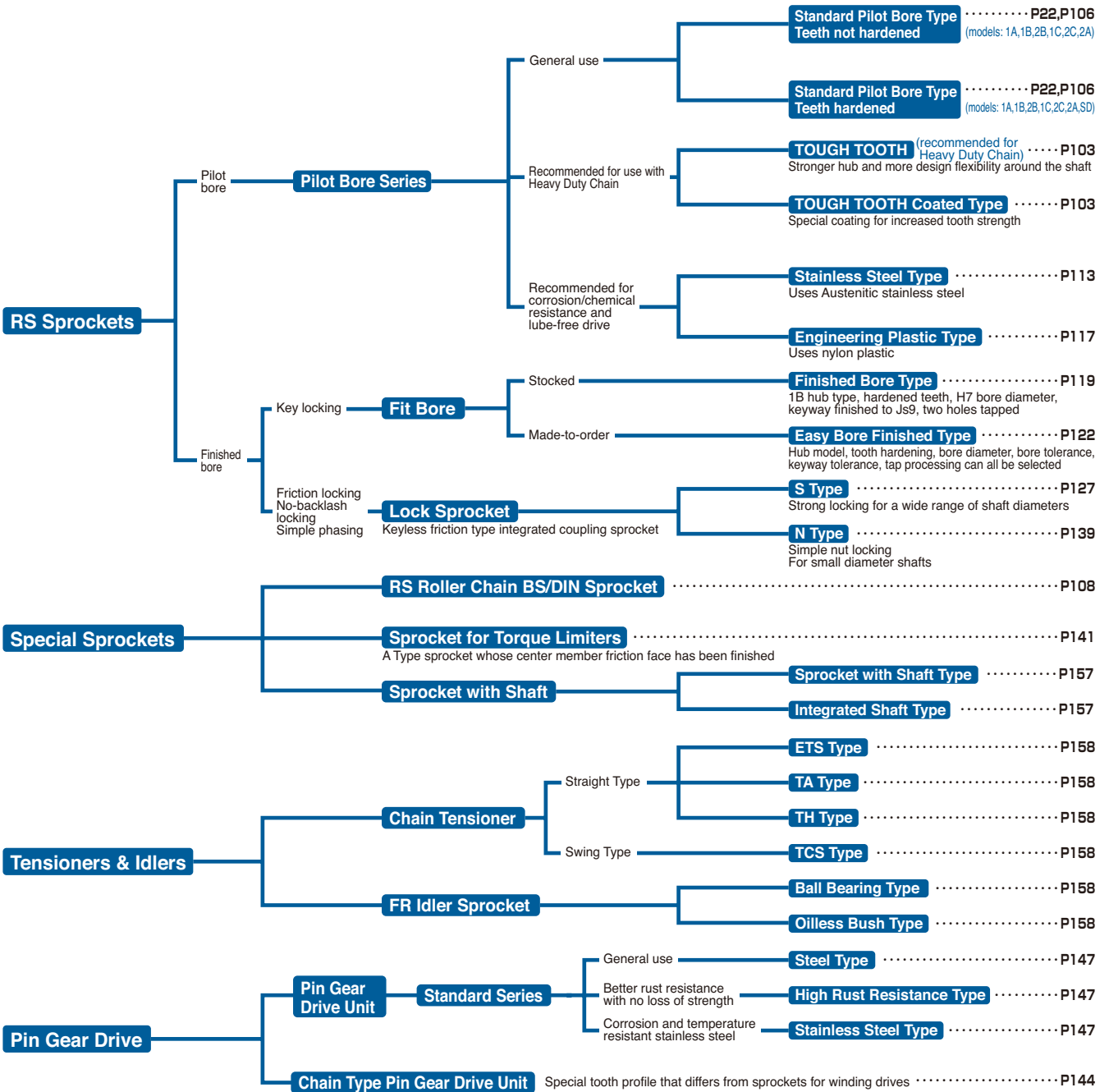

RS Sprocket TOUGH TOOTH

TOUGH TOOTH sprockets have increased strength and durability to bring out the best in Tsubaki's new G8 Series Heavy Duty Drive Chains.

RS Sprocket TOUGH TOOTH

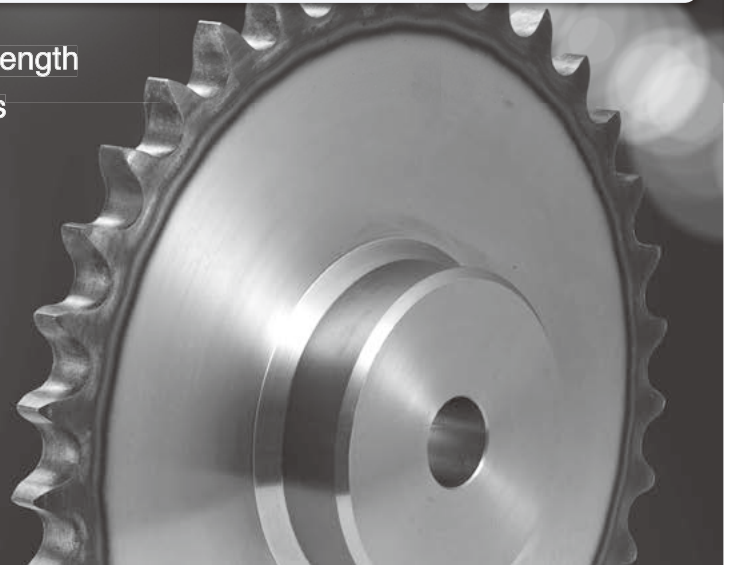

Features

- Teeth have ample strength to handle the increased strength of the G8 Series Heavy Duty Chain. The hub has been further strengthened as well.
- All models feature hardened teeth to give the sprocket more wear resistance.
- A special coating that even further increases tooth hardness is also available (optional) Ideal for harsh operating environments where users want to reduce chain and sprocket replacement frequency. The coating gives the sprocket a surface hardness of over Hv800 for better wear resistance.

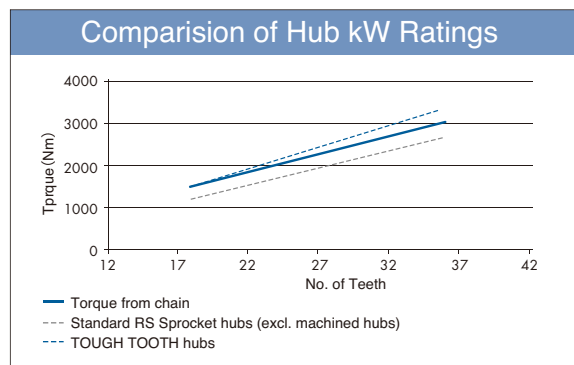
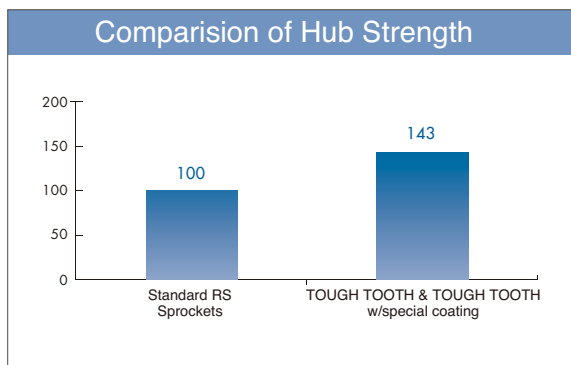

Note: 1. Torque is calculated from keyway allowable surface pressure using a JIS parallel key at the maximum shaft hub diameter.
2. Comparison using RS80-SUP-H-1.

Specifications

- B and C types standardized for single and double strand RS-HT Series RS60 and above.
- RS-HT Chains and Super-H Chains in multi strand configurations have a different tooth transverse pitch than RS Roller Chain sprockets.
- Other multi strand configurations, hub types, and numbers of teeth are made-to-order. Other shaft hub finishing also available.
- Both teeth and hubs use carbon steel for machine structural use.
- Made-to-order product.

Model Numbering Example

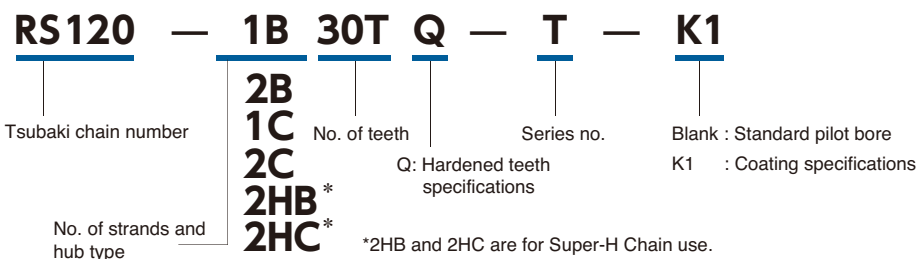

RS Sprocket TOUGH TOOTH

Available Range

 RS TOUGH TOOTH Sprockets

 Use standard RS Sprockets

 Made-to-order

● 1B (single strand B type)

No. of Teeth	RS60	RS80	RS100	RS120	RS140	RS160	RS180	RS200	RS240
9T									
10T									
11T									
12T									
13T									
14T									
15T									
16T									
17T									
18T									
19T									
20T									
21T									
22T									
23T									
24T									
25T									
26T									
27T									
28T									
30T									
32T									
34T									
35T									
36T									
38T									
40T or more									

● 1C (single strand C type)

No. of Teeth	RS60	RS80	RS100	RS120	RS140	RS160	RS180	RS200	RS240
9T									
10T									
11T									
12T									
13T									
14T									
15T									
16T									
17T									
18T									
19T									
20T									
21T									
22T									
23T									
24T									
25T									
26T									
27T									
28T									
30T									
32T									
34T									
35T									
36T									
38T									
40T or more									

See pgs. 32 – 48 for mass and dimensions.

- Contact a Tsubaki representative regarding models with dimensions not shown in this catalog.
- Sizes, numbers of strands, numbers of teeth, and hub dimensions other than those shown above available. Contact a Tsubaki representative for more information.

RS Sprocket TOUGH TOOTH

● 2B (double strand B type)

No. of Teeth	RS60	RS80	RS100	RS120	RS140~240
9T					
10T					
11T					
12T					
13T					
14T					
15T					
16T					
17T					
18T					
19T					
20T					
21T					
22T					
23T					
24T					
25T					
26T					
27T					
28T					
30T					
32T					
34T					
35T					
36T or more					

● 2C (double strand C type)

No. of Teeth	RS60	RS80	RS100	RS120	RS140~240
9T					
10T					
11T					
12T					
13T					
14T					
15T					
16T					
17T					
18T					
19T					
20T					
21T					
22T					
23T					
24T					
25T					
26T					
27T					
28T					
30T					
32T					
34T					
35T					
36T or more					

See [pgs. 32 – 48](#) for mass and dimensions.

- The transverse pitch of the teeth will differ for RS-HT and Super-H Chains in configurations of more than two strands.
- Contact a Tsubaki representative regarding models with dimensions not shown in this catalog.
- Sizes, numbers of strands, numbers of teeth, and hub dimensions other than those shown above available. Contact a Tsubaki representative for more information.

Optional (made-to-order)

Special Coating Specifications

A special coating gives the teeth a hardness of over HV800 for better wear resistance. Effective in harsh operating environments where sprocket replacement frequency is high.

Shaft Bore Finishing Service

Optional shaft bore finishing service available.

Shaft Set Delivery

We can quote you for a shaft based on your drawings, manufacture it, and supply it together with your sprocket as a set. By also requesting inspection records, you can reduce inspection/assembly man-hours and cost.

(See [pg. 157.](#))

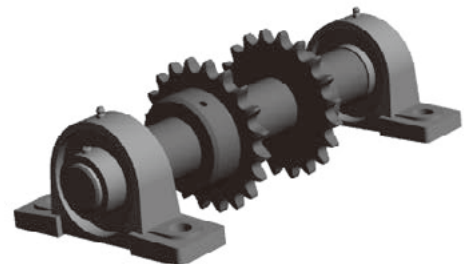

RS Sprocket 2A Type (Pilot bore or Strong Pilot bore types)

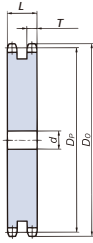

2A Sprocket Teeth and Lateral Width Dimensions

Type	Width <i>L</i>	Tooth Width <i>T</i>
RS40-2A	21.5	7.1
RS50-2A	26.8	8.7
RS60-2A	34.5	11.7
RS80-2A	43.9	14.6
RS100-2A	53.4	17.6
RS120-2A	68.9	23.5

Hanging hole dimensions

(Bore diameter: RS60/RS80: ϕ 30, RS100, RS120: ϕ 35)

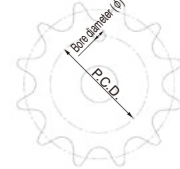

The phase relationship between hanging hole and teeth may differ from the drawing.

●RS40

Model Number	Pitch Circle Diameter <i>D_p</i>	(Outer Diameter) <i>(D_o)</i>	Pilot Bore Diameter <i>d</i>	Approximate Mass (kg)	Material
RS40-2A35T	141.68	149	16	2.4	Machine-structural carbon steel, machined.
RS40-2A36T	145.72	153	16	2.5	
RS40-2A38T	153.79	161	16	2.8	
RS40-2A40T	161.87	169	16	3.1	
RS40-2A42T	169.94	177	16	3.5	
RS40-2A45T	182.06	189	18	4.0	
RS40-2A48T	194.18	201	18	4.6	
RS40-2A50T	202.26	209	18	5.0	
RS40-2A54T	218.42	226	18	5.8	
RS40-2A60T	242.66	250	18	7.3	

●RS60

Model Number	Pitch Circle Diameter <i>D_p</i>	(Outer Diameter) <i>(D_o)</i>	Pilot Bore Diameter <i>d</i>	Approximate Mass (kg)	Material	Bore Phase (P.C.D.)
RS60-2A23T	139.90	150	18	3.5	Machine-structural carbon steel, machined.	
RS60-2A24T	145.95	156	18	3.8		
RS60-2A25T	151.99	162	18	4.2		
RS60-2A26T	158.04	168	18	4.6		
RS60-2A27T	164.09	174	18	4.9		
RS60-2A28T	170.14	180	18	5.4		
RS60-2A30T	182.25	193	18	6.2		
RS60-2A32T	194.35	205	18	7.1		
RS60-2A34T	206.46	217	18	8.1		
RS60-2A35T	212.52	223	18	8.6		
RS60-2A36T	218.57	229	18	9.1		
RS60-2A38T	230.69	241	18	10.2		
RS60-2A40T	242.80	253	18	11.4		
RS60-2A42T	254.92	266	23	12.6		
RS60-2A45T	273.09	284	23	14.5		
RS60-2A48T	291.27	302	23	16.6		
RS60-2A50T	303.39	314	23	18.1		
RS60-2A54T	327.63	338	23	21.2		
RS60-2A60T	363.99	375	23	26.2		

●RS100

Model Number	Pitch Circle Diameter <i>D_p</i>	(Outer Diameter) <i>(D_o)</i>	Pilot Bore Diameter <i>d</i>	Approximate Mass (kg)	Material	Bore Phase (P.C.D.)
RS100-2A15T	152.71	168	28	5.8	Machine-structural carbon steel, machined.	
RS100-2A16T	162.75	179	28	6.8		
RS100-2A17T	172.79	189	28	7.8		
RS100-2A18T	182.84	199	28	8.8		
RS100-2A19T	192.90	209	28	10.0		
RS100-2A20T	202.96	220	28	11.2		
RS100-2A21T	213.03	230	28	12.4		
RS100-2A22T	223.10	240	33	13.7		
RS100-2A23T	233.17	250	33	15.0		
RS100-2A24T	243.25	260	33	16.5		
RS100-2A25T	253.32	270	33	18.1		
RS100-2A26T	263.41	281	33	19.7		
RS100-2A27T	273.49	291	33	21.3		
RS100-2A28T	283.57	301	33	23.0		
RS100-2A30T	303.75	321	33	26.8		
RS100-2A32T	323.92	341	33	30.3		
RS100-2A34T	344.10	362	33	34.5		
RS100-2A35T	354.20	372	33	36.7		
RS100-2A36T	364.29	382	33	38.9		
RS100-2A38T	384.48	402	33	43.7		
RS100-2A40T	404.67	422	33	48.7		
RS100-2A42T	424.86	443	33	53.9		
RS100-2A45T	455.15	473	33	62.4		
RS100-2A48T	485.45	503	33	71.4		
RS100-2A50T	505.65	524	33	77.7		
RS100-2A54T	546.05	564	33	91.2		
RS100-2A60T	606.66	625	33	113.4		

■Ordering Example

RS40 -2A 35T Q

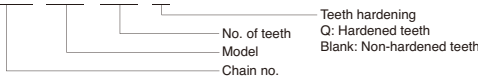

Teeth hardening
Q: Hardened teeth
Blank: Non-hardened teeth

●RS50

Model Number	Pitch Circle Diameter <i>D_p</i>	(Outer Diameter) <i>(D_o)</i>	Pilot Bore Diameter <i>d</i>	Approximate Mass (kg)	Material
RS50-2A26T	131.70	140	18	2.4	Machine-structural carbon steel, machined.
RS50-2A27T	136.74	145	18	2.6	
RS50-2A28T	141.79	150	18	2.8	
RS50-2A30T	151.87	161	18	3.3	
RS50-2A32T	161.96	171	18	3.8	
RS50-2A34T	172.05	181	18	4.3	
RS50-2A35T	177.10	186	18	4.6	
RS50-2A36T	182.15	191	18	4.9	
RS50-2A38T	192.24	201	18	5.5	
RS50-2A40T	202.33	211	23	6.0	
RS50-2A42T	212.43	221	23	6.7	
RS50-2A45T	227.58	237	23	7.7	
RS50-2A48T	242.73	252	23	8.9	
RS50-2A50T	252.82	262	23	9.7	
RS50-2A54T	273.03	282	23	11.3	
RS50-2A60T	303.33	312	23	14.1	

●RS80

Model Number	Pitch Circle Diameter <i>D_p</i>	(Outer Diameter) <i>(D_o)</i>	Pilot Bore Diameter <i>d</i>	Approximate Mass (kg)	Material	Bore Phase (P.C.D.)
RS80-2A18T	146.27	159	23	4.6	Machine-structural carbon steel, machined.	
RS80-2A19T	154.32	167	23	5.2		
RS80-2A20T	162.37	176	23	5.8		
RS80-2A21T	170.42	184	23	6.5		
RS80-2A22T	178.48	192	28	7.1		
RS80-2A23T	186.54	200	28	7.9		
RS80-2A24T	194.60	208	28	8.6		
RS80-2A25T	202.66	216	28	9.4		
RS80-2A26T	210.72	224	28	10.2		
RS80-2A27T	218.79	233	28	11.1		
RS80-2A28T	226.86	241	28	12.0		
RS80-2A30T	243.00	257	28	14.0		
RS80-2A32T	259.14	273	28	16.0		
RS80-2A34T	275.28	289	28	18.2		
RS80-2A35T	283.36	297	28	19.4		
RS80-2A36T	291.43	306	28	20.6		
RS80-2A38T	307.58	322	28	23.0		
RS80-2A40T	323.74	338	33	25.4		
RS80-2A42T	339.89	354	33	28.1		
RS80-2A45T	364.12	378	33	32.5		
RS80-2A48T	388.36	403	33	37.3		
RS80-2A50T	404.52	419	33	40.6		
RS80-2A54T	436.84	451	33	47.7		
RS80-2A60T	485.33	500	33	59.4		

●RS120

Model Number	Pitch Circle Diameter <i>D_p</i>	(Outer Diameter) <i>(D_o)</i>	Pilot Bore Diameter <i>d</i>	Approximate Mass (kg)	Material	Bore Phase (P.C.D.)
RS120-2A14T	171.22	190	28	9.6	Machine-structural carbon steel, machined.	
RS120-2A15T	183.25	202	33	11.1		
RS120-2A16T	195.29	214	33	12.9		
RS120-2A17T	207.35	227	33	14.7		
RS120-2A18T	219.41	239	33	16.7		
RS120-2A19T	231.48	251	33	18.8		
RS120-2A20T	243.55	263	33	21.1		
RS120-2A21T	255.63	276	33	23.5		
RS120-2A22T	267.72	288	33	25.9		
RS120-2A23T	279.80	300	33	28.5		
RS120-2A24T	291.90	312	33	31.3		
RS120-2A25T	303.99	324	33	34.2		
RS120-2A26T	316.09	337	33	37.2		
RS120-2A27T	328.19	349	33	40.3		
RS120-2A28T	340.29	361	33	43.5		
RS120-2A30T	364.49	385	33	49.9		
RS120-2A32T	388.71	410	33	57.2		
RS120-2A34T	412.93	434	33	65.0		
RS120-2A35T	425.04	446	33	69.1		
RS120-2A36T	437.15	458	38	73.2		
RS120-2A38T	461.37	483	38	82.1		
RS120-2A40T	485.60	507	38	91.3		
RS120-2A42T	509.83	531	38	101.2		
RS120-2A45T	546.19	568	38	116.9		
RS120-2A48T	582.54	604	38	133.6		
RS120-2A50T	606.78	628	38	145.5		
RS120-2A54T	655.26	677	38	170.6		
RS120-2A60T	727.99	750	38	212.0		

Note: 1. Maximum bore diameters shown are standard figures. Decide and confirm bore diameters and key surface pressures based on standard machinery design.
 2. Sprockets shown with hole positions come with a hanging hole on the sprocket plate. Refer to the diagram above for hanging hole dimensions.
 3. The dimensions shown in this catalog are nominal dimensions and differ from actual dimensions.

Before Use
 Standard Roller Chains
 Live-Free Roller Chains
 Heavy Duty Roller Chains
 Corrosion Resistant Roller Chains
 Specialty Roller Chains
 Sprockets
 Pin Gear Drives
 Accessories
 Selection
 Handling

RS Sprocket Single Dual Type

Two strands of single strand chain can be mounted simultaneously

RS40 SD Type

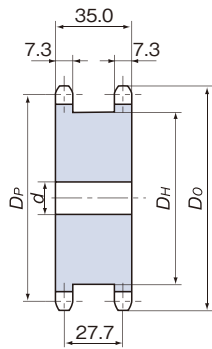

Model numbering example

RS40-SD-□□TQ

Q: Hardened teeth specifications
No. of teeth

RS50 SD Type

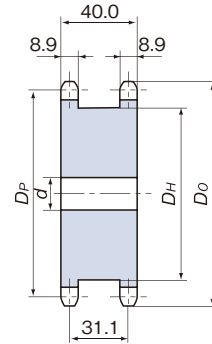

Model numbering example

RS50-SD-□□TQ

Q: Hardened teeth specifications
No. of teeth

RS40 All models have hardened teeth.

Model Number	Pitch Circle Dia. D_P	(Outer Dia.) (D_o)	Bore dia. d		Hub		Approximate Mass (kg)
			Pilot Bore	Max.	Diameter D_H	Length L	
RS40-SD-12TQ	49.07	55	9.5	19	34	35	0.34
RS40-SD-13TQ	53.07	59	12.7	22	38	35	0.40
RS40-SD-14TQ	57.07	63	12.7	24	42	35	0.48
RS40-SD-15TQ	61.08	67	12.7	27	46	35	0.56
RS40-SD-16TQ	65.10	71	12.7	31	50	35	0.66
RS40-SD-17TQ	69.12	76	12.7	34	54	35	0.76
RS40-SD-18TQ	73.14	80	12.7	38	59	35	0.88
RS40-SD-19TQ	77.16	84	12.7	41	63	35	0.99
RS40-SD-20TQ	81.18	88	12.7	44	67	35	1.12
RS40-SD-21TQ	85.21	92	12.7	47	71	35	1.24
RS40-SD-22TQ	89.24	96	12.7	50	75	35	1.38
RS40-SD-23TQ	93.27	100	12.7	51	78	35	1.50
RS40-SD-24TQ	97.30	104	12.7	55	83	35	1.67
RS40-SD-25TQ	101.33	108	12.7	58	87	35	1.83

Material/Specifications Machine-structural carbon steel, machined.

Contact a Tsubaki representative for teeth numbers not shown above.

RS50 All models have hardened teeth.

Model Number	Pitch Circle Dia. D_P	(Outer Dia.) (D_o)	Bore dia. d		Hub		Approximate Mass (kg)
			Pilot Bore	Max.	Diameter D_H	Length L	
RS50-SD-12TQ	61.34	69	12.7	25	43	40	0.62
RS50-SD-13TQ	66.33	74	12.7	29	48	40	0.75
RS50-SD-14TQ	71.34	79	12.7	33	53	40	0.90
RS50-SD-15TQ	76.35	84	12.7	37	58	40	1.05
RS50-SD-16TQ	81.37	89	12.7	41	63	40	1.22
RS50-SD-17TQ	86.39	94	12.7	44	68	40	1.40
RS50-SD-18TQ	91.42	100	12.7	48	73	40	1.60
RS50-SD-19TQ	96.45	105	15.9	52	79	40	1.80
RS50-SD-20TQ	101.48	110	15.9	56	84	40	2.02
RS50-SD-21TQ	106.51	115	15.9	60	89	40	2.25
RS50-SD-22TQ	111.55	120	15.9	62	92	40	2.44
RS50-SD-23TQ	116.59	125	15.9	67	99	40	2.75
RS50-SD-24TQ	121.62	130	15.9	70	102	40	2.96
RS50-SD-25TQ	126.66	135	15.9	75	109	40	3.30

Material/Specifications Machine-structural carbon steel, machined.

Contact a Tsubaki representative for teeth numbers not shown above.

RS60 SD Type

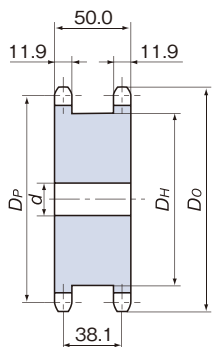

Model numbering example

RS60-SD-□□TQ

Q: Hardened teeth specifications
No. of teeth

RS80 SD Type

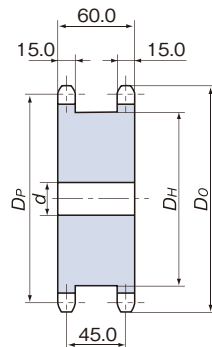

Model numbering example

RS80-SD-□□TQ

Q: Hardened teeth specifications
No. of teeth

RS60 All models have hardened teeth.

Model Number	Pitch Circle Dia. D_P	(Outer Dia.) (D_o)	Bore dia. d		Hub		Approximate Mass (kg)
			Pilot Bore	Max.	Diameter D_H	Length L	
RS60-SD-12TQ	73.60	83	12.7	31	51	50	1.16
RS60-SD-13TQ	79.60	89	15.9	36	57	50	1.37
RS60-SD-14TQ	85.61	95	15.9	42	64	50	1.65
RS60-SD-15TQ	91.63	101	15.9	46	70	50	1.93
RS60-SD-16TQ	97.65	107	15.9	50	76	50	2.24
RS60-SD-17TQ	103.67	113	15.9	55	82	50	2.57
RS60-SD-18TQ	109.70	119	15.9	59	88	50	2.92
RS60-SD-19TQ	115.74	126	15.9	64	94	50	3.29
RS60-SD-20TQ	121.78	132	15.9	68	100	50	3.69
RS60-SD-21TQ	127.82	138	15.9	74	107	50	4.14
RS60-SD-22TQ	133.86	144	15.9	78	113	50	4.58
RS60-SD-23TQ	139.90	150	18	82	119	50	5.02
RS60-SD-24TQ	145.95	156	18	87	125	50	5.51
RS60-SD-25TQ	151.99	162	18	91	130	50	5.98

Material/Specifications Machine-structural carbon steel, machined.

Contact a Tsubaki representative for teeth numbers not shown above.

RS80 All models have hardened teeth.

Model Number	Pitch Circle Dia. D_P	(Outer Dia.) (D_o)	Bore dia. d		Hub		Approximate Mass (kg)
			Pilot Bore	Max.	Diameter D_H	Length L	
RS80-SD-12TQ	98.14	110	20	45	69	60	2.5
RS80-SD-13TQ	106.14	118	20	50	77	60	3.0
RS80-SD-14TQ	114.15	127	20	55	85	60	3.6
RS80-SD-15TQ	122.17	135	20	63	93	60	4.2
RS80-SD-16TQ	130.20	143	20	70	102	60	4.9
RS80-SD-17TQ	138.23	151	20	74	110	60	5.6
RS80-SD-18TQ	146.27	159	20	80	118	60	6.4

Material/Specifications Machine-structural carbon steel, machined.

Contact a Tsubaki representative for teeth numbers not shown above.

All models stocked.

Note: 1. Maximum bore diameters shown are standard figures. Decide and confirm bore diameters and key surface pressures based on standard machinery design.
2. The dimensions shown in this catalog are nominal dimensions and differ from actual dimensions.

RS Roller Chain BS/DIN Sprockets

BS standard (European standard) roller chain requires a special sprocket. (BS/DIN sprockets have a different number of teeth and outer diameter than RS Sprockets/JIS standards.)

Series : Sizes (ex.: 20B, 56B) and dimensions not shown in this catalog also available. Contact a Tsubaki representative for more information.

Bore finishing: Bore finishing available for ranges of bore diameter d shown in the dimensional chart for each size.

Tooth hardening: Models shaded in the dimensional chart are models with tooth hardening as standard. Tooth hardening is available on other (non-shaded) models as well. Indicate tooth hardening on your request for quotation.

Delivery : Made-to-order

RF06B

Model Numbering Example

RF06B - 1B 9T Q

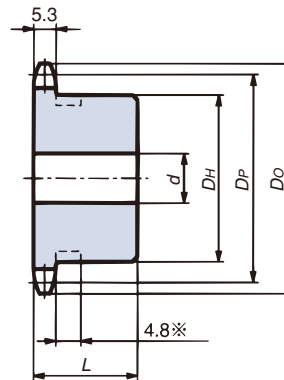
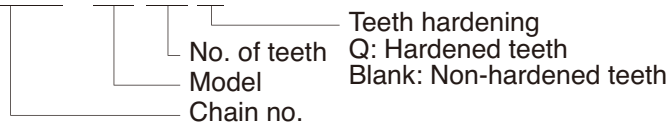

(Machined specifications)
1B Type

Model Number	Outer Dia. D_o	Pitch Dia. D_p	1B Type				Approx. mass kg	Construction/ material	No. of Teeth
			Bore dia. d		Hub				
			Pilot bore	Max.	Dia. D_H	Total length L			
RF06B-1B9TQ	30	27.85	8	11	21	20	0.06	*	9
RF06B-1B10TQ	33	30.82	8	12	24	20	0.08	*	10
RF06B-1B11TQ	36	33.81	8	13	26	20	0.09	*	11
RF06B-1B12TQ	39	36.80	8	16	30	20	0.12	*	12
RF06B-1B13TQ	42	39.80	9.53	18	32	20	0.12	*	13
RF06B-1B14TQ	45	42.80	9.53	16.5	30	20	0.12	(*4)	14
RF06B-1B15TQ	48	45.81	9.53	19	35	20	0.16		15
RF06B-1B16TQ	51	48.82	9.53	20	37	20	0.19		16
RF06B-1B17TQ	54	51.84	9.53	24	41	20	0.22		17
RF06B-1B18TQ	57	54.85	9.53	24.5	44	20	0.25		18
RF06B-1B19TQ	60	57.87	9.53	28.5	47	20	0.28		19
RF06B-1B20TQ	63	60.89	9.53	30	50	20	0.32		20
RF06B-1B21TQ	66	63.91	9.53	32	53	20	0.36		21
RF06B-1B22TQ	69	66.93	9.53	32	53	20	0.37		22
RF06B-1B23TQ	72	69.95	9.53	32	53	20	0.40		23
RF06B-1B24TQ	75	72.97	9.53	32	53	22	0.43		24
RF06B-1B25TQ	78	76.00	12.7	32	53	22	0.44		25
RF06B-1B26TQ	81	79.02	12.7	32	53	22	0.45		26
RF06B-1B27TQ	84	82.05	12.7	32	53	22	0.46		27
RF06B-1B28TQ	87	85.07	12.7	32	53	22	0.48		28
RF06B-1B30TQ	93	91.12	12.7	32	53	22	0.51		30
RF06B-1B32TQ	99	97.18	12.7	32	53	22	0.54		32
RF06B-1B34TQ	105	103.23	12.7	32	53	22	0.57		34
RF06B-1B35TQ	108	106.26	12.7	32	53	22	0.59		35
RF06B-1B36TQ	111	109.29	12.7	32	53	22	0.61		36
RF06B-1B38TQ	117	115.34	13	42	63	25	0.82		38
RF06B-1B40TQ	123	121.40	13	42	63	25	0.85		40
RF06B-1B42T	129	127.46	13	42	63	25	0.91		42
RF06B-1B45T	138	136.55	13	42	63	25	0.95		45
RF06B-1B48T	148	145.64	13	42	63	25	1.0		48
RF06B-1B50T	154	151.69	13	42	63	25	1.1		50
RF06B-1B54T	167	163.82	13	42	63	25	1.2		54
RF06B-1B60T	185	182.00	13	42	63	25	1.3		60

Note: 1. Maximum bore diameters shown are standard figures. Decide and confirm bore diameters and key surface pressures based on standard machinery design.

2. Models shaded in the chart above are hardened.

3. Items not hardened as standard are available as made-to-order.

4. Items marked with an * above have a groove around the periphery of the hub. The groove outer diameter is 9T: 16, 10T: 18, 11T: 22, and 13T: 28.

5. The dimensions shown in this catalog are nominal dimensions and differ from actual dimensions.

RS Roller Chain BS/DIN Sprockets

RS08B

Model Numbering Example

RS08B -1 B 9T Q

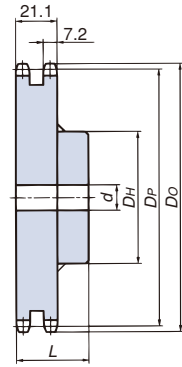
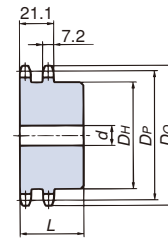
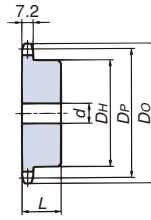
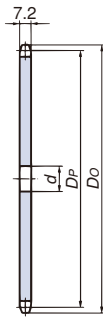
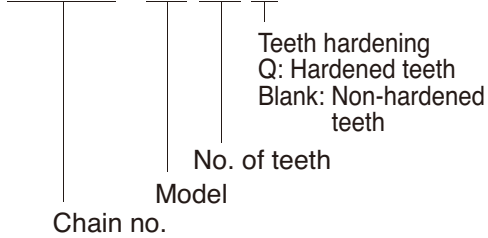

Model Number	Outer Dia. (*4) Do	Pitch Dia. DP	1A Type			1B Type					2B Type					No. of Teeth			
			Pilot Bore d	Approx. mass kg	Construction/ material	Bore dia. d		Hub		Approx. mass kg	Construction/ material	Bore dia. d		Hub			Approx. mass kg	Construction/ material	
						Pilot bore	Max.	Dia. DH	Total length L			Pilot bore	Max.	Dia. DH	Total length L				
RS08B-1B9TQ	41	37.13			Structural carbon steel	9.53	15	28	22	0.12	Machined specifications Carbon steel for machine structural use							9	
RS08B-1B10TQ	45	41.10				9.53	16.5	32	22	0.16									10
RS08B-1B11TQ	49	45.08				9.53	18	36	22	0.20									11
RS08B-1B12TQ	53	49.07	16	0.10		9.53	22	40	22	0.24			9.53	18	32	35	0.34		12
RS08B-1B13TQ	57	53.07	16	0.11		9.53	20	37	22	0.24		(*)5	12.7	20	37	35	0.39		13
RS08B-1B14TQ	61	57.07	16	0.13		9.53	24	42	22	0.29		Machined specifications Carbon steel for machine structural use	12.7	24	42	35	0.47	Machined specifications Carbon steel for machine structural use	14
RS08B-1B15TQ	65	61.08	16	0.14		9.53	28.5	46	22	0.34			12.7	29	46	35	0.56		15
RS08B-1B16TQ	69	65.10	16	0.16		12.7	30	50	22	0.39			12.7	30	50	35	0.65		16
RS08B-1B17TQ	73	69.12	16	0.19		12.7	32	54	22	0.45			12.7	32	54	35	0.75		17
RS08B-1B18TQ	77	73.14	16	0.21		12.7	35	57	22	0.51			12.7	35	57	35	0.85		18
RS08B-1B19TQ	81	77.16	16	0.24		12.7	39.5	62	22	0.59			12.7	40	62	35	0.98		19
RS08B-1B20TQ	85	81.18	16	0.26		12.7	45.5	67	25	0.76			12.7	46	67	40	1.3		20
RS08B-1B21TQ	89	85.21	16	0.29		12.7	45.5	71	25	0.85			12.7	47	71	40	1.4		21
RS08B-1B22TQ	93	89.24	16	0.32		12.7	50	75	25	0.95			12.7	50	75	40	1.6		22
RS08B-1B23TQ	97	93.27	16	0.35		12.7	50	77	25	1.0			12.7	50	77	40	1.7		23
RS08B-1B24TQ	102	97.30	16	0.38		12.7	42	63	25	0.84			12.7	55	83	40	1.9		24
RS08B-1B25TQ	106	101.33	16	0.41		12.7	42	63	25	0.88			12.7	59	87	40	2.1		25
RS08B-1B26TQ	110	105.36	16	0.45		12.7	42	63	25	0.92			12.7	62	91	40	2.3		26
RS08B-1B27TQ	114	109.40	16	0.52		12.7	42	63	25	0.96			12.7	65	95	40	2.4		27
RS08B-1B28TQ	118	113.43	16	0.56		12.7	42	63	25	1.00			12.7	67	99	40	2.6		28
RS08B-1B30TQ	126	121.50	16	0.60		12.7	42	63	25	1.10			12.7	73	106	40	3.0		30
RS08B-1B32TQ	134	129.57	16	0.68		16	45	68	28	1.30			12.7	78	115	50	4.3		32
RS08B-1B34TQ	142	137.64	16	0.77		16	45	68	28	1.30			12.7	84	124	50	5.0		34
RS08B-1B35TQ	146	141.68	16	0.82	16	45	68	28	1.40	16	63		93	50	3.9	35			
RS08B-1B36TQ	150	145.72	16	0.87	16	45	68	28	1.40	16	63		93	50	4.0	36			
RS08B-1B38TQ	158	153.79	16	0.96	16	45	68	28	1.5	16	63		93	50	4.3	38			
RS08B-1B40TQ	166	161.87	16	1.1	16	45	68	28	1.6	16	63		93	50	4.7	40			
RS08B-1B42T	174	169.94	18	1.2	18	48	73	32	2.0	16	63		93	50	5.0	42			
RS08B-1B45T	186	182.06	18	1.4	18	48	73	32	2.1	18	63	93	50	5.5	45				
RS08B-1B48T	198	194.18	18	1.5	18	48	73	32	2.3	18	63	93	50	6.1	48				
RS08B-1B50T	206	202.26	18	1.7	18	48	73	32	2.5	18	63	93	50	6.7	50				
RS08B-1B54T	223	218.42	18	2.0	18	48	73	32	2.8	18	63	93	50	7.4	54				
RS08B-1B60T	247	242.66	18	2.4	18	48	73	32	3.2	18	63	93	50	8.9	60				

- Note: 1. Maximum bore diameters shown are standard figures. Decide and confirm bore diameters and key surface pressures based on standard machinery design.
 2. Models shaded in the chart above are hardened.
 3. Items not hardened as standard are available as made-to-order.
 4. The outer diameters shown above are for 1B Type. The outer diameters for some other models may differ.
 5. Items marked with an * above have a groove around the periphery of the hub (see diagram at right). The groove outer diameter is 9T: 21, 10T: 25, 11T: 30, and 13T: 32.
 6. Welded specifications: Use carbon steel for machine structural use (teeth) and rolled steel for general structural use (hub)
 7. The dimensions shown in this catalog are nominal dimensions and differ from actual dimensions.

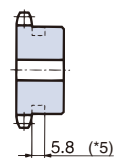

RS Roller Chain BS/DIN Sprockets

RS10B

Model Numbering Example

RS10B -1B 9T Q

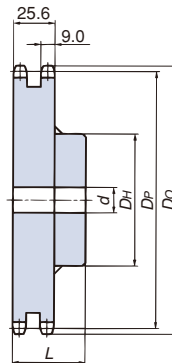
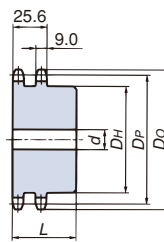
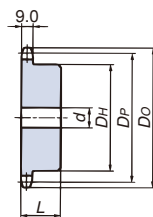
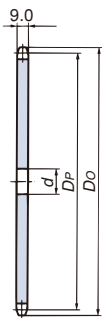
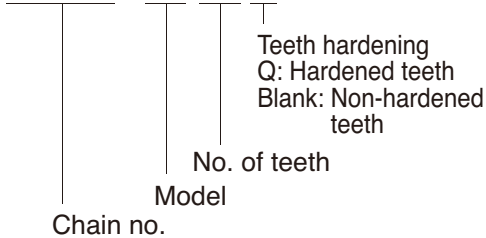

Model Number	Outer Dia. (4) Do	Pitch Dia. Dp	1A Type			1B Type						2B Type						No. of Teeth				
			Pilot Bore d	Approx. mass kg	Construction/ material	Bore dia. d		Hub		Approx. mass kg	Construction/ material	Bore dia. d		Hub		Approx. mass kg	Construction/ material					
						Pilot bore	Max.	Dia. DH	Total length L			Pilot bore	Max.	Dia. DH	Total length L							
RS10B-1B9TQ	52	46.42				9.53	19.22	34	25	0.20	*										9	
RS10B-1B10TQ	57	51.37				9.53	25	40	25	0.27	*											10
RS10B-1B11TQ	62	56.35				12.7	30	45	25	0.33	*											11
RS10B-1B12TQ	67	61.34	18	0.18		12.7	32	50	25	0.41	*	12.7	24	42	40	0.6						12
RS10B-1B13TQ	72	66.33	18	0.22		12.7	32	51	25	0.46	*	12.7	28.5	47	40	0.7						13
RS10B-1B14TQ	77	71.34	18	0.24		12.7	35	52	25	0.52	(*5)	12.7	32	52	40	0.9						14
RS10B-1B15TQ	82	76.35	18	0.27		12.7	40	57	25	0.62		12.7	35	57	40	1.0						15
RS10B-1B16TQ	87	81.37	18	0.31		12.7	45.5	62	25	0.72		12.7	40	62	45	1.3						16
RS10B-1B17TQ	92	86.39	18	0.35		12.7	47.5	67	25	0.83		12.7	47.5	67	45	1.5						17
RS10B-1B18TQ	97	91.42	18	0.40		12.7	47.5	72	28	1.0		12.7	47.5	72	45	1.7						18
RS10B-1B19TQ	103	96.45	18	0.44		12.7	47.5	73	28	1.1		15.88	52	79	45	2.0						19
RS10B-1B20TQ	108	101.48	18	0.49		12.7	47.5	73	28	1.2		15.88	55	82	45	2.2						20
RS10B-1B21TQ	113	106.51	18	0.54		15.88	47.5	73	28	1.2		15.88	60	89	45	2.5						21
RS10B-1B22TQ	118	111.55	18	0.60		15.88	47.5	73	28	1.3		15.88	63	92	50	2.9						22
RS10B-1B23TQ	123	116.59	18	0.66		15.88	47.5	73	28	1.3		15.88	67	99	50	3.3						23
RS10B-1B24TQ	128	121.62	18	0.71		15.88	47.5	73	28	1.4		15.88	70	102	50	3.6						24
RS10B-1B25TQ	133	126.66	18	0.78		15.88	47.5	73	28	1.5		15.88	75	109	50	4.0						25
RS10B-1B26TQ	138	131.70	18	0.84		18	48	73	28	1.5		18	63	93	50	3.7						26
RS10B-1B27TQ	143	136.74	18	0.91		18	48	73	28	1.5		18	63	93	50	3.9						27
RS10B-1B28TQ	148	141.79	18	0.98		18	48	73	28	1.6		18	63	93	50	4.1						28
RS10B-1B30TQ	158	151.87	18	1.1		18	48	73	28	1.8		18	63	93	50	4.6						30
RS10B-1B32TQ	168	161.96	18	1.3		18	48	73	28	1.9		18	63	93	50	5.1						32
RS10B-1B34TQ	178	172.05	18	1.4		18	48	73	28	2.1		18	63	93	50	5.6						34
RS10B-1B35TQ	183	177.10	18	1.5		18	48	73	28	2.2		18	63	93	50	5.9						35
RS10B-1B36T	188	182.15	23	1.6		23	55	83	35	2.7		18	63	93	50	6.2						36
RS10B-1B38T	198	192.24	23	1.8		23	55	83	35	2.9		18	63	93	50	6.8						38
RS10B-1B40T	208	202.33	23	2.0		23	55	83	35	3.1		23	66	98	56	7.8						40
RS10B-1B42T	218	212.43	23	2.2		23	55	83	35	3.3		23	66	98	56	8.5						42
RS10B-1B45T	234	227.58	23	2.5		23	55	83	35	3.6		23	66	98	56	9.5						45
RS10B-1B48T	249	242.73	23	2.9		23	55	83	35	4.0		23	66	98	56	10.7						48
RS10B-1B50T	259	252.82	23	3.1		23	55	83	35	4.3		23	66	98	56	11.5						50
RS10B-1B54T	279	273.03	23	3.6		23	55	83	35	4.8		23	66	98	56	13.5						54
RS10B-1B60T	309	303.33	23	4.6		23	55	83	35	5.6		23	66	98	56	16.3						60

- Note: 1. Maximum bore diameters shown are standard figures. Decide and confirm bore diameters and key surface pressures based on standard machinery design.
 2. Models shaded in the chart above are hardened.
 3. Items not hardened as standard are available as made-to-order.
 4. The outer diameters shown above are for 1B Type. The outer diameters for some other models may differ.
 5. Items marked with an * above have a groove around the periphery of the hub (see diagram at right). The groove outer diameter is 9T: 27, 10T: 32, 11T: 37, 12T: 42, and 13T: 47.
 6. Welded specifications: Use carbon steel for machine structural use (teeth) and rolled steel for general structural use (hub)
 7. The dimensions shown in this catalog are nominal dimensions and differ from actual dimensions.

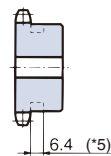

RS Roller Chain BS/DIN Sprockets

RS12B

Model Numbering Example

RS12B -1B 9T Q

Teeth hardening
Q: Hardened teeth
Blank: Non-hardened teeth

No. of teeth

Model

Chain no.

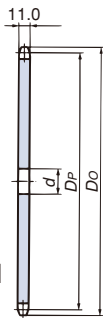

1A Type

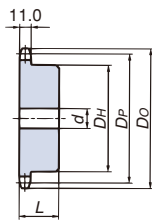

(Machined specifications) 1B type

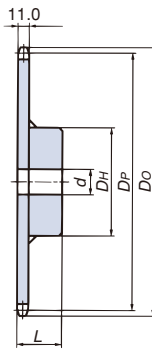

(Welded specifications)

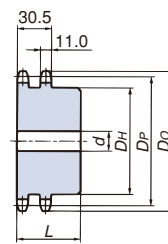

(Machined specifications) 2B type

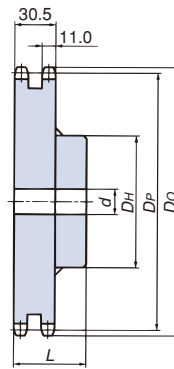

(Welded specifications)

Model Number	Outer Dia. ^(*) Do	Pitch Dia. DP	1A Type			1B Type					2B Type					No. of Teeth		
			Pilot Bore d	Approx. mass kg	Construction/ material	Bore dia. d		Hub		Approx. mass kg	Construction/ material	Bore dia. d		Hub			Approx. mass kg	Construction/ material
						Pilot bore	Max.	Dia. DH	Total length L			Pilot bore	Max.	Dia. DH	Total length L			
RS12B-1B9TQ	63	55.70				9.53	24.5	43	32	0.40	※							9
RS12B-1B10TQ	69	61.65				12.7	30	49	32	0.49	※							10
RS12B-1B11TQ	75	67.62				12.7	32	51	32	0.60	※							11
RS12B-1B12TQ	81	73.60	18	0.37		12.7	32	51	32	0.69	(*)	12.7	32	51	50	1.1		12
RS12B-1B13TQ	87	79.60	18	0.42		15.88	35	57	32	0.81		15.88	35	57	50	1.3		13
RS12B-1B14TQ	93	85.61	18	0.48		15.88	39.5	62	32	1.0		15.88	39.5	62	56	1.7		14
RS12B-1B15TQ	99	91.63	18	0.56		15.88	45.5	68	32	1.1		15.88	45.5	68	56	2.0		15
RS12B-1B16TQ	105	97.65	18	0.64		15.88	47.5	73	32	1.3		15.88	50	76	56	2.4		16
RS12B-1B17TQ	111	103.67	18	0.72		15.88	47.5	73	32	1.4		15.88	55	82	56	2.8		17
RS12B-1B18TQ	117	109.70	18	0.81		15.88	55	83	40	2.0		15.88	59	87	56	3.1		18
RS12B-1B19TQ	123	115.74	18	0.90		15.88	55	83	40	2.1		15.88	63	95	56	3.6		19
RS12B-1B20TQ	129	121.78	18	1.0		15.88	55	83	40	2.2		15.88	69	101	56	4.1		20
RS12B-1B21TQ	135	127.82	18	1.1		15.88	55	83	40	2.3		15.88	75	107	56	4.5		21
RS12B-1B22TQ	141	133.86	18	1.2		15.88	55	83	40	2.5		15.88	78	113	56	5.0		22
RS12B-1B23TQ	147	139.90	18	1.3		18	55	83	40	2.5		18	66	98	56	4.9		23
RS12B-1B24TQ	153	145.95	18	1.4		18	55	83	40	2.6		18	66	98	56	5.2		24
RS12B-1B25TQ	159	151.99	18	1.6		18	55	83	40	2.7		18	66	98	56	5.6		25
RS12B-1B26TQ	165	158.04	18	1.7		18	55	83	40	2.9		18	66	98	56	6.0		26
RS12B-1B27TQ	171	164.09	18	1.8		18	55	83	40	3.0		18	66	98	56	6.3		27
RS12B-1B28TQ	178	170.14	18	1.9		18	55	83	40	3.1		18	66	98	56	6.8		28
RS12B-1B30TQ	190	182.25	18	2.3		18	55	83	40	3.4		18	66	98	56	7.6		30
RS12B-1B32T	202	194.35	18	2.6		18	55	83	40	3.7		18	66	98	56	8.5		32
RS12B-1B34T	214	206.46	18	2.8		18	55	83	40	4.0		18	66	98	56	9.5		34
RS12B-1B35T	220	212.52	18	3.1		18	55	83	40	4.2		18	66	98	56	10.0		35
RS12B-1B36T	226	218.57	18	3.3		18	55	83	40	4.4		18	66	98	56	10.6		36
RS12B-1B38T	238	230.69	18	3.6		18	55	83	40	4.8		18	66	98	56	11.7		38
RS12B-1B40T	250	242.80	18	4.0		18	55	83	40	5.1		18	66	98	56	12.8		40
RS12B-1B42T	262	254.92	23	4.3		23	63	93	45	6.0		23	75	107	71	15.2		42
RS12B-1B45T	280	273.09	23	5.1		23	63	93	45	6.7		23	75	107	71	17.2		45
RS12B-1B48T	299	291.27	23	5.8		23	63	93	45	7.4		23	75	107	71	19.3		48
RS12B-1B50T	311	303.39	23	6.3		23	63	93	45	8.0		23	75	107	71	20.8		50
RS12B-1B54T	335	327.63	23	7.4		23	63	93	45	8.9		23	75	107	71	23.9		54
RS12B-1B60T	371	363.99	23	9.1		23	63	93	45	10.6		23	75	107	71	29.1		60

- Note: 1. Maximum bore diameters shown are standard figures. Decide and confirm bore diameters and key surface pressures based on standard machinery design.
 2. Models shaded in the chart above are hardened.
 3. Items not hardened as standard are available as made-to-order.
 4. The outer diameters shown above are for 1B Type.
 The outer diameters for some other models may differ.
 5. Items marked with an * above have a groove around the periphery of the hub (see diagram at right).
 The groove outer diameter is 9T: 32, 10T: 37, and 11T: 45.
 6. Welded specifications: Use carbon steel for machine structural use (teeth) and rolled steel for general structural use (hub)
 7. Models with approximate masses in bold have one hanging hole processed.
 See the diagram on the right for information.
 8. The dimensions shown in this catalog are nominal dimensions and differ from actual dimensions.

Hanging Hole Dimensions

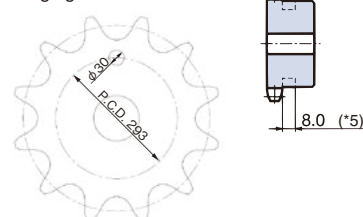

The phase relationship between the hanging hole and teeth may vary.

RS Roller Chain BS/DIN Sprockets

RS16B

Model Numbering Example
RS16B -1B 9T Q

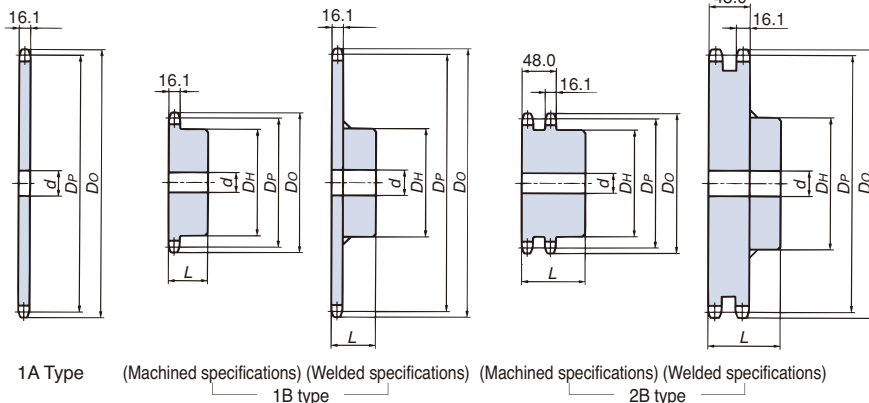
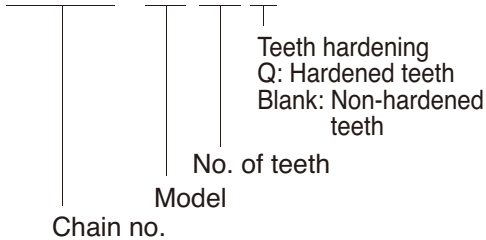

Model Number	Outer Dia. ^(*) D _o	Pitch Dia. D _p	1A Type		1B Type					2B Type					No. of Teeth			
			Pilot Bore d	Approx. mass kg	Bore dia. d		Hub		Approx. mass kg	Construction/ material	Bore dia. d		Hub			Approx. mass kg	Construction/ material	
					Pilot bore	Max.	Dia. D _h	Total length L			Pilot bore	Max.	Dia. D _h	Total length L				
RS16B-1B9TQ	84	74.26			15.9	34	57	40	0.87	※							9	
RS16B-1B10TQ	92	82.20			15.9	32	52	40	0.97								10	
RS16B-1B11TQ	100	90.16			15.9	38	60	40	1.2								11	
RS16B-1B12TQ	108	98.14	23	0.82	19.05	45	67	40	1.5		19.05	46	67	63	2.5	Machined specifications Carbon steel for machine structural use	12	
RS16B-1B13TQ	116	106.14	23	0.93	19.05	50	77	40	1.9	(*)5	19.05	50	77	63	3.1		13	
RS16B-1B14TQ	124	114.15	23	1.1	19.05	50	77	40	2.0		19.05	58	86	63	3.7		14	
RS16B-1B15TQ	132	122.17	23	1.2	19.05	63	93	40	2.6		19.05	64	94	63	4.3		15	
RS16B-1B16TQ	140	130.20	23	1.4	19.05	63	93	40	2.8		19.05	70	102	71	5.5		16	
RS16B-1B17TQ	148	138.23	23	1.6	19.05	63	93	40	3.0		19.05	76	110	71	6.4		17	
RS16B-1B18TQ	156	146.27	23	1.8	19.05	63	93	40	3.2		23	66	98	71	6.4		18	
RS16B-1B19TQ	164	154.32	23	2.0	23	63	93	40	3.4	Machined specifications Carbon steel for machine structural use	23	66	98	71	7.0		19	
RS16B-1B20TQ	172	162.37	23	2.2	23	63	93	40	3.6		23	75	107	71	7.9		20	
RS16B-1B21TQ	180	170.42	23	2.5	23	63	93	40	3.8		23	75	107	71	8.6		21	
RS16B-1B22T	188	178.48	28	2.7	28	75	107	45	4.8		28	80	117	71	9.6		22	
RS16B-1B23T	196	186.54	28	2.9	28	75	107	45	5.1		28	80	117	71	10.3		23	
RS16B-1B24T	205	194.60	28	3.2	28	75	107	45	5.4		Welded specifications	28	80	117	80		11.8	24
RS16B-1B25T	213	202.66	28	3.5	28	75	107	45	5.6			28	80	117	80		12.6	25
RS16B-1B26T	221	210.72	28	3.8	28	75	107	45	5.9			28	80	117	80		13.5	26
RS16B-1B27T	229	218.79	28	4.0	28	75	107	45	6.1			28	80	117	80		14.4	27
RS16B-1B28T	237	226.86	28	4.3	28	75	107	45	6.5			28	80	117	80		15.3	28
RS16B-1B30T	253	243.00	28	5.0	28	75	107	45	7.1	28		80	117	80	17.2		30	
RS16B-1B32T	269	259.14	28	5.8	28	75	107	45	7.8	28		80	117	80	19.3	32		
RS16B-1B34T	285	275.28	28	6.4	28	75	107	45	8.5	28		80	117	80	21.5	34		
RS16B-1B35T	293	283.36	28	6.9	28	75	107	45	8.9	28		80	117	80	22.7	35		
RS16B-1B36T	301	291.43	33	7.3	33	80	117	50	10.1	28		80	117	80	23.9	36		
RS16B-1B38T	318	307.58	33	8.0	33	80	117	50	10.9	Welded specifications	28	80	117	80	26.4	38		
RS16B-1B40T	334	323.74	33	9.0	33	80	117	50	11.8		33	89	127	90	30.4	40		
RS16B-1B42T	350	339.89	33	9.8	33	80	117	50	12.7		33	89	127	90	33.2	42		
RS16B-1B45T	374	364.12	33	11.0	33	80	117	50	14.2		33	89	127	90	37.6	45		
RS16B-1B48T	398	388.36	33	13.0	33	80	117	50	15.8		33	89	127	90	42.3	48		
RS16B-1B50T	414	404.52	33	14.0	33	80	117	50	16.8		33	89	127	90	45.7	50		
RS16B-1B54T	447	436.84	33	16.0	33	80	117	50	19.2		33	89	127	90	52.8	54		
RS16B-1B60T	495	485.33	33	20.0	33	80	117	50	23.1		33	89	127	90	64.5	60		

- Note: 1. Maximum bore diameters shown are standard figures.
Decide and confirm bore diameters and key surface pressures based on standard machinery design.
2. Models shaded in the chart above are hardened.
3. Items not hardened as standard are available as made-to-order.
4. The outer diameters shown above are for 1B Type.
The outer diameters for some other models may differ.
5. Items marked with an * above have a groove around the periphery of the hub (see diagram at right).
The groove outer diameter is 9T: 44.
6. Welded specifications: Use carbon steel for machine structural use (teeth) and rolled steel for general structural use (hub)
7. Models with approximate masses in bold have one hanging hole processed. See the diagram on the right for information.
8. The dimensions shown in this catalog are nominal dimensions and differ from actual dimensions.

Hanging Hole Dimensions

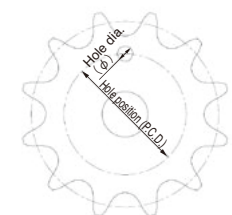

No. of teeth	2B/2C Type hole dia. (φ30) Hole position (P.C.D.)
40	242
42	258
45	283
48	307
50	323
54	355
60	404

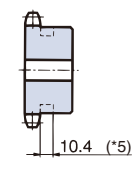

The phase relationship between the hanging hole and teeth may vary.

Before Use
Standard Roller Chains
Lube-Free Roller Chains
Heavy Duty Roller Chains
Corrosion Resistant Roller Chains
Specialty Roller Chains
Sprockets
Pin Gear Drives
Accessories
Selection
Handling

RS Sprocket Stainless Steel Type



■ Stainless Steel Type

Uses stainless steel for superb corrosion resistance. Also highly resistant to high and low temperatures for use in special environments.

Available sizes: RS11 – RS80
Hub type: 1B (single hub) (1B or 1C for RS11 only)

■ Model Numbering Example

RS35-1B 13T-SS

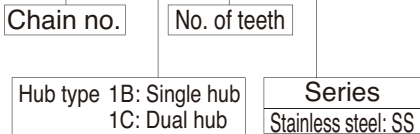

■ RS11 1B Type

Available chain pitch: 3.7465mm Roller dia. 2.285mm

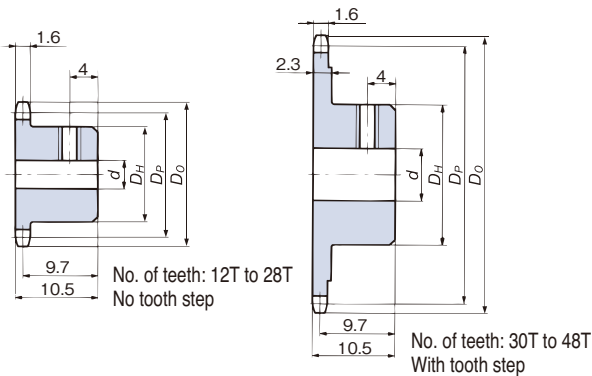

■ RS11 1C Type

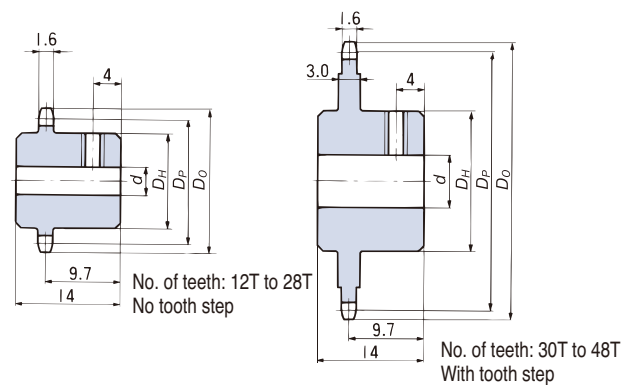

(Be aware that no set screws are provided.)

Model Number	No. of Teeth	Pitch Dia. D_p	Outer Dia. (D_o)	Bore dia. d		Hub dia. D_H	Set Screw Hole	1B Approx. mass (g)	1C Approx. mass (g)
				Pilot bore	Max.				
RS11-1 ■ 12T-SS	12	14.475	16.2	4	6	9.4	M3×0.5	5.9	7.4
RS11-1 ■ 15T-SS	15	18.020	19.9	4	9	13		11.5	14.7
RS11-1 ■ 16T-SS	16	19.204	21.1	4	9	14		13.5	17.3
RS11-1 ■ 18T-SS	18	21.575	23.5	4	11	16		17.7	22.8
RS11-1 ■ 20T-SS	20	23.949	25.9	6	13	19		23.3	30.8
RS11-1 ■ 24T-SS	24	28.703	30.7	6	13	19		25.7	32.7
RS11-1 ■ 28T-SS	28	33.462	35.5	6	13	19	28.7	35.7	
RS11-1 ■ 30T-SS	30	35.842	37.9	6	13	19	M4×0.7	29.7	39.3
RS11-1 ■ 34T-SS	34	40.604	42.7	6	13	19		37.9	48.9
RS11-1 ■ 36T-SS	36	42.986	45.1	6	13	19		40.7	52.4
RS11-1 ■ 40T-SS	40	47.751	49.8	6	13	19		46.5	59.9
RS11-1 ■ 48T-SS	48	57.283	59.4	6	13	19		60.5	77.8

Material/Specifications Machined stainless steel

■ Indicate type (B or C) in the ■ in the table above. Contact a Tsubaki representative regarding number of teeth other than those above.

All items stocked. Note: 1. Max. bore diameter shown is for general situations. Decide and confirm bore diameters and key surface pressures based on standard machinery design.
2. The dimensions shown in this catalog are nominal dimensions and differ from actual dimensions.

Before Use
Standard Roller Chains
Lube-Free Roller Chains
Heavy Duty Roller Chains
Corrosion Resistant Roller Chains
Specialty Roller Chains
Sprockets
Pin Gear Drives
Accessories
Handling

RS Sprocket Stainless Steel Type

RS25 1B Type

Applicable chain pitch: 6.35mm Roller dia.: 3.3mm

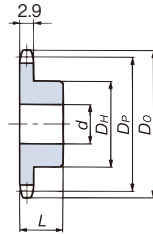

RS35 1B Type

Applicable chain pitch: 9.525mm Roller dia.: 5.08mm

Hub with groove (10T – 13T)

Hub without groove (14T and over)

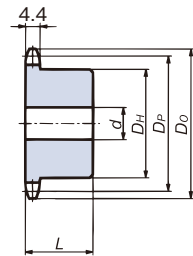
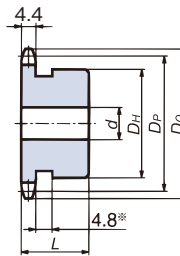

No. of teeth	Hub dia.	Groove dia.
10T	φ 25	φ 18
11T	φ 27	φ 22
12T	φ 31	φ 24
13T	φ 32	φ 28

*The groove is provided on the hub perimeter to prevent sprocket – chain interference.

RS25 1B Type with stainless steel pilot bore

Model No.	No. of Teeth	Pitch Circle Dia. DP	(Outer Dia.) DO	Bore Dia. d		Hub Dia.		Approx. Mass (kg)
				Pilot bore	Max.	Pilot bore DH	Max. L	
RS25-1B10T-SS	10	20.55	23	6	9	14	15	0.02
RS25-1B11T-SS	11	22.54	25	6	10	16	15	0.03
RS25-1B12T-SS	12	24.53	28	6	11	18	15	0.04
RS25-1B13T-SS	13	26.53	30	6	12	20	15	0.05
RS25-1B14T-SS	14	28.54	32	6	12	20	15	0.06
RS25-1B15T-SS	15	30.54	34	6	12	20	20	0.07
RS25-1B16T-SS	16	32.55	36	8	15	25	20	0.08
RS25-1B17T-SS	17	34.56	38	8	15	25	20	0.09
RS25-1B18T-SS	18	36.57	40	8	15	25	20	0.10
RS25-1B19T-SS	19	38.58	42	8	15	25	20	0.10
RS25-1B20T-SS	20	40.59	44	8	15	25	20	0.10
RS25-1B21T-SS	21	42.61	46	10	18	30	20	0.12
RS25-1B22T-SS	22	44.62	48	10	18	30	20	0.13
RS25-1B23T-SS	23	46.63	50	10	18	30	20	0.13
RS25-1B24T-SS	24	48.65	52	10	21	35	20	0.15
RS25-1B25T-SS	25	50.66	54	10	21	35	20	0.16
RS25-1B26T-SS	26	52.68	56	10	25	40	20	0.17
RS25-1B27T-SS	27	54.70	58	10	25	40	20	0.20
RS25-1B28T-SS	28	56.71	60	10	25	40	20	0.21
RS25-1B30T-SS	30	60.75	64	12	28	45	20	0.23
RS25-1B32T-SS	32	64.78	68	12	31	50	20	0.40
RS25-1B34T-SS	34	68.82	72	12	31	50	20	0.41
RS25-1B35T-SS	35	70.84	74	12	31	50	20	0.41
RS25-1B36T-SS	36	72.86	76	12	31	50	20	0.42
RS25-1B38T-SS	38	76.90	80	12	31	50	22	0.43
RS25-1B40T-SS	40	80.93	84	12	31	50	22	0.45

Material/Specifications Machined stainless steel

Contact a Tsubaki representative regarding numbers of teeth other than those above.

RS35 1B Type with stainless steel pilot bore

Model No.	No. of Teeth	Pitch Circle Dia. DP	(Outer Dia.) DO	Bore Dia. d		Hub Dia.		Approx. Mass (kg)
				Pilot bore	Max.	Pilot bore DH	Max. L	
RS35-1B10T-SS	10	30.82	35	8	12	25	20	0.08
RS35-1B11T-SS	11	33.81	38	8	14	27	20	0.09
RS35-1B12T-SS	12	36.80	41	8	16.5	31	20	0.12
RS35-1B13T-SS	13	39.80	44	9.5	18	32	20	0.12
RS35-1B14T-SS	14	42.80	47	9.5	16.5	30	20	0.12
RS35-1B15T-SS	15	45.81	51	9.5	19	35	20	0.16
RS35-1B16T-SS	16	48.82	54	9.5	20	37	20	0.19
RS35-1B17T-SS	17	51.84	57	9.5	24	41	20	0.22
RS35-1B18T-SS	18	54.85	60	9.5	24.5	44	20	0.25
RS35-1B19T-SS	19	57.87	63	9.5	28.5	47	20	0.28
RS35-1B20T-SS	20	60.89	66	9.5	30	50	20	0.32
RS35-1B21T-SS	21	63.91	69	9.5	32	53	20	0.36
RS35-1B22T-SS	22	66.93	72	9.5	32	53	20	0.37
RS35-1B23T-SS	23	69.95	75	9.5	32	53	20	0.40
RS35-1B24T-SS	24	72.97	78	9.5	32	53	22	0.43
RS35-1B25T-SS	25	76.00	81	12.7	32	53	22	0.44
RS35-1B26T-SS	26	79.02	84	12.7	32	53	22	0.45
RS35-1B27T-SS	27	82.05	87	12.7	32	53	22	0.46
RS35-1B28T-SS	28	85.07	90	12.7	32	53	22	0.48
RS35-1B30T-SS	30	91.12	96	12.7	32	53	22	0.51
RS35-1B32T-SS	32	97.18	102	12.7	32	53	22	0.54
RS35-1B34T-SS	34	103.23	109	12.7	32	53	22	0.57
RS35-1B35T-SS	35	106.26	112	12.7	32	53	22	0.59
RS35-1B36T-SS	36	109.29	115	12.7	32	53	22	0.61
RS35-1B38T-SS	38	115.34	121	13	42	63	25	0.82
RS35-1B40T-SS	40	121.40	127	13	42	63	25	0.85

Material/Specifications Machined stainless steel

Contact a Tsubaki representative regarding numbers of teeth other than those above.

All items stocked. Note: The dimensions shown in this catalog are nominal dimensions and differ from actual dimensions.

RS Sprocket Stainless Steel Type

RS40 1B Type

Applicable chain pitch: 12.70mm Roller dia.: 7.92mm

Hub with groove (10T – 12T)

Hub without groove (13T and over)

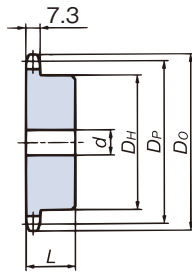
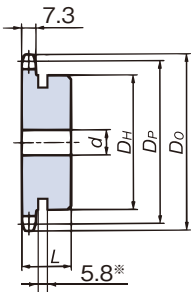

No. of teeth	Hub dia.	Groove dia.
10T	φ 32	φ 25
11T	φ 37	φ 30
12T	φ 40	φ 32

RS50 1B Type

Applicable chain pitch: 15.875mm Roller dia.: 10.16mm

Hub with groove (10T – 13T)

Hub without groove (14T – 40T)

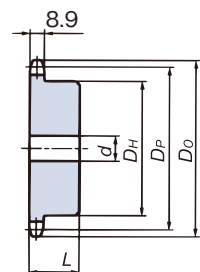
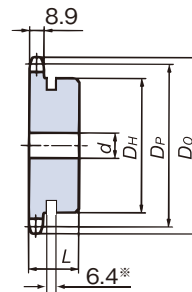

No. of teeth	Hub dia.	Groove dia.
10T	φ 40	φ 32
11T	φ 46	φ 37
12T	φ 51	φ 42
13T	φ 51	φ 47

*The groove is provided on the hub perimeter to prevent sprocket – chain interference.

*The groove is provided on the hub perimeter to prevent sprocket – chain interference.

RS40 1B Type with stainless steel pilot bore

Model No.	No. of Teeth	Pitch Circle Dia. DP	Outer Dia. (DO)	Bore Dia. d		Hub Dia.		Approx. Mass (kg)
				Pilot bore	Max.	Pilot bore DH	Max. L	
RS40-1B10T-SS	10	41.10	47	9.5	16.5	32	22	0.14
RS40-1B11T-SS	11	45.08	51	9.5	20	37	22	0.19
RS40-1B12T-SS	12	49.07	55	9.5	22	40	22	0.22
RS40-1B13T-SS	13	53.07	59	9.5	20	37	22	0.23
RS40-1B14T-SS	14	57.07	63	9.5	24	42	22	0.28
RS40-1B15T-SS	15	61.08	67	9.5	28.5	46	22	0.34
RS40-1B16T-SS	16	65.10	71	12.7	30	50	22	0.40
RS40-1B17T-SS	17	69.12	76	12.7	32	54	22	0.46
RS40-1B18T-SS	18	73.14	80	12.7	35	57	22	0.51
RS40-1B19T-SS	19	77.16	84	12.7	39.5	62	22	0.59
RS40-1B20T-SS	20	81.18	88	12.7	45.5	67	25	0.76
RS40-1B21T-SS	21	85.21	92	12.7	45.5	71	25	0.85
RS40-1B22T-SS	22	89.24	96	12.7	50	75	25	0.95
RS40-1B23T-SS	23	93.27	100	12.7	50	77	25	1.0
RS40-1B24T-SS	24	97.30	104	12.7	42	63	25	0.84
RS40-1B25T-SS	25	101.33	108	12.7	42	63	25	0.88
RS40-1B26T-SS	26	105.36	112	12.7	42	63	25	0.92
RS40-1B27T-SS	27	109.40	116	12.7	42	63	25	0.96
RS40-1B28T-SS	28	113.43	120	12.7	42	63	25	1.0
RS40-1B30T-SS	30	121.50	128	12.7	42	63	25	1.1
RS40-1B32T-SS	32	129.57	137	16	45	68	28	1.3
RS40-1B34T-SS	34	137.64	145	16	45	68	28	1.3
RS40-1B35T-SS	35	141.68	149	16	45	68	28	1.4
RS40-1B36T-SS	36	145.72	153	16	45	68	28	1.4
RS40-1B38T-SS	38	153.79	161	16	45	68	28	1.5
RS40-1B40T-SS	40	161.87	169	16	45	68	28	1.6

Material/Specifications: Machined stainless steel

Contact a Tsubaki representative regarding numbers of teeth other than those above.

RS50 1B Type with stainless steel pilot bore

Model No.	No. of Teeth	Pitch Circle Dia. DP	Outer Dia. (DO)	Bore Dia. d		Hub Dia.		Approx. Mass (kg)
				Pilot bore	Max.	Pilot bore DH	Max. L	
RS50-1B10T-SS	10	51.37	58	9.5	22	40	25	0.27
RS50-1B11T-SS	11	56.35	64	12.7	25	46	25	0.33
RS50-1B12T-SS	12	61.34	69	12.7	32	51	25	0.41
RS50-1B13T-SS	13	66.33	74	12.7	32	51	25	0.46
RS50-1B14T-SS	14	71.34	79	12.7	32	52	25	0.52
RS50-1B15T-SS	15	76.35	84	12.7	35	57	25	0.62
RS50-1B16T-SS	16	81.37	89	12.7	40	62	25	0.72
RS50-1B17T-SS	17	86.39	94	12.7	45.5	67	25	0.83
RS50-1B18T-SS	18	91.42	100	12.7	47.5	72	28	1.0
RS50-1B19T-SS	19	96.45	105	12.7	47.5	73	28	1.1
RS50-1B20T-SS	20	101.48	110	12.7	47.5	73	28	1.2
RS50-1B21T-SS	21	106.51	115	15.9	47.5	73	28	1.2
RS50-1B22T-SS	22	111.55	120	15.9	47.5	73	28	1.3
RS50-1B23T-SS	23	116.59	125	15.9	47.5	73	28	1.3
RS50-1B24T-SS	24	121.62	130	15.9	47.5	73	28	1.4
RS50-1B25T-SS	25	126.66	135	15.9	47.5	73	28	1.5
RS50-1B26T-SS	26	131.70	140	18	48	73	28	1.5
RS50-1B27T-SS	27	136.74	145	18	48	73	28	1.5
RS50-1B28T-SS	28	141.79	150	18	48	73	28	1.6
RS50-1B30T-SS	30	151.87	161	18	48	73	28	1.8
RS50-1B32T-SS	32	161.96	171	18	48	73	28	1.9
RS50-1B34T-SS	34	172.05	181	18	48	73	28	2.1
RS50-1B35T-SS	35	177.10	186	18	48	73	28	2.2
RS50-1B36T-SS	36	182.15	191	23	55	83	35	2.7
RS50-1B38T-SS	38	192.24	201	23	55	83	35	2.9
RS50-1B40T-SS	40	202.33	211	23	55	83	35	3.1

Material/Specifications: Machined stainless steel

Contact a Tsubaki representative regarding numbers of teeth other than those above.

All items stocked. Note: The dimensions shown in this catalog are nominal dimensions and differ from actual dimensions.

Before Use | Standard Roller Chains | Lube-Free Roller Chains | Heavy Duty Roller Chains | Corrosion Resistant Roller Chains | Specialty Roller Chains | Sprockets | Pin Gear Drives | Accessories | Selection | Handling

RS Sprocket Stainless Steel Type

RS60 1B Type

Applicable chain pitch: 19.05mm Roller dia.: 11.91mm

Hub with groove (10T – 11T)

Hub without groove (12T – 30T)

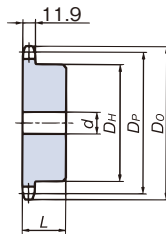
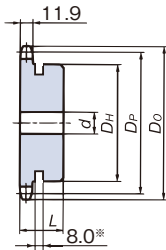

No. of teeth	Hub dia.	Groove dia.
10T	φ 49	φ 37
11T	φ 51	φ 45

*The groove is provided on the hub perimeter to prevent sprocket – chain interference.

RS80 1B Type

Applicable chain pitch: 25.40mm Roller dia.: 15.88mm

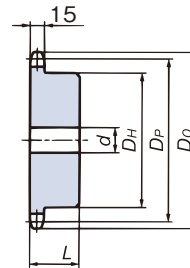

RS60 1B Type with stainless steel pilot bore

Model No.	No. of Teeth	Pitch Circle Dia. D_P	(Outer Dia.) (D_o)	Bore Dia. d		Hub Dia.		Approx. Mass (kg)
				Pilot bore	Max.	Pilot bore D_H	Max. L	
RS60-1B10T-SS	10	61.65	70	12.7	30	49	32	0.49
RS60-1B11T-SS	11	67.62	76	12.7	32	51	32	0.60
RS60-1B12T-SS	12	73.60	83	12.7	32	51	32	0.69
RS60-1B13T-SS	13	79.60	89	15.9	35	57	32	0.81
RS60-1B14T-SS	14	85.61	95	15.9	39.5	62	32	0.96
RS60-1B15T-SS	15	91.63	101	15.9	45.5	68	32	1.1
RS60-1B16T-SS	16	97.65	107	15.9	47.5	73	32	1.3
RS60-1B17T-SS	17	103.67	113	15.9	47.5	73	32	1.4
RS60-1B18T-SS	18	109.70	119	15.9	55	83	40	2.0
RS60-1B19T-SS	19	115.74	126	15.9	55	83	40	2.1
RS60-1B20T-SS	20	121.78	132	15.9	55	83	40	2.2
RS60-1B21T-SS	21	127.82	138	15.9	55	83	40	2.3
RS60-1B22T-SS	22	133.86	144	15.9	55	83	40	2.5
RS60-1B23T-SS	23	139.90	150	18	55	83	40	2.5
RS60-1B24T-SS	24	145.95	156	18	55	83	40	2.6
RS60-1B25T-SS	25	151.99	162	18	55	83	40	2.7
RS60-1B26T-SS	26	158.04	168	18	55	83	40	2.9
RS60-1B27T-SS	27	164.09	174	18	55	83	40	3.0
RS60-1B28T-SS	28	170.14	180	18	55	83	40	3.1
RS60-1B30T-SS	30	182.25	193	18	55	83	40	3.4

Material/Specifications Machined stainless steel

Contact a Tsubaki representative regarding numbers of teeth other than those above.

All items stocked.

Note: The dimensions shown in this catalog are nominal dimensions and differ from actual dimensions.

RS80 1B Type with stainless steel pilot bore

Model No.	No. of Teeth	Pitch Circle Dia. D_P	(Outer Dia.) (D_o)	Bore Dia. d		Hub Dia.		Approx. Mass (kg)
				Pilot bore	Max.	Pilot bore D_H	Max. L	
RS80-1B10T-SS	10	82.20	93	15.9	32	52	40	0.97
RS80-1B11T-SS	11	90.16	102	15.9	38	60	40	1.2
RS80-1B12T-SS	12	98.14	110	19	45	67	40	1.5
RS80-1B13T-SS	13	106.14	118	19	50	77	40	1.9
RS80-1B14T-SS	14	114.15	127	19	50	77	40	2.0
RS80-1B15T-SS	15	122.17	135	19	63	93	40	2.6
RS80-1B16T-SS	16	130.20	143	19	63	93	40	2.8
RS80-1B17T-SS	17	138.23	151	19	63	93	40	3.0
RS80-1B18T-SS	18	146.27	159	19	63	93	40	3.2
RS80-1B19T-SS	19	154.32	167	23	63	93	40	3.4
RS80-1B20T-SS	20	162.37	176	23	63	93	40	3.6
RS80-1B21T-SS	21	170.42	184	23	63	93	40	3.8
RS80-1B22T-SS	22	178.48	192	28	75	107	45	4.8
RS80-1B23T-SS	23	186.54	200	28	75	107	45	5.1
RS80-1B24T-SS	24	194.60	208	28	75	107	45	5.4
RS80-1B25T-SS	25	202.66	216	28	75	107	45	5.6

Material/Specifications Machined stainless steel

Contact a Tsubaki representative regarding numbers of teeth other than those above.

Engineering Plastic Sprockets

Engineering Plastic Type

Uses a special MC901 nylon plastic (dark blue). Allows for lube-free operation. (Chain speed less than 70m/min recommended, can be used up to 150m/min in lubricated conditions.)

Available chain sizes: RS35 to RS60
Hub model: 1B Type



RS35

Hub with groove (13T)

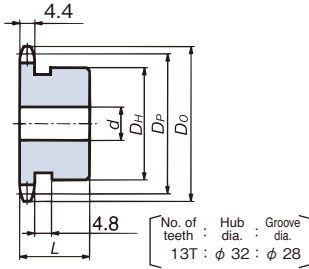

Hub without groove (14T and over)

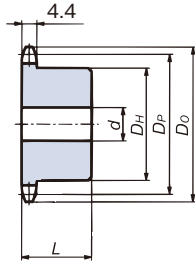

Model No.	No. of Teeth	Allowable Transmission Torque N · m	Pitch Circle Dia. DP	(Outer Dia.) (DO)	Bore Dia. d		Hub Dia.		Approx. Mass (kg)
					Pilot bore	Max.	Pilot bore DH	Max. L	
RS35-1B13T-P	13	5.30	39.80	44	9.5	14	32	20	0.02
RS35-1B14T-P	14	5.69	42.80	46	9.5	15	30	20	0.02
RS35-1B15T-P	15	6.08	45.81	51	9.5	17	35	20	0.02
RS35-1B16T-P	16	6.47	48.82	53	9.5	19	37	20	0.03
RS35-1B17T-P	17	6.86	51.84	57	9.5	22	41	20	0.03
RS35-1B18T-P	18	7.26	54.85	60	12.7	22	44	20	0.04
RS35-1B20T-P	20	8.04	60.89	66	12.7	27	50	20	0.05
RS35-1B22T-P	22	8.83	66.93	72	12.7	28	53	20	0.06
RS35-1B24T-P	24	9.71	72.97	78	12.7	32	60	22	0.08
RS35-1B25T-P	25	10.1	76.00	81	12.7	32	60	22	0.08
RS35-1B26T-P	26	10.5	79.02	83	12.7	35	65	22	0.09
RS35-1B28T-P	28	11.3	85.07	90	12.7	40	70	22	0.10
RS35-1B30T-P	30	12.1	91.12	96	12.7	42	75	22	0.12

RS40

Hub with groove (12T)

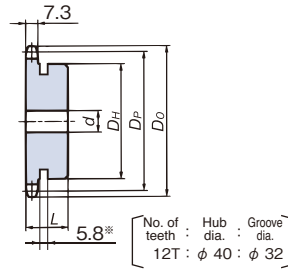

Hub without groove (13T and over)

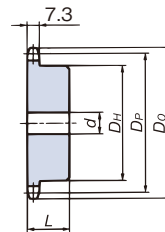

Model No.	No. of Teeth	Allowable Transmission Torque N · m	Pitch Circle Dia. DP	(Outer Dia.) (DO)	Bore Dia. d		Hub Dia.		Approx. Mass (kg)
					Pilot bore	Max.	Pilot bore DH	Max. L	
RS40-1B12T-P	12	10.8	49.07	53	9.5	16	40	22	0.03
RS40-1B13T-P	13	11.7	53.07	58	12.7	18	37	22	0.04
RS40-1B14T-P	14	12.6	57.07	63	12.7	22	42	22	0.04
RS40-1B15T-P	15	13.4	61.08	67	12.7	25	46	22	0.05
RS40-1B16T-P	16	14.3	65.10	71	12.7	27	50	22	0.06
RS40-1B17T-P	17	15.3	69.12	75	12.7	28	54	22	0.07
RS40-1B18T-P	18	16.2	73.14	78	12.7	30	57	22	0.08
RS40-1B20T-P	20	17.9	81.18	88	12.7	35	67	25	0.11
RS40-1B22T-P	22	19.6	89.24	96	12.7	42	75	25	0.14
RS40-1B24T-P	24	21.5	97.30	104	12.7	50	80	25	0.16
RS40-1B25T-P	25	22.4	101.33	108	12.7	50	80	25	0.17
RS40-1B26T-P	26	23.2	105.36	112	12.7	52	85	25	0.18
RS40-1B28T-P	28	25.0	113.43	120	12.7	55	90	25	0.21
RS40-1B30T-P	30	26.8	121.50	128	12.7	60	100	25	0.26

RS50

Hub with groove (13T)

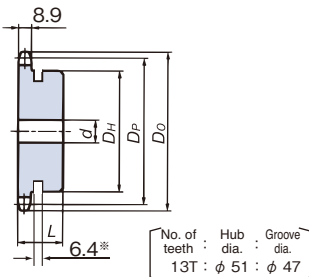

Hub without groove (14T and over)

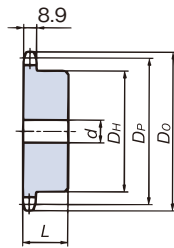

Model No.	No. of Teeth	Allowable Transmission Torque N · m	Pitch Circle Dia. DP	(Outer Dia.) (DO)	Bore Dia. d		Hub Dia.		Approx. Mass (kg)
					Pilot bore	Max.	Pilot bore DH	Max. L	
RS50-1B13T-P	13	22.8	66.34	73	12.7	25	51	25	0.07
RS50-1B14T-P	14	24.5	71.34	78	12.7	28	52	25	0.08
RS50-1B15T-P	15	26.2	76.35	83	12.7	30	57	25	0.09
RS50-1B16T-P	16	27.9	81.37	89	12.7	32	62	25	0.11
RS50-1B17T-P	17	29.6	86.39	93	12.7	35	67	25	0.12
RS50-1B18T-P	18	31.4	91.42	98	12.7	40	72	28	0.15
RS50-1B20T-P	20	34.8	101.48	110	15.9	50	80	28	0.20
RS50-1B22T-P	22	38.2	111.55	120	15.9	55	90	28	0.24
RS50-1B24T-P	24	41.8	121.62	130	15.9	60	100	28	0.29
RS50-1B25T-P	25	43.4	126.66	135	15.9	60	100	28	0.31
RS50-1B26T-P	26	45.2	131.70	140	18	65	110	28	0.34
RS50-1B28T-P	28	48.6	141.79	150	18	70	120	28	0.40
RS50-1B30T-P	30	52.2	151.87	161	18	70	120	28	0.43

RS60

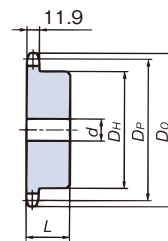

Model No.	No. of Teeth	Allowable Transmission Torque N · m	Pitch Circle Dia. DP	(Outer Dia.) (DO)	Bore Dia. d		Hub Dia.		Approx. Mass (kg)
					Pilot bore	Max.	Pilot bore DH	Max. L	
RS60-1B13T-P	13	41.0	79.60	88	15.9	30	57	32	0.12
RS60-1B14T-P	14	44.1	85.61	93	15.9	32	62	32	0.14
RS60-1B15T-P	15	47.2	91.62	99	15.9	35	68	32	0.16
RS60-1B16T-P	16	50.3	97.65	107	15.9	42	73	32	0.19
RS60-1B17T-P	17	53.3	103.67	113	15.9	50	80	32	0.21
RS60-1B18T-P	18	56.5	109.71	119	15.9	52	85	40	0.30
RS60-1B20T-P	20	62.7	121.78	132	15.9	60	95	40	0.38
RS60-1B22T-P	22	68.9	133.86	144	15.9	65	110	40	0.51
RS60-1B24T-P	24	75.1	145.95	156	18	70	120	40	0.57
RS60-1B25T-P	25	78.3	151.99	162	18	70	120	40	0.59
RS60-1B26T-P	26	81.4	158.04	168	18	70	120	40	0.62
RS60-1B28T-P	28	87.6	170.14	180	18	70	120	40	0.65
RS60-1B30T-P	30	93.8	182.25	193	18	70	120	40	0.70

Note: The dimensions shown in this catalog are nominal dimensions and differ from actual dimensions.

RS Fit Bore Sprockets

Fit Bore Sprockets have finished bores. Tsubaki offers two types: sprockets with finished bores and easy bore finishing types.

- 1 Finished bores : **Stocked** 2 Easy bore finishing : **Made-to-order**

Features of Tsubaki Fit Bore Sprockets

Smooth, Smart, Speedy

There are codes for finishing types, making ordering by model number and delivery quick and easy.

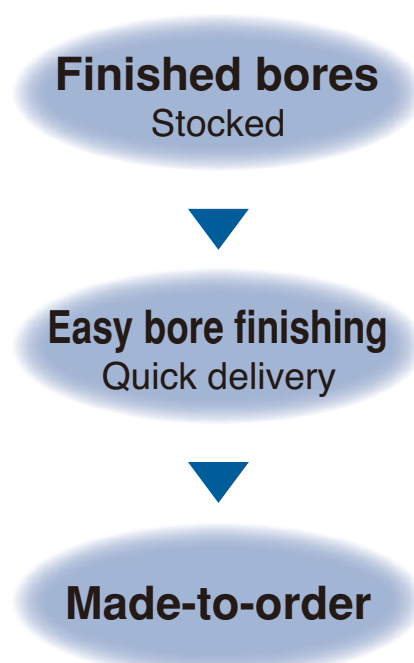
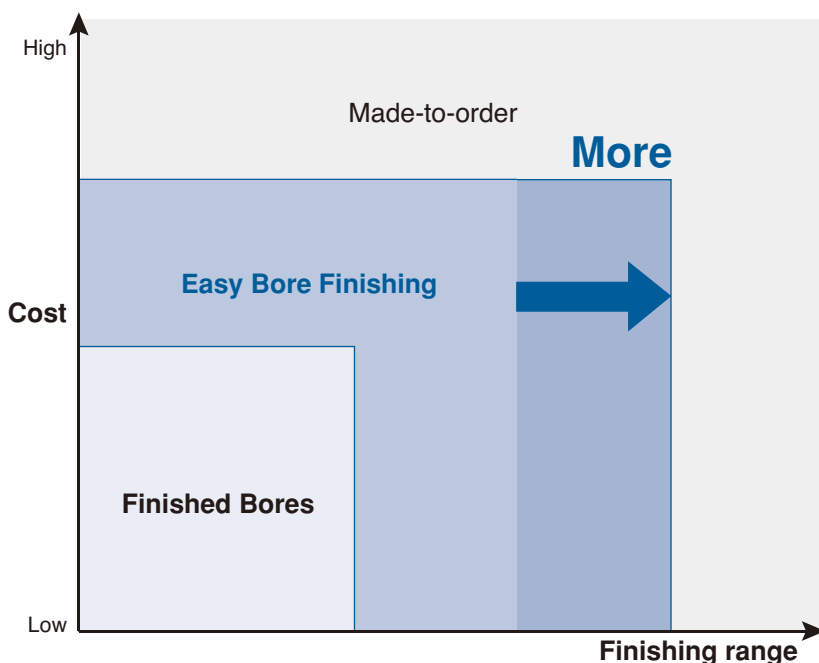

Availability

Finished Bore Types (Stocked)

RS Sprockets	1B type	RS35 – RS100
		Teeth are hardened

Easy Bore Finishing Types (Made-to-order) *Standard versions of the following pilot bore sprockets are stocked items.

RS Sprockets	● Single types	RS35 – RS160	● Double types	RS40 – RS120
	● SD types	RS40 – RS80	● Stainless steel single types	RS35 – RS80

Fit Bore Sprockets

Specifications

- Tooth hardening** All models have hardened teeth.
- Bore** Features bore diameters often required by motors, reducers, etc. Finished to H7 tolerance.
- Key way** Finished to tooth valley standards based on (JIS B1301-1976 new JIS standards) normal type parallel key (Js9).
- Set screws** All models come with set screws in two locations (above the keyway and at 90°, or at 120° if bore hole is finished to over $\phi 40$ mm).

Model Numbering Example

RS40-1B 20T Q - H 15 J

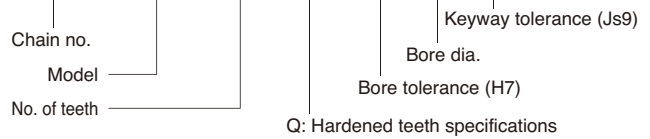

Stocked item

Bore tolerance (mm)

Bore diameter	Tolerance (H7)	Available bore dia. ϕd mm	Key KW	Tolerance (Js9)	Key KH	Tolerance	Set screw MX
6 and up to 10	+0.015 0	10 and up to 12	4	±0.0150	1.8	+0.1 0	M4
10 and up to 18	+0.018 0	12 and up to 17	5		2.3		M5
18 and up to 30	+0.021 0	17 and up to 22	6		2.8		M6
30 and up to 50	+0.025 0	22 and up to 30	8	±0.0180	3.3	+0.2 0	M8
		30 and up to 38	10		3.8		
		38 and up to 44	12		4.3		
		44 and up to 50	14	±0.0215	4.3	0	M10
		50 and up to 58	16		4.4		
		58 and up to 65	18				

Set screw specifications

- Steel cup point set screws with hexagonal holes.

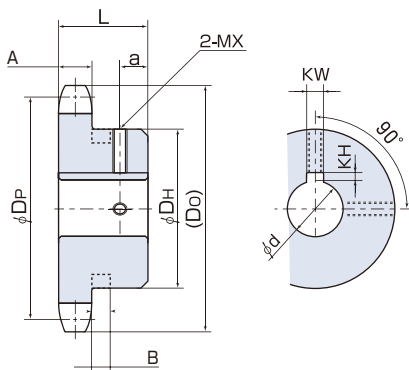

List of RS35 sprockets

A dimension: 4.4 B dimension: 4.8

Model Number	Outer Dia. (Do)	Pitch Circle Dia. (Dp)	Hub Dia. (Dh)	Hub Length L	Tap Position a	No. of Teeth	RS35 finished bore dia. ϕd mm Tolerance (H7)
RS35-1B 9TQ-H□□□	32	27.85	22	20	5	9*	10
RS35-1B 10TQ-H□□□	35	30.82	25	20	5	10*	10 12
RS35-1B 11TQ-H□□□	38	33.81	27	20	5	11*	10 12 14
RS35-1B 12TQ-H□□□	41	36.80	31	20	5	12*	10 12 14 15 16
RS35-1B 13TQ-H□□□	44	39.80	32	20	5	13*	10 12 14 15 16 17 18
RS35-1B 14TQ-H□□□	47	42.81	30	20	8	14	10 12 14 15 16
RS35-1B 15TQ-H□□□	51	45.81	35	20	8	15	10 12 14 15 16 17 18 19
RS35-1B 16TQ-H□□□	54	48.82	37	20	8	16	10 12 14 15 16 17 18 19 20
RS35-1B 17TQ-H□□□	57	51.84	41	20	8	17	12 14 15 16 17 18 19 20 22 24
RS35-1B 18TQ-H□□□	60	54.85	44	20	8	18	12 14 15 16 17 18 19 20 22 24
RS35-1B 19TQ-H□□□	63	57.87	47	20	8	19	12 14 15 16 17 18 19 20 22 24 25 28
RS35-1B 20TQ-H□□□	66	60.89	50	20	8	20	12 14 15 16 17 18 19 20 22 24 25 28 30
RS35-1B 21TQ-H□□□	69	63.91	53	20	8	21	12 14 15 16 17 18 19 20 22 24 25 28 30 32
RS35-1B 22TQ-H□□□	72	66.93	53	20	8	22	12 14 15 16 17 18 19 20 22 24 25 28 30 32
RS35-1B 23TQ-H□□□	75	69.95	53	20	8	23	12 14 15 16 17 18 19 20 22 24 25 28 30 32
RS35-1B 24TQ-H□□□	78	72.97	53	22	10/7°	24	12 14 15 16 17 18 19 20 22 24* 25* 28* 30* 32*
RS35-1B 25TQ-H□□□	81	76.00	53	22	10/7°	25	15 16 17 18 19 20 22 24* 25* 28* 30* 32*
RS35-1B 26TQ-H□□□	84	79.02	53	22	10/7°	26	15 16 17 18 19 20 22 24* 25* 28* 30* 32*
RS35-1B 27TQ-H□□□	87	82.05	53	22	10/7°	27	15 16 17 18 19 20 22 24* 25* 28* 30* 32*
RS35-1B 28TQ-H□□□	90	85.07	53	22	10/7°	28	15 16 17 18 19 20 22 24* 25* 28* 30* 32*
RS35-1B 30TQ-H□□□	96	91.12	53	22	10/7°	30	15 16 17 18 19 20 22 24* 25* 28* 30* 32*
RS35-1B 32TQ-H□□□	102	97.18	53	22	10/7°	32	15 16 17 18 19 20 22 24* 25* 28* 30* 32*
RS35-1B 34TQ-H□□□	109	103.23	53	22	10/7°	34	15 16 17 18 19 20 22 24* 25* 28* 30* 32*
RS35-1B 35TQ-H□□□	112	106.26	53	22	10/7°	35	15 16 17 18 19 20 22 24* 25* 28* 30* 32*
RS35-1B 36TQ-H□□□	115	109.29	53	22	10/7°	36	15 16 17 18 19 20 22 24* 25* 28* 30* 32*
RS35-1B 38TQ-H□□□	121	115.34	63	25	10	38	20 22 24 25 28 30 32 35 38
RS35-1B 40TQ-H□□□	127	121.40	63	25	10	40	20 22 24 25 28 30 32 35 38

Note: 1. Items with an * are provided with a groove on the hub perimeter to prevent sprocket – chain interference. See pg. 26 for groove diameters.
 2. Bore diameters with an * have a tap position at 7mm.
 3. The dimensions shown in this catalog are nominal dimensions and differ from actual dimensions.

Fit Bore Sprockets

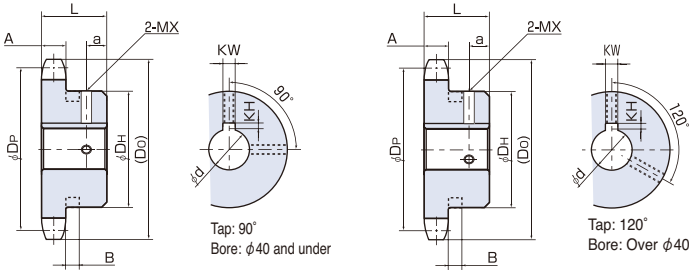

Available bore dia. ϕ d mm	Key KW	Tolerance (Js9)	Key KH	Tolerance	Set screw MX
10 and up to 12	4	± 0.0150	1.8	$+0.1$ 0	M4
12 and up to 17	5		2.3		M5
17 and up to 22	6		2.8		M6
22 and up to 30	8	± 0.0180	3.3	$+0.2$ 0	M8
30 and up to 38	10				
38 and up to 44	12	± 0.0215	3.8		
44 and up to 50	14		4.3		
50 and up to 58	16		4.4		
58 and up to 65	18			M10	

Stocked item

List of RS40 sprockets

A dimension: 7.3 B dimension: 5.8

Model Number	(Outer Dia.) D_o	Pitch Circle Dia. D_p	Hub Dia. D_H	Hub Length L	Tap Position a	No. of Teeth	RS40 finished bore dia. ϕ d mm Tolerance (H7)
RS40-1B 9TQ-H□□□	43	37.13	28	22	5	9*	10 12 14 15
RS40-1B 10TQ-H□□□	46	41.10	32	22	5	10*	10 12 14 15 16
RS40-1B 11TQ-H□□□	51	45.08	37	22	5	11*	10 12 14 15 16 17 18 19 20
RS40-1B 12TQ-H□□□	55	49.07	40	22	5	12*	10 12 14 15 16 17 18 19 20 22
RS40-1B 13TQ-H□□□	59	53.07	37	22	7	13	12 14 15 16 17 18 19 20
RS40-1B 14TQ-H□□□	63	57.07	42	22	7	14	12 14 15 16 17 18 19 20 22 24
RS40-1B 15TQ-H□□□	67	61.08	46	22	7	15	12 14 15 16 17 18 19 20 22 24 25 28
RS40-1B 16TQ-H□□□	71	65.10	50	22	7	16	14 15 16 17 18 19 20 22 24 25 28 30
RS40-1B 17TQ-H□□□	76	69.12	54	22	7	17	14 15 16 17 18 19 20 22 24 25 28 30 32
RS40-1B 18TQ-H□□□	80	73.14	57	22	7	18	14 15 16 17 18 19 20 22 24 25 28 30 32 35
RS40-1B 19TQ-H□□□	84	77.16	62	22	7	19	14 15 16 17 18 19 20 22 24 25 28 30 32 35 38
RS40-1B 20TQ-H□□□	88	81.18	67	25	7	20	14 15 16 17 18 19 20 22 24 25 28 30 32 35 38 40 42 45
RS40-1B 21TQ-H□□□	92	85.21	71	25	7	21	14 15 16 17 18 19 20 22 24 25 28 30 32 35 38 40 42 45
RS40-1B 22TQ-H□□□	96	89.24	75	25	7	22	14 15 16 17 18 19 20 22 24 25 28 30 32 35 38 40 42 45 48
RS40-1B 23TQ-H□□□	100	93.27	77	25	7	23	14 15 16 17 18 19 20 22 24 25 28 30 32 35 38 40 42 45 48
RS40-1B 24TQ-H□□□	104	97.30	63	25	7	24	14 15 16 17 18 19 20 22 24 25 28 30 32 35 38 40 42
RS40-1B 25TQ-H□□□	108	101.33	63	25	7	25	14 15 16 17 18 19 20 22 24 25 28 30 32 35 38 40 42
RS40-1B 26TQ-H□□□	112	105.36	63	25	7	26	14 15 16 17 18 19 20 22 24 25 28 30 32 35 38 40 42
RS40-1B 27TQ-H□□□	116	109.40	63	25	7	27	14 15 16 17 18 19 20 22 24 25 28 30 32 35 38 40 42
RS40-1B 28TQ-H□□□	120	113.43	63	25	7	28	14 15 16 17 18 19 20 22 24 25 28 30 32 35 38 40 42
RS40-1B 30TQ-H□□□	128	121.50	63	25	7	30	14 15 16 17 18 19 20 22 24 25 28 30 32 35 38 40 42
RS40-1B 32TQ-H□□□	137	129.57	68	28	8	32	20 22 24 25 28 30 32 35 40
RS40-1B 34TQ-H□□□	145	137.64	68	28	8	34	20 22 24 25 28 30 32 35 40
RS40-1B 35TQ-H□□□	149	141.68	68	28	8	35	20 22 24 25 28 30 32 35 40
RS40-1B 36TQ-H□□□	153	145.72	68	28	8	36	20 22 24 25 28 30 32 35 40
RS40-1B 38TQ-H□□□	161	153.79	68	28	8	38	24 25 28 30 32 35 40
RS40-1B 40TQ-H□□□	169	161.87	68	28	8	40	25 28 30 32 35 40

Note: 1. Items with an * are provided with a groove on the hub perimeter to prevent sprocket – chain interference. See pg. 28 for groove diameters.
2. The dimensions shown in this catalog are nominal dimensions and differ from actual dimensions.

List of RS50 sprockets

A dimension: 8.9 B dimension: 6.4

Model Number	(Outer Dia.) D_o	Pitch Circle Dia. D_p	Hub Dia. D_H	Hub Length L	Tap Position a	No. of Teeth	RS50 finished bore dia. ϕ d mm Tolerance (H7)
RS50-1B 9TQ-H□□□	53	46.42	34	25	6	9*	16 17 18 19
RS50-1B 10TQ-H□□□	58	51.37	40	25	6	10*	15 16 17 18 19 20 22
RS50-1B 11TQ-H□□□	64	56.35	46	25	6	11*	15 16 17 18 19 20 22 24 25
RS50-1B 12TQ-H□□□	69	61.34	51	25	6	12*	15 16 17 18 19 20 22 24 25 28 30 32
RS50-1B 13TQ-H□□□	74	66.33	51	25	6	13*	14 15 16 17 18 19 20 22 24 25 28 30 32
RS50-1B 14TQ-H□□□	79	71.34	52	25	7	14	14 15 16 17 18 19 20 22 24 25 28 30 32
RS50-1B 15TQ-H□□□	84	76.35	57	25	7	15	14 15 16 17 18 19 20 22 24 25 28 30 32 35
RS50-1B 16TQ-H□□□	89	81.37	62	25	7	16	14 15 16 17 18 19 20 22 24 25 28 30 32 35 38 40
RS50-1B 17TQ-H□□□	94	86.39	67	25	7	17	14 15 16 17 18 19 20 22 24 25 28 30 32 35 38 40 42 45
RS50-1B 18TQ-H□□□	100	91.42	72	28	8	18	14 15 16 17 18 19 20 22 24 25 28 30 32 35 38 40 42 45
RS50-1B 19TQ-H□□□	105	96.45	73	28	8	19	14 15 16 17 18 19 20 22 24 25 28 30 32 35 38 40 42 45
RS50-1B 20TQ-H□□□	110	101.48	73	28	8	20	14 15 16 17 18 19 20 22 24 25 28 30 32 35 38 40 42 45
RS50-1B 21TQ-H□□□	115	106.51	73	28	8	21	17 18 19 20 22 24 25 28 30 32 35 38 40 42 45
RS50-1B 22TQ-H□□□	120	111.55	73	28	8	22	17 18 19 20 22 24 25 28 30 32 35 38 40 42 45
RS50-1B 23TQ-H□□□	125	116.59	73	28	8	23	17 18 19 20 22 24 25 28 30 32 35 38 40 42 45
RS50-1B 24TQ-H□□□	130	121.62	73	28	8	24	17 18 19 20 22 24 25 28 30 32 35 38 40 42 45
RS50-1B 25TQ-H□□□	135	126.66	73	28	8	25	17 18 19 20 22 24 25 28 30 32 35 38 40 42 45
RS50-1B 26TQ-H□□□	140	131.70	73	28	8	26	25 28 30 32 35 38 40 45
RS50-1B 27TQ-H□□□	145	136.74	73	28	8	27	25 28 30 32 35 38 40 45
RS50-1B 28TQ-H□□□	150	141.79	73	28	8	28	25 28 30 32 35 38 40 42 45
RS50-1B 30TQ-H□□□	161	151.87	73	28	8	30	25 28 30 32 35 38 40 45
RS50-1B 32TQ-H□□□	171	161.96	73	28	8	32	25 28 30 32 35 38 40 45
RS50-1B 34TQ-H□□□	181	172.05	73	28	8	34	25 28 30 32 35 38 40 45
RS50-1B 35TQ-H□□□	186	177.10	73	28	8	35	25 28 30 32 35 38 40 45

Note: 1. Items with an * are provided with a groove on the hub perimeter to prevent sprocket – chain interference. See pg. 30 for groove diameters.
2. The dimensions shown in this catalog are nominal dimensions and differ from actual dimensions.

Before Use
Standard Roller Chains
Heavy Duty Roller Chains
Corrosion Resistant Roller Chains
Specialty Roller Chains
Sprockets
Pin Gear Drives
Accessories
Selection
Handling

Fit Bore Easy Bore Finishing Service

Quick delivery of sprockets with finished bores thanks to accurate quality control. Tsubaki offers a wide-range of stocked bore finishing specifications.

1. Features

Select the hub model, number of teeth, tooth hardening, surface treatment, bore diameter, bore tolerance, keyway tolerance, and tap hole processing for available models.

2. Available models

Models available for easy bore finishing	
RS Sprockets (1A, 1B, 2B, and 1C and SD models)	Available models are the stocked pilot bore types on the left.
Stainless Steel Type	

List of Sprockets Available for Easy Bore Finishing

RS Sprockets

Models in shaded areas have hardened teeth.

Model No. of Teeth	Steel																								Stainless Steel													
	Single strand												Double strand						SD Type				Single strand															
	35	40			50			60			80			100			120			140			160			40	50	60	80	35	40	50	60	80				
B	1A	1B	1C	1A	1B	1C	1A	1B	1C	1A	1B	1C	1A	1B	1C	1A	1B	1B	1B	2B	2B	2B	2B	2B	2B	40	50	60	80	1B	1B	1B	1B	1B				
9	○		○																																			
10	○		○																																			
11	○		○																																			
12	○	○	○																																			
13	○	○	○																																			
14	○	○	○																																			
15	○	○	○																																			
16	○	○	○																																			
17	○	○	○																																			
18	○	○	○																																			
19	○	○	○																																			
20	○	○	○																																			
21	○	○	○																																			
22	○	○	○																																			
23	○	○	○																																			
24	○	○	○																																			
25	○	○	○																																			
26	○	○	○																																			
27	○	○	○																																			
28	○	○	○																																			
30	○	○	○																																			
32	○	○	○																																			
34	○	○	○																																			
35	○	○	○																																			
36	○	○	○																																			
38	○	○	○																																			
40	○	○	○																																			
42	○	○	○																																			
45	○	○	○																																			
48	○	○	○																																			
50	○	○	○																																			
54	○	○	○																																			
60	○	○	○																																			
65	○	○	○																																			
70	○	○	○																																			
75	○	○	○																																			

Note: Contact a Tsubaki representative regarding surface treatment.

Fit Bore Easy Bore Finishing Service

RS Sprocket (standard sprockets with hardened teeth)

Shaded areas indicate standard types with hardened teeth

Model No. of Teeth	Steel																																		
	Single strand															Double strand																			
	35			40			50			60			80			100			120		140		160		40		50		60		80		100		120
	B	1A	1B	1C	1A	1B	1C	1A	1B	1C	1A	1B	1C	1A	1B	1C	1A	1B	1B	1B	2B	2B	2B	2B	2B	2B	2B	2B	2B	2B	2B				
9																																			
10																																			
11																																			
12																																			
13																																			
14																																			
15																																			
16																																			
17																																			
18																																			
19																																			
20																																			
21																																			
22																																			
23																																			
24																																			
25																																			
26																																			
27																																			
28																																			
30																																			
32																																			
34																																			
35																																			
36																																			
38																																			
40																																			
42																																			
45																																			
48																																			
50																																			
54																																			
60																																			
65																																			
70																																			
75																																			

Note: Contact a Tsubaki representative regarding surface treatment.

List of Sprockets Available for Surface Treatment

RS Sprockets

Model No. of Teeth	Steel																
	Single strand									Double strand			SD Type				
	35			40			50			60			40	50	60	80	
	B	1A	1B	1C	1A	1B	1C	1A	1B	1C	2B	2B	2B				
9	○																
10	○																
11	○																
12	○	○									○	○	○		○	○	○
13	○	○									○	○	○		○	○	○
14	○	○									○	○	○		○	○	○
15	○	○									○	○	○		○	○	○
16	○	○									○	○	○		○	○	○
17	○	○									○	○	○		○	○	○
18	○	○									○	○	○		○	○	○
19	○	○									○	○	○		○	○	○
20	○	○									○	○	○		○	○	○
21	○	○									○	○	○		○	○	○
22	○	○									○	○	○		○	○	○
23	○	○									○	○	○		○	○	○
24	○	○									○	○	○		○	○	○
25	○	○									○	○	○		○	○	○
26	○	○									○	○	○		○	○	○

Model No. of Teeth	Steel																
	Single strand									Double strand			SD Type				
	35			40			50			60			40	50	60	80	
	B	1A	1B	1C	1A	1B	1C	1A	1B	1C	2B	2B	2B				
27	○	○									○	○	○		○	○	○
28	○	○									○	○	○		○	○	○
30	○	○									○	○	○		○	○	○
32	○	○									○	○	○		○	○	○
34	○	○									○	○	○		○	○	○
35	○	○									○	○	○		○	○	○
36	○	○									○	○	○		○	○	○
38	○	○									○	○	○		○	○	○
40	○	○									○	○	○		○	○	○
42	○	○									○	○	○		○	○	○
45	○	○									○	○	○		○	○	○
48	○	○									○	○	○		○	○	○
50	○	○									○	○	○		○	○	○
54	○	○									○	○	○		○	○	○
60	○	○									○	○	○		○	○	○
65	○	○									○	○	○		○	○	○
70	○	○									○	○	○		○	○	○
75	○										○	○	○		○	○	○

Surface Treatment Types and Delivery

Code when Ordering	Specifications	Delivery
B	Black oxide treatment	Contact a Tsubaki representative regarding delivery.
K	Electroless nickel-phosphorous plating	
C	Electrogalvanized trivalent chromate	

Note: Black oxide treatment may require additional finishing (bore, keyway, tap hole). The other two specifications will not require additional finishing.

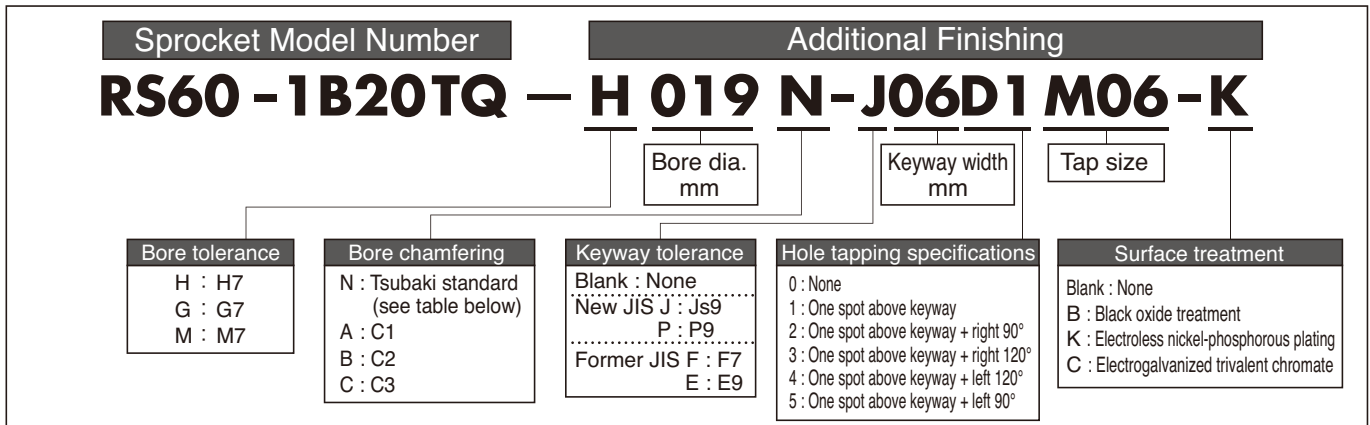

Fit Bore Easy Bore Finishing Service

3. Model Numbering Example

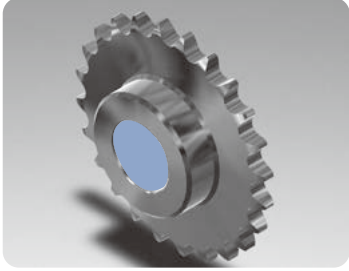

4. Specifications

Bore Finishing Range

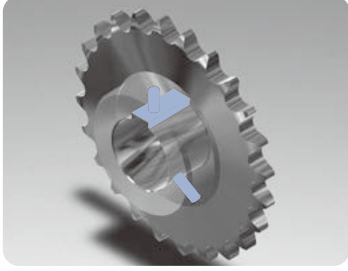
Bore Finishing	Keyway Finishing	Hole Tapping
		
<ul style="list-style-type: none"> Whole number dimensions only in 1 mm units. No imperial (inch) dimensions available. Tolerance: Selectable 	<ul style="list-style-type: none"> Parallel keyways only. Tolerance: Selectable Keyway width and height follow JIS standards 	<ul style="list-style-type: none"> Tap size: Selectable Choose up to two (2) hole locations (See pg. 9 for positions.) Set screws provided.

List of Finishing Dimensions (mm)

With a key tolerance of Js9, P9 (new JIS)

Bore Dia.	Keyway Width	Tap Size	Bore Mounting Dim.
10~12	1.0	4	M4
12~17		5	M4, M5
17~20		6	M5, M6
20~22	1.2	8	M5, M6, M8
22~30		10	M6, M8, M10
30~32		12	
32~38	1.6	14	M8, M10, M12
38~44		16	
44~50		18	
50~58	2.5	20	M10, M12, M16
58~65		22	
65~75		25	
75~80	3.0	28	M12, M16, M20
80~85		32	
85~95			
95~110			
110~130			

With a key tolerance of F7, E9 (former JIS)

Bore Dia.	Keyway Width	Tap Size	Bore Mounting Dim.
10~13	1.0	4	M4
14~20		5	M4, M5
21~30	1.2	7	M5, M6
31~32		10	M6, M8, M10
33~40	12		
41~50	1.6	15	
51~60		18	M8, M10, M12
61~70		20	
71~80	2.5	24	M10, M12, M16
81~95		28	
96~110		32	
111~125	3.0	35	M12, M16, M20
126~140			

Note: The bore chamfering dimension will be 1/2 the above (new JIS) when there is no keyway.

Tsubaki standard bore chamfering

Bore dia.	Bore chamfering
10~20	1
21~32	1.2
33~50	1.6
51~80	2.5
81~130	3

Available bore chamfering

Bore dia.	Amount of chamfering that can be selected			
10~17	N	A	—	—
18~44	N	A	B	—
45~130	N	A	B	C

*Choose from keyway height (an amount of chamfering that does not exceed keyway height)

*Use half of the values shown in the table above when there is no keyway.

*Areas where the Tsubaki standard bore chamfering and designated chamfering overlap, the designated chamfering shall be used.

Fit Bore Easy Bore Finishing Service

Bore Finishing and Tap Hole Position Types and Details

Processing Code			A type	B type	C type	SD type	2B type	
Bore	Key	Tap						
—	—	0						
		0	—					
	—	—	1	—				
			2	—				
			3	—				
			4	—				
			5	—				
	—	—	1	—				
			2	—				
			3	—				
4			—					
5			—					

Note: Contact a Tsubaki representative regarding bore and keyway dimensional tolerances and tap hole positioning.

Lock Sprocket (keyless friction type integrated coupling sprocket) S Type

Lock Sprockets are sprockets with integrated keyless friction type integrated couplings. Available models: RS35 to RS100 1B Type sprockets

■ Features

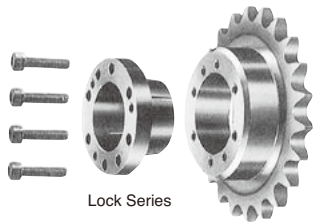

1. No wobbling after mounting (tightening)
2. Easy phase alignment
3. Easy mounting and dismounting
4. No retainers required

■ Tightening Principle

The inner diameter of the sprocket and the outer diameter of the lock sleeve are tapered. When the mounting bolts are tightened, the sprocket will slide and move up on the tapered surface. A wedge action will generate force P and force P' in the radial direction to press on the shaft and tapered inner side, and frictional force will tightly secure the sprocket and shaft.

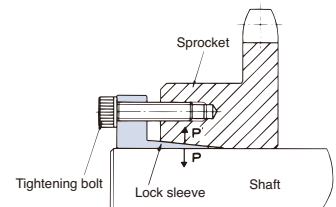

■ Bolt Tightening Positions

The same sleeve is used for all models, so some holes may not be used. Check the installation guide that comes with the product before attaching the mounting bolts for use.

■ Direction of Sprocket Movement when Tightening Bolts

When mounting a Lock Series S Type sprocket, the sprocket will move 0.5mm – 1.0mm in the direction of the shaft between the time the sprocket is initially secured and the time the sprocket is tightened. Therefore, take this movement into consideration when centering the sprocket. The amount of sprocket movement varies with the type. (See the illustration on the right.)

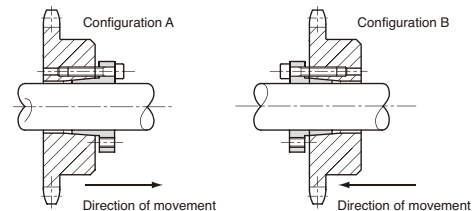

■ General Precautions

- 1) Allowable transmission torque
Ensure that the load torque does not exceed the specified transmission torque in the dimension table.
- 2) Shaft diameter tolerance and surface roughness
Use a shaft diameter tolerance of h8 and a surface roughness degree of 12S as your standards.
- 3) Mounting to shafts provided with keyways or D-shaped shafts
The allowable transmission torque will decrease by 10% when mounting the sprocket to a shaft provided with a finished keyway, such as a motor shaft, or to a D-shaped shaft.
- 4) Mounting to cold finished carbon steel bars
The allowable transmission torque will decrease by 10% when mounting the sprocket to a cold finished carbon steel bar (drawn steel with an allowable diameter of 8 – 10 class).
- 5) Ensure that the shaft is a solid shaft using S35C grade or higher steel.
- 6) Operating temperature range: -20°C to 200°C
- 7) Always use a torque wrench when tightening the bolts. (Refer to the torque wrench operation manual for proper use.)

Ordering Lock Series S Type Sprockets

Please include the product code and model number in your order.

■ Sleeve Mounting Configuration

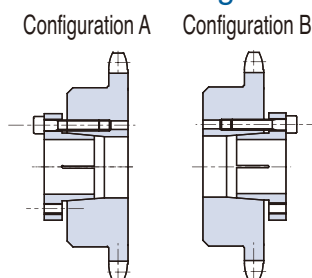

*Caution regarding sleeve mounting:
RS35-1B19T-S33□□□
RS40-1B15T-S33□□□
The above models can use configuration A only, as configuration B will cause interference with the chain.

■ Model Numbering Example

RS40-1B21TQ-S4825A

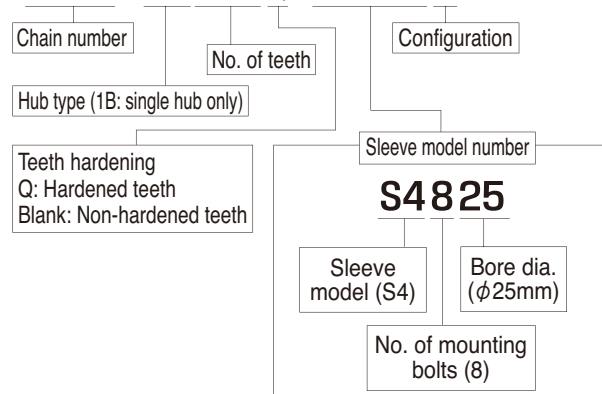

RS35 Lock Series (S Type)

RS35

● Applicable chain pitch : 9.525mm ● Roller dia : 5.08mm

Configuration A

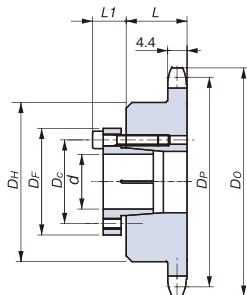

Configuration B

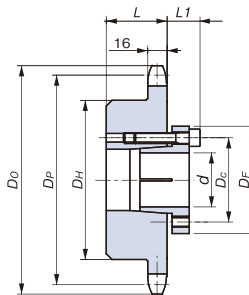

Lock Series S Type dimensions

Sleeve Model	ϕD_F (mm)	ϕD_C (mm)	L_1 (mm)	Bolt Size (M x S)	Tightening Torque (N·m)
S1	32.0	24.0	12.0	M4 × 16	4.2
S2	42.0	32.0	14.0	M5 × 18	8.3
S3	48.0	38.5	15.5	M5 × 20	8.3
S4	56.0	46.0	15.5	M5 × 20	8.3
S5	66.0	56.0	17.5	M5 × 22	8.3
S6	80.0	68.0	21.0	M6 × 25	16.8
S7	101.0	86.0	24.5	M8 × 30	40.5

Model Numbering Example

RS35-1B23TQ-S1616

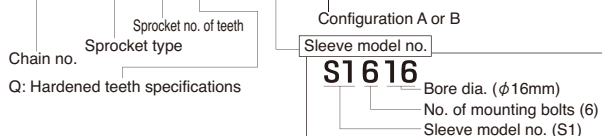

Dimensions

All models feature hardened teeth.

Model Number	Pitch Circle Dia. D_P	(Outer Dia.) (D_O)	Hub Dia. D_H	Hub Length L	Applicable Bore Dia. d										No. of Teeth		
					10	11	12	14	15	16	17	18	19	20		22	
RS35-1B15TQ-S14	45.81	51	35	20	●	●	●	●	●	●							15
RS35-1B16TQ-S14	48.82	54	37	20	●	●	●	●	●	●							16
RS35-1B17TQ-S14	51.84	57	41	20	●	●	●	●	●	●							17
RS35-1B17TQ-S24	51.84	57	41	20							●	●	●	●	●		17
RS35-1B18TQ-S14	54.85	60	44	20		●	●	●	●	●							18
RS35-1B18TQ-S24	54.85	60	44	20							●	●	●	●	●		18
RS35-1B19TQ-S14	57.87	63	47	20		●	●	●	●	●							19
RS35-1B19TQ-S24	57.87	63	47	20							●	●	●	●	●		19
RS35-1B20TQ-S14	60.89	66	50	20			●	●	●	●							20
RS35-1B20TQ-S24	60.89	66	50	20							●	●	●	●	●		20
RS35-1B21TQ-S16	63.91	69	53	20				●	●	●							21
RS35-1B21TQ-S24	63.91	69	53	20							●	●	●	●	●		21
RS35-1B22TQ-S16	66.93	72	53	20				●	●	●							22
RS35-1B22TQ-S24	66.93	72	53	20							●	●	●	●	●		22
RS35-1B23TQ-S16	69.95	75	53	20				●	●	●							23
RS35-1B23TQ-S24	69.95	75	53	20							●	●	●	●	●		23
RS35-1B24TQ-S16	72.97	78	53	20				●	●	●							24
RS35-1B24TQ-S24	72.97	78	53	20							●	●	●	●	●		24
RS35-1B25TQ-S16	76.00	81	53	20				●	●	●							25
RS35-1B25TQ-S24	76.00	81	53	20							●	●	●	●	●		25
RS35-1B26TQ-S16	79.02	84	53	22				●	●	●							26
RS35-1B26TQ-S24	79.02	84	53	22							●	●	●	●	●		26
RS35-1B27TQ-S16	82.05	87	53	22				●	●	●							27
RS35-1B27TQ-S24	82.05	87	53	22							●	●	●	●	●		27
RS35-1B28TQ-S16	85.07	90	53	22				●	●	●							28
RS35-1B28TQ-S24	85.07	90	53	22							●	●	●	●	●		28
RS35-1B30TQ-S16	91.12	96	53	22				●	●	●							30
RS35-1B30TQ-S24	91.12	96	53	22							●	●	●	●	●		30
RS35-1B32TQ-S16	97.18	102	53	22				●	●	●							32
RS35-1B32TQ-S24	97.18	102	53	22							●	●	●	●	●		32
RS35-1B34TQ-S16	103.23	109	53	22				●	●	●							34
RS35-1B34TQ-S24	103.23	109	53	22							●	●	●	●	●		34
RS35-1B35TQ-S16	106.26	112	53	22				●	●	●							35
RS35-1B35TQ-S24	106.26	112	53	22							●	●	●	●	●		35
RS35-1B36TQ-S16	109.29	115	53	22				●	●	●							36
RS35-1B36TQ-S24	109.29	115	53	22							●	●	●	●	●		36
RS35-1B38TQ-S16	115.34	121	63	25				●	●	●							38
RS35-1B38TQ-S24	115.34	121	63	25							●	●	●	●	●		38
RS35-1B40TQ-S16	121.40	127	63	25				●	●	●							40
RS35-1B40TQ-S24	121.40	127	63	25							●	●	●	●	●		40

Note: 1. Input the bore diameter in the white □□ boxes after the model number, and configuration A or B in the black ■ box. ● circles indicate applicable bore diameters.
2. The dimensions shown in this catalog are nominal dimensions and differ from actual dimensions.

RS35 Lock Series (S Type)

■ Dimensions

All models feature hardened teeth.

Model Number	Pitch Circle Dia. <i>D_P</i>	(Outer Dia.) <i>(D_O)</i>	Hub Dia. <i>D_H</i>	Hub Length <i>L</i>	Applicable Bore Dia. <i>d</i>						No. of Teeth
					24	25	28	30	32	35	
※RS35-1B19TQ-S33□□A	57.87	63	47	20	●	●	●				19
RS35-1B20TQ-S33□□■	60.89	66	50	20	●	●	●				20
RS35-1B21TQ-S34□□■	63.91	69	53	20	●	●	●				21
RS35-1B22TQ-S44□□■	66.93	72	53	20	●	●	●	●	●	●	22
RS35-1B23TQ-S44□□■	69.95	75	53	20	●	●	●	●	●	●	23
RS35-1B24TQ-S44□□■	72.97	78	53	20	●	●	●	●	●	●	24
RS35-1B25TQ-S44□□■	76.00	81	53	20	●	●	●	●	●	●	25
RS35-1B26TQ-S44□□■	79.02	84	53	22	●	●	●	●	●	●	26
RS35-1B27TQ-S44□□■	82.05	87	53	22	●	●	●	●	●	●	27
RS35-1B28TQ-S44□□■	85.07	90	53	22	●	●	●	●	●	●	28
RS35-1B30TQ-S44□□■	91.12	96	53	22	●	●	●	●	●	●	30
RS35-1B32TQ-S44□□■	97.18	102	53	22	●	●	●	●	●	●	32
RS35-1B34TQ-S44□□■	103.23	109	53	22	●	●	●	●	●	●	34
RS35-1B35TQ-S44□□■	106.26	112	53	22	●	●	●	●	●	●	35
RS35-1B36TQ-S44□□■	109.29	115	53	22	●	●	●	●	●	●	36
RS35-1B38TQ-S44□□■	115.34	121	63	25	●	●	●	●	●	●	38
RS35-1B40TQ-S44□□■	121.40	127	63	25	●	●	●	●	●	●	40

Note: 1. Input the bore diameter in the white □□ boxes after the model number, and configuration A or B in the black ■ box. ● circles indicate applicable bore diameters.

2. Models with asterisks * indicate that only configuration A is available.

3. The dimensions shown in this catalog are nominal dimensions and differ from actual dimensions.

■ RS35 Lock Series (S Type) Maximum Allowable Torque

(Unit: N·m)

Bore dia. No. of teeth	10	11	12	14	15	16	17	18	19	20	22	24	25	28	30	32	35	
	15T																	
16T	58																	
17T		63																
18T			69	81	86	92												
19T							158	167	177	186	205							
20T												167	174	195				
21T																		
22-40T				121	130	138						223	232	260		279	298	325

RS40 Lock Series (S Type)

RS40

● Applicable chain pitch : 12.7mm ● Roller dia : 7.92mm

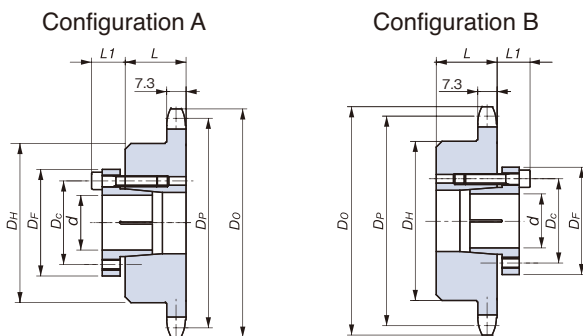

Lock Series S Type dimensions

Sleeve Model	ϕD_F (mm)	ϕD_C (mm)	L_1 (mm)	Bolt Size (M x S)	Tightening Torque (N·m)
S1	32.0	24.0	12.0	M4 x 16	4.2
S2	42.0	32.0	14.0	M5 x 18	8.3
S3	48.0	38.5	15.5	M5 x 20	8.3
S4	56.0	46.0	15.5	M5 x 20	8.3
S5	66.0	56.0	17.5	M5 x 22	8.3
S6	80.0	68.0	21.0	M6 x 25	16.8
S7	101.0	86.0	24.5	M8 x 30	40.5

Model Numbering Example

RS40-1B21TQ-S4825

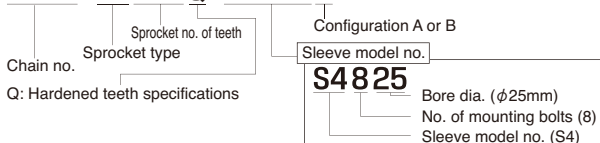

Dimensions

All models feature hardened teeth.

Model Number	Pitch Circle Dia. D_P	(Outer Dia.) (D_O)	Hub Dia. D_H	Hub Length L	Applicable Bore Dia. d								No. of Teeth	
					14	15	16	17	18	19	20	22		
RS40-1B14TQ-S16	57.07	63	42	22	●									14
RS40-1B14TQ-S24						●								
RS40-1B15TQ-S16	61.08	67	46	22		●								15
RS40-1B15TQ-S24							●							
RS40-1B16TQ-S16	65.10	71	50	22			●							16
RS40-1B16TQ-S24								●						
RS40-1B17TQ-S24	69.12	76	54	22				●						17
RS40-1B18TQ-S24	73.14	80	57	22					●					18
RS40-1B19TQ-S24	77.16	84	62	22						●				19
RS40-1B20TQ-S25	81.18	88	67	25							●			20
RS40-1B21TQ-S25	85.21	92	71	25								●		21
RS40-1B22TQ-S25	89.24	96	75	25									●	22
RS40-1B23TQ-S25	93.27	100	77	25										23
RS40-1B24TQ-S25	97.30	104	63	25										24
RS40-1B25TQ-S25	101.33	108	63	25										25
RS40-1B26TQ-S25	105.36	112	63	25										26
RS40-1B27TQ-S25	109.40	116	63	25										27
RS40-1B28TQ-S25	113.43	120	63	25										28
RS40-1B30TQ-S25	121.50	128	63	25										30
RS40-1B32TQ-S25	129.57	137	68	28										32

Note: 1. Input the bore diameter in the white □□ boxes after the model number, and configuration A or B in the black ■ box. ● circles indicate applicable bore diameters.
 2. The dimensions shown in this catalog are nominal dimensions and differ from actual dimensions.

RS40 Lock Series (S Type)

Before Use

Standard Roller Chains

Lube-Free Roller Chains

Heavy Duty Roller Chains

Corrosion Resistant Roller Chains

Specialty Roller Chains

Sprockets

Pin Gear Drives

Accessories

Selection

Handling

■ Dimensions

All models feature hardened teeth.

Model Number	Pitch Circle Dia. <i>D_P</i>	(Outer Dia.) <i>(D_O)</i>	Hub Dia. <i>(D_H)</i>	Hub Length <i>L</i>	Applicable Bore Dia. <i>d</i>										No. of Teeth	
					24	25	28	30	32	35	38	40	42	45		
*RS40-1B15TQ-S33□□□A	61.08	67	46	22	●	●	●									15
RS40-1B16TQ-S33□□□■	65.10	71	50	22	●	●	●									16
RS40-1B17TQ-S44□□□■	69.12	76	54	22	●	●	●	●	●	●						17
RS40-1B18TQ-S44□□□■	73.14	80	57	22	●	●	●	●	●	●						18
RS40-1B19TQ-S44□□□■	77.16	84	62	22	●	●	●	●	●	●						19
RS40-1B20TQ-S48□□□■	81.18	88	67	25	●	●	●	●	●	●						20
RS40-1B21TQ-S48□□□■	85.21	92	71	25	●	●	●	●	●	●	●					21
RS40-1B21TQ-S56□□□■	85.21	92	71	25							●	●	●	●		21
RS40-1B22TQ-S48□□□■	89.24	96	75	25	●	●	●	●	●	●						22
RS40-1B22TQ-S56□□□■	89.24	96	75	25							●	●	●	●		22
RS40-1B23TQ-S48□□□■	93.27	100	77	25	●	●	●	●	●	●						23
RS40-1B23TQ-S56□□□■	93.27	100	77	25							●	●	●	●		23
RS40-1B24TQ-S48□□□■	97.30	104	63	25	●	●	●	●	●	●						24
RS40-1B24TQ-S56□□□■	97.30	104	63	25							●	●	●	●		24
RS40-1B25TQ-S48□□□■	101.33	108	63	25	●	●	●	●	●	●						25
RS40-1B25TQ-S56□□□■	101.33	108	63	25							●	●	●	●		25
RS40-1B26TQ-S48□□□■	105.36	112	63	25	●	●	●	●	●	●						26
RS40-1B26TQ-S56□□□■	105.36	112	63	25							●	●	●	●		26
RS40-1B27TQ-S48□□□■	109.40	116	63	25	●	●	●	●	●	●						27
RS40-1B27TQ-S56□□□■	109.40	116	63	25							●	●	●	●		27
RS40-1B28TQ-S48□□□■	113.43	120	63	25	●	●	●	●	●	●						28
RS40-1B28TQ-S56□□□■	113.43	120	63	25							●	●	●	●		28
RS40-1B30TQ-S48□□□■	121.50	128	63	25	●	●	●	●	●	●						30
RS40-1B30TQ-S56□□□■	121.50	128	63	25							●	●	●	●		30
RS40-1B32TQ-S48□□□■	129.57	137	68	28	●	●	●	●	●	●						32
RS40-1B32TQ-S56□□□■	129.57	137	68	28							●	●	●	●		32
RS40-1B34TQ-S48□□□■	137.64	145	68	28	●	●	●	●	●	●						34
RS40-1B34TQ-S56□□□■	137.64	145	68	28							●	●	●	●		34
RS40-1B35TQ-S48□□□■	141.68	149	68	28	●	●	●	●	●	●						35
RS40-1B35TQ-S56□□□■	141.68	149	68	28							●	●	●	●		35
RS40-1B36TQ-S48□□□■	145.72	153	68	28	●	●	●	●	●	●						36
RS40-1B36TQ-S56□□□■	145.72	153	68	28							●	●	●	●		36
RS40-1B38TQ-S48□□□■	153.79	161	68	28	●	●	●	●	●	●						38
RS40-1B38TQ-S56□□□■	153.79	161	68	28							●	●	●	●		38
RS40-1B40TQ-S48□□□■	161.87	169	68	28	●	●	●	●	●	●						40
RS40-1B40TQ-S56□□□■	161.87	169	68	28							●	●	●	●		40

- Note: 1. Input the bore diameter in the white □□ boxes after the model number, and configuration A or B in the black ■ box. ● circles indicate applicable bore diameters.
- 2. Models with asterisks * indicate that only configuration A is available.
- 3. The dimensions shown in this catalog are nominal dimensions and differ from actual dimensions.

■ RS40 Lock Series (S Type) Maximum Allowable Torque (Unit: N·m)

No. of teeth	14	15	16	17	18	19	20	22	24	25	28	30	32	35	38	40	42	45
14T																		
15T	121																	
16T		139	149	158	167	177	186	205	167	174	195							
17T																		
18T									223	232	260	279	298	325				
19T																		
20T																		
21T																		
22T		174	186															
23T																		
24T				198	209	221	232	256										
25T									446	465	521	558	595	651	530	558	586	628
26T																		
27T																		
28T																		
30T																		
32T																		
34-40T																		

RS50 Lock Series (S Type)

RS50

● Applicable chain pitch : 15.875mm ● Roller dia : 10.16mm

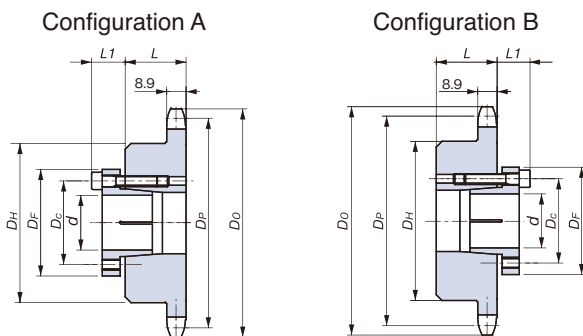

Lock Series S Type dimensions

Sleeve Model	ϕD_F (mm)	ϕD_C (mm)	L_1 (mm)	Bolt Size (M x S)	Tightening Torque (N·m)
S1	32.0	24.0	12.0	M4 x 16	4.2
S2	42.0	32.0	14.0	M5 x 18	8.3
S3	48.0	38.5	15.5	M5 x 20	8.3
S4	56.0	46.0	15.5	M5 x 20	8.3
S5	66.0	56.0	17.5	M5 x 22	8.3
S6	80.0	68.0	21.0	M6 x 25	16.8
S7	101.0	86.0	24.5	M8 x 30	40.5

Model Numbering Example

RS50-1B20TQ-S4828

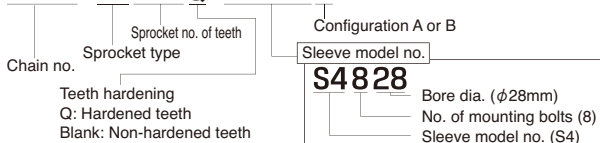

Dimensions

Teeth hardened up to 35T.

Model Number	Pitch Circle Dia. D_P	(Outer Dia.) (D_O)	Hub Dia. D_H	Hub Length L	Applicable Bore Dia. d										No. of Teeth		
					15	16	17	18	19	20	22	24	25	28		30	
RS50-1B14TQ-S25 <input type="checkbox"/> <input type="checkbox"/> <input type="checkbox"/> <input checked="" type="checkbox"/>	71.34	79	52	25	●	●											14
RS50-1B14TQ-S26 <input type="checkbox"/> <input type="checkbox"/> <input type="checkbox"/> <input type="checkbox"/>																	
RS50-1B15TQ-S25 <input type="checkbox"/> <input type="checkbox"/> <input type="checkbox"/> <input checked="" type="checkbox"/>					●	●											
RS50-1B15TQ-S26 <input type="checkbox"/> <input type="checkbox"/> <input type="checkbox"/> <input type="checkbox"/>	76.35	84	57	25			●	●	●	●	●						15
RS50-1B15TQ-S44 <input type="checkbox"/> <input type="checkbox"/> <input type="checkbox"/> <input checked="" type="checkbox"/>												●	●	●	●		
RS50-1B16TQ-S25 <input type="checkbox"/> <input type="checkbox"/> <input type="checkbox"/> <input checked="" type="checkbox"/>					●	●											
RS50-1B16TQ-S26 <input type="checkbox"/> <input type="checkbox"/> <input type="checkbox"/> <input type="checkbox"/>	81.37	89	62	25			●	●	●	●	●						16
RS50-1B16TQ-S44 <input type="checkbox"/> <input type="checkbox"/> <input type="checkbox"/> <input checked="" type="checkbox"/>												●	●	●	●		
RS50-1B17TQ-S26 <input type="checkbox"/> <input type="checkbox"/> <input type="checkbox"/> <input checked="" type="checkbox"/>										●	●						
RS50-1B17TQ-S48 <input type="checkbox"/> <input type="checkbox"/> <input type="checkbox"/> <input checked="" type="checkbox"/>	86.39	94	67	25								●	●	●	●		17
RS50-1B18TQ-S26 <input type="checkbox"/> <input type="checkbox"/> <input type="checkbox"/> <input type="checkbox"/>											●						
RS50-1B18TQ-S48 <input type="checkbox"/> <input type="checkbox"/> <input type="checkbox"/> <input checked="" type="checkbox"/>	91.42	100	72	28								●	●	●	●		18
RS50-1B19TQ-S26 <input type="checkbox"/> <input type="checkbox"/> <input type="checkbox"/> <input checked="" type="checkbox"/>												●					
RS50-1B19TQ-S48 <input type="checkbox"/> <input type="checkbox"/> <input type="checkbox"/> <input checked="" type="checkbox"/>	96.45	105	73	28									●	●	●	●	19
RS50-1B20TQ-S48 <input type="checkbox"/> <input type="checkbox"/> <input type="checkbox"/> <input checked="" type="checkbox"/>	101.48	110	73	28									●	●	●	●	20
RS50-1B21TQ-S48 <input type="checkbox"/> <input type="checkbox"/> <input type="checkbox"/> <input checked="" type="checkbox"/>	106.51	115	73	28									●	●	●	●	21
RS50-1B22TQ-S48 <input type="checkbox"/> <input type="checkbox"/> <input type="checkbox"/> <input checked="" type="checkbox"/>	111.55	120	73	28									●	●	●	●	22
RS50-1B23TQ-S48 <input type="checkbox"/> <input type="checkbox"/> <input type="checkbox"/> <input checked="" type="checkbox"/>	116.59	125	73	28									●	●	●	●	23
RS50-1B24TQ-S48 <input type="checkbox"/> <input type="checkbox"/> <input type="checkbox"/> <input checked="" type="checkbox"/>	121.62	130	73	28									●	●	●	●	24
RS50-1B25TQ-S48 <input type="checkbox"/> <input type="checkbox"/> <input type="checkbox"/> <input checked="" type="checkbox"/>	126.66	135	73	28									●	●	●	●	25
RS50-1B26TQ-S48 <input type="checkbox"/> <input type="checkbox"/> <input type="checkbox"/> <input checked="" type="checkbox"/>	131.70	140	73	28									●	●	●	●	26
RS50-1B27TQ-S48 <input type="checkbox"/> <input type="checkbox"/> <input type="checkbox"/> <input checked="" type="checkbox"/>	136.74	145	73	28									●	●	●	●	27
RS50-1B28TQ-S48 <input type="checkbox"/> <input type="checkbox"/> <input type="checkbox"/> <input checked="" type="checkbox"/>	141.79	150	73	28										●	●	●	28
RS50-1B30TQ-S48 <input type="checkbox"/> <input type="checkbox"/> <input type="checkbox"/> <input checked="" type="checkbox"/>	151.87	161	73	28										●	●	●	30
RS50-1B32TQ-S48 <input type="checkbox"/> <input type="checkbox"/> <input type="checkbox"/> <input checked="" type="checkbox"/>	161.96	171	73	28										●	●	●	32
RS50-1B34TQ-S48 <input type="checkbox"/> <input type="checkbox"/> <input type="checkbox"/> <input checked="" type="checkbox"/>	172.05	181	73	28											●	●	34

Note: 1. Input the bore diameter in the white boxes after the model number, and configuration A or B in the black box. ● circles indicate applicable bore diameters.
 2. The dimensions shown in this catalog are nominal dimensions and differ from actual dimensions.

RS50 Lock Series (S Type)

■ Dimensions

Teeth hardened up to 35T.

Model Number	Pitch Circle Dia. <i>D_P</i>	(Outer Dia.) <i>(D_O)</i>	Hub Dia. <i>D_H</i>	Hub Length <i>L</i>	Applicable Bore Dia. <i>d</i>									No. of Teeth						
					32	35	38	40	42	45	48	50	55							
RS50-1B15TQ-S44	76.35	84	57	25	●	●														15
RS50-1B16TQ-S44	81.37	89	62	25	●	●														16
RS50-1B17TQ-S48	86.39	94	67	25	●	●														17
RS50-1B17TQ-S56						●	●	●	●											
RS50-1B18TQ-S48	91.42	100	72	28	●	●														18
RS50-1B18TQ-S56						●	●	●	●											
RS50-1B19TQ-S48	96.45	105	73	28	●	●														19
RS50-1B19TQ-S56						●	●	●	●											
RS50-1B20TQ-S48	101.48	110	73	28	●	●														20
RS50-1B20TQ-S56						●	●	●	●											
RS50-1B21TQ-S48	106.51	115	73	28	●	●														21
RS50-1B21TQ-S56						●	●	●	●											
RS50-1B22TQ-S48	111.55	120	73	28	●	●														22
RS50-1B22TQ-S56						●	●	●	●											
RS50-1B23TQ-S48	116.59	125	73	28	●	●														23
RS50-1B23TQ-S56						●	●	●	●											
RS50-1B24TQ-S48	121.62	130	73	28	●	●														24
RS50-1B24TQ-S56						●	●	●	●											
RS50-1B25TQ-S48	126.66	135	73	28	●	●														25
RS50-1B25TQ-S56						●	●	●	●											
RS50-1B26TQ-S48	131.70	140	73	28	●	●														26
RS50-1B26TQ-S56						●	●	●	●											
RS50-1B27TQ-S48	136.74	145	73	28	●	●														27
RS50-1B27TQ-S56						●	●	●	●											
RS50-1B28TQ-S48	141.79	150	73	28	●	●														28
RS50-1B28TQ-S56						●	●	●	●											
RS50-1B30TQ-S48	151.87	161	73	28	●	●														30
RS50-1B30TQ-S56						●	●	●	●											
RS50-1B32TQ-S48	161.96	171	73	28	●	●														32
RS50-1B32TQ-S56						●	●	●	●											
RS50-1B34TQ-S48	172.05	181	73	28	●	●														34
RS50-1B34TQ-S56						●	●	●	●											
RS50-1B35TQ-S48	177.10	186	73	28	●	●														35
RS50-1B35TQ-S56						●	●	●	●											
RS50-1B36T-S510	182.15	191	83	35																36
RS50-1B36T-S66						●	●	●	●											
RS50-1B38T-S510	192.24	201	83	35																38
RS50-1B38T-S66						●	●	●	●											
RS50-1B40T-S510	202.33	211	83	35																40
RS50-1B40T-S66						●	●	●	●											

Note: 1. Input the bore diameter in the white □□ boxes after the model number, and configuration A or B in the black ■ box. ● circles indicate applicable bore diameters.
2. The dimensions shown in this catalog are nominal dimensions and differ from actual dimensions.

■ RS50 Lock Series (S Type) Maximum Allowable Torque

(Unit: N·m)

No. of teeth	Bore dia.																				
	15	16	17	18	19	20	22	24	25	28	30	32	35	38	40	42	45	48	50	55	
14T																					
15T	174	186	237	251	265	279															
16T							307														
17T																					
18T																					
19T																					
20T																					
21T																					
22T								446													
23T																					
24T									465	521											
25T											558										
26T												595	651								
27T														530	558	586	628				
28T																					
30T																					
32T																					
34T																					
35T																					
36-40T															883	930	976	1046	1116	1162	1279

RS60 Lock Series (S Type)

RS60

● Applicable chain pitch : 19.05mm ● Roller dia : 11.91mm

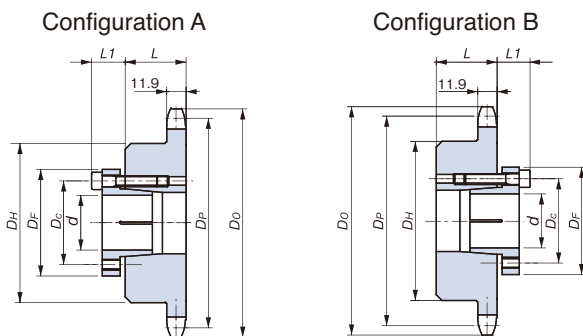

Lock Series S Type dimensions

Sleeve Model	ϕD_F (mm)	ϕD_C (mm)	L_1 (mm)	Bolt Size (M x S)	Tightening Torque (N·m)
S1	32.0	24.0	12.0	M4 × 16	4.2
S2	42.0	32.0	14.0	M5 × 18	8.3
S3	48.0	38.5	15.5	M5 × 20	8.3
S4	56.0	46.0	15.5	M5 × 20	8.3
S5	66.0	56.0	17.5	M5 × 22	8.3
S6	80.0	68.0	21.0	M6 × 25	16.8
S7	101.0	86.0	24.5	M8 × 30	40.5

Model Numbering Example

RS60-1B16TQ-S4828

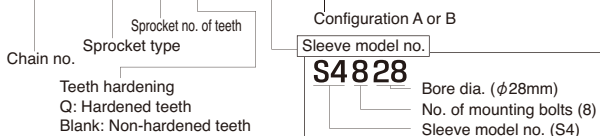

Dimensions

Teeth hardened up to 30T.

Model Number	Pitch Circle Dia. D_P	(Outer Dia.) (D_O)	Hub Dia. D_H	Hub Length L	Applicable Bore Dia. d										No. of Teeth
					18	19	20	22	24	25	28	30	32	35	
RS60-1B12TQ-S26	73.60	83	51	32	●	●	●	●							12
RS60-1B13TQ-S26	79.60	89	57	32	●	●	●	●							13
RS60-1B14TQ-S26	85.61	95	62	32	●	●	●	●							14
RS60-1B15TQ-S48	91.63	101	68	32					●	●	●	●	●	●	15
RS60-1B16TQ-S48	97.65	107	73	32					●	●	●	●	●	●	16
RS60-1B17TQ-S48	103.67	113	73	32						●	●	●	●	●	17
RS60-1B18TQ-S48	109.70	119	83	40							●	●	●	●	18
RS60-1B19TQ-S48	115.74	126	83	40							●	●	●	●	19
RS60-1B20TQ-S48	121.78	132	83	40								●	●	●	20
RS60-1B21TQ-S48	127.82	138	83	40									●	●	21
RS60-1B22TQ-S48	133.86	144	83	40										●	22
RS60-1B23TQ-S48	139.90	150	83	40										●	23
RS60-1B24TQ-S48	145.95	156	83	40										●	24
RS60-1B25TQ-S48	151.99	162	83	40										●	25

Note: 1. Input the bore diameter in the white □ boxes after the model number, and configuration A or B in the black ■ box. ● circles indicate applicable bore diameters.
2. The dimensions shown in this catalog are nominal dimensions and differ from actual dimensions.

RS60 Lock Series (S Type)

Before Use

Standard Roller Chains

Lube-Free Roller Chains

Heavy Duty Roller Chains

Corrosion Resistant Roller Chains

Specialty Roller Chains

Sprockets

Pin Gear Drives

Accessories

Selection

Handling

■ Dimensions

Teeth hardened up to 30T.

Model Number	Pitch Circle Dia. D_P	(Outer Dia.) (D_o)	Hub Dia. D_H	Hub Length L	Applicable Bore Dia. d							No. of Teeth
					38	40	42	45	48	50	55	
RS60-1B15TQ-S56□□■	91.63	101	68	32	●	●	●	●				15
RS60-1B16TQ-S56□□■	97.65	107	73	32	●	●	●	●				16
RS60-1B17TQ-S56□□■	103.67	113	73	32	●	●	●	●				17
RS60-1B18TQ-S510□□■	109.70	119	83	40	●	●	●	●				18
RS60-1B18TQ-S66□□■									●	●	●	
RS60-1B19TQ-S510□□■	115.74	126	83	40	●	●	●	●				19
RS60-1B19TQ-S66□□■									●	●	●	
RS60-1B20TQ-S510□□■	121.78	132	83	40	●	●	●	●				20
RS60-1B20TQ-S66□□■									●	●	●	
RS60-1B21TQ-S510□□■	127.82	138	83	40	●	●	●	●				21
RS60-1B21TQ-S66□□■									●	●	●	
RS60-1B22TQ-S510□□■	133.86	144	83	40	●	●	●	●				22
RS60-1B22TQ-S66□□■									●	●	●	
RS60-1B23TQ-S510□□■	139.90	150	83	40	●	●	●	●				23
RS60-1B23TQ-S66□□■									●	●	●	
RS60-1B24TQ-S510□□■	145.95	156	83	40	●	●	●	●				24
RS60-1B24TQ-S66□□■									●	●	●	
RS60-1B25TQ-S510□□■	151.99	162	83	40	●	●	●	●				25
RS60-1B25TQ-S66□□■									●	●	●	
RS60-1B26TQ-S510□□■	158.04	168	83	40	●	●	●	●				26
RS60-1B26TQ-S66□□■									●	●	●	
RS60-1B27TQ-S510□□■	164.09	174	83	40	●	●	●	●				27
RS60-1B27TQ-S66□□■									●	●	●	
RS60-1B28TQ-S510□□■	170.14	180	83	40	●	●	●	●				28
RS60-1B28TQ-S66□□■									●	●	●	
RS60-1B30TQ-S510□□■	182.25	193	83	40	●	●	●	●				30
RS60-1B30TQ-S66□□■									●	●	●	
RS60-1B32T-S510□□■	194.35	205	83	40	●	●	●	●				32
RS60-1B32T-S66□□■									●	●	●	
RS60-1B34T-S510□□■	206.46	217	83	40		●	●	●				34
RS60-1B34T-S66□□■									●	●	●	
RS60-1B35T-S510□□■	212.52	223	83	40			●	●				35
RS60-1B35T-S66□□■									●	●	●	
RS60-1B36T-S510□□■	218.57	229	83	40				●				36
RS60-1B36T-S66□□■									●	●	●	
RS60-1B38T-S510□□■	230.69	241	83	40				●				38
RS60-1B38T-S66□□■									●	●	●	
RS60-1B40T-S66□□■	242.80	253	83	40					●	●	●	40

Note: 1. Input the bore diameter in the white □□ boxes after the model number, and configuration A or B in the black ■ box. ● circles indicate applicable bore diameters.
 2. The dimensions shown in this catalog are nominal dimensions and differ from actual dimensions.

■ RS60 Lock Series (S Type) Maximum Allowable Torque

(Unit: N·m)

No. of teeth	Bore dia.																
	18	19	20	22	24	25	28	30	32	35	38	40	42	45	48	50	55
12T																	
13T	251	265	279	307													
14T					335	349	391	418	446	488							
15T																	
16T					446	465	521	558			530	558	586	628			
17T																	
18T																	
19T																	
20T																	
21T																	
22T																	
23T																	
24T											883	930	976				
25T																	
26T																	
27T														1046	1116	1162	1279
28T																	
30T																	
32T																	
34T																	
35T																	
36T																	
38T																	
40T																	

RS80 Lock Series (S Type)

RS80

● Applicable chain pitch : 25.4mm ● Roller dia : 15.88mm

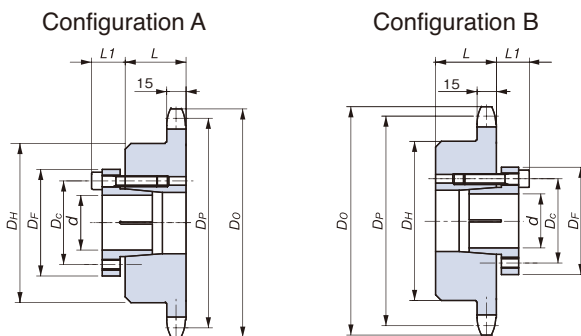

Lock Series S Type dimensions

Sleeve Model	ϕD_F (mm)	ϕD_C (mm)	L_1 (mm)	Bolt Size (M x S)	Tightening Torque (N·m)
S1	32.0	24.0	12.0	M4 x 16	4.2
S2	42.0	32.0	14.0	M5 x 18	8.3
S3	48.0	38.5	15.5	M5 x 20	8.3
S4	56.0	46.0	15.5	M5 x 20	8.3
S5	66.0	56.0	17.5	M5 x 22	8.3
S6	80.0	68.0	21.0	M6 x 25	16.8
S7	101.0	86.0	24.5	M8 x 30	40.5

Model Numbering Example

RS80-1B18TQ-S51038

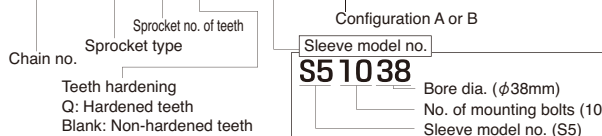

Dimensions

Teeth hardened up to 21T.

Model Number	Pitch Circle Dia. D_P	(Outer Dia.) (D_O)	Hub Dia. D_H	Hub Length L	Applicable Bore Dia. d										No. of Teeth	
					24	25	28	30	32	35	38	40	42	45		
RS80-1B12TQ-S48 <input type="checkbox"/> <input type="checkbox"/> <input checked="" type="checkbox"/>	98.14	110	67	40	●	●	●	●	●	●						12
RS80-1B13TQ-S48 <input type="checkbox"/> <input type="checkbox"/> <input checked="" type="checkbox"/>	106.14	118	77	40	●	●	●	●	●	●						13
RS80-1B13TQ-S510 <input type="checkbox"/> <input type="checkbox"/> <input checked="" type="checkbox"/>													●	●	●	●
RS80-1B14TQ-S48 <input type="checkbox"/> <input type="checkbox"/> <input checked="" type="checkbox"/>	114.15	127	77	40	●	●	●	●	●	●						14
RS80-1B14TQ-S510 <input type="checkbox"/> <input type="checkbox"/> <input checked="" type="checkbox"/>													●	●	●	●
RS80-1B15TQ-S510 <input type="checkbox"/> <input type="checkbox"/> <input checked="" type="checkbox"/>	122.17	135	93	40						●	●	●	●	●		15
RS80-1B16TQ-S510 <input type="checkbox"/> <input type="checkbox"/> <input checked="" type="checkbox"/>	130.20	143	93	40						●	●	●	●	●		16
RS80-1B17TQ-S510 <input type="checkbox"/> <input type="checkbox"/> <input checked="" type="checkbox"/>	138.23	151	93	40						●	●	●	●	●		17
RS80-1B18TQ-S510 <input type="checkbox"/> <input type="checkbox"/> <input checked="" type="checkbox"/>	146.27	159	93	40						●	●	●	●	●		18
RS80-1B19TQ-S510 <input type="checkbox"/> <input type="checkbox"/> <input checked="" type="checkbox"/>	154.32	167	93	40						●	●	●	●	●		19
RS80-1B20TQ-S510 <input type="checkbox"/> <input type="checkbox"/> <input checked="" type="checkbox"/>	162.37	176	93	40						●	●	●	●	●		20
RS80-1B21TQ-S510 <input type="checkbox"/> <input type="checkbox"/> <input checked="" type="checkbox"/>	170.42	184	93	40						●	●	●	●	●		21

Note: 1. Input the bore diameter in the white boxes after the model number, and configuration A or B in the black box. ● circles indicate applicable bore diameters.
 2. The dimensions shown in this catalog are nominal dimensions and differ from actual dimensions.

RS80 Lock Series (S Type)

■ Dimensions

Teeth hardened up to 21T.

Model Number	Pitch Circle Dia. D_P	(Outer Dia.) (D_o)	Hub Dia. D_H	Hub Length L	Applicable Bore Dia. d						No. of Teeth
					48	50	55	60	65	70	
RS80-1B15TQ-S66□□■	122.17	135	93	40	●	●	●				15
RS80-1B16TQ-S66□□■	130.20	143	93	40	●	●	●				16
RS80-1B17TQ-S66□□■	138.23	151	93	40	●	●	●				17
RS80-1B18TQ-S66□□■	146.27	159	93	40	●	●	●				18
RS80-1B19TQ-S66□□■	154.32	167	93	40	●	●	●				19
RS80-1B20TQ-S68□□■	162.37	176	93	40	●	●	●				20
RS80-1B21TQ-S68□□■	170.42	184	93	40	●	●	●				21
RS80-1B22T-S612□□■	178.48	192	107	45	●	●	●				22
RS80-1B22T-S75□□■								●	●	●	
RS80-1B23T-S612□□■	186.54	200	107	45	●	●	●				23
RS80-1B23T-S75□□■								●	●	●	
RS80-1B24T-S612□□■	194.60	208	107	45	●	●	●				24
RS80-1B24T-S75□□■								●	●	●	
RS80-1B25T-S612□□■	202.66	216	107	45	●	●	●				25
RS80-1B25T-S75□□■								●	●	●	
RS80-1B26T-S612□□■	210.72	224	107	45	●	●	●				26
RS80-1B26T-S75□□■								●	●	●	
RS80-1B27T-S612□□■	218.79	233	107	45	●	●	●				27
RS80-1B27T-S75□□■								●	●	●	
RS80-1B28T-S612□□■	226.86	241	107	45	●	●	●				28
RS80-1B28T-S75□□■								●	●	●	
RS80-1B30T-S612□□■	243.00	257	107	45	●	●	●				30
RS80-1B30T-S75□□■								●	●	●	
RS80-1B32T-S612□□■	259.14	273	107	45	●	●	●				32
RS80-1B32T-S75□□■								●	●	●	
RS80-1B34T-S612□□■	275.28	289	107	45	●	●	●				34
RS80-1B34T-S75□□■								●	●	●	
RS80-1B35T-S612□□■	283.36	297	107	45	●	●	●				35
RS80-1B35T-S75□□■								●	●	●	

Note: 1. Input the bore diameter in the white □□ boxes after the model number, and configuration A or B in the black ■ box. ● circles indicate applicable bore diameters.
2. The dimensions shown in this catalog are nominal dimensions and differ from actual dimensions.

■ RS80 Lock Series (S Type) Maximum Allowable Torque

(Unit: N·m)

Bore dia. No. of teeth	24	25	28	30	32	35	38	40	42	45	48	50	55	60	65	70
12T																
13T	446	465	521	558	595	651										
14T																
15T																
16T																
17T							883	930	976	1046	1116	1162	1279			
18T						814										
19T																
20T											1275	1329	1461			
21T																
22-35T											2232	2325	2557	2140	2319	2497

RS100 Lock Series (S Type)

RS100

● Applicable chain pitch : 31.75mm ● Roller dia : 19.05mm

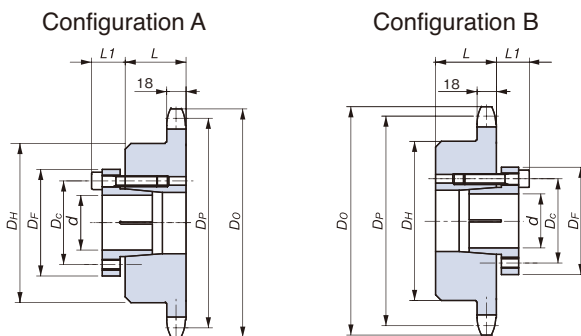

Lock Series S Type dimensions

Sleeve Model	ϕD_F (mm)	ϕD_C (mm)	L_1 (mm)	Bolt Size (M x S)	Tightening Torque (N·m)
S1	32.0	24.0	12.0	M4 × 16	4.2
S2	42.0	32.0	14.0	M5 × 18	8.3
S3	48.0	38.5	15.5	M5 × 20	8.3
S4	56.0	46.0	15.5	M5 × 20	8.3
S5	66.0	56.0	17.5	M5 × 22	8.3
S6	80.0	68.0	21.0	M6 × 25	16.8
S7	101.0	86.0	24.5	M8 × 30	40.5

Model Numbering Example

RS100-1B16TQ-S6848

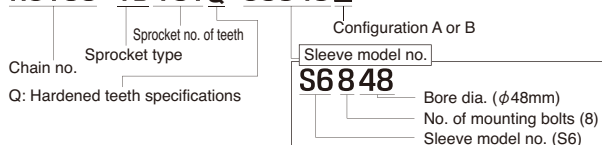

Dimensions

All models feature hardened teeth.

Model Number	Pitch Circle Dia. D_P	(Outer Dia.) (D_O)	Hub Dia. D_H	Hub Length L	Applicable Bore Dia. d						No. of Teeth
					48	50	55	60	65	70	
RS100-1B13TQ-S68	132.67	148	88	50	●	●	●				13
RS100-1B14TQ-S68	142.68	158	88	50	●	●	●				14
RS100-1B15TQ-S68	152.71	168	98	50	●	●	●				15
RS100-1B16TQ-S68	162.75	179	98	50	●	●	●				16
RS100-1B17TQ-S612	172.79	189	107	50	●	●	●				17
RS100-1B17TQ-S75								●	●	●	
RS100-1B18TQ-S612	182.84	199	107	50	●	●	●				18
RS100-1B18TQ-S75								●	●	●	
RS100-1B19TQ-S612	192.90	209	107	50	●	●	●				19
RS100-1B19TQ-S75								●	●	●	
RS100-1B20TQ-S612	202.96	220	107	50	●	●	●				20
RS100-1B20TQ-S75								●	●	●	
RS100-1B21TQ-S612	213.03	230	107	50	●	●	●				21
RS100-1B21TQ-S75								●	●	●	

Note: 1. Input the bore diameter in the white □□ boxes after the model number, and configuration A or B in the black ■ box. ● circles indicate applicable bore diameters.
2. The dimensions shown in this catalog are nominal dimensions and differ from actual dimensions.

RS100 Lock Series (S Type) Maximum Allowable Torque (Unit: N·m)

No. of teeth	48	50	55	60	65	70
13T						
14T	1488	1550	1705			
15T						
16T						
17T	2232	2325	2257	2140	2319	2497
18T						
19T						
20T						
21T						

Lock Series (with Tightening Device) N Type

Lock Sprockets are sprockets with integrated keyless friction type integrated couplings.
Available models: RS35 to RS60 1B Type sprockets



■ Features

- 1. Greatly increases work efficiency**
Unlike conventional products that require a number of tightening bolts, this type can be simply tightened with a nut and coupled to a shaft with ease. Furthermore, it can be easily dismantled for fine-adjustment and mounted again.
- 2. Suitable for small shaft diameters**
Tsubaki offers standard models with diameters ranging from 7 – 28mm to match a wide-variety of customer needs.
- 3. Compact design**
Features a compact design with strength calculations that take the maximum allowable load of the chain in mind while eliminating any waste.

■ Tightening Principle

The inner diameter of the sprocket and the outer diameter of the lock sleeve are tapered. When the mounting bolts are tightened, the sprocket will slide and move up on the tapered surface. A wedge action will generate force P and force P' in the radial direction to press on the shaft and tapered inner side, and frictional force will tightly secure the sprocket and shaft.

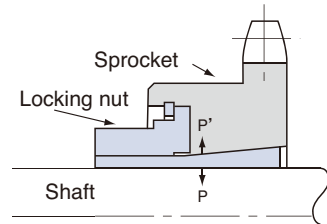

■ Direction of sprocket movement when tightening nut

When mounting a Lock Series N Type sprocket, the sprocket will move 0.2mm – 2.0mm in the direction of the shaft between the time the sprocket is initially secured and the time the sprocket is tightened. Therefore, take this movement into consideration when centering the sprocket. The amount of sprocket movement varies with type. (See the illustration on the right.)

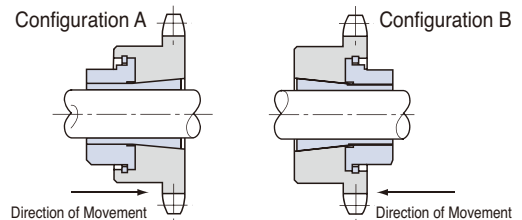

■ General Precautions

See the General Precautions for S Type on pg. 127.

■ Sleeve Mounting Configuration

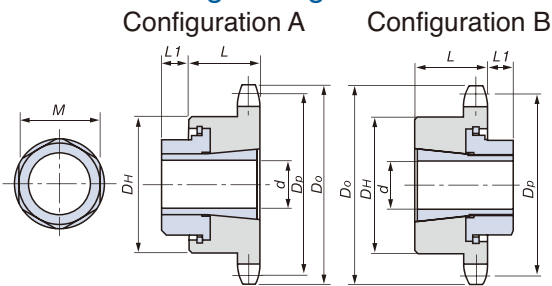

■ Ordering Example

RS40 1B 21T Q N417A

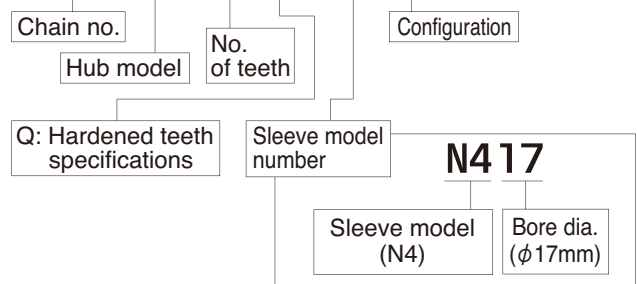

■ RS35 Lock Series N Type

●Applicable chain pitch : 9.525mm ●Roller dia : 5.08mm
All models feature hardened teeth.

No. of Teeth	Basic Dimensions		Hub		Bore dia. d	7	8	9	10	11	12	14	15	16	17	18	19	
	Pitch Circle Dia. Dp	Outer Dia. Do	Dia. DH	Length L														Max. Allowable Transmission Torque (N·m)
12	36.80	41	31	20														
13	39.80	44	32	20														
14	42.80	47	30	20														
15	45.81	51	35	20														
16	48.82	54	37	20														
17	51.84	57	41	20														
18	54.85	60	44	20														
19	57.87	63	47	20														
20	60.89	66	50	20														
21	63.91	69	53	20														
22	66.93	72	53	20														
23	69.95	75	53	20														
24	72.97	78	53	22														
25	76.00	81	53	22														
26	79.02	84	53	22														
27	82.05	87	53	22														
28	85.07	90	53	22														
30	91.12	96	53	22														
32	97.18	102	53	22														
34	103.23	109	53	22														
35	106.26	112	53	22														
36	109.29	115	53	22														
38	115.34	121	63	25														
40	121.40	127	63	25														

Note: 1. Models with 12T and asterisks * indicate that only configuration A is available.
2. The dimensions shown in this catalog are nominal dimensions and differ from actual dimensions.

●Understanding the table (Ex.) RS35 chain, Required no. of teeth: 15, Required bore dia.: 11mm
Use an N211 sleeve. "XX" in the table refers to bore diameter. Maximum transmission torque will be 46N·m.

RS35 – RS60 Lock Series (N Type)

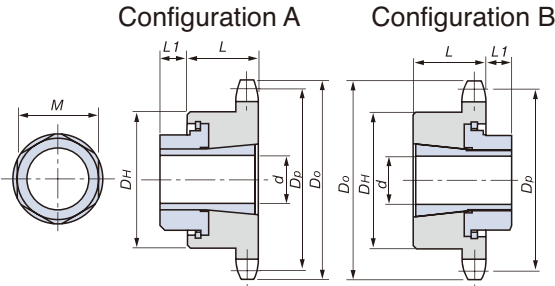

Lock Series N Type dimensions

Sleeve Model	Sleeve Protrusion L1	Nut Width Across Flats (M x S)	Nut Tightening Torque (N·m)
N1	5	18	18
N2	6	22	28
N3	8	30	65
N4	10	36	100
N5	11	41	130
N6	11	46	200

RS40 Lock Series N Type

●Applicable chain pitch : 12.7mm ●Roller dia : 7.92mm
All models feature hardened teeth.

No. of Teeth	Basic Dimensions		Hub		Bore dia. d Max. Allowable Transmission Torque (N·m)	10	11	12	14	15	16	17	18	19	20	22	24	
	Pitch Circle Dia. D_p	Outer Dia. D_o	Dia. D_H	Length L		42	46	50	104	111	119	161	171	180	214	236	257	
11	45.08	51	37	22	Suitable sleeve model and dimensions	**	**	**										
12	49.07	55	40	22														
13	53.07	59	37	22														
14	57.07	63	42	22														
15	61.08	67	46	22														
16	65.10	71	50	22														
17	69.12	76	54	22														
18	73.14	80	57	22														
19	77.16	84	62	22														
20	81.18	88	67	25														
21	85.21	92	71	25														
22	89.24	96	75	25														
23	93.27	100	77	25														
24	97.30	104	63	25														
25	101.33	108	63	25														
26	105.36	112	63	25														
27	109.40	116	63	25														
28	113.43	120	63	25														
30	121.50	128	63	25														
32	129.57	137	68	28														
34	137.64	145	68	28														
35	141.68	149	68	28														
36	145.72	153	68	28														
38	153.79	161	68	28														
40	161.87	169	68	28														

Note: 1. Models with 11 and 12T and asterisks * indicate that only configuration A is available.
2. The dimensions shown in this catalog are nominal dimensions and differ from actual dimensions.

RS50 Lock Series N Type

●Applicable chain pitch : 15.875mm ●Roller dia : 10.16mm
All models feature hardened teeth.

No. of Teeth	Basic Dimensions		Hub		Bore dia. d Max. Allowable Transmission Torque (N·m)	14	15	16	17	18	19	20	22	24
	Pitch Circle Dia. D_p	Outer Dia. D_o	Dia. D_H	Length L		104	111	119	161	171	180	214	236	257
11	56.35	64	46	25	Suitable sleeve model and dimensions	**	**	**						
12	61.34	69	51	25					**	**	**			
13	66.33	74	51	25					**	**	**			
14	71.34	79	52	25										
15	76.35	84	57	25										
16	81.37	89	62	25										
17	86.39	94	67	25										
18	91.42	100	72	28										
19	96.45	105	73	28										
20	101.48	110	73	28										
21	106.51	115	73	28										
22	111.55	120	73	28										
23	116.59	125	73	28										
24	121.62	130	73	28										
25	126.66	135	73	28										

Note: 1. Models with 11, 12, and 13T and asterisks * indicate that only configuration A is available.
2. The dimensions shown in this catalog are nominal dimensions and differ from actual dimensions.

RS60 Lock Series N Type

●Applicable chain pitch : 19.05mm ●Roller dia : 11.91mm
All models feature hardened teeth.

No. of Teeth	Basic Dimensions		Hub		Bore dia. d Max. Allowable Transmission Torque (N·m)	14	15	16	17	18	19	20	22	24	25	26	28
	Pitch Circle Dia. D_p	Outer Dia. D_o	Dia. D_H	Length L		104	111	119	161	171	180	214	236	257	370	385	415
9	55.70	64	43	32	Suitable sleeve model and dimensions	**	**	**									
10	61.65	70	49	32					**	**	**						
11	67.62	76	51	32					**	**	**						
12	73.60	83	51	32													
13	79.60	89	57	32													
14	85.61	95	62	32													
15	91.63	101	68	32													
16	97.65	107	73	32													
17	103.67	113	73	32													
18	109.70	119	83	40													
19	115.74	126	83	40													
20	121.78	132	83	40													
21	127.82	138	83	40													
22	133.86	144	83	40													
23	139.90	150	83	40													
24	145.95	156	83	40													
25	151.99	162	83	40													

Note: 1. Models with 9, 10, and 11T and asterisks * indicate that only configuration A is available.
2. The dimensions shown in this catalog are nominal dimensions and differ from actual dimensions.

Torque Limiter Sprockets

Torque limiters are typical mechanical devices for overload protection, and as such it is essential that the friction surface of the center member be finished properly to ensure the precise, accurate overload detection of the torque limiter. Dedicated sprockets for torque limiters are provided with special surface processing to realize the ideal surface finish.

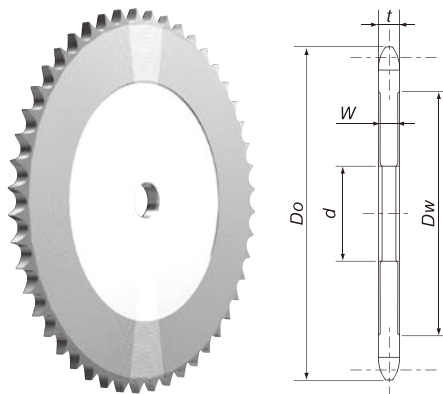

- Manufacturer's recommended value: Former JIS 3S – 6S
- Torque limiter sprocket: Ra 1.6μm and under (roughly former JIS 6S)

Model Numbering Example

RS40-1A 20T Q-CM 30

Chain no. _____ Finished bore dia. *d*
 Sprocket type (Type A) _____ Torque limiter sprocket
 No. of teeth _____ Teeth hardening
 Q: Hardened teeth
 Blank: Non-hardened teeth

Chain No.	RS40	RS50	RS60	RS80	RS100
<i>W</i>	6.5	8.0	10.5	13.5	16.5
<i>t</i>	7.3	8.9	11.9	15.0	18.0

- Operating conditions: Sprocket width > Torque limiter bush width (The sprocket width must be larger than the bush width.)
- All other dimensions are the same as those for standard 1A Type sprockets.
- Refer to the following table for the *d* and *D_w* ranges.
- Uses an H7 finished bore diameter (*d*).

Note: Be sure to check the with the torque limiter manufacturer's catalog for the dimensions of each part. Specify the model number of the torque limiter when placing your order.

■ Torque Limiter Compatibility Table (Ref.)

No. of Teeth	Applicable sprocket range <i>d</i> × <i>D_w</i>																														
	16	17	18	19	20	21	22	23	24	25	26	27	28	30	32	34	35	36	38	40	42	45	48	50							
RS40*	TL200	30 × 53																													
	TL250				41 × 68																										
	TL350												49 × 92																		
RS50	TL250		41 × 68																												
	TL350										49 × 92																				
	TL500															74 × 134															
RS60	TL350		49 × 92																												
	TL500										74 × 134																				
	TL700																105 × 184														
RS80	TL500		74 × 132																												
	TL700											105 × 184																			
RS100	TL500		74 × 132																												
	TL700											105 × 184																			

Sprockets compatible with torque limiters from every major manufacturer are available. We also offer made-to-order sprockets. Contact a Tsubaki representative for more information.

*Check the bush width if TL250 or TL350 are used with RS40 sprockets.

RS Sprocket Engineering Information

1. Part names and standard dimensional formulae

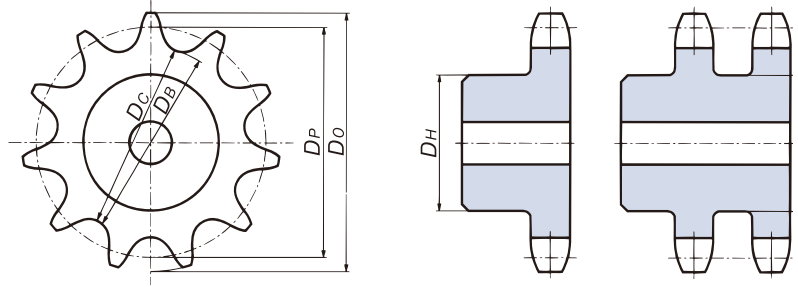

$$D_P = P / \sin \frac{180^\circ}{N}$$

$$D_O = P \left(0.6 + \cot \frac{180^\circ}{N} \right)$$

$$D_B = D_P - d_i$$

$$D_C = D_B \quad (\text{When number of teeth is even})$$

$$D_C = D_P \cos \frac{90^\circ}{N} - d_i \quad (\text{When number of teeth is odd})$$

$$D_H = P \left(\cot \frac{180^\circ}{N} - 1 \right) - 0.76$$

D_P = Pitch diameter

D_O = Standard outer diameter

D_B = Tooth root diameter

D_C = Tooth root distance

D_H = Max. hub diameter and max. groove diameter

P = Chain pitch

d_i = Roller outer diameter

N = Number of teeth

2. Tooth profile specifications

2-1. Tooth profile

Tsubaki sprocket teeth profiles use S profiles from JIS standards, and are machine hobbled. We currently are partially combining these with JIS standard U profiles.

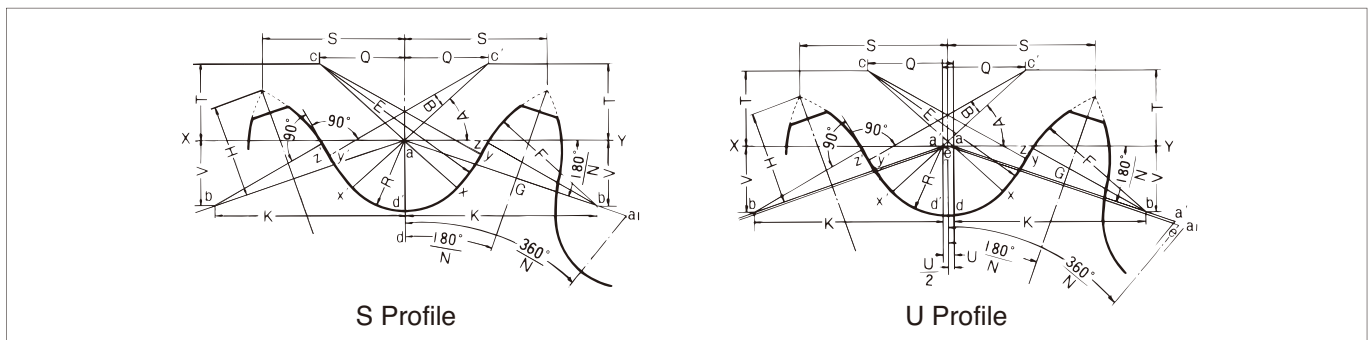

$$pa = p \left(1 + \frac{D_S - d_i}{D_P} \right)$$

$$D_S = 2R = 1.005 d_i + 0.076$$

$$U = 0.07 (p - d_i) + 0.051$$

$$R = D_S / 2 = 0.5025 d_i + 0.038$$

$$A = 35^\circ + 60^\circ / N$$

$$B = 18^\circ - 56^\circ / N$$

$$ac = 0.8 d_i$$

$$Q = 0.8 d_i \cos (35^\circ + 60^\circ / N)$$

$$T = 0.8 d_i \sin (35^\circ + 60^\circ / N)$$

$$E = cy = 1.3025 d_i + 0.038$$

$$XY = (2.605 d_i + 0.076) \sin (9^\circ - 28^\circ / N)$$

$$yz = d_i [1.4 \sin (17^\circ - 64^\circ / N) - 0.8 \sin (18^\circ - 56^\circ / N)]$$

$$G = ab = 1.4 d_i \quad [\text{Point b forms a line from point a on the XY line to the } 180^\circ / N \text{ angle on the XY line.}]$$

$$K = 1.4 d_i \cos 180^\circ / N$$

$$V = 1.4 d_i \sin 180^\circ / N$$

$$F = d_i [0.8 \cos (18^\circ - 56^\circ / N) + 1.4 \cos (17^\circ - 64^\circ / N) - 1.3025] - 0.038$$

$$H = \sqrt{F^2 - \left(1.4 d_i - \frac{pa}{2} + \frac{U}{2} \cos 180^\circ / N \right)^2} + \frac{U}{2} \sin 180^\circ / N$$

[Assuming that $U = 0$ for the S profile]

$$S = \frac{pa}{2} \cos 180^\circ / N + H \sin 180^\circ / N$$

Outer diameter when teeth profiles taper = $pa \cot 180^\circ / N + 2H$

Max. pressure angle = $x_{ab} = 35^\circ - 120^\circ / N$

Min. pressure angle = $x_{ab} - B = 17^\circ - 64^\circ / N$

Ave. pressure angle = $26^\circ - 92^\circ / N$

N = No. of teeth, d_i = Roller outer dia., D_P = Pitch diameter, p = Chain pitch, pa = Tooth profile pitch (a-a1 for S profiles, e-e1 for U profiles)

Engineering Information

2-2 Tooth width dimensions

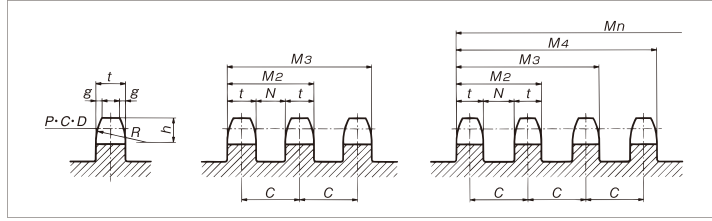

Chain No.	Each Strand			t (Max.)			C	Double/Triple Strands			Quadruple or More Strands					
	g (ref.)	h	R (min.)	Single strand	Double/triple strands	Quadruple or more strands		Double strands or more	M ₂	M ₃	N	M ₂	M ₃	M ₄	M ₅	M ₆
RS 11	0.5	1.9	4.0	1.6	—	—	—	—	—	—	—	—	—	—	—	—
RS 15	0.6	2.4	5.1	2.0	—	—	—	—	—	—	—	—	—	—	—	—
RS 25	0.8	3.2	6.8	2.9	2.8	2.8	6.4	9.2	15.6	3.6	9.2	15.6	22.0	28.4	34.8	3.6
RS 35	1.2	4.8	10.1	4.4	4.3	4.2	10.1	14.4	24.5	5.8	14.3	24.4	34.5	44.6	54.7	5.9
RS 41	1.6	6.4	13.5	5.8	—	—	—	—	—	—	—	—	—	—	—	—
RS 40	1.6	6.4	13.5	7.3	7.1	7.0	14.4	21.5	35.9	7.3	21.4	35.8	50.2	64.6	79.0	7.4
RS 50	2.0	7.9	16.9	8.9	8.7	8.6	18.1	26.8	44.9	9.4	26.7	44.8	62.9	81.0	99.1	9.5
RS 60	2.4	9.5	20.3	11.9	11.7	11.4	22.8	34.5	57.3	11.1	34.2	57.0	79.8	102.6	125.4	11.4
RS 80	3.2	12.7	27.0	15.0	14.6	14.3	29.3	43.9	73.2	14.7	43.6	72.9	102.2	131.5	160.8	15.0
RS100	4.0	15.9	33.8	18.0	17.6	17.2	35.8	53.4	89.2	18.2	53.0	88.8	124.6	160.4	196.2	18.6
RS120	4.7	19.0	40.5	24.0	23.5	23.0	45.4	68.9	114.3	21.9	68.4	113.8	159.2	204.6	250.0	22.4
RS140	5.5	22.2	47.3	24.0	23.5	23.0	48.9	72.4	121.3	25.4	71.9	120.8	169.7	218.6	267.5	25.9
RS160	6.3	25.4	54.0	30.0	29.3	28.7	58.5	87.8	146.3	29.2	87.2	145.7	204.2	262.7	321.2	29.8
RS180	7.1	28.6	60.8	33.7	33.0	32.3	65.8	98.8	164.6	32.8	98.1	163.9	229.7	295.5	361.3	33.5
RS200	8.0	31.8	67.5	36.0	35.2	34.4	71.6	106.8	178.4	36.4	106.0	177.6	249.2	320.8	392.4	37.2
RS240	9.5	38.1	81.0	45.0	44.0	43.1	87.8	131.8	219.6	43.8	130.9	218.7	306.5	394.3	482.1	44.7

Maximum sprocket hub diameter and standard maximum bore diameter

Chain No.	RS25	RS35	RS40 · 41	RS50	RS60	RS80	RS100	RS120	RS140	RS160	RS180	RS200	RS240													
Chain Pitch	6.35	9.525	12.70	15.875	19.05	25.40	31.75	38.10	44.45	50.80	57.15	63.50	76.20													
No. of Teeth	Hub dia.	Max. bore dia.	Hub dia.	Max. bore dia.	Hub dia.	Max. bore dia.	Hub dia.	Max. bore dia.	Hub dia.	Max. bore dia.	Hub dia.	Max. bore dia.	Hub dia.	Max. bore dia.	Hub dia.	Max. bore dia.	Hub dia.	Max. bore dia.	Hub dia.	Max. bore dia.	Hub dia.	Max. bore dia.	Hub dia.	Max. bore dia.		
10	12	3.2	19	8.8	26	14	32	18	39	22	52	32	65	42	78	50	92	60	105	70	118	78	131	88	158	108
11	15	5.6	22	11	30	18	37	22	45	27	60	38	76	50	91	60	106	71	121	80	137	92	152	103	183	126
12	17	7.2	25	13	34	20	43	26	51	31	69	45	86	57	103	69	121	80	138	93	155	106	173	118	207	144
13	19	8.8	28	15	38	22	48	30	57	36	77	51	96	64	116	79	135	91	155	105	174	119	193	132	232	162
14	21	10	31	17	42	26	53	33	64	41	85	57	107	72	128	85	150	101	171	117	192	132	214	148	257	180
15	23	12	35	20	46	28	58	37	70	46	93	61	117	80	140	95	164	111	187	129	211	146	235	163	282	199
16	25	13	38	21	50	31	63	41	76	51	102	68	127	85	153	104	178	122	204	141	229	159	255	179	306	216
17	27	14	41	24	54	34	68	45	82	53	110	74	137	93	165	112	193	132	220	152	248	173	275	193	331	232
18	29	16	44	26	59	37	73	49	88	59	118	80	148	100	177	121	207	144	237	165	266	186	296	208	355	252
19	31	17	47	29	63	41	79	51	94	62	126	84	158	108	189	129	221	153	253	177	284	199	316	224	380	268
20	33	19	50	30	67	44	84	55	100	66	134	90	168	114	202	140	235	163	269	188	303	213	337	238	404	283
21	35	20	53	33	71	47	89	59	107	72	142	95	178	122	214	148	250	175	285	200	321	226	357	254	429	303
22	37	21	56	35	75	50	94	62	113	77	150	101	188	128	226	157	264	185	302	212	339	239	377	266	453	318
23	39	22	59	37	79	51	99	65	119	80	159	109	199	137	238	165	278	196	318	224	358	254	398	278	477	338
24	41	24	62	40	83	54	104	70	125	83	167	113	209	144	251	176	292	205	334	235	376	265	418	294	502	354
25	43	25	65	42	87	57	109	73	131	88	175	120	219	152	263	184	307	217	351	249	394	275	438	310	526	372

Note: When selecting max. bore diameter, select a hub wall thickness that matches the operating conditions based on standard machine design. Standard-type max. bore diameters for standard situations (SS400 sprocket, JIS keyway) are shown for your reference. The values have been calculated using JIS hub diameter formulae.

Chain-type Pin Gears

For linear drive and large radius rotary drives, a chain gear drive is used by a drive source (motor, etc.) through a reducer. Chains require a large space, and gears need precision machining, which can lead to high costs and other issues. Pins gears are perfect in these situations.

An attachment chain is wound around the outside of a drum in place of a gear drive wheel, and a specially machined sprocket is used for the pinion gear. For linear drives, the attachment chain is attached linearly and used in place of a rack.

The following is a rough comparison of pin gears and gear racks.

	Freedom of Layout	Precision	Cost	Durability
Pin Gears	Excellent	OK	Good	Good
Gear Racks	Poor	Good	OK	OK

● Pin Gear Drive Types

There are linear, inner rotary, and outer rotary pin gear drives.

Linear

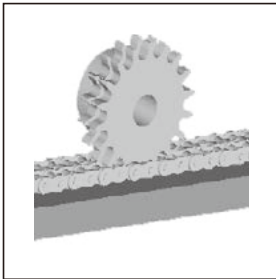

Inner rotary

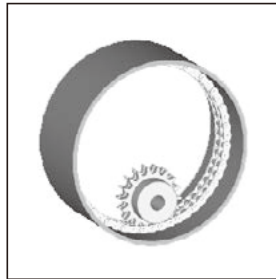

Outer rotary



Sprockets for Chain-type Pin Gears

Unlike sprockets where the chain wraps around them, sprockets for pin gears engage the chain, which requires them to have special teeth profiles. Using a unique principle, Tsubaki's special tooth profiles are designed for the lowest possible backlash and enable smooth engagement. Especially, the tooth profile changes to match the mounting diameter of the pin gear chain in inner/outer rotary applications for the optimal pin gear drive.

Contact a Tsubaki representative for more information.

● Reference Dimensions

Reference values for pin gear sprockets by number of teeth.

(Unit : mm)

Tooth Width	RS40		RS50		RS60		RS80		RS100		RS120		RS140		RS160	
	Pitch Diameter D_P	Outer Diameter D_o	Pitch Diameter D_P	Outer Diameter D_o	Pitch Diameter D_P	Outer Diameter D_o	Pitch Diameter D_P	Outer Diameter D_o	Pitch Diameter D_P	Outer Diameter D_o	Pitch Diameter D_P	Outer Diameter D_o	Pitch Diameter D_P	Outer Diameter D_o	Pitch Diameter D_P	Outer Diameter D_o
15	62.29	70.9	77.77	88.1	93.32	106.3	124.17	141.8	155.09	177.9	186.11	212.8	216.94	247.7	247.94	282.2
16	66.33	75.1	82.82	93.3	99.38	112.6	132.26	150.1	165.19	188.1	198.23	224.9	231.09	261.6	264.11	298.4
17	70.37	79.3	87.87	98.6	105.545	119.0	140.34	158.6	175.30	198.2	210.36	237.0	245.24	275.7	280.28	314.6
18	74.42	83.5	92.93	103.9	111.51	125.3	148.43	167.1	185.41	208.3	222.49	249.2	259.39	289.9	296.45	330.7
19	78.46	87.8	97.98	109.1	117.57	131.5	156.51	175.4	195.51	218.4	234.62	261.3	273.54	304.0	312.62	346.9
20	82.50	92.0	103.03	114.3	123.64	137.9	164.60	183.7	205.62	228.5	246.74	273.4	287.69	318.2	328.79	363.1
21	86.54	96.0	108.09	119.6	129.70	144.0	172.68	191.7	215.73	238.6	258.87	285.5	301.84	332.3	344.96	379.3
22	90.56	100.1	113.14	124.9	135.77	150.1	180.77	199.8	225.83	248.7	271.00	297.7	315.99	346.5	361.13	395.4
23	94.63	104.1	118.19	130.2	141.83	156.1	188.85	207.9	235.94	258.8	283.13	309.8	330.14	360.6	377.30	411.6
24	98.67	108.2	123.24	135.4	147.89	162.2	196.94	216.0	246.04	268.9	295.25	321.9	344.28	374.8	393.47	427.8
25	102.71	112.2	128.30	140.5	153.96	168.2	205.02	224.1	256.15	279.0	307.38	334.1	358.43	388.9	409.64	443.9

■ Model Numbering Example

See pg. 193 for selection.

RS80-1B 18T Q G

Chain no.	No. of teeth	Chain-type pin gear
Sprocket type	Q: Hardened teeth specifications	

Attachment Chains for Chain-type Pin Gears

K1 Attachment

SK1 Attachment

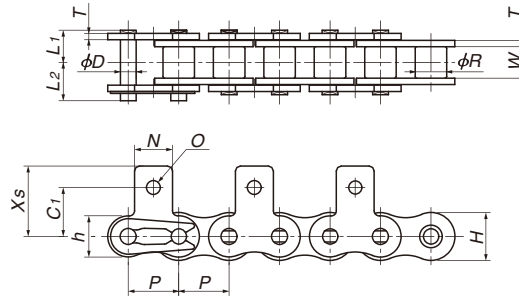
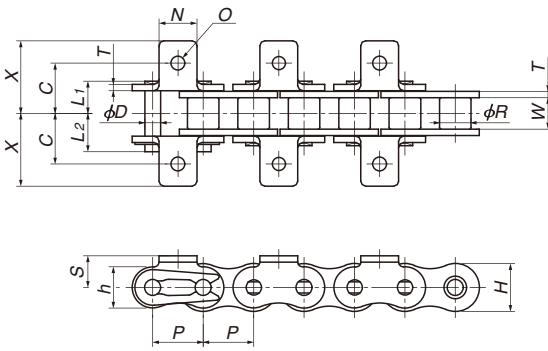

Connecting Links

RS40 – RS60: Clip type
RS80 – RS200: Cotter pin type
RS240: Spring pin type

Attachment dimensions are all common to standard K1 and SK1 attachment chains. (See the Tsubaki Small Size Conveyor Chain catalog for more information.)

TSUBAKI Chain Number	Pitch P	Roller Diameter R	Inner Link Inner Width W	Plate			Pin			Average Tensile Strength kN{kgf}	Maximum Allowable Load kN{kgf}	Approximate Mass kg/m
				Thickness T	Width H	Width h	Dia. D	L1	L2			
RS40	12.70	7.92	7.95	1.5	12.0	10.4	3.97	8.25	9.95	16.7{1700}	2.16{220}	0.64
RS50	15.875	10.16	9.53	2.0	15.0	13.0	5.09	10.3	12.0	27.5{2800}	4.12{420}	1.04
RS60	19.05	11.91	12.70	2.4	18.1	15.6	5.96	12.85	14.75	40.2{4100}	4.90{500}	1.53
RS80	25.40	15.88	15.88	3.2	24.1	20.8	7.94	16.25	19.25	68.6{7000}	9.41{960}	2.66
RS100	31.75	19.05	19.05	4.0	30.1	26.0	9.54	19.75	22.85	108{11000}	15.7{1600}	3.99
RS120	38.10	22.23	25.40	4.8	36.2	31.2	11.11	24.9	28.90	151{15400}	20.6{2100}	5.93
RS140	44.45	25.40	25.40	5.6	42.2	36.4	12.71	26.9	31.70	204{20800}	29.4{3000}	7.49
RS160	50.80	28.58	31.75	6.4	48.2	41.6	14.29	31.85	36.85	258{26300}	37.3{3800}	10.10
RS200	63.50	39.68	38.10	8.0	60.3	52.0	19.85	39.0	44.80	431{44000}	46.1{4700}	16.49
RS240	76.20	47.63	47.63	9.5	72.4	62.4	23.81	47.9	55.50	667{68000}	68.6{7000}	24.50

TSUBAKI Chain Number	Attachment							K1/SK1 Additional Weight per Attachment Location kg	Number of Links per Unit	Delivery
	C	C1	N	O	S	X	Xs			
RS40	12.7	12.7	9.5	3.6	8.0	17.8	17.40	0.004	240	Contact a Tsubaki representative.
RS50	15.9	15.9	12.7	5.2	10.3	23.4	23.05	0.006	192	
RS60	19.05	18.3	15.9	5.2	11.9	28.2	26.85	0.014	160	
RS80	25.4	24.6	19.1	6.8	15.9	36.6	35.45	0.026	120	
RS100	31.75	31.8	25.4	8.7	19.8	44.9	44.00	0.052	96	
RS120	38.1	36.5	28.6	10.3	23.0	55.8	52.85	0.088	80	
RS140	44.5	44.5	34.9	11.9	28.6	63.1	63.50	0.142	68	
RS160	50.8	50.8	38.1	14.3	31.8	71.8	70.10	0.194	60	
RS200	63.5	63.5	48.0	17.5	42.9	83.5	85.50	0.356	48	
RS240	76.2	76.2	57.2	21.0	47.7	97.9	106.70	0.553	40	

Note: 1. Use heat treated mounting bolts. (See pg. 182 for selection.)
2. The dimensions shown in this catalog are nominal dimensions and differ from actual dimensions.

Model Numbering Example

See pg. 193 for selection.

RS80-2L K1



Before Use | Standard Roller Chains | Lubrication-Free Roller Chains | Heavy Duty Roller Chains | Corrosion Resistant Roller Chains | Specialty Roller Chains | Sprackets | Pin Gear Drives | Accessories | Selection | Handling

Attachment Chains for Chain-type Pin Gears

WK2 Attachment

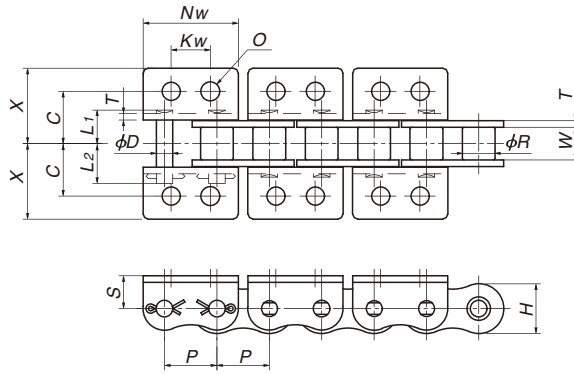

1. Attachment hole diameter is larger than that of K1 attachment chain, and bolt strength is greater.
2. Attachment strength is greater than that of K1 attachment chain.
3. RS200 and RS240 chains use flat plates.
4. Spring pins are used with RS240 connecting links.
5. Made-to-order item.

Note: 1. Attachment dimensions are all common to standard WK2 attachment chains. (See the Tsubaki Small Size Conveyor Chain catalog for more information.)
 2. The dimensions shown in this catalog are nominal dimensions and differ from actual dimensions.

TSUBAKI Chain Number	Pitch P	Roller Diameter R	Inner Link Inner Width W	Plate		Pin			Average Tensile Strength kN{kgf}	Maximum Allowable Load kN{kgf}	Approximate Mass kg/m
				Thickness T	Width H	Dia. D	L ₁	L ₂			
RS40	12.70	7.92	7.95	1.5	12.0	3.97	8.25	9.95	16.7{1700}	2.65{270}	0.64
RS50	15.875	10.16	9.53	2.0	15.0	5.09	10.3	12.0	27.5{2800}	4.31{440}	1.04
RS60	19.05	11.91	12.70	2.4	18.1	5.96	12.85	14.75	40.2{4100}	6.28{640}	1.53
RS80	25.40	15.88	15.88	3.2	24.1	7.94	16.25	19.25	68.6{7000}	10.7{1090}	2.66
RS100	31.75	19.05	19.05	4.0	30.1	9.54	19.75	22.85	108{11000}	17.1{1740}	3.99
RS200	63.50	39.68	38.10	8.0	60.3	19.85	39.0	44.8	431{44000}	46.1{4700}	16.49
RS240	76.20	47.63	47.63	9.5	72.4	23.81	47.9	55.5	667{68000}	68.6{7000}	24.15

TSUBAKI Chain Number	Attachment						WK2 Additional Weight per Attachment Location kg	Number of Links per Unit	Delivery
	C	X	Nw	Kw	O	S			
RS40	12.7	17.8	23.0	9.5	4.5	8.0	0.006	240	Contact a Tsubaki representative.
RS50	15.9	23.4	28.8	11.9	5.5	10.3	0.014	192	
RS60	19.05	28.2	34.6	14.3	6.6	11.9	0.024	160	
RS80	25.4	36.6	46.1	19.1	9.0	15.9	0.056	120	
RS100	31.75	44.9	57.7	23.8	11.0	19.8	0.110	96	
RS200	63.5	83.5	115.4	63.5	17.5	42.9	0.857	48	
RS240	76.2	97.9	138.5	57.0	21.0	47.7	1.338	40	

RF320-T-K1 Attachment Chain

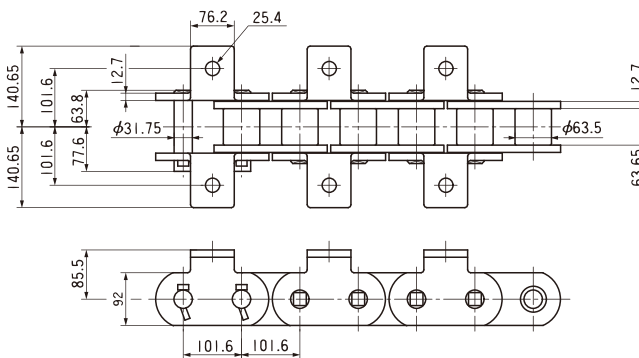

RS400-T-K1 Attachment Chain

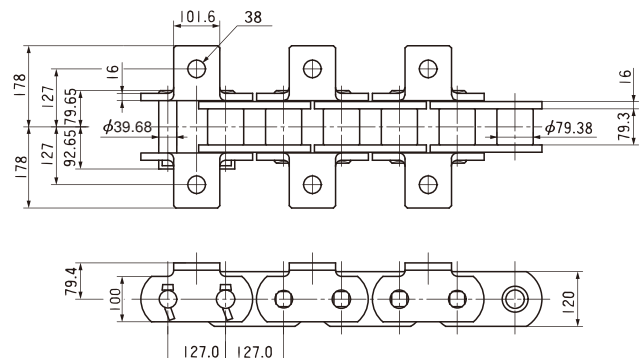

TSUBAKI Chain Number	Average Tensile Strength kN{kgf}	Maximum Allowable Load kN{kgf}	Approximate Mass kg/m	K1 Additional Weight per Attachment Location kg	Number of Links per Unit	Delivery
RF320-T	1150{117000}	104{10600}	47.6	1.732	30	Contact a Tsubaki representative.
RF400-T	1950{199000}	176{17900}	83.9	3.136	24	

Note: The dimensions shown in this catalog are nominal dimensions and differ from actual dimensions.

★See pg. 194 for selection

Pin Gear Drive Units

A new drive system to replace gears and racks.

Construction A pin gear drive unit is a drive unit with a pin gear and engaging pin rack (or pin wheel) set.

Linear Drives

Pin Rack

Pin Gear

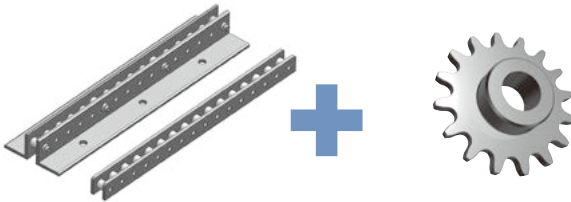

Pin wheel diameter (number of pins) can be selected freely. Pin gear and pin wheel/rack are sold together as a unit.

Rotary Drives

Pin Wheels

Pin Gears

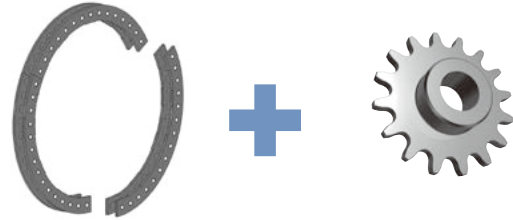

Pin rack length (number of pins) can be selected freely. Combine pin gear and pin wheel/rack to bring out its full functions and performance.

Construction

Pin gears feature special tooth profiles for smooth, continuous engagement with the rollers. Teeth have been hardened to increase their strength and wear resistance.

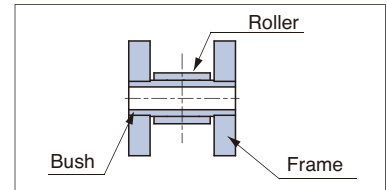
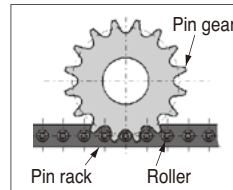

Unique Pin Gear Tooth Profile

The pin gear tooth profile is an approximation of an involute curve to provide smooth engagement and power transmission between pin wheel and rack. They also incorporate a unique Tsubaki design to give them even further strength. Tooth profile will vary depending on the application (outer drive, inner drive, linear drive).

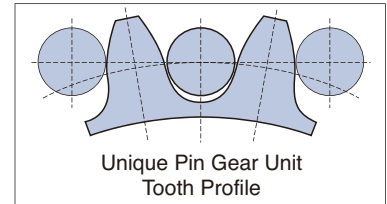

Features

Drive Method	Installation Time	Transmission Torque	Large Equipment Installation	Cost
Pin Gear Drive Unit	Good	Good	Good	Good
Standard Gear	Fair	Good	Fair	Poor
Chain Type Pin Gear	Fair	Good	Good	Excellent

Simple installation

Uses a segmented system for easy installation.
Can be used with a rough installation precision.

Large transmission torque

Pin gears provide a large transmission torque thanks to its ample modular design and excellent pin wheel/pin rack balance.

Can be used on large equipment

Can be used as a drive on large equipment just by adding more segments.

Wide selection

Tsubaki offers a Steel Type, Advanced Rust Protection type, and a Stainless Steel Type Pin Gear Drive Unit.

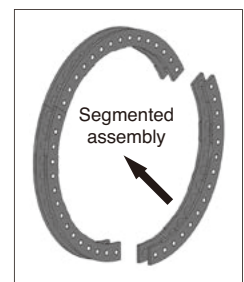

Steel Type	PDU	Versatile, high strength
Advanced Rust Protection Type	PDU-R	High strength with improved corrosion and weather resistance
Stainless Steel Type	PDUS	Excellent corrosion and heat resistance

Before Use
Standard Roller Chains
Lube-Free Roller Chains
Heavy Duty Roller Chains
Corrosion Resistant Roller Chains
Specialty Roller Chains
Sprockets
Pin Gear Drives
Accessories
Selection
Handling

Pin Gear Drive Units

Advanced Rust Protection Type Features

Improved rust resistance by combining advanced rust protection plating, coating, and paint.

Frame	Advanced rust protection plating	Special zinc and aluminum alloy plating
Rollers and bushes	Advanced rust protection coating	Special zinc and resin coating
Pin gear	Advanced rust protection paint	Special corrosion and weather resistant paint

Correlation Diagram of Allowable Tangential Load and Corrosion Resistance

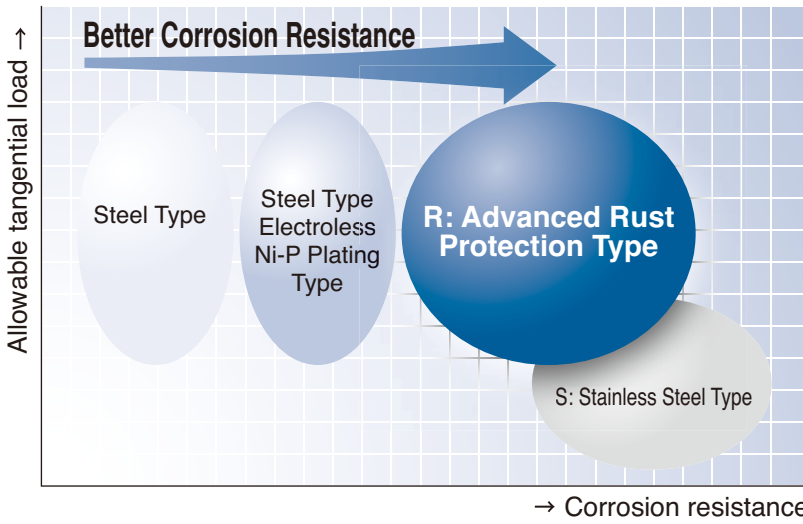

Comparison of Appearance of Red Rust in SST Tests

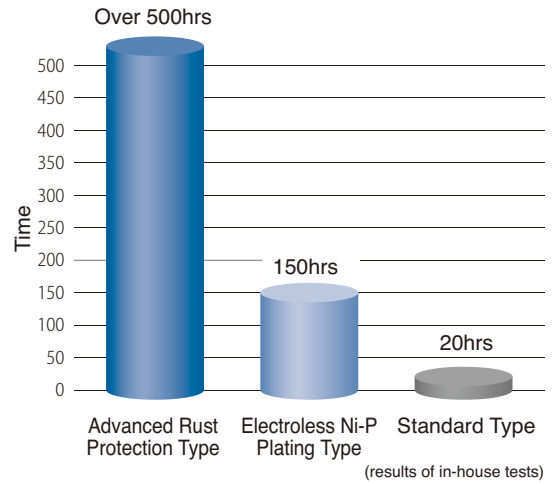

Features increased corrosion resistance while keeping the same allowable tangential load as the Steel Type thanks to its special surface treatment. Ideal for use outdoors as well.

Model Numbering Example

Pin wheel

PDU70-GW-90P-R

PDU: Type
 70: Frame no. (pitch)
 GW: Outer drive / NW: Inner drive
 90: No. of rollers
 P: Advanced Rust Protection Type
 R: Advanced Rust Protection Type
 PDU: Steel Type/Advanced Rust Protection Type
 PDUS: Stainless Steel Type

Pin wheels with partial circumferences (less than 360°) available.

The following is an example of a partial circumference (less than 360°) model number.

PDU70-GW-30/90P

30: No. of rollers needed
 90: No. of rollers over entire circumference

Pin rack

PDU70-FR-18P-R

PDU: Type
 70: Frame no. (pitch)
 FR: Flat / AR: Angled
 18: No. of rollers
 P: Advanced Rust Protection Type
 R: Advanced Rust Protection Type
 PDU: Steel Type/Advanced Rust Protection Type
 PDUS: Stainless Steel Type

Pin gear

PDU70-G-1B 24T-R

PDU: Type
 70: Frame no. (pitch)
 G: For outer drives / N: For inner drives / S: For linear drives
 1B: No. of teeth (1B: B Type / 1C: C Type)
 P: Advanced Rust Protection Type
 R: Advanced Rust Protection Type
 PDU: Steel Type/Advanced Rust Protection Type
 PDUS: Stainless Steel Type

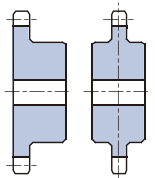

Pin Gear Drive Units

Construction List of available models

Type	Model No.	Size	20	22	30	35	40	50	55	70	80	90	120
Steel Type	PDU		○	○	○	○	○	○	○	○	○	○	○
Advanced Rust Protection Type	PDU-R				○	○	○	○	○	○	○	○	○
Stainless Steel Type	PDUS		○	○	○	○	○	○	○	○	○	○	○

Specifications

Pitch mm	PDU[R] Steel Type (Advanced Rust Protection Type)				PDUS Stainless Steel Type			
	Frame no.	Allowable tangential load		Frame no.	Allowable tangential load			
		kN	{kgf}		kN	{kgf}		
20	PDU20	4.7	{480}	PDUS20	0.8	{80}		
22	PDU22	7.7	{780}	PDUS22	1.1	{110}		
30	PDU30[R]	12.8	{1300}	PDUS30	1.9	{190}		
35	PDU35[R]	19.5	{1990}	PDUS35	2.6	{270}		
40	PDU40[R]	27.3	{2780}	PDUS40	4.1	{420}		
50	PDU50[R]	31.7	{3230}	PDUS50	5.1	{520}		
55	PDU55[R]	52.9	{5390}	PDUS55	7.0	{710}		
70	PDU70[R]	60.7	{6190}	PDUS70	9.9	{1010}		
80	PDU80[R]	71.5	{7290}	PDUS80	12.0	{1220}		
90	PDU90[R]	98.9	{10080}	PDUS90	16.8	{1710}		
120	PDU120[R]	122.5	{12490}	—	—	—		
Allowable Speed	Tangential speed: 50m/min							
Operating Environment	Indoors (no contact with water)			Corrosive environments				
Operating Temperature	-10°C ~ 150°C			-20°C ~ 400°C				
Material	Frame	Rolled steel		Frame	Austenitic stainless steel			
	Bush	Alloy steel		Bush	Precipitation hardened stainless steel			
	Roller	Alloy steel		Roller	Austenitic stainless steel			
	Pin gear	Carbon steel for machine structural use		Pin gear	Austenitic stainless steel			

Backlash (reference)

The above values are in SI units (gravimetric units). Items in { } are reference values. *Pin wheel pitch is circular pitch.

Frame number	PDU[R] Steel Type (Advanced Rust Protection Type) (mm)	PDUS Stainless Steel Type (mm)
PDU(S)20	0.26 ~ 0.47	0.26 ~ 0.47
PDU(S)22	0.32 ~ 0.57	0.32 ~ 0.57
PDU(S)30[R]	0.32 ~ 0.66	0.32 ~ 0.67
PDU(S)35[R]	0.33 ~ 0.88	0.33 ~ 0.88
PDU(S)40[R]	0.41 ~ 0.86	0.41 ~ 0.86
PDU(S)50[R]	0.53 ~ 0.98	0.53 ~ 1.08
PDU(S)55[R]	0.61 ~ 1.06	0.61 ~ 1.26
PDU(S)70[R]	0.86 ~ 1.24	0.86 ~ 1.61
PDU(S)80[R]	0.89 ~ 1.20	0.89 ~ 1.74
PDU(S)90[R]	0.97 ~ 1.42	0.97 ~ 1.92
PDU120[R]	1.30 ~ 1.57	—

*The amount of backlash is a calculated value and not a guaranteed value. Contact a Tsubaki representative regarding low backlash specifications.

Special Specifications Made-to-order models also available.

Material/Surface Treatment	● Black oxide coating ———— Attractive appearance, some rust prevention
	● Electroless Ni-P plating ———— Corrosion and wear resistance
Locking Pin Gear	● All SUS304 ———— Changes the PDUS bush material to SUS304. (Contact a Tsubaki representative for more information.)
	● Pin gear with a frictional lock mechanism ———— Easy phasing (*not available for S Series)
Low Backlash Specifications	Has 2/3 to 1/2 the backlash. (Contact a Tsubaki representative for more information.)

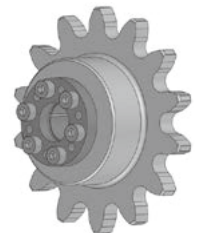

Locking Pin Gear

Pin Gear Drive Units

Usage Examples

Rotating Drives

Turntable



■ Segmented design means it can be made for just the required angle, and is cheaper than a gear set.

Used extensively in work conveyance and in automated equipment

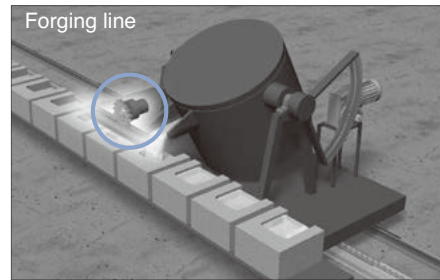

Rotator

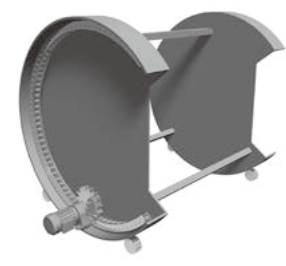

■ No need to adjust tension as with winding chain power transmission.
■ Inner drive allows for compact equipment.

Equipment Maintenance

■ Easy on-site assembly and disassembly
■ Allows for rough installation precision. Setting during assembly is a snap.

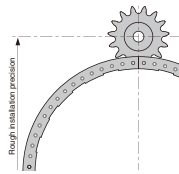

Large diameter swivel tables

Better handleability thanks to segmented delivery

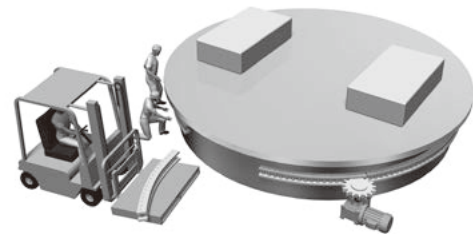

■ Cheaper, lighter, and with a quicker delivery than gears with slewing bearings.
■ No slippage as with roller drives for accurate power transmission

Linear Drives

Carrying truck for heavy loads



■ Extensively used in industrial furnaces

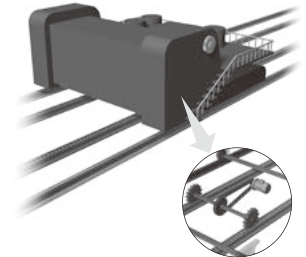
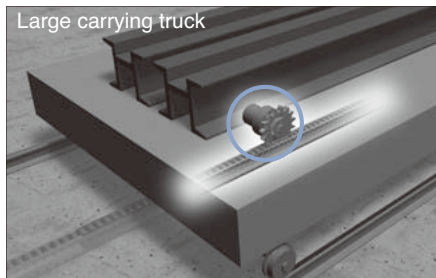

■ Also used to convey heavy loads in steelmaking equipment.

Combination Linear/Curved Drive

Combination of linear and curved drives

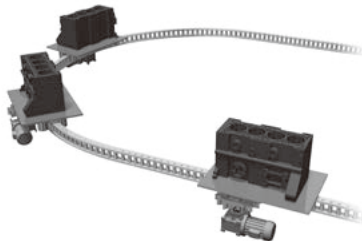

■ Can be used in complex layouts to enable new solutions.

Advanced Rust Protection Type Used Outdoors

Kiln/cooler



■ Cheaper and with quicker delivery than gear sets.
■ Cheaper with a larger velocity ratio than winding chains and sprockets.

Comparison

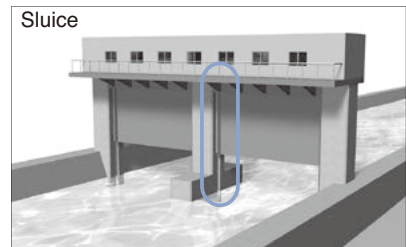
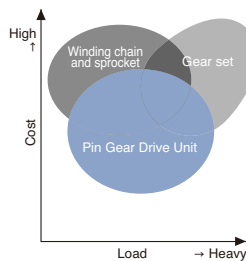

Pin Gear Drive Units

Pin Wheel Models and Specifications

Outer Drive Pin Wheel

(with four sections (ex.))

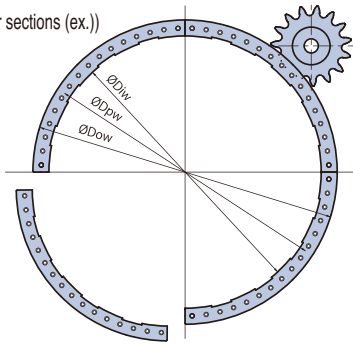

Inner Drive Pin Wheel

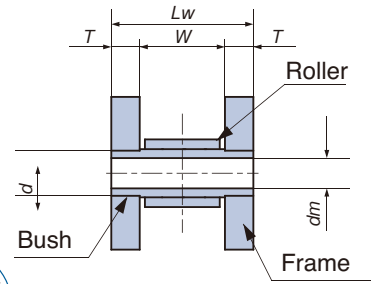
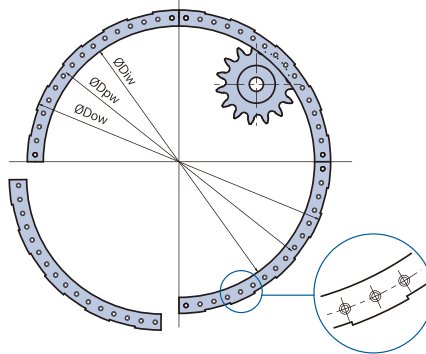

Pin wheel segments
Large pin wheels are segmented for assembly, allowing for large diameter pin wheels to be created by joining segments together.

- *1. There are protrusions on the inner side of each outer drive wheel segment, or on the outer side of each inner drive wheel segment. These form the reference surface for mounting on the partner equipment.
- 2. The inner diameter Diw of the outer drive pin wheel and the outer diameter Dow of the inner drive pin wheel are the outer and inner dimensions of the partner equipment.
- 3. No mounting bolts are provided.
- 4. Pin wheels with numbers of rollers besides those listed available.
- 5. Pin wheels with partial circumferences (less than 360°) available.

Model Numbering Example

PDU70-GW-90P-R

Type
Frame no. (Pitch)
GW: Outer drive NW: Inner drive
No. of rollers
Advanced Rust Protection Type

PDU: Steel Type/Advanced Rust Protection Type
 PDUS: Stainless Steel Type

Pin wheels with partial circumferences (less than 360°) available.

The following is an example of a partial circumference (less than 360°) model number.

PDU70-GW-30/90P

No. of rollers needed
No. of rollers over entire circumference

Pin Wheel Specifications Table (Be aware that no mounting bolts are provided.)

Frame model	PDU20 (Steel Type) PDUS20 (Stainless Steel Type)				PDU22 (Steel Type) PDUS22 (Stainless Steel Type)				PDU30[R] Steel Type (Advanced Rust Protection Type) PDUS30 (Stainless Steel Type)			
	Number of Rollers NT	Number of Segments	Pitch Diameter Dpw	Outer Drive Dow	Inner Drive Diw	Number of Segments	Pitch Diameter Dpw	Outer Drive Dow	Inner Drive Diw	Number of Segments	Pitch Diameter Dpw	Outer Drive Dow
Specifications	Circular pitch <i>P</i>	20		Circular pitch <i>P</i>	22		Circular pitch <i>P</i>	30				
	Roller diameter ϕd	10.16		Roller diameter ϕd	11.91		Roller diameter ϕd	15.88				
	Total width <i>Lw</i>	Standard : 21 S : 22		Total width <i>Lw</i>	Standard : 25 S : 26		Total width <i>Lw</i>	Standard : 31 S : 31				
	Inner width <i>W</i>	12		Inner width <i>W</i>	16		Inner width <i>W</i>	19				
	Frame thickness <i>T</i>	Standard : 4.5 S : 5		Frame thickness <i>T</i>	Standard : 4.5 S : 5		Frame thickness <i>T</i>	Standard : 6 S : 6				
	Mounting hole ϕdm	4.5		Mounting hole ϕdm	4.5		Mounting hole ϕdm	6.4				
	Mounting bolt size	M4		Mounting bolt size	M4		Mounting bolt size	M6				
60	1	381.97	404	359	1	420.17	445	396	1	572.96	605	540
70	1	445.63	468	423	1	490.20	515	466	1	668.45	701	636
80	1	509.30	532	487	1	560.23	585	536	1	763.94	796	731
90	1	572.96	595	550	1	630.25	655	606	3	859.44	892	827
100	1	636.62	659	614	1	700.28	725	676	4	954.93	987	922
110	1	700.28	723	678	1	770.31	795	746	4	1050.42	1083	1018
120	1	763.94	786	741	3	840.34	865	816	5	1145.92	1178	1113
130	3	827.61	850	805	4	910.37	935	886	5	1241.41	1274	1209
140	3	891.27	914	869	4	980.39	1005	956	6	1336.90	1369	1304
150	4	954.93	977	932	4	1050.42	1075	1026	6	1432.39	1465	1400
160	4	1018.59	1041	996	5	1120.45	1145	1096	6	1527.89	1560	1495
170	4	1082.25	1105	1060	5	1190.48	1215	1166	7	1623.38	1656	1591
180	5	1145.92	1168	1123	5	1260.51	1285	1236	7	1718.87	1751	1686
190	5	1209.58	1232	1187	5	1330.54	1355	1306	8	1814.37	1847	1782
200	5	1273.24	1296	1251	6	1400.56	1425	1376	8	1909.86	1942	1877
220	6	1400.56	1423	1378	6	1540.62	1565	1516	9	2100.85	2133	2068
240	6	1527.89	1550	1505	7	1680.68	1705	1656	9	2291.83	2324	2259
260	7	1655.21	1678	1633	8	1820.73	1845	1796	10	2482.82	2515	2450
280	7	1782.54	1805	1760	8	1960.79	1985	1936	11	2673.80	2706	2641
300	8	1909.86	1932	1887	9	2100.85	2125	2076	12	2864.79	2897	2832

Note: 1. Pin wheels with numbers of rollers besides those listed are available.
2. The dimensions shown in this catalog are nominal dimensions and differ from actual dimensions.

Pin Gear Drive Units

Frame model	PDU35[R] Steel Type (Advanced Rust Protection Type) PDU35S (Stainless Steel Type)				PDU40[R] Steel Type (Advanced Rust Protection Type) PDU40S (Stainless Steel Type)				PDU50[R] Steel Type (Advanced Rust Protection Type) PDU50S (Stainless Steel Type)				PDU55[R] Steel Type (Advanced Rust Protection Type) PDU55S (Stainless Steel Type)			
Specifications	Circular pitch P	35			Circular pitch P	40			Circular pitch P	50			Circular pitch P	55		
	Roller diameter ϕd	19.05			Roller diameter ϕd	22.23			Roller diameter ϕd	25.4			Roller diameter ϕd	28.58		
	Total width L_w	Standard : 40 S : 34			Total width L_w	Standard : 46 S : 44			Total width L_w	Standard : 52 S : 46			Total width L_w	Standard : 60 S : 54		
	Inner width W	22			Inner width W	28			Inner width W	28			Inner width W	36		
	Frame thickness T	Standard : 9 S : 6			Frame thickness T	Standard : 9 S : 8			Frame thickness T	Standard : 12 S : 9			Frame thickness T	Standard : 12 S : 9		
	Mounting hole ϕ_{dm}	9			Mounting hole ϕ_{dm}	10.8			Mounting hole ϕ_{dm}	12.8			Mounting hole ϕ_{dm}	12.8		
Mounting bolt size	M8			Mounting bolt size	M10			Mounting bolt size	M12			Mounting bolt size	M12			
Number of Rollers NT	Number of Segments	Pitch Diameter Dpw	Outer Drive Dow	Inner Drive Diw	Number of Segments	Pitch Diameter Dpw	Outer Drive Dow	Inner Drive Diw	Number of Segments	Pitch Diameter Dpw	Outer Drive Dow	Inner Drive Diw	Number of Segments	Pitch Diameter Dpw	Outer Drive Dow	Inner Drive Diw
60	1	668.45	709	628	3	763.94	812	715	3	954.93	1010	899	3	1050.42	1115	986
70	3	779.86	820	739	4	891.27	940	843	4	1114.08	1170	1059	4	1225.49	1290	1161
80	4	891.27	932	851	4	1018.59	1067	970	4	1273.24	1329	1218	5	1400.56	1465	1336
90	4	1002.68	1043	962	5	1145.92	1194	1097	5	1432.39	1488	1377	5	1575.63	1640	1511
100	5	1114.08	1155	1074	5	1273.24	1322	1225	5	1591.55	1647	1536	6	1750.70	1815	1686
110	5	1225.49	1266	1185	6	1400.56	1449	1352	6	1750.70	1806	1695	6	1925.77	1990	1861
120	6	1336.90	1377	1296	6	1527.89	1576	1479	6	1909.86	1965	1854	7	2100.85	2165	2036
130	6	1448.31	1489	1408	7	1655.21	1704	1607	7	2069.01	2125	2014	8	2275.92	2340	2211
140	6	1559.72	1600	1519	7	1782.54	1831	1734	7	2228.17	2284	2173	8	2450.99	2515	2386
150	7	1671.13	1712	1631	8	1909.86	1958	1861	8	2387.32	2443	2332	9	2626.06	2691	2562
160	7	1782.54	1823	1742	8	2037.18	2086	1989	8	2546.48	2602	2491	9	2801.13	2866	2737
170	8	1893.94	1934	1853	9	2164.51	2213	2116	9	2705.63	2761	2650	10	2976.20	3041	2912
180	8	2005.35	2046	1965	10	2291.83	2340	2243	9	2864.79	2920	2809	10	3151.27	3216	3087
190	9	2116.76	2157	2076	10	2419.16	2468	2371	10	3023.94	3079	2968	11	3326.34	3391	3262
200	9	2228.17	2269	2188	11	2546.48	2595	2498	11	3183.10	3239	3128	12	3501.41	3566	3437
220	10	2450.99	2491	2410	12	2801.13	2850	2753	12	3501.41	3557	3446	13	3851.55	3916	3787
240	11	2673.80	2714	2633	13	3055.77	3104	3007	13	3819.72	3875	3764	14	4201.69	4266	4137
260	12	2896.62	2937	2856	14	3310.42	3359	3262	14	4138.03	4194	4083	15	4551.83	4616	4487
280	13	3119.44	3160	3079	15	3565.07	3614	3517	15	4456.34	4512	4401	16	4901.97	4966	4837
300	14	3342.25	3383	3302	16	3819.72	3868	3771	16	4774.65	4830	4719	17	5252.11	5317	5188

Frame model	PDU70[R] Steel Type (Advanced Rust Protection Type) PDU70S (Stainless Steel Type)				PDU80[R] Steel Type (Advanced Rust Protection Type) PDU80S (Stainless Steel Type)				PDU90[R] Steel Type (Advanced Rust Protection Type) PDU90S (Stainless Steel Type)				PDU120[R] Steel Type (Advanced Rust Protection Type)			
Specifications	Circular pitch P	70			Circular pitch P	80			Circular pitch P	90			Circular pitch P	120		
	Roller diameter ϕd	35.71			Roller diameter ϕd	39.68			Roller diameter ϕd	47.63			Roller diameter ϕd	63.5		
	Total width L_w	Standard : 72 S : 60			Total width L_w	Standard : 74 S : 66			Total width L_w	Standard : 90 S : 76			Total width L_w	Standard : 112		
	Inner width W	40			Inner width W	42			Inner width W	52			Inner width W	68		
	Frame thickness T	Standard : 16 S : 10			Frame thickness T	Standard : 16 S : 12			Frame thickness T	Standard : 19 S : 12			Frame thickness T	Standard : 22		
	Mounting hole ϕ_{dm}	17			Mounting hole ϕ_{dm}	17			Mounting hole ϕ_{dm}	22			Mounting hole ϕ_{dm}	32		
Mounting bolt size	M16			Mounting bolt size	M16			Mounting bolt size	M20			Mounting bolt size	M30			
Number of Rollers NT	Number of Segments	Pitch Diameter Dpw	Outer Drive Dow	Inner Drive Diw	Number of Segments	Pitch Diameter Dpw	Outer Drive Dow	Inner Drive Diw	Number of Segments	Pitch Diameter Dpw	Outer Drive Dow	Inner Drive Diw	Number of Segments	Pitch Diameter Dpw	Outer Drive Dow	Inner Drive Diw
60	4	1336.90	1409	1264	5	1527.89	1608	1447	6	1718.87	1815	1622	8	2291.83	2442	2141
70	5	1559.72	1632	1487	6	1782.54	1863	1702	7	2005.35	2102	1909	9	2673.80	2824	2523
80	6	1782.54	1855	1710	7	2037.18	2118	1957	8	2291.83	2388	2195	10	3055.77	3206	2905
90	7	2005.35	2078	1933	8	2291.83	2372	2211	9	2578.31	2675	2482	12	3437.75	3588	3287
100	7	2228.17	2301	2156	9	2546.48	2627	2466	10	2864.79	2961	2768	13	3819.72	3970	3669
110	8	2450.99	2523	2378	9	2801.13	2882	2721	11	3151.27	3248	3055	14	4201.69	4352	4051
120	9	2673.80	2746	2601	10	3055.77	3136	2975	12	3437.75	3534	3341	15	4583.66	4734	4433
130	10	2896.62	2969	2824	11	3310.42	3391	3230	12	3724.23	3821	3628	16	4965.63	5116	4815
140	10	3119.44	3192	3047	12	3565.07	3646	3485	13	4010.70	4107	3914	18	5347.61	5498	5197
150	11	3342.25	3415	3270	13	3819.72	3900	3739	14	4297.18	4394	4201	19	5729.58	5880	5579
160	12	3565.07	3638	3493	13	4074.37	4155	3994	15	4583.66	4680	4487	20	6111.55	6262	5961
170	12	3787.89	3860	3715	14	4329.01	4410	4249	16	4870.14	4967	4774	21	6493.52	6644	6343
180	13	4010.70	4083	3938	15	4583.66	4664	4503	17	5156.62	5253	5060	22	6875.49	7026	6725
190	14	4233.52	4306	4161	16	4838.31	4919	4758	18	5443.10	5540	5347	24	7257.47	7408	7107
200	15	4456.34	4529	4384	17	5092.96	5173	5012	19	5729.58	5826	5633	25	7639.44	7790	7489
220	16	4901.97	4974	4829	18	5602.25	5683	5522	21	6302.54	6399	6206	27	8403.38	8554	8253
240	17	5347.61	5420	5275	20	6111.55	6192	6031	22	6875.49	6972	6779	30	9167.32	9318	9017
260	19	5793.24	5866	5721	21	6620.85	6701	6540	24	7448.45	7545	7352	32	9931.27	10082	9781
280	20	6238.87	6311	6166	23	7130.14	7211	7050	26	8021.41	8118	7925	35	10695.21	10846	10545
300	22	6684.51	6757	6612	25	7639.44	7720	7559	28	8594.37	8691	8498	37	11459.16	11610	11309

Note: 1. Pin wheels with numbers of rollers besides those listed are available.

2. The dimensions shown in this catalog are nominal dimensions and differ from actual dimensions.

Pin Gear Drive Units

Pin Rack Models and Specifications

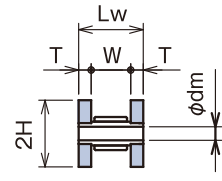
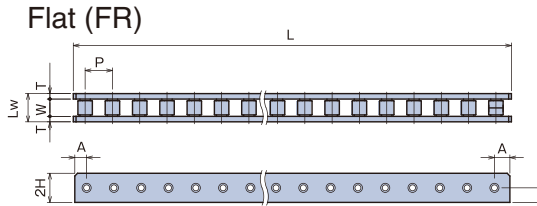
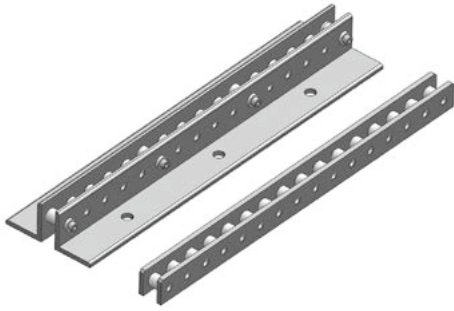

*The hollow pins in angled models need to be fixed to the rack by bolts and nuts.

Angled (AR)

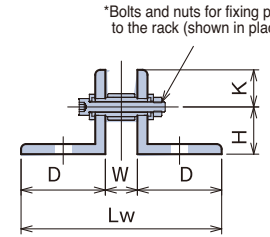
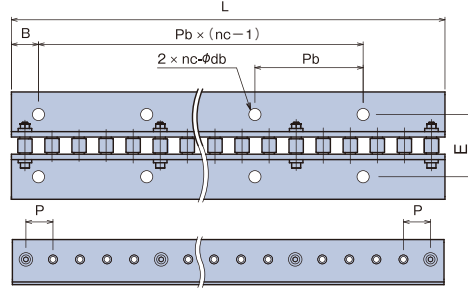

*Bolts and nuts for fixing pins to the rack (shown in place).

Model Numbering Example

PDU55-FR-18P-R

PDU: Steel Type/Advanced Rust Protection Type
PDU5: Stainless Steel Type
55: Frame no. (Pitch)
FR: Flat
AR: Angled
18: No. of rollers
P: Advanced Rust Protection Type
R: Type

Flat Type Specifications Table [R] Advanced Rust Protection Type

Specifications	Frame model	Pitch P	Set Length		Frame Thickness T	Pin Position A	Inner Width W	Total Width Lw	Total Height 2H	Bolt Bore Dia. φdm	Mounting Bolt Size	Mass kg	Minimum Available Length	
			Total length L	No. of rollers NT									Total length L	No. of rollers NT
Steel Type	PDU20	20	800	40	4.5	10	12	21	22	4.5	M4	1.5	160	8
	PDU22	22	792	36	4.5	11	16	25	25	4.5	M4	1.8	286	13
	PDU30[R]	30	780	26	6	15	19	31	32	6.5	M6	3.0	300	10
	PDU35[R]	35	770	22	9	17.5	22	40	38	9	M8	5.0	280	8
	PDU40[R]	40	800	20	9	20	28	46	45	10.8	M10	6.4	280	7
	PDU50[R]	50	1000	20	12	25	28	52	65	12.8	M12	14.0	300	6
	PDU55[R]	55	990	18	12	27.5	36	60	65	12.8	M12	14.9	495	9
	PDU70[R]	70	980	14	16	35	40	72	75	17	M16	22.2	420	6
	PDU80[R]	80	960	12	16	40	42	74	90	17	M16	26.3	560	7
PDU90[R]	90	990	11	19	45	52	90	100	22	M20	36.5	540	6	
PDU120[R]	120	960	8	22	60	68	112	150	32	M30	60.7	480	4	
Stainless Steel Type	PDU520	20	800	40	5	10	12	22	22	4.5	M4	1.6	160	8
	PDU522	22	792	36	5	11	16	26	25	4.5	M4	2.0	286	13
	PDU530	30	780	26	6	15	19	31	32	6.5	M6	3.1	300	10
	PDU535	35	770	22	6	17.5	22	34	38	9	M8	3.7	280	8
	PDU540	40	800	20	8	20	28	44	50	10.8	M10	6.5	280	7
	PDU550	50	1000	20	9	25	28	46	65	12.8	M12	11.1	300	6
	PDU555	55	990	18	9	27.5	36	54	65	12.8	M12	12.1	495	9
	PDU570	70	980	14	10	35	40	60	75	17	M16	15.6	420	6
	PDU580	80	960	12	12	40	42	66	90	17	M16	21.3	560	7
PDU590	90	990	11	12	45	52	76	100	22	M20	26.2	540	6	

*Racks with numbers of rollers besides those listed are available.

Angled Type Specifications [R] Advanced Rust Protection Type

Specifications	Frame model	Pitch P	Set Length		Inner Width W	Total Width Lw	Angled Leg Width D	Center Height		Mounting Hole Position						Mounting Bolt Size	Mass kg	Minimum Available Length	
			Total length L	No. of rollers NT				H	K	Width E	End width B	Pitch Pb	Mounting hole spacing Pb X nc	No. of holes (one side) nc	Bore dia. φdb			Total length L	No. of rollers NT
Steel Type	PDU20	20	800	40	12	72	30	20	10	56	20	120	720	7	9	M8	2.4	160	8
	PDU22	22	792	36	16	96	40	27	13	60	22	88	704	9	11	M10	3.3	132	6
	PDU30[R]	30	780	26	19	119	50	28	22	69	30	120	720	7	13.5	M12	5.9	180	6
	PDU35[R]	35	770	22	22	122	50	30	20	76	35	140	700	6	13.5	M12	7.7	210	6
	PDU40[R]	40	800	20	28	128	50	28	22	88	40	120	720	7	13.5	M12	8.5	320	8
	PDU50[R]	50	1000	20	28	158	65	40	25	104	50	150	900	7	17.5	M16	17.1	250	5
	PDU55[R]	55	990	18	36	166	65	37	28	112	55	165	825	6	17.5	M16	18.0	440	8
	PDU70[R]	70	980	14														560	8
	PDU80[R]	80	960	12														480	6
PDU90[R]	90	990	11														540	6	
PDU120[R]	120	960	8														480	4	
Contact a Tsubaki representative for details.																			
Stainless Steel Type	PDU520	20	800	40	12	72	30	20	10	56	20	120	720	7	9	M8	2.4	160	8
	PDU522	22	792	36	16	96	40	27	13	60	22	88	704	9	11	M10	3.4	132	6
	PDU530	30	780	26	19	119	50	28	22	69	30	120	720	7	13.5	M12	6.6	180	6
	PDU535	35	770	22	22	122	50	30	20	76	35	140	700	6	13.5	M12	6.8	210	6
	PDU540	40	800	20	28	128	50	28	22	88	40	120	720	7	13.5	M12	7.5	320	8
	PDU550	50	1000	20	28	158	65	40	25	104	50	150	900	7	17.5	M16	13.8	250	5
PDU555	55	990	18	36	166	65	37	28	112	55	165	825	6	17.5	M16	14.8	440	8	

Note:

1. Long length pin racks are constructed as either "set length x no. of rollers" or "set length x no. of rollers + no. of rollers less than set length." Contact a Tsubaki representative regarding special numbers of rollers.
2. No mounting bolts are provided.
3. The dimensions shown in this catalog are nominal dimensions and differ from actual dimensions.

Pin Gear Drive Units

Pin Gear Models and Specifications

Model Numbering Example

PDU90-S-1B 24T-R

PDU: Steel Type/Advanced Rust Protection Type
90: Pitch (Pitch)
S: Linear type
1B: B Type
24T: No. of teeth
R: Advanced Rust Protection Type

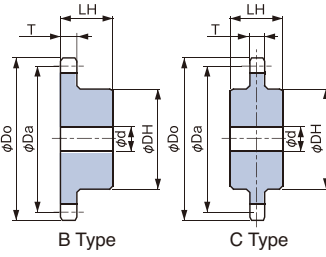

	Standard Series	S Series
Material	Machine structural use carbon steel	Stainless steel
Configuration	B and C types	
Tooth hardening	Induction hardened and tempered	None

*Other materials available.
 *Shaft bore finishing available.
 *Lock pin gear specifications (with a frictional locking mechanism) available. (See the diagram below.)

Pin Gear Applicable Number of Teeth Range (for both Standard and S Series)

No. of Teeth NT	Linear Rack	Outer Drive Pin Wheel Number of Rollers								Inner Drive Pin Wheel Number of Rollers							
		60	70	80	100	150	200	250	300	60	70	80	100	150	200	250	
11	×	×	×	×	×	×	×	×	×	○	○	○	○	×	×	×	
12	△	×	×	×	×	×	×	×	×	○	○	○	○	×	×	×	
13	○	×	×	△	△	△	△	△	△	○	○	○	○	○	○	○	
14	○	×	×	△	△	△	△	△	△	○	○	○	○	○	○	○	
15	○	△	△	△	△	△	△	△	△	○	○	○	○	○	○	○	
16	○	△	△	△	△	△	△	△	△	○	○	○	○	○	○	○	
17	○	△	△	△	△	△	△	△	△	○	○	○	○	○	○	○	
18	○	△	△	△	△	△	△	△	△	○	○	○	○	○	○	○	
19	○	△	△	△	△	○	○	○	○	○	○	○	○	○	○	○	
20	○	△	△	△	○	○	○	○	○	○	○	○	○	○	○	○	
21	○	△	△	○	○	○	○	○	○	○	○	○	○	○	○	○	
22	○	△	○	○	○	○	○	○	○	○	○	○	○	○	○	○	
23	○	△	○	○	○	○	○	○	○	○	○	○	○	○	○	○	
24 and more	○	○	○	○	○	○	○	○	○	○	○	○	○	○	○	○	

○ : Permissible
 △ : Tangential load may decrease depending on usage conditions. Contact a Tsubaki representative for more information.
 × : Not allowed (due to an insufficient engagement factor)

Pin Gear Specifications Chart (for both Standard and S Series)

[R] Advanced Rust Protection Type (S) Stainless Steel Type

Frame No.	PDU (S) 20					PDU (S) 22					PDU (S) 30					PDU (S) 35 [R]				
	Pitch P					Pitch P					Pitch P					Pitch P				
	Roller dia. (ref.)		10.16			Roller dia. (ref.)		11.91			Roller dia. (ref.)		15.88			Roller dia. (ref.)		19.05		
	Tooth width T		9			Tooth width T		12			Tooth width T		15			Tooth width T		18		
No. of Teeth NT	Pitch Dia. Da	Outer Dia. Do	Pilot Bore Dia. d	Hub Dia. DH	Hub Length LH	Pitch Dia. Da	Outer Dia. Do	Pilot Bore Dia. d	Hub Dia. DH	Hub Length LH	Pitch Dia. Da	Outer Dia. Do	Pilot Bore Dia. d	Hub Dia. DH	Hub Length LH	Pitch Dia. Da	Outer Dia. Do	Pilot Bore Dia. d	Hub Dia. DH	Hub Length LH
11	72.43	85	12.7	43	20	80.03	95	12.7	45	30	108.44	129	15.9	65	50	126.55	151	23	75	80
12	78.59	91	12.7	49	20	86.83	102	12.7	50	40	117.79	138	19.0	75	50	137.49	162	23	85	80
14	91.13	105	12.7	50	30	100.44	115	15.9	60	40	136.49	157	19.0	80	50	159.57	184	23	110	90
16	103.66	116	12.7	50	30	114.05	129	15.9	70	40	155.39	176	19.0	80	60	181.65	206	28	120	100
18	116.19	129	12.7	60	30	127.85	143	15.9	70	50	174.29	194	19.0	90	60	203.74	228	28	120	100
20	128.72	141	12.7	60	30	141.66	157	15.9	70	50	192.99	213	23.0	90	70	225.82	250	28	130	100
22	141.46	154	15.9	60	40	155.66	171	15.9	70	50	212.08	232	23.0	90	70	247.90	272	33	130	110
24	153.99	167	15.9	60	40	169.47	184	18.0	70	50	230.98	251	23.0	100	70	269.58	294	33	130	110

Frame No.	PDU (S) 40 [R]					PDU (S) 50 [R]					PDU (S) 55 [R]					PDU (S) 70 [R]				
	Pitch P					Pitch P					Pitch P					Pitch P				
	Roller dia. (ref.)		22.23			Roller dia. (ref.)		25.4			Roller dia. (ref.)		28.58			Roller dia. (ref.)		35.71		
	Tooth width T		24			Tooth width T		24			Tooth width T		30			Tooth width T		34		
No. of Teeth NT	Pitch Dia. Da	Outer Dia. Do	Pilot Bore Dia. d	Hub Dia. DH	Hub Length LH	Pitch Dia. Da	Outer Dia. Do	Pilot Bore Dia. d	Hub Dia. DH	Hub Length LH	Pitch Dia. Da	Outer Dia. Do	Pilot Bore Dia. d	Hub Dia. DH	Hub Length LH	Pitch Dia. Da	Outer Dia. Do	Pilot Bore Dia. d	Hub Dia. DH	Hub Length LH
11	145.66	174	28	90	80	181.47	214	33	100	90	200.18	237	33	120	140	252.30	298	43	157	150
12	157.79	186	28	100	90	196.59	229	33	110	100	216.08	253	33	135	140	273.98	320	43	170	160
14	182.65	211	28	120	100	227.62	260	33	130	110	250.30	287	33	160	140	317.94	364	43	180	160
16	207.72	236	33	120	100	259.05	292	33	140	120	284.91	322	33	170	150	362.11	408	43	190	160
18	232.58	261	33	130	100	290.48	323	33	140	130	319.53	356	33	170	160	406.07	452	43	190	170
20	257.85	286	33	130	110	321.91	354	33	150	140	354.14	391	33	180	160	450.43	496	43	200	190
22	283.31	312	33	140	120	353.74	386	33	150	140	389.15	426	38	180	160	495.00	541	63	210	190
24	308.18	337	33	140	120	384.97	417	33	160	140	423.57	460	38	190	170	538.76	585	63	210	190

Frame No.	PDU (S) 80 [R]					PDU (S) 90 [R]					PDU 120 [R]				
	Pitch P					Pitch P					Pitch P				
	Roller dia. (ref.)		39.68			Roller dia. (ref.)		47.63			Roller dia. (ref.)		63.5		
	Tooth width T		36			Tooth width T		45			Tooth width T		60		
No. of Teeth NT	Pitch Dia. Da	Outer Dia. Do	Pilot Bore Dia. d	Hub Dia. DH	Hub Length LH	Pitch Dia. Da	Outer Dia. Do	Pilot Bore Dia. d	Hub Dia. DH	Hub Length LH	Pitch Dia. Da	Outer Dia. Do	Pilot Bore Dia. d	Hub Dia. DH	Hub Length LH
11	288.11	339	43	180	150	325.13	387	43	210	180	435.17	517	63	250	240
12	312.78	364	43	190	160	352.77	414	43	220	190	472.37	554	63	260	240
14	363.11	414	43	200	180	409.07	470	43	230	210	546.76	629	63	270	250
16	413.64	465	43	210	200	465.97	527	63	240	230	621.15	703	63	280	260
18	463.97	515	43	220	200	522.66	584	63	250	250	696.95	779	63	290	280
20	514.50	566	63	230	200	579.56	641	63	260	250	772.54	855	68	300	300
22	565.43	617	63	230	210	636.85	698	63	270	260	848.94	931	68	310	320
24	615.55	667	63	240	230	692.95	754	63	270	260	923.73	1006	68	320	320

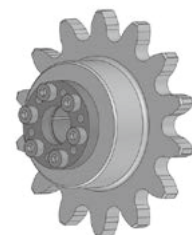

Locking Pin Gear (keyless friction type integrated coupling locking pin gear)

Note: 1. The tooth profile of pin gears will vary depending on the application (outer drive, inner drive, or linear).
 2. The dimensions shown in this catalog are nominal dimensions and differ from actual dimensions.

Before Use
 Standard Roller Chains
 Lite-Free Roller Chains
 Heavy Duty Roller Chains
 Corrosion Resistant Roller Chains
 Specialty Roller Chains
 Sprockets
 Pin Gear Drives
 Accessories
 Selection
 Handling

Pin Gear Drive Unit Selection and Installation

Selection Guide

1. Provisionally select pin gear drive unit pitch diameter

- For rotating movement : Provisionally select the pitch diameter of the pin wheel from the size of the rotating equipment.
Provisionally select the pitch diameter of the pin gear from the reduction ratio.
- For linear movement : Provisionally select the pitch diameter of the pin gear from the equipment layout.

2. Calculate tangential load F_w of the load

Calculate tangential load F_w of the load acting on the pin wheel or pin rack from the load conditions.

3. Calculate corrected tangential load F_t

Find the usage factor K_s (Table 1) from the operating conditions and the speed factor K_v (Table 2) from the tangential speed and determine the corrected tangential load F_t by multiplying the above with the tangential load F_w of the load.

$$F_t = K_s \times K_v \times F_w$$

4. Select the pin gear drive unit frame model

Select a pin gear drive unit frame model that satisfies the conditions below from the allowable tangential load F_p and the corrected tangential load F_t of each pin rack or pin wheel frame model.

Allowable tangential load $F_p >$ Corrected tangential load F_t

5. Select the model number

- Pin wheel : Select the number of rollers of the pin wheel with a pitch diameter closest to the pitch diameter of the pin wheel provisionally selected and the selected frame model.
- Pin rack : Find the number of rack rollers from the selected frame model and the running distance (or the stroke distance).
- Pin gear : Select the number of teeth of the pin gears with a pitch diameter closest to the pitch diameter of the pin gear provisionally selected and the selected frame model.

Note: There are limits to the range of the number of pin gear teeth usable.
(See the table on pg. 154.) Reselect the number of teeth if insufficient.

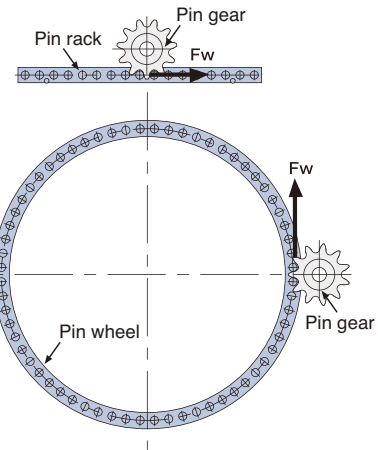

Table 1: Usage factor K_s

Operating Conditions	Running Time (hrs/day)		
	Less than 3	Less than 12	Less than 24
Even load	1.00 (1.25)	1.15 (1.40)	1.25 (1.50)
Load with some impact	1.25 (1.50)	1.40 (1.70)	1.60 (2.00)
Load with major impact	1.50 (1.80)	1.75 (2.15)	2.00 (2.50)

Use the values in parentheses when the Pin Gear Drive unit will be started and stopped over ten times an hour.

Table 2 Speed factor K_v

Tangential Speed [m/min]	Less than 10	11-14	15-19	20-24	25-29	30-34	35-39	40-49	50
Speed factor	1.02	1.04	1.05	1.06	1.06	1.07	1.08	1.1	1.2

Installation Precision

Flat/Wheel

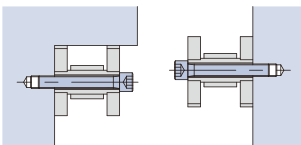

Uses a hollow pin. Use the pin hole to bolt the outer surface to the adjoining equipment.
A stopper or guide can be installed on the surface of the protruding area to allow for positioning when installing.

Angled

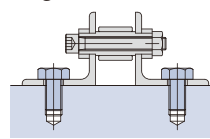

Angled linear racks have a hole for fastening bolts. Use them to bolt the feet to the adjoining equipment.

Mounting bolt position

Bolts are distributed evenly on both ends of the segment, and at points in between. Mount the segment using more than the minimum number of bolts. (See table below.)

Wheel/Flat Types

Minimum number of mounting bolts per segment

Type	Frame No.	Mounting Bolt Size	Min. Number of Bolts	Type	Frame No.	Mounting Bolt Size	Min. Number of Bolts
Steel/Advanced Rust Protection Type	PDU20	M4	8	Stainless Steel Type	PDU20	M4	8
	PDU22	M4	13		PDU22	M4	13
	PDU30	M6	10		PDU30	M6	10
	PDU35	M8	8		PDU35	M8	8
	PDU40	M10	7		PDU40	M10	7
	PDU50	M12	6		PDU50	M12	6
	PDU55	M12	9		PDU55	M12	9
	PDU70	M16	6		PDU70	M16	6
	PDU80	M16	7		PDU80	M16	7
	PDU90	M20	6		PDU90	M20	6
PDU120	M30	4	PDU120	M30	4		

(Ex.) Mounting position: PDU55-GW-64P with 4 segments
See the diagram below (Black circles indicate mounting position)

PDU55 has a minimum of nine mounting bolts (M12)
Use more than nine bolts spaced as evenly as possible when mounting each segment.

*Contact a Tsubaki representative with any questions regarding mounting that you may have.

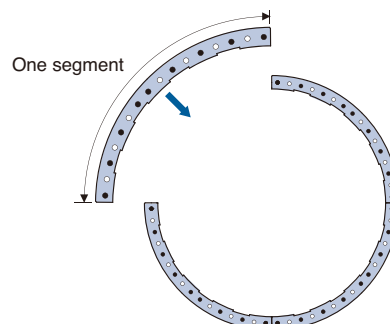

Mounting bolts : Use the following hexagonal bolts

PDU[R] Steel/Advanced Rust Protection Types : Strength class 12.9
PDUS Stainless Steel Type : Strength class 50

Pin Gear Drive Unit Selection and Installation

Installation Precision

Pin wheel : The protruding surface of the pin wheel frame has been machined to be concentric with the roller mounting holes. The frame acts as a centering reference plane, allowing it to be mounted by press fitting it into the centering section of the equipment. The precision of the equipment's centering section should be finished as per the Centering Section Precision table below.

Pin rack : Calculate the parallelism between equipment beforehand so that the parallelism between the installation reference plane on the pin rack side and the pin gear center fall within the Gear Center Parallelism table below. Install the pin rack so that the positions of A and B on both connecting elements fall within the table below.

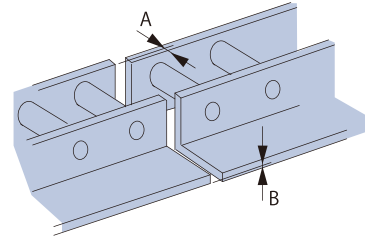
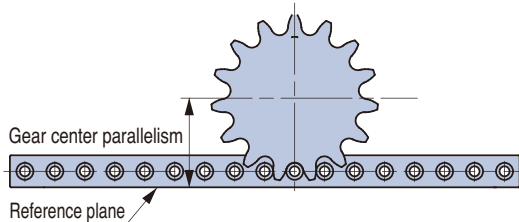
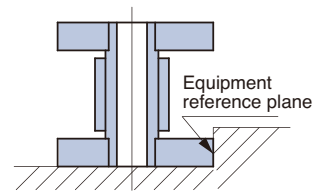

*Read all appropriate instructions before mounting.

Frame Model		PDU20 PDUS20	PDU22 PDUS22	PDU30 PDUS30	PDU35 PDUS35	PDU40 PDUS40	PDU50 PDUS50	PDU55 PDUS55	PDU70 PDUS70	PDU80 PDUS80	PDU90 PDUS90	PDU120
Rotating Drive	Centering section precision (mm)	0.3	0.3	0.4	0.5	0.6	0.7	0.8	0.9	1.0	1.2	1.6
	Linear Drive											
Linear Drive	Gear center parallelism (mm)	0.3	0.3	0.4	0.5	0.6	0.7	0.8	0.9	1.0	1.2	1.6
	Connecting element positioning A·B (mm)	0.1	0.2	0.2	0.3	0.3	0.4	0.4	0.5	0.5	0.6	0.8

Lubrication

Coat all roller outer surfaces with an extreme pressure grease before operation. The pin wheel and inner surfaces of the pin rack rollers have already been greased. Contact a Tsubaki representative if you are using the unit in an environment where you cannot grease, such as underwater, or in 130°C temperatures or above.

Corrosion resistance guide for PDUS Stainless Steel Type

Corrosion resistance varies accordingly depending on application conditions. This table should not be considered as a guarantee. Using this chart as a reference, be sure to check the corrosion resistance of the chain in advance according to the actual operating conditions determining chain type.

○ : Sufficient corrosion resistance △ : Corrosion resistance in some applications × : No corrosion resistance - : Unknown

Chemical / Food product	Resistance
Acetic acid 10% 20°C	○
Acetone 20°C	○
Alcohol (Methyl, ethyl, propyl, and butyl)	○
Aluminum sulfate Saturated 20°C	×
Ammonia water 20°C	○
Ammonium chloride 50% Boiling point	×
Ammonium nitrate Saturated boiling	○
Ammonium sulfate " 20°C	△
Beer 20°C	○
Benzene 20°C	○
Boric acid 50% 100°C	○
Butyric acid 20°C	○
Calcium chloride " 20°C	×
Calcium hypochlorite (Bleaching powder) Available chlorine 11~14% 20°C	×
Carbolic acid 20°C	○
Carbon tetrachloride (Dry) 20°C	○
Carbonated water	○
Chlorine gas (Dry) 20°C	×
Chlorine gas (Wet) 20°C	×
Chlorine water	×
Chromic acid 5% 20°C	△
Citric acid 50% 20°C	○
Coffee Boiling	○
Cola syrup	○
Concentrated nitric acid 65% 20°C	×
" " Boiled	×
Creosote 20°C	○
Developing solution (Photo) 20°C	△
Ether (Ethyl ether) 20°C	○
Ferric chloride 5% 20°C	×
Formalin (Formaldehyde) 40% 20°C	○

Chemical / Food product	Resistance
Formic acid 50% 20°C	○
Fruit juice 20°C	△
Gasoline 20°C	○
Glycerine 20°C	○
Honey, syrup	○
Hydrochloric acid 2% 20°C	×
Hydrogen peroxide 30% 20°C	△
Hydrogen sulfide (Dry)	○
" (Moistened)	×
Kerosene 20°C	○
Ketchup 20°C	○
Lactic acid 10% 20°C	△
Lard	○
Linseed oil 100% 20°C	△
Malic acid 50% 50°C	○
Mayonnaise 20°C	△
Milk 20°C	○
Nitric acid 5% 20°C	△
Oil (Plant and mineral) 20°C	○
Oleic acid 20°C	○
Oxalic acid 10% 20°C	△
Paraffin 20°C	○
Petroleum 20°C	○
Phosphoric acid 5% 20°C	△
" 10% 20°C	△
Picric acid Saturated 20°C	○
Potassium chloride Saturated 20°C	△
Potassium dichromate 10% 20°C	○
Potassium hydroxide (caustic potash) 20% 20°C	○
Potassium hydroxide (slaked lime) Boiling point	○
Potassium nitrate 25% 20°C	○

Chemical / Food product	Resistance
Potassium nitrate 25% Boiling point	×
Seawater 20°C	×
Soapy water 20°C	○
Sodium carbonate Saturated boiling point	○
Sodium chloride " 20°C	△
Sodium cyanide 20°C	-
Sodium bicarbonate 20°C	○
Sodium hydroxide (caustic potash) 25% 20°C	○
Sodium hypochlorite 10% 20°C	×
Sodium perchlorate 10% Boiling point	×
Sodium permanganate (saturated) 20°C	○
Sodium sulfate Saturated 20°C	○
Sodium thiosulfate 25% Boiling point	○
Soft drink 20°C	○
Stearic acid 100% Boiling point	×
Sugar solution 20°C	○
Sulfur dioxide (Wet) 20°C	×
Sulfuric acid 5% 20°C	×
Synthetic detergent	○
Tartaric acid 10% 20°C	○
Turpentine oil 35°C	○
Varnish	○
Vegetable juice 20°C	○
Vinegar 20°C	×
Water	○
Whiskey 20°C	○
Wine 20°C	○
Zinc chloride 50% 20°C	×
Zinc sulfate 25% Saturated 20°C	○

Sprocket & Shaft Sets

We manufacture the sprocket together with the shaft and deliver as a set. There is no need for the customer to assemble them together, leading to higher cost performance.

Features

- No need to assemble the shaft into the sprocket.
- No need to inspect the shaft upon receipt.
We can also provide an inspection report with the inspection results. (Separate fee required.)
- Can be attached as-is to your equipment after receipt.
(Bearings and the like can also be included in the assembly upon request.)
- Sprocket and shaft are sourced from the same supplier, which can reduce time needed for oversight compared to ordering from separate suppliers.

Comparison of time needed to install in equipment



There is no need to assemble the shaft into the sprocket, saving 30-35% in mounting time.

Specifications

- Shaft Assembled Type : Shaft and sprocket are manufactured together and delivered assembled.
- Integrated Type : Shaft is machined as part of the sprocket

Shaft Assembled Type

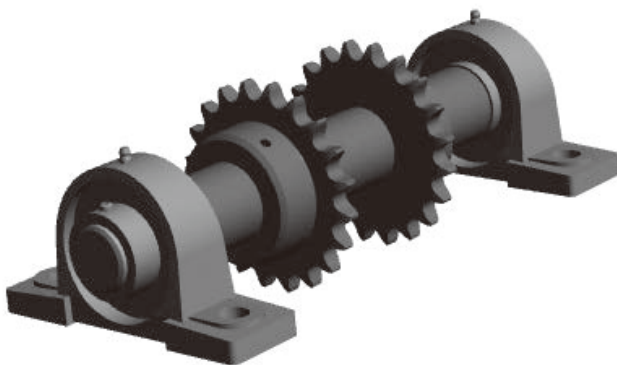

Shaft Integrated Type

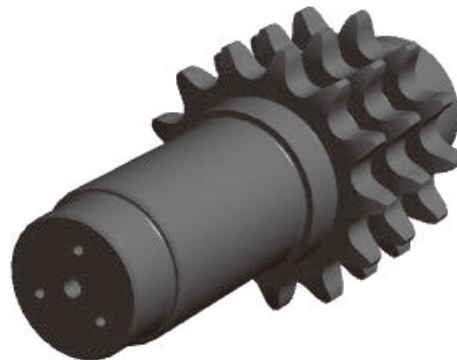

- Available for Lock Sprockets as well.
- Phasing and other assembly conditions available.

Indicate the following on your request for quotation

- Sprocket specifications
- Phasing or other assembly instructions
- Shaft drawing or other material that indicates dimensions
- Parts included in assembly (shaft, keys, bearings, etc.) (Contact a Tsubaki representative regarding bearings.)
- Coatings, plating, etc.
- Documents needed from Tsubaki: Delivery drawings, inspection results, etc.

Accessories (Peripheral Instruments)

Chain Tensioners

The Tsubaki Chain Tensioner adjusts slackness in the chain to enable continuous and proper chain operation.

page 159

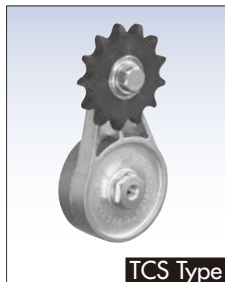

TCS Type

FR Idler Sprockets

Bearing with hub that reliably transmits rotation.

page 163



FR Idler Sprocket

Chain Cutting Tools

These tools enable chains to be cut to the desired length.

page 165



Chain Vise



Punch

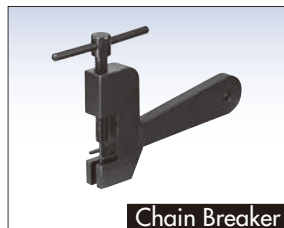

Chain Breaker

Chain Connecting Tools

This tool pulls the two ends of the chain together when installing the chain on a machine.

page 166

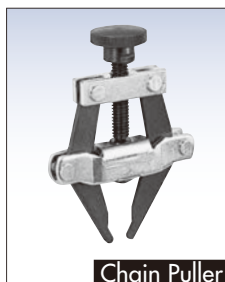

Chain Puller

End Fixtures

The end fitting bolts and end fitting bolt connecting links are designed to be stronger than those of RS Roller Chains.

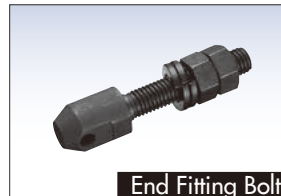

End Fitting Bolt



End Fitting Bolt Connecting Link

page 167

Automatic Lubricators for Roller Chain

1. Operational period can be freely set
2. Reduces maintenance time
3. Lightweight, compact
4. Can be installed in any direction
5. Waterproof
6. Includes an inspection window
7. Highly safe
8. Reliable



Automatic Lubricator for Roller Chain

page 168

Chain Elongation Scales

Allows quick checks of pitch elongation limit.



Chain Elongation Scale

page 170

Chain Tensioners

Slackness in the chain can cause chain vibration and noise, and improper engagement with the sprocket, as well as preventing the chain from operating properly. The Tsubaki Chain Tensioner adjusts slackness in the chain to enable continuous and proper chain operation.

There are four types of Tsubaki Chain Tensioners: Our new TH Type (straight type, with idler sprocket), the TCS Type (swing type, with idler sprocket), the ETS Type (straight type, with idler sprocket), and the TA Type (straight type, with plastic shoe).

Construction

Main unit

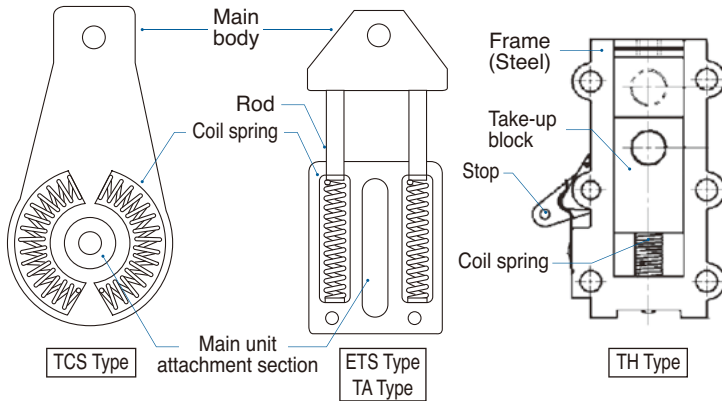

The Tsubaki Chain Tensioner is composed of a main unit and an idler sprocket. (The TA Type is a unitized construction with plastic shoe.) The tensioner's main unit employs the elasticity of a built-in coil spring to tension.

TA Type main unit attachment bolt Table 1

Model Number	Main Unit Attachment Bolt	Model Number	Main Unit Attachment Bolt
CT-TA40	M10	CT-TA60	M12
CT-TA50	M12	CT-TA80	M14

Note: Tensioner attachment bolt not included with tensioner.

Idler sprocket

The idler sprocket is composed of a sprocket with a built-in bearing, (TH Type provided with a lube-free bush upon request) an attachment bolt, and a washer. The sprocket teeth undergo induction hardening. TCS and ETS Types are given a black coating, while TH Type is plated.

TCS/ETS Types Table 2

Model Number	Sprocket No. of Teeth	Sprocket Mounting Bolt				Flat Washer		Tensioner Mounting Bolt
		Size	Length	Strength Classification	Quantity	Nominal	Quantity	
CT-TCS40	17	M10	30	10.9	1	10	2	M10
CT-ETS40			35					
CT-TCS50	15	M10	30	10.9	1	10	2	M10
CT-ETS50			35					
CT-TCS60	13	M12	35	10.9	1	12	2	M12
CT-ETS60			45					
CT-TCS80	11	M12	35	10.9	1	12	4	M12
CT-ETS80			45					

TH Type Table 3

Model Number	Applicable Size	Sprocket No. of Teeth	Sprocket Mounting Bolt	
			Size	Length
CT-TH1	RS35-1	20	M12	45
	RS40-1	15		
CT-TH2	RS50-1	15	M12	55
	RS60-1	14		
	RS80-1	11		

TCS and ETS Type Assembly

Remove the main unit of the TCS or ETS Type tensioner, the idler sprocket, attachment bolt and washers from their packaging, and assemble them as shown in Fig. 1. The plastic shoe for the TA type comes as part of the main unit and no assembly is required. One flat washer should be installed on each side of the idler sprocket. However, the CT-TCS80 and CT-ETS80 should have two washers installed on each side. The idler sprocket attachment bolt and flat washers are included with the idler sprocket.

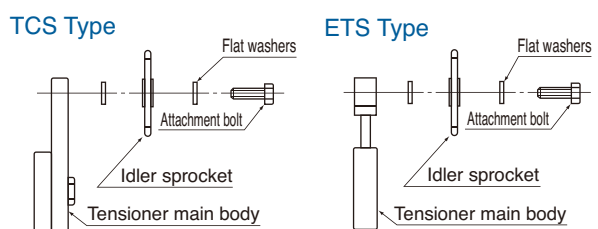

Fig. 1 Chain tensioner assembly

Bolt Tightening Torque

When installing the tensioner on a base after attaching the idler sprocket to the tensioner, be sure to fasten the idler sprocket and the tensioner securely with a bolt. The table on the right indicates the tightening torque. Be sure to use bolts with a strength classification of 8.8T or more.

Checking the rotation of the idler sprocket

If the idler sprocket is anchored in place, check whether or not the sprocket can turn smoothly. If it does not turn smoothly, the bolt may be too tight. Loosen the bolt and then retighten properly.

Position adjustment

When setting the tensioner, adjust with a shim so that the center of the idler sprocket and chain are aligned.

Attachment bolt locking torque Unit: kN·m{kgf·m} Table 4

	Idler sprocket attachment bolt	Tensioner attachment bolt
CT-TCS40,50	0.02{2.0}	0.04{4.0}
CT-TCS60,80	0.03{3.0}	0.05{5.0}
CT-ETS40,50	0.03{3.0}	0.03{3.0}
CT-ETS60,80	0.04{4.0}	0.04{4.0}
CT-TA40	—	0.03{3.0}
CT-TA50,60	—	0.04{4.0}
CT-TA80	—	0.05{5.0}

★ Refer to Tables 1 and 2 for bolt size.

Chain Tensioners

Product type

1 TCS Type: Swing type, with idler sprocket

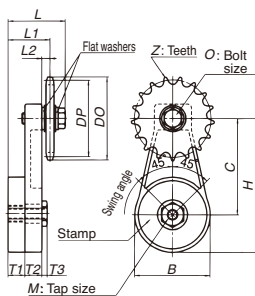

Ordering

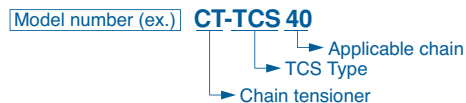

Ordering Example

Model number	Quantity	Unit (pcs)
CT-TCS40	1	K

Operating temperature : -10°C to 100°C

Note 1. Only the CT-TCS80 has two washers installed on each side.
2. The swing angle of CT-TCS60 and CT-TCS80 is 30°.

Produce code	Model Number	Stamp	Applicable Chain	B	C	H	M	T ₁	T ₂	T ₃	Z	DP	DO	O	L	L ₁	L ₂	Plunge Force kN{kgf}	Approximate Mass kg/unit
D210001	CT-TCS40	TC-1	RS40-1	69	87.5	122	M10	15.5	15.5	5	17	69.12	75	M10	50.5	37.5	6.5	0{0}~0.15{15}	0.74
D210002	CT-TCS50	TC-1	RS50-1	69	87.5	122	M10	15.5	15.5	5	15	76.35	83	M10	50.5	37.5	6.5	0{0}~0.15{15}	0.82
D210003	CT-TCS60	TC-2	RS60-1	90	100	145	M12	18	18	7	13	79.60	88	M12	60.5	44.5	8.5	0{0}~0.39{40}	1.30
D210004	CT-TCS80	TC-2	RS80-1	90	100	145	M12	18	18	7	11	90.16	101	M12	65.5	47	11	0{0}~0.39{40}	1.52

Note: 1. All models stocked.
2. The dimensions shown in this catalog are nominal dimensions and differ from actual dimensions.

2 ETS Type: Straight type, with idler sprocket

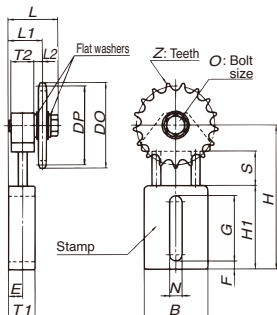

Ordering



Ordering Example

Model number	Quantity	Unit (pcs)
CT-ETS40	1	K

Operating temperature : -10°C to 100°C

Note: Only the CT-ETS80 has two washers installed on each side.

Produce code	Model Number	Stamp	Applicable Chain	S	H	H ₁	F	G	B	N	T ₁	T ₂	E	Z	DP	DO	O	L	L ₁	L ₂	Plunge Force kN{kgf}	Approximate Mass kg/unit
D210005	CT-ETS40	TO-1	RS40-1	30	129	74	7	58	56.2	11	23	20	12.5	17	69.12	76	M10	42	29	6.5	0.10{10}~0.25{25}	0.60
D210006	CT-ETS50	TO-1	RS50-1	30	129	74	7	58	56.2	11	23	20	12.5	15	76.35	84	M10	42	29	6.5	0.10{10}~0.25{25}	0.69
D210007	CT-ETS60	TO-2	RS60-1	38	163	87	9	70	70.5	12.5	28	25	15	13	79.60	89	M12	52	36	8.5	0.15{15}~0.39{40}	1.15
D210008	CT-ETS80	TO-2	RS80-1	38	163	87	9	70	70.5	12.5	28	25	15	11	90.16	102	M12	57	38.5	11	0.15{15}~0.39{40}	1.37

Note: 1. All models stocked.
2. Lubricate the rod section regularly.
3. The dimensions shown in this catalog are nominal dimensions and differ from actual dimensions.

3 TA Type: Straight type, with plastic shoe

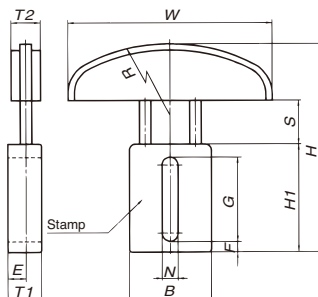

Ordering

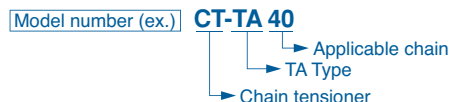

Ordering Example

Model number	Quantity	Unit (pcs)
CT-TA40	1	K

Operating temperature : -10°C to 60°C

Produce code	Model Number	Stamp	Applicable Chain	S	H	H ₁	F	G	B	N	T ₁	E	W	R	T ₂	Plunge Force kN{kgf}	Approximate Mass kg/unit
D210009	CT-TA40	TO-1	RS40-1	30	143	74	7	58	56.2	11	23	12.5	140	120	20	0.10{10}~0.25{25}	0.39
D210010	CT-TA50	TO-2	RS50-1	38	164	87	9	70	70.5	12.5	28	15	140	140	22	0.15{15}~0.39{40}	0.65
D210011	CT-TA60	TO-2	RS60-1	38	164	87	9	70	70.5	12.5	28	15	140	140	22	0.15{15}~0.39{40}	0.65
D210012	CT-TA80	TO-3	RS80-1	44	187	104	9	86	82	14.5	33	17.5	140	160	25	0.29{30}~0.59{60}	0.99

Note: 1. All models stocked.
2. Lubricate the rod section regularly.
3. The dimensions shown in this catalog are nominal dimensions and differ from actual dimensions.

Chain Tensioners

4 TH Type: Straight type, with idler sprocket

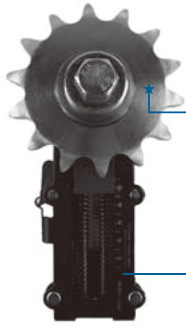

Choose your idler sprocket



Ball bearing type (Standard type)



Lube-free bush type (Optional type)

Unique ratchet and spring construction

The spring automatically controls chain sag and excessive vibration. The ratchet construction makes installation a snap.

CT-TH1 : For RS35-1 and RS40-1
CT-TH2 : For RS50-1, RS60-1, and RS80-1

Ordering

Model number

Main body/ adapter

CT-TH 1

Chain tensioner
Tensioner body size
TH: TH Type tensioner
THS: TH Type tensioner adapter

Idler sprocket

RS35-THB 20T

Applicable chain size
Idler sprocket no. of teeth
THB: Ball bearing type
THL: Lube-free bush type

Ordering Example

Model number	Quantity	Unit (pcs)
CT-TH1	1	K
RS35-THB20T	1	K
CT-THS1	1	K

Dimensions

Main Body

CT-TH1

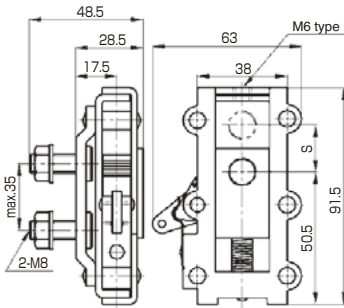

**"S" indicates "stroke."

CT-TH2

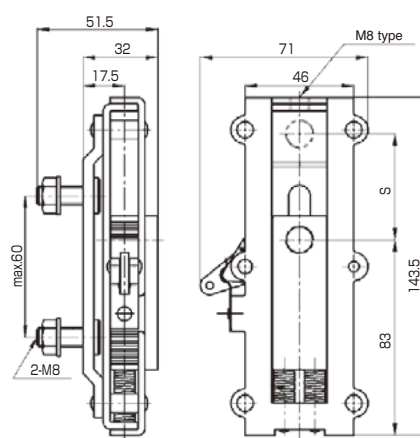

Model Number	Stroke S (mm)	Plunge Force (N)	
		Min.	Max.
CT-TH1	25	39.2	117.6
CT-TH2	45	98.0	294.0

Each package will contain the following.

Contains	Dimensions	CT-TH1	CT-TH2
Hexagonal Bolt	M12×45L	1	—
	M12×55L	—	1
Hexagonal Screw	M6×35L	1	—
	M8×55L	—	1
Round Head Screw	M8×23L	2	2
Hex Key		1	1
Spacer	Thickness: 3mm	1	3

Adapter (fixed washer)

CT-THS1

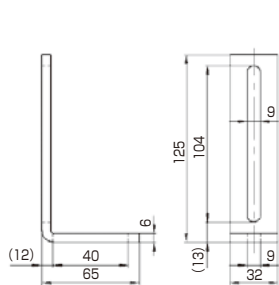

CT-THS2

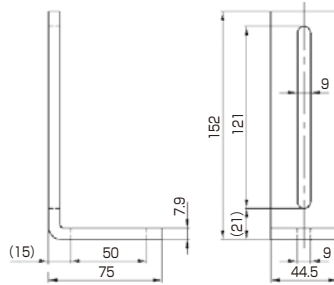

Model Number	Chain Tensioner
CT-THS1	CT-TH1
CT-THS2	CT-TH2

Idler Sprocket for TH Series

Ball Bearing Type

Lube-free Bush Type

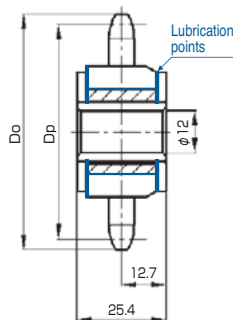
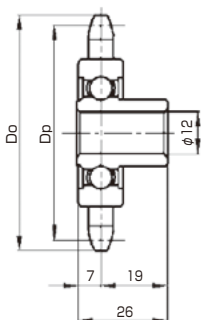

	Model Number	Idler No. of Teeth	Pitch Diameter (Dp)	Outer Diameter (Do)	Max. RPM	Allowable Bearing Load (N)
Ball Bearing Type	RS35-THB20T	20	60.89	66	3000	3300
	RS40-THB15T	15	61.08	67		
	RS50-THB15T	15	76.35	84		
	RS60-THB14T	14	85.61	95		
Lube-free Bush Type	RS80-THB11T	11	90.16	102	2500	343
	RS35-THL20T	20	60.89	66		
	RS40-THL15T	15	61.08	67		
	RS50-THL15T	15	76.35	84		
	RS60-THL14T	14	85.61	95		

*Thoroughly lubricate sliding areas of lube-free bush type idler sprockets before use.
Note: The dimensions shown in this catalog are nominal dimensions and differ from actual dimensions.

Chain Tensioners

Installation

Attaching the TCS type tensioner

- 1) Attach the roller chain to the drive and driven sprockets.
- 2) In order to attach the tensioner to the slack side of the roller chain as shown in Fig. 2, first push in on the roller chain with the idler sprocket and determine the attachment position (bolt hole) for the tensioner.

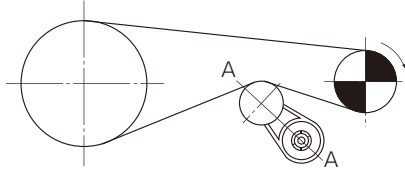

Fig. 2 Tensioner position (front)

- 3) Then, within a range where the roller chain does not contact the tensioner unit, ensure the force of the roller chain moves as perpendicular as possible to the A-A line. (Tensioner is a swing type unit.)

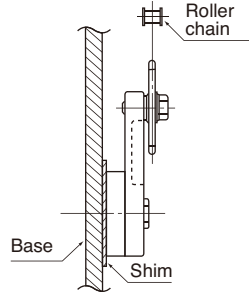

Fig. 3 Tensioner position (side)

- 4) Adjust with a shim, as shown in Fig. 3, so that the center of the roller chain and idler sprocket are aligned.

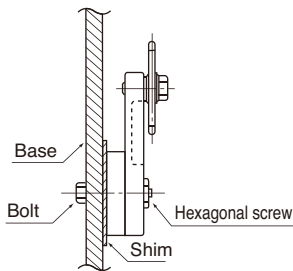

Fig. 4 Tightening the tensioner

- 5) Open a hole in the base that holds the tensioner. (A slotted hole is convenient.)
- 6) Push in on the chain with the tensioner and temporarily tighten the tensioner to the base with a bolt. (Fig. 4) Then tighten the hexagonal screw and anchor so that the swing angle is about 15°.

- 7) Perform a test operation and check whether the tensioner works properly. If any of the following occurs, reset the tensioner.

- Contacts the side of the idler sprocket: Not centered properly
- Vertical or traverse vibration: Insufficient initial tension
- Increased noise: Excessive initial tension

TH Type Tensioner Installation

- 1) Always insert the spacer where indicated (positions A & B) as shown in Dia. 8 when installing the idler sprocket on the tensioner. (Failure to insert the spacer will result in tensioner contact with the roller chain. See Table 5.) Attach the hub so that it faces the tensioner when installing ball bearing type idler sprockets. When attaching on the opposite side, install the number of spacers indicated in parentheses in Table 5.

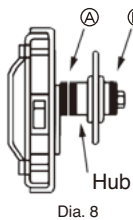

Dia. 8

- 2) The tensioner stop should be positioned facing down (spring facing down) as per the diagram on the left.

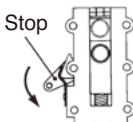

Dia. 9

- 3) Once the round head bolts are attached to the tensioner as shown, attach the adapter and tighten the nuts just until snug.

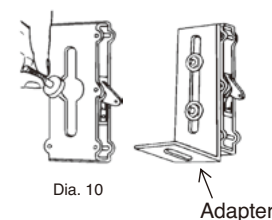

Dia. 10

Adapter

⚠ Caution: Always install chain tensioners on the roller chain sag side. Tensioners cannot be installed on the tension side or used when the chain is run backwards.

Attaching the ETS and TA Type tensioners

- 1) Push in on the roller chain with the tensioner's idler sprocket (Fig. 5) and determine the position of the hole on the attachment base.

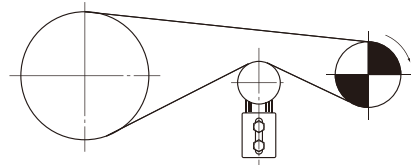

Fig. 5 Tensioner position (front)

- 2) Open a hole in the attachment base. In this case, two bolt holes are required, but a hole that is as long as possible will make positioning simpler, and the re-tensioning operation will be easier when the chain elongates.

- 3) Temporarily tighten the tensioner with two bolts. At this time, adjust with a shim, etc., so that the center of the idler sprocket and roller chain are aligned. (Fig. 6)

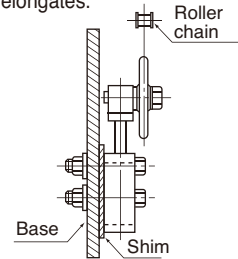

Fig. 6 Tightening the tensioner

- 4) Push in on the chain with the tensioner and, if the amount of slack is appropriate (δ), tighten the nut and anchor the tensioner. Aim for a value less than $\delta = 0.02 \times L$. (Fig. 7)

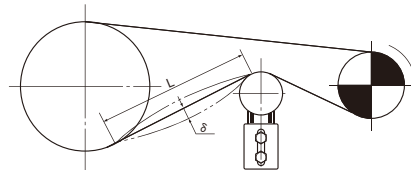

Fig. 7 Tensioner's anchored position

- 5) Perform a test operation and check whether the tensioner works properly. If any of the following occurs, reset the tensioner.

- Contacts the side of the idler sprocket: Not centered properly
- Vertical or traverse vibration: Insufficient initial tension
- Increased noise: Excessive initial tension

- 4) Frame, Take-up block, Coil spring
- Attach a hexagonal screw to the tap hole on the end of the tensioner. Use the hex key to tighten the screw, and push the take-up block down as far as possible. (Caution: Failure to perform action 2) above will prevent the take-up block from being pushed down.)

Dia. 11

- 5) Once the drive and driven sprockets have been aligned, fix the adapter to the attachment area using a mounting bolt ("C", bolt not included).

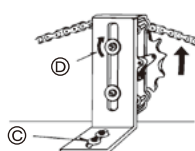

- 6) Once the chain is engaging the sprocket, tighten the adapter mounting nuts ("D"). Next, after inverting the tensioner stop as shown by the arrow in Dia. 9, removing the hexagonal screw will activate the spring. Installation is now complete. Check the condition of the roller chain sag and the installation itself.

Number of Spacers Table 5

Idler Sprocket		Number of Spacers	
Type	Model Number	"A" side in Dia. 8	"B" side in Dia. 8
Ball Bearing	RS35-THB20T	0 (1)	1 (0)
	RS40-THB15T	0	1
	RS50-THB15T	0 (3)	3 (0)
	RS60-THB14T	0	3
	RS80-THB11T	2	1
Lube-free Bush	RS35-THL20T	0	1
	RS40-THL15T	1	0
	RS50-THL15T	2	1
	RS60-THL14T	3	0

FR Idler Sprockets



Free Running

Bearing units with hubs provide stable rotation!

Idler sprockets are a must with chain drives, and Tsubaki offers a wide-variety of idler sprockets to choose from

Model/Series

1. Chain number and no. of teeth (all teeth hardened)

	9	10	11	12	13	14	15	16	17	18	19	20	21	22	23	24	25
RS35										●	●	●	●	●	●	●	●
RS40						●	●	●	●	●	●	●					
RS50				●	●	●	●	●	●								
RS60			●	●	●	●											
RS80	●	●	●	●	●												

2. Bearing Series

Ball Bearing Series (B) Oilless Bush Series (L)

3. Surface Treated Series (photos above show plated idlers)

No plating (N) Electroless nickel phosphorous plating (K)

Model Numbering Example

FR B - RS40 - 15TQ - N

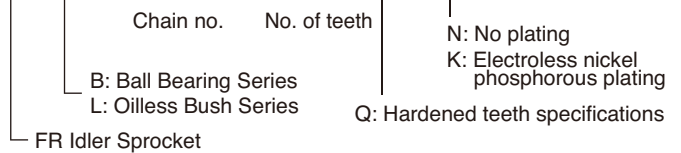

Application Examples

• Take up slack on long center distances

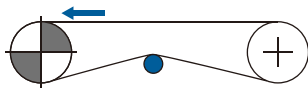

• Function as a center idler on drives with multiple shafts

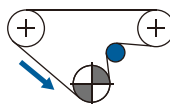

• When chain wrap angle is insufficient

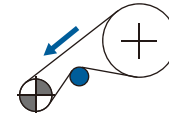

List of Models

Ball Bearing Series (no plating)

Model No.
FRB - RS35 - 18TQ - N
FRB - RS35 - 19TQ - N
FRB - RS35 - 20TQ - N
FRB - RS35 - 21TQ - N
FRB - RS35 - 22TQ - N
FRB - RS35 - 23TQ - N
FRB - RS35 - 24TQ - N
FRB - RS35 - 25TQ - N
FRB - RS40 - 14TQ - N
FRB - RS40 - 15TQ - N
FRB - RS40 - 16TQ - N
FRB - RS40 - 17TQ - N
FRB - RS40 - 18TQ - N
FRB - RS40 - 19TQ - N
FRB - RS40 - 20TQ - N
FRB - RS50 - 12TQ - N
FRB - RS50 - 13TQ - N
FRB - RS50 - 14TQ - N
FRB - RS50 - 15TQ - N
FRB - RS50 - 16TQ - N
FRB - RS50 - 17TQ - N
FRB - RS60 - 11TQ - N
FRB - RS60 - 12TQ - N
FRB - RS60 - 13TQ - N
FRB - RS60 - 14TQ - N
FRB - RS80 - 9TQ - N
FRB - RS80 - 10TQ - N
FRB - RS80 - 11TQ - N
FRB - RS80 - 12TQ - N
FRB - RS80 - 13TQ - N

Oilless Bush Series (no plating)

Model No.
FRL - RS35 - 18TQ - N
FRL - RS35 - 19TQ - N
FRL - RS35 - 20TQ - N
FRL - RS35 - 21TQ - N
FRL - RS35 - 22TQ - N
FRL - RS35 - 23TQ - N
FRL - RS35 - 24TQ - N
FRL - RS35 - 25TQ - N
FRL - RS40 - 14TQ - N
FRL - RS40 - 15TQ - N
FRL - RS40 - 16TQ - N
FRL - RS40 - 17TQ - N
FRL - RS40 - 18TQ - N
FRL - RS40 - 19TQ - N
FRL - RS40 - 20TQ - N
FRL - RS50 - 12TQ - N
FRL - RS50 - 13TQ - N
FRL - RS50 - 14TQ - N
FRL - RS50 - 15TQ - N
FRL - RS50 - 16TQ - N
FRL - RS50 - 17TQ - N
FRL - RS60 - 11TQ - N
FRL - RS60 - 12TQ - N
FRL - RS60 - 13TQ - N
FRL - RS60 - 14TQ - N
FRL - RS80 - 9TQ - N
FRL - RS80 - 10TQ - N
FRL - RS80 - 11TQ - N
FRL - RS80 - 12TQ - N
FRL - RS80 - 13TQ - N

FR Idler Sprockets

List of Model Numbers and Dimensions

All models have hardened teeth

Model No.	Chain	No. of Teeth N	Pitch Dia. Dp(mm)	Outer Dia. Do(mm)	Tooth Width T(mm)
FR□ - RS35 - 18TQ - ■	RS35	18	54.85	60	4.4
FR□ - RS35 - 19TQ - ■		19	57.87	63	
FR□ - RS35 - 20TQ - ■		20	60.89	66	
FR□ - RS35 - 21TQ - ■		21	63.91	69	
FR□ - RS35 - 22TQ - ■		22	66.93	72	
FR□ - RS35 - 23TQ - ■		23	69.95	75	
FR□ - RS35 - 24TQ - ■		24	72.97	78	
FR□ - RS35 - 25TQ - ■		25	76.00	81	
FR□ - RS40 - 14TQ - ■	RS40	14	57.07	63	7.3
FR□ - RS40 - 15TQ - ■		15	61.08	67	
FR□ - RS40 - 16TQ - ■		16	65.10	71	
FR□ - RS40 - 17TQ - ■		17	69.12	75	
FR□ - RS40 - 18TQ - ■		18	73.14	78	
FR□ - RS40 - 19TQ - ■		19	77.16	83	
FR□ - RS40 - 20TQ - ■		20	81.18	88	
FR□ - RS50 - 12TQ - ■	RS50	12	61.34	68	8.9
FR□ - RS50 - 13TQ - ■		13	66.33	73	
FR□ - RS50 - 14TQ - ■		14	71.34	79	
FR□ - RS50 - 15TQ - ■		15	76.35	84	
FR□ - RS50 - 16TQ - ■		16	81.37	89	
FR□ - RS50 - 17TQ - ■		17	86.39	94	
FR□ - RS60 - 11TQ - ■	RS60	11	67.62	76	11.9
FR□ - RS60 - 12TQ - ■		12	73.60	82	
FR□ - RS60 - 13TQ - ■		13	79.60	89	
FR□ - RS60 - 14TQ - ■		14	85.61	95	
FR□ - RS80 - 9TQ - ■	RS80	9	74.26	85	15.0
FR□ - RS80 - 10TQ - ■		10	82.20	93	
FR□ - RS80 - 11TQ - ■		11	90.16	101	
FR□ - RS80 - 12TQ - ■		12	98.14	108	
FR□ - RS80 - 13TQ - ■		13	106.14	118	

Ball Bearing Series

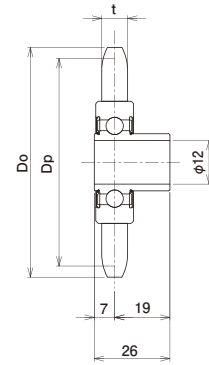

Oilless Bush Series

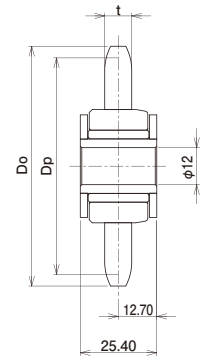

Note: 1. Enter the bearing code (B/L) in the white boxes and surface treatment code (N/K) in the black boxes. (See the previous page for details.)

2. The dimensions shown in this catalog are nominal dimensions and differ from actual dimensions.

Example of Idler Sprocket Mounting

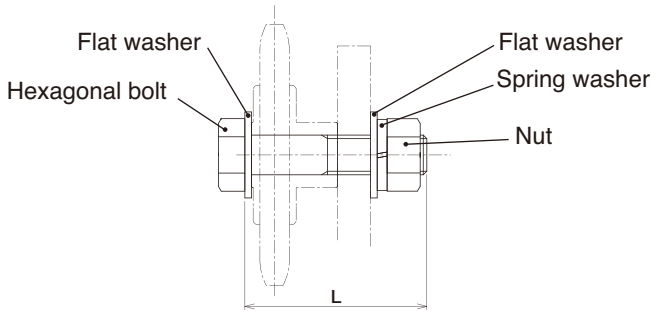

Idler Bolt Set Models

Model No.	Size	L(mm)
FR-PS45	M12	45
FR-PS55		55
FR-PS70		70



Accessory

Comes with one (1) bolt, one (1) nut, three (3) flat washers, and one (1) spring washer. (Surface treatment: trivalent chromate)

Chain Cutting Tools

Tsubaki provides roller chains in either unit lengths (3048 mm) or reels. The following tools are available for cutting the chain to a desired length. See "Roller Chain and Sprocket Handling" for use.

Ordering

Ordering Example

Model number Qty Unit (pcs)
RS-CR1 1 K

1 Chain Vises

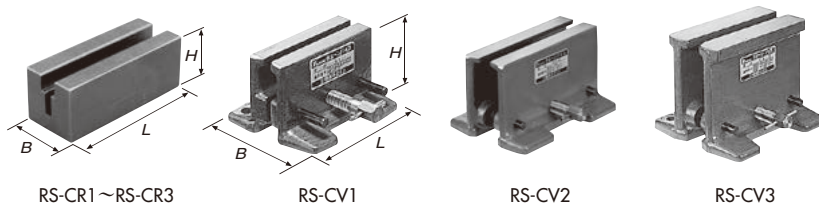

Model Number	Applicable Chain			Dimensions		
	Single-strand	Double-strand	Triple-strand	L	H	B
RS-CR1	RS15	—	—	50	16.4	20
RS-CR2	RS25	—	—	50	19	20
RS-CR3	RS35	—	—	60	30	30
RS-CV1	RS40~80	RS40	—	100	65	94~115
RS-CV2	RS40~160	RS40~100	RS40~100	180	110	120~151
RS-CV3	RS80~240	RS80~160	RS80~100	200	170	180~220

Note: 1. All models stocked.
 2. The dimensions shown in this catalog are nominal dimensions and differ from actual dimensions.

2 Punches

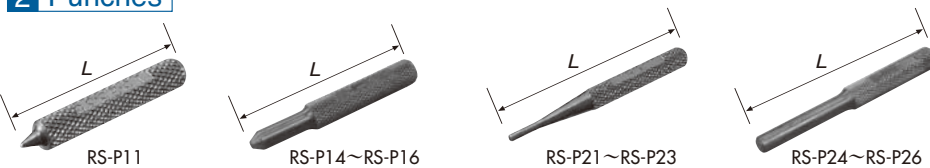

Primary punch		Secondary punch		Applicable Chain
Model Number	L	Model Number	L	
RS-P11	52	RS-P21	65	RS15
		RS-P22	70	RS25
		RS-P23	80	RS35
RS-P14	60	RS-P24	80	RS40~60
RS-P15	70	RS-P25	90	RS80~120
RS-P16	80	RS-P26	120	RS140~240

Note: 1. All models stocked
 2. RS-P11 is for RS15, RS25, and RS35 chains
 3. The dimensions shown in this catalog are nominal dimensions and differ from actual dimensions.

3 Chain Breakers

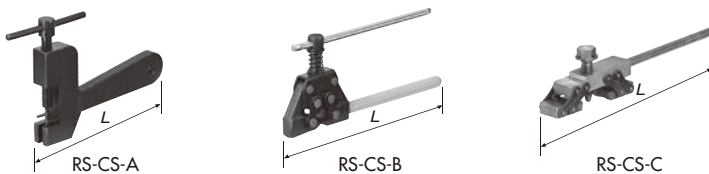

Model Number	L	Applicable Chain (Single-strand)	Model Number	L	Applicable Chain (Single-strand & Double-strand)
RS-CS-A1	116	RS25	RS-CS-B1	185	RS40~60
RS-CS-A2	119	RS35	RS-CS-C1	222	RS80 · 100
RS-CS-A3	119	RS41	RS-CS-C2	290	RS120 · 140
RS-CS-A4	119	RF06B	RS-CS-C3	708	RS160~240

Note: 1. All models stocked. Chain breakers for BS/DIN Roller Chain also available.
 2. Not for use with RS35-LMC, RF05B chain.
 3. The dimensions shown in this catalog are nominal dimensions and differ from actual dimensions.

Chain Cutting Tools

4 Poly Steel Chain Cutting Tools

Standard chain cutting tools cannot be used on Poly Steel Chains. A special punch and vise for Poly Steel Chains are required.

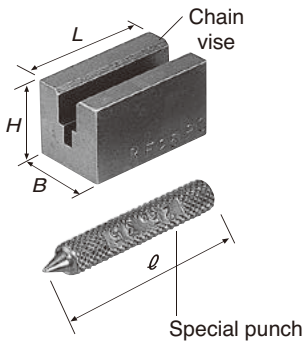

<Cutting Tools>

Model Number	L	H	B	ϕ	Applicable Chain
RS-PC01-AST	35	20	20	52	RS25-PC-1
RS-PC02-AST	50	30	30	52	RS35-PC-1
RS-PC03-AST	65	35	35	56	RS40-PC-1
RS-PC04-AST	80	40	35	56	RS50-PC-1
RS-PC05-AST	100	45	40	56	RS60-PC-1

- Note: 1. All models stocked.
 2. Special punch and vise are included as a set.
 3. The dimensions shown in this catalog are nominal dimensions and differ from actual dimensions.

5 Lambda Chain Cutting Tools

A special vise and a primary and secondary punch are required to disassemble Lambda Chains.

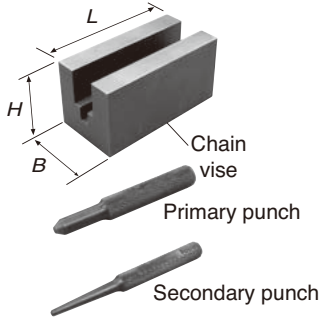

<Cutting Tools>

Model Number	L	H	B	Applicable Chain
RS-LMD01-AST	65	32	32	RS40-LMD-1
RS-LMD02-AST	80	40	40	RS50-LMD-1
RS-LMD03-AST	95	48	48	RS60-LMD-1
RS-LMD04-AST	130	60	60	RS80-LMD-1
RS-LMD05-AST	160	73	73	RS100-LMD-1
RS-LMD06-AST	160	88	88	RS120-LMD-1
RS-LMD07-AST	180	98	98	RS140-LMD-1
RS-LMD08-AST	200	114	114	RS160-LMD-1

- Note: 1. All models stocked.
 2. Special punch and vise are included as a set.
 Punch dimensions are the same as for punches in 2. above.
 3. The dimensions shown in this catalog are nominal dimensions and differ from actual dimensions.

Chain Connecting Tool

1 Chain Puller

This tool pulls the two ends of the chain together when installing the chain on a machine.

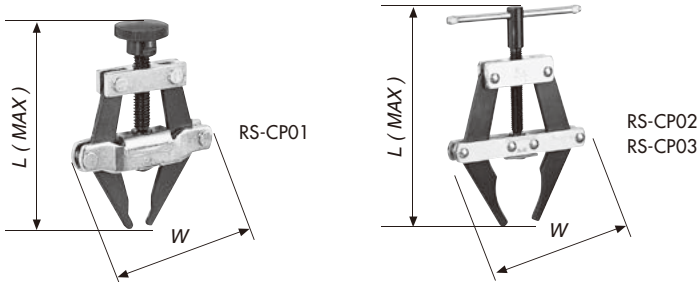

Model Number	L	W	Applicable Chain (Single-strand)
RS-CP01	118	70	RS35~60
RS-CP02	185	112	RS60~100
RS-CP03	250	145	RS80~240

- Note: 1. All models stocked.
 2. The dimensions shown in this catalog are nominal dimensions and differ from actual dimensions.

End Fixtures

- Allow for reliable lifting equipment using RS Roller Chain.
- Designed to be stronger than RS Roller Chains, they sufficiently demonstrate RS Roller Chain's performance when connected to a chain with appropriate clearance.

Ordering



Ordering Example

Model number	Qty	Unit
RS40EB	1	K

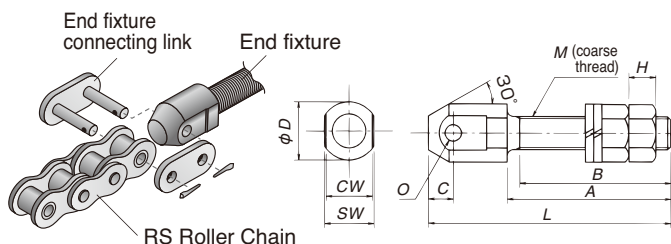

1 End Fitting Bolts (for RS Roller Chains)

Model Number	Applicable Chain	L	A	B	C	M	O	D	CW	SW	H	Approximate Weight kg/unit
RS40EB	RS40-1	61.0	41.5	38	6.0	M 8	4.00	15	11.2	13.0	6.5	0.04
RS50EB	RS50-1	72.5	48.5	44	7.5	M10	5.12	19	13.8	17.0	8.0	0.07
RS60EB	RS60-1	89.1	60.0	55	9.1	M12	5.99	21	17.8	19.0	10.0	0.12
RS80EB	RS80-1	117.1	79.0	73	12.1	M16	7.98	28	22.6	24.0	13.0	0.27
RS100EB	RS100-1	145.1	98.0	91	15.1	M20	9.58	34	27.5	30.0	16.0	0.51
RS120EB	RS120-1	173.1	117.0	108	18.1	M24	11.15	40	35.5	35.5	19.0	0.86

- Note: 1. SW dimensions are designed for wrench use.
 2. Uses old JIS B1181 (type 1) nuts and JIS B1251 spring washers.
 3. Black coating.
 4. All models stocked.
 5. The dimensions shown in this catalog are nominal dimensions and differ from actual dimensions.

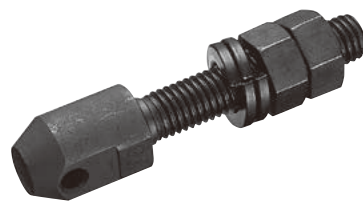

2 End Fitting Bolt Connecting Links (for RS Roller Chains)

Model Number	Applicable Chain	P	H	D	T	L ₁	L ₂	Approximate Weight kg/unit
RS40EB-CL	RS40-1	12.70	12.0	3.97	2.0	8.8	10.2	0.01
RS50EB-CL	RS50-1	15.875	15.0	5.09	2.4	10.7	12.3	0.02
RS60EB-CL	RS60-1	19.05	18.1	5.96	3.2	14.0	16.1	0.04
RS80EB-CL	RS80-1	25.40	24.0	7.94	4.0	17.5	20.1	0.09
RS100EB-CL	RS100-1	31.75	28.6	9.54	4.8	21.0	23.7	0.156
RS120EB-CL	RS120-1	38.10	34.4	11.11	5.6	26.05	29.55	0.264

- Note: 1. All models stocked.
 2. Use an F-type connecting link if there is a risk of lateral forces acting on the end bolt.
 3. Contact a Tsubaki representative regarding connecting/end links with different shapes.
 4. The dimensions shown in this catalog are nominal dimensions and differ from actual dimensions.

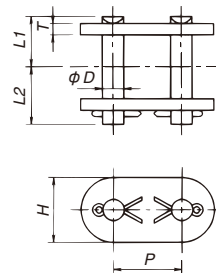

Strength

Strength when Tsubaki RS Roller Chains (except for M-type connecting links and offset links) are connected to end fitting bolts, and special connecting links are as follows.

Applicable Chain	RS40-1	RS50-1	RS60-1	RS80-1	RS100-1	RS120-1
Minimum Tensile Strength kN{kgf}	17.7{1800}	28.4{2900}	40.2{4100}	71.6{7300}	107{10900}	148{15100}
Maximum Allowable Load kN{kgf}	3.63{370}	6.37{650}	8.83{900}	14.7{1500}	22.6{2300}	30.4{3100}

⚠ Safety Precautions

- Operating temperature: -10 to 60°C (Contact a Tsubaki representative for use in special environments.)
- Use the Tsubaki End Fitting Bolt Connecting Link when connecting an end fitting bolt and an RS Roller Chain. We recommended disassembling and lubricating regularly for safety.
- Do not use M-type connecting links for RS Roller Chains (that have a gap between the pin and connecting link plate) or offset links.
- Use only RS Roller Chains. These end fixtures cannot be used with Lube-Free Drive Chains, Heavy Duty Roller Chains, Super-H Roller Chains, and Ultra Super Roller Chains. (When using a Super Chain, always use a Super Chain connecting link.)
- Grease the surface of the connecting link pin in advance when attaching the end fitting bolt and RS Roller Chain. Take care to attach precisely and avoid twisting the chain.
- Attach so that there is no bending load on the end fitting bolt.
- Do not subject the threads or head of the end fitting bolt to impacts or cause them to become distorted.
- Tsubaki recommends periodically disassembling, inspecting, and lubing your end fixtures.

Automatic Lubricators for Roller Chain

■ Features

1. High safety and reliability

The lubricator, certified with the GS mark from German TÜV safety standards, is filled with grease that satisfies international FDA and NSF (formerly USDA) standards for use in food processing. Tsubaki auto lubricators help you increase safety in HACCP systems and contribute to your product liability countermeasures.

2. Usable in explosion-proof applications

Passed screening by TIIS, a non-governmental/non-profit organization recognized by the Minister of Health, Labor, and Welfare, and is certified as an explosion-protected electrical apparatus. There is no risk of explosion or fire from sparks or high temperatures from electrical apparatuses in environments with explosive gas, proving its safety.

3. Service life adjustable

You can easily set the service life to between 1 – 12 months with just an Allen wrench. Once set, the unit automatically operates by means of a gas generator.

4. Reduced maintenance time, features an inspection window

Automatic lubrication eliminates the need for frequent manual lubrication, which simplifies your lubrication schedule. The transparent PET plastic lubricator also features an inspection window so you can always check remaining lube and operating condition.

5. Lightweight, compact

Compact, with a diameter of $\phi 50$ and a height of 114mm (125mL), and weighing only 190g.

6. Can be installed in any direction

The lubricator can be installed facing up, down, or horizontally. However, if a brush is used it must be installed facing down.

7. Dust and waterproof

Certified IP68 as dust and waterproof for use in dusty or watery environments.

Body
Model no.: SFM68

Clamp (optional)
Model no.: SFM-ST2010

Brush (optional)
Model no.: SFM-ST2034

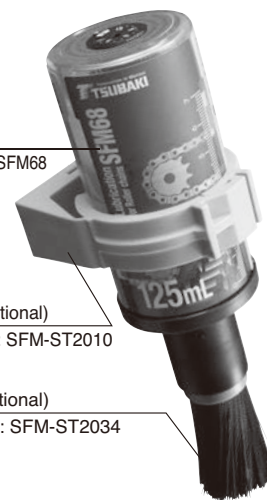

■ Ordering

● Ordering Example

Model No.	Qty	Unit (pc)
SFM68	1	K

■ Specifications

Operation	Hs gas pressure (dry battery type)
Operational pressure	Max. 0.5MPa
Volume	125ml
Discharge period	1 – 12 months, stepless (at an ambient temperature of 20°C)
Operating temperature range	-20 to 55°C
Oil	Food grade oil (H1)

■ Dimensions

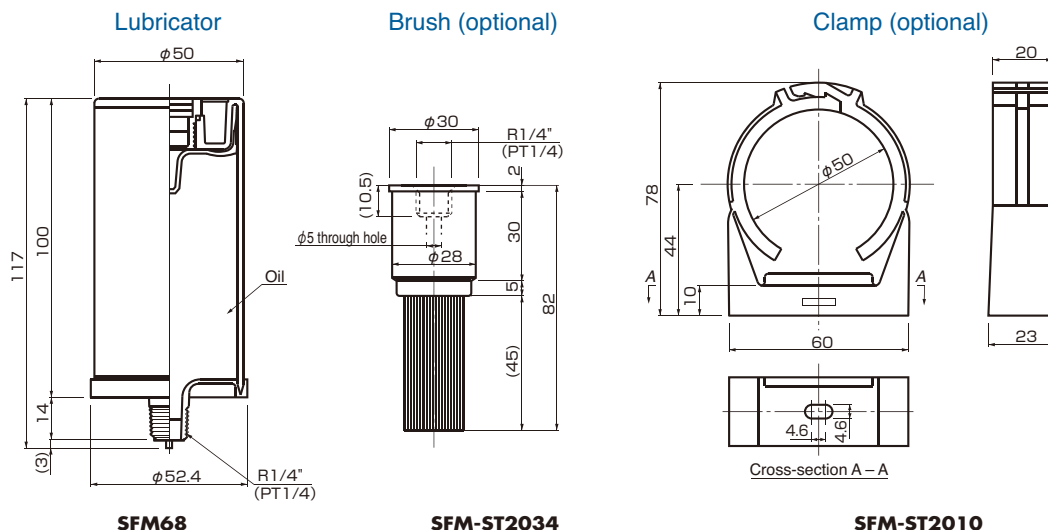

Automatic Lubricators for Roller Chain

Operating principle

Turning on the gas generator switch generates H₂ gas, the pressure of which pushes down on a piston and releases oil from the bottom of the lubricator. Setting the time adjustment dial allows users to control the amount of H₂ gas generated for 1 – 12 months, thereby adjusting oil flow in one single step.

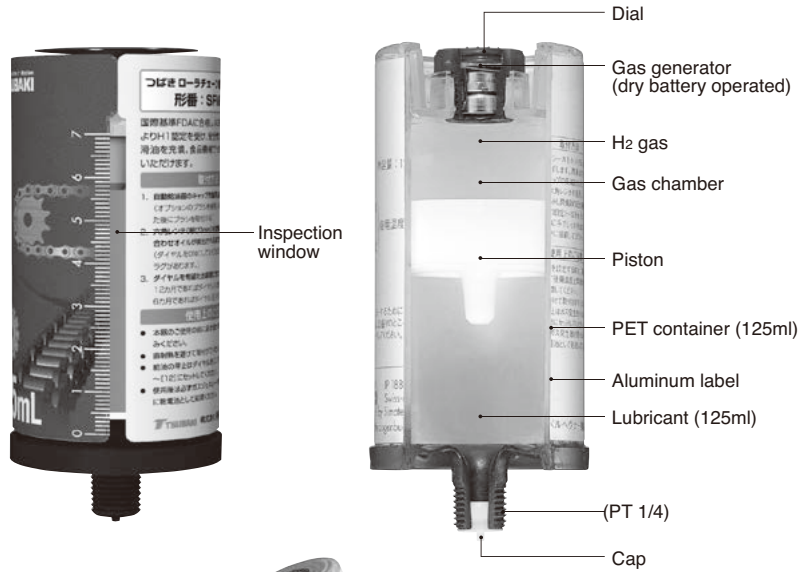

Installation

Position the lubricator with the optional brush attached on the chain sag side so that lubricant can penetrate between the outer and inner plates. This will ensure the area between bushes and rollers are lubricated as well. The lubricator brush should lightly touch the chain plates. (See diagram on right.) Secure the optional clamp by drilling a tap hole in a bar or the like and securing with an M4 bolt, or by drilling a hole that an M4 bolt can pass through and securing with a nut. (See diagram on bottom right.)

Caution: The automatic lubricator should be used with roller chains operating in the "brush lubrication" or "drip lubrication" range. This product will not provide enough lubrication for roller chains used in the "oil bath" or "forced lubrication" range and should not be used.

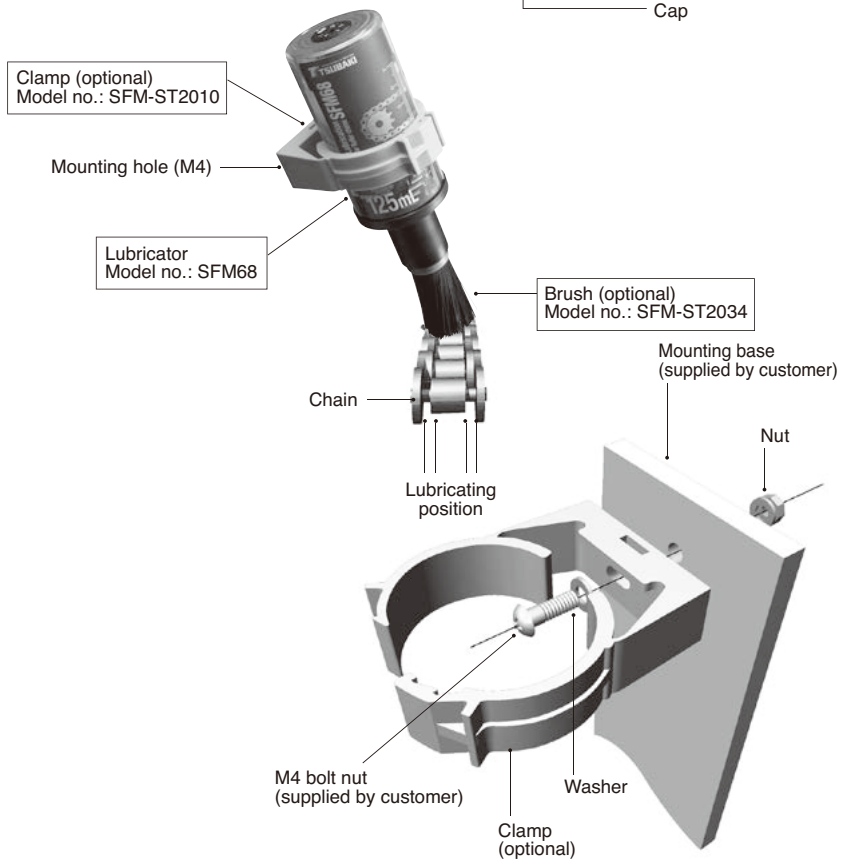

[Recommended Usage Range]

- Chain sizes
 - Drive chain (single stand): #40 - #100
 - Small size conveyor chain: #40 - #100
 - #2040 - #2100
- Chain speed
 - Less than 50m/min
- Current lubrication method
 - Brush or drip lubrication

Notes on Usage

- The amount of oil dispensed varies with ambient temperature. Especially, the amount of lubricant released will be lower in lower temperatures, so the dial should be set to a lower value (shorter than your desired discharge time). (See diagram on right.)
- The length of the lubrication path (piping) should be less than 0.5m, with an inner diameter greater than 6mm. The path should also not be segmented.
- CAUTION: Do not use where exposed to flame or direct sunlight.
- When stopping lubricant discharge midway, be sure to set the dial to zero "0."

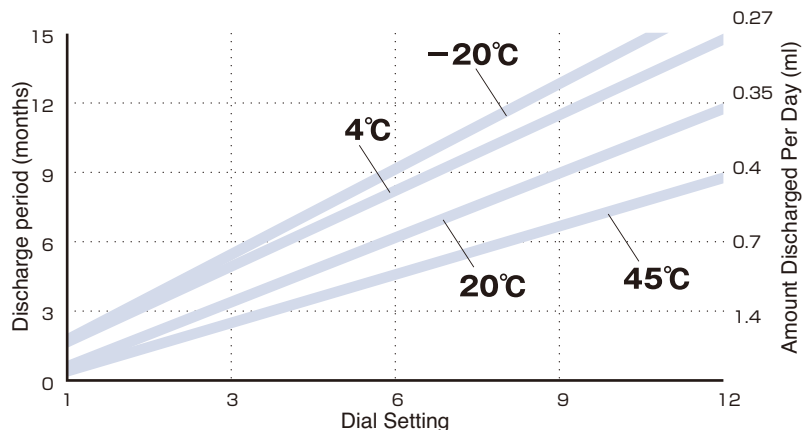

Chain Elongation Scales

The chain elongation scale allows for quick checks of a chain's pitch elongation limit.

Used to check chain elongation on RS Roller Chains, BS Roller Chains, and Leaf Chains to determine when it is time for the chain to be replaced.

■ Ordering

● Ordering Example

Model number	Qty	Unit
RS-CES	1	C

Note: 10 items per case

■ Applicable chain sizes

RS Roller Chains:	RS40 to RS240
BS/DIN Roller Chains:	RS08B to RS40B
Leaf Chains (AL/BL):	#4 to #16
Small size conveyor chain:	RF2040 – RF2120

■ Measurement procedure

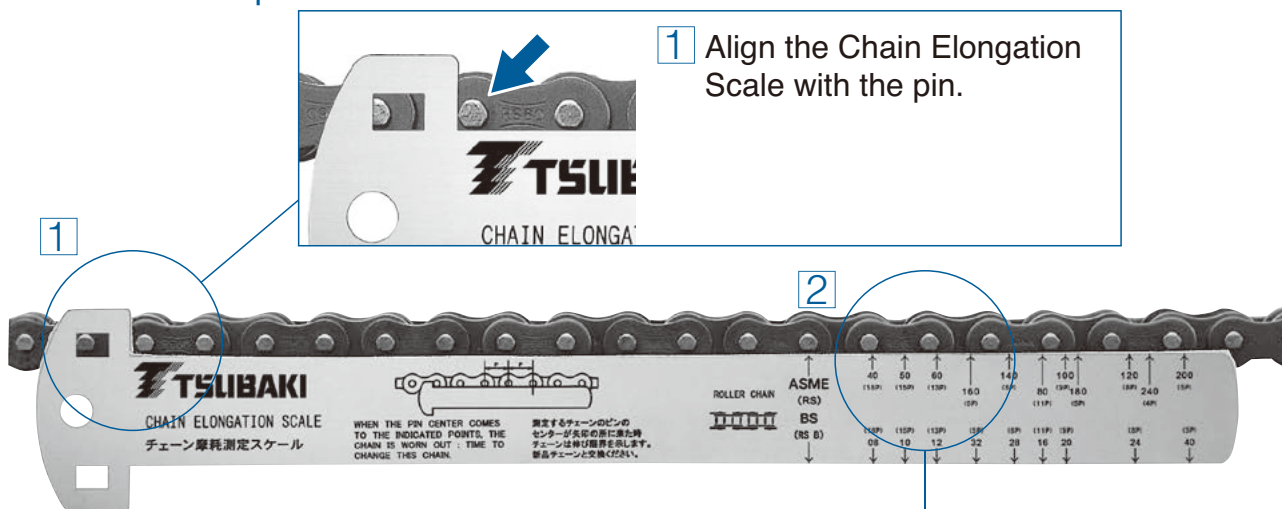

2 Check where along the scale the pin is positioned (pitch indicated in parentheses).

Scale positioning on a new product

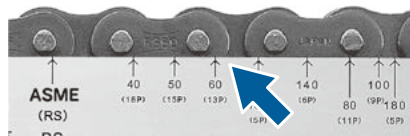

Wear elongation limit

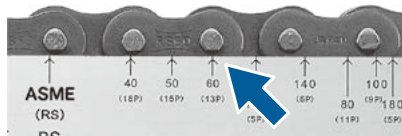

If the point of the scale is past the center of the pin, the chain has reached its elongation limit and should be replaced.

⚠ Safety Precautions

- Depending on the attachment and chain size, there may be interference with the Elongation Scale for specialty attachment chains or K2 attachment chains (catalog item).
- Check chain elongation at the location on the chain where the sprocket teeth engage the most.
- Check chain elongation at a location on the chain where tensile force is applied.
- Do not use the scale for any purpose other than measuring chain elongation.
- Always turn off the power switch to the equipment and confirm that it has come to a complete stop before checking chain elongation. In addition, make sure that the switch cannot be turned on accidentally.

Roller Chain / Sprocket Selection, Installation, and Maintenance

$$L = \frac{Z + Z'}{2} + 2C + \frac{\left(\frac{Z - Z'}{6.28}\right)^2}{C} \quad V = \frac{P \times Z' \times n}{1000} \text{ (m/min)}$$

$$F_m = \frac{60 \times kW}{V} \text{ (kN)}$$

$$L = \frac{180^\circ}{\tan^{-1}\left(\frac{P}{D + 2S}\right)} \quad I_r = M \times \left(\frac{Y}{2\pi n}\right)^2 \text{ (kg} \cdot \text{m}^2)$$

$$T_n = 9.55 \times \frac{kW}{n_1} \text{ (kN} \cdot \text{m)}$$

$$T_r = \frac{M \times d}{2 \times 1000 \times j} \times \frac{G}{1000} \text{ (kN} \cdot \text{m)}$$

$$T_c = F'c \times \frac{1}{2 \times 1000 \times j} \text{ (kN} \cdot \text{m)}$$

$$T_m = \frac{T_s(\%) + T_b(\%)}{2 \times 100} \times T_n \text{ (kN} \cdot \text{m)}$$

$$\text{Final } T_m = \frac{T_s(\text{kN} \cdot \text{m}) + T_b(\text{kN} \cdot \text{m})}{2} \text{ (kN} \cdot \text{m)}$$

$$F_{ms} = \frac{T_s(\%) \times 1}{11(2 \times 1000) \times 100} \times T_n \times 1 \text{ (kN)}$$

$$\text{Final } F_{ms} = \frac{T_s(\text{kN} \cdot \text{m}) \times 1}{11(2 \times 1000) \times 100} \times 1 \text{ (kN)}$$

$$F_{mb} = \frac{T_b(\%) \times 1}{11(2 \times 1000) \times 100} \times T_n \times 1 \text{ (kN)}$$

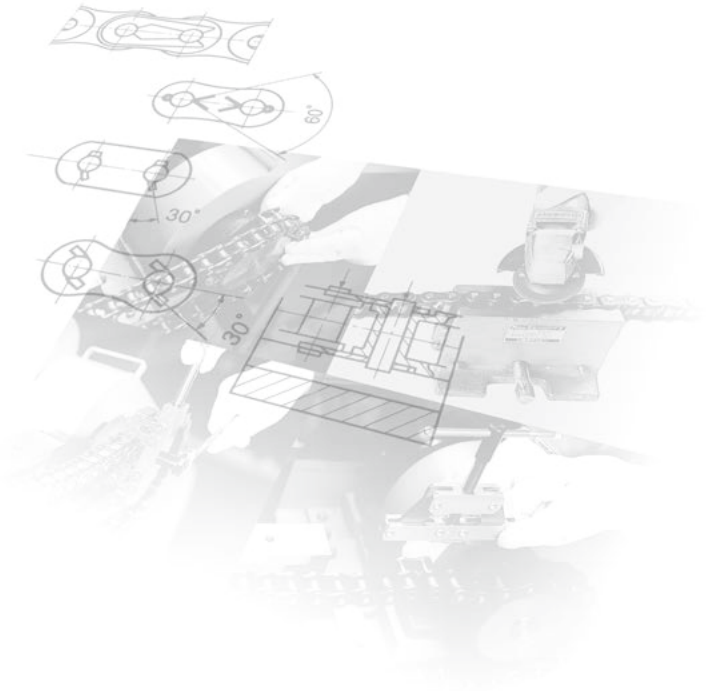

- 1. Selection Guide Pg. 172
- 2. Service Factors Pg. 174
- 3. Provisional Selection Chart .. Pg. 175
- 4. Selection Formulae Pg. 177
- 5. General Selection Pg. 180
- 6. Allowable Load Selection ... Pg. 182
- 7. Example of Lifting Transmissions .. Pg. 187
- 8. Calculating Moment of Inertia .. Pg. 189
- 9. Example of Shuttle Traction .. Pg. 190
- 10. Pin Gear Drive Selection ... Pg. 191
- 11. Temperature Selection Pg. 197
- 12. Special Selection Method for Corrosion Resistant Roller Chain .. Pg. 197
- 13. Corrosion Resistance Guide for Drive Chains and Sprockets .. Pg. 198

- 1. How to Cut Roller Chain ... Pg. 199
- 2. How to Connect Roller Chain ... Pg. 200
- 3. Roller Chain Lubrication ... Pg. 201
- 4. Layout and Installation Pg. 203
- 5. Sprockets Pg. 205
- 6. Chain Test Run Pg. 206
- 7. Roller Chain Inspection Pg. 206
- 8. Cautions on Use in Special Environments .. Pg. 210
- 9. Troubleshooting Pg. 211

Roller Chain Selection

1. Selection Guide

Application — Key points for selection — **Selection method**

Ordinary transmission — Selection using kilowatt ratings tables — **General selection method**
Page 180

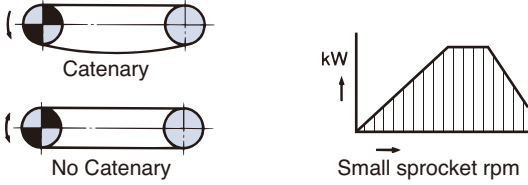

Ordinary transmission — Selection based on maximum allowable load — **Allowable load selection method**
Page 182

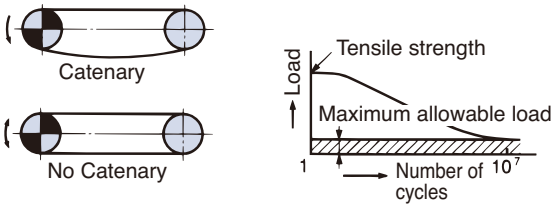

Lifting applications — Selection based on maximum allowable load — **Example of lifting transmissions**
Page 187



For connecting links, use F-type connecting links or connecting links for end fixtures. (Pg. 158, for RS chains only.)

Shuttle traction — Selection based on maximum allowable load — **Example of shuttle traction**
Page 190

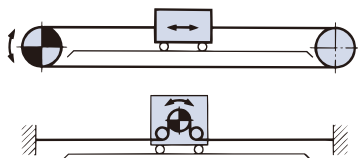

Pin gear drive — Selection based on maximum allowable load (Chain speed $V = 50$ m/min or less) — **Pin gear drive selection**
Page 191

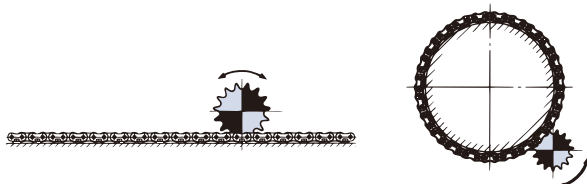

Chain Type	Connecting parts that can be used in a normal atmosphere from -10°C to 60°C.			
	M type CL	F type CL	2-pitch OL	1-pitch OL
RS	○	○	○	□
BS/DIN	○	○	□	□
RS-LMD	○	○	—	□
RS-LMD-S	○	○	—	—
RS-LMD-NP	○	—	—	□
RS-LMDX	○	—	—	—
BS-LM	○	—	—	□
RS-SUP	○	○	—	—
RS-HT	○	○	—	—
RS-SNS	○	○	○	□
RS	○	○	○	△
BS/DIN	○	○	△	△
RS-SUP	○	○	—	—
RS-HT	○	○	—	—
RS-SUP-H	—	○	—	—
RF-US-N	—	○	—	—
NP	○	○	—	△
NEP	○	○	—	—
SS, AS	○	—	—	○
RS-PC	○	—	—	—
RS-PC-SY	○	—	—	—
NS	○	—	—	○
TI	○	—	—	○
KT	△	○	—	△
RS-CU	○	○	—	—
RS-CU-SS	○	—	—	—
RS Attachment	○	—	—	—
RS	○	○	×	×

Remark: RS-SUP is only available in 4-pitch OL.

CL: "Connecting link"
OL: "Offset link"

○ : Usable □ : Allow for a reduction in kilowatt ratings
△ : Allow for a reduction in strength — : Manufacturing not possible × : Unusable ○ (dashed) : Made-to-order product

Roller Chain Selection

Other selections

Roller drive

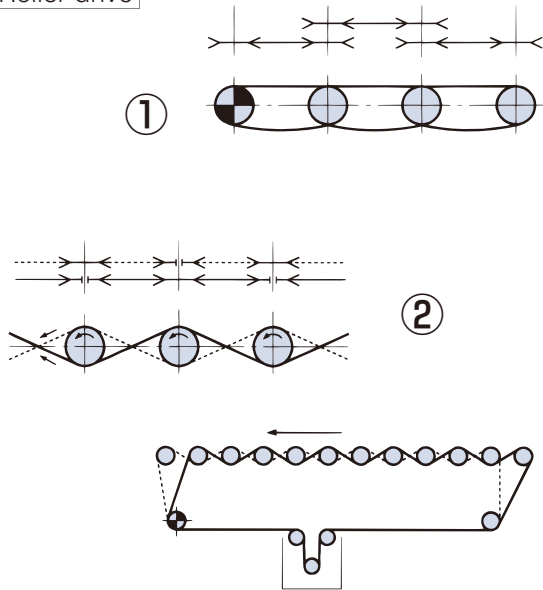

Multi-shaft drive

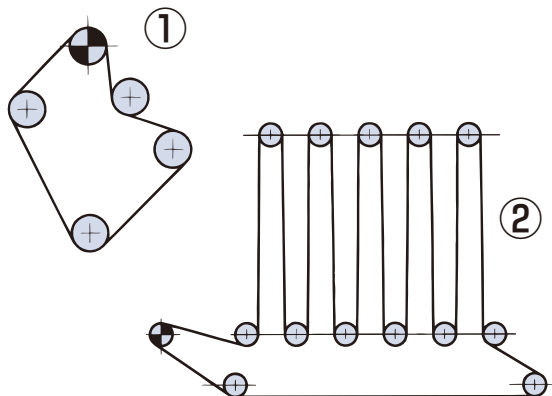

High-speed drive

Right side from peak of kW ratings tables (shaded area)

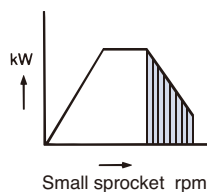

Vertical shaft drive

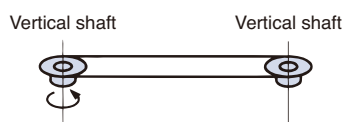

Required information for roller chain selection

- 1) Machine used
- 2) Type of impact
- 3) Motor type
- 4) Rated power of motor
- 5) Bore diameter of high-speed shaft and RPM
- 6) Bore diameter of low-speed shaft and RPM
- 7) Distance between shafts

Motor characteristics required for chain selection

When using the allowable load selection method or the pin gear drive selection method, check the following characteristics of the motor.

- 1) Moment of inertia of motor
- 2) Rated torque of motor, or motor shaft RPM
- 3) Starting torque of motor
- 4) Maximum (stalling) torque of motor
- 5) Motor braking torque

⚠ Safety precautions

The roller chain selection conditions provided here are only applicable to the selection of roller chain model and size. Please evaluate accessory devices such as safety and lubrication devices separately.

2. Service Factors

■ Multi-strand factor

The load borne by multi-strand roller chain is unequal across the width of the chain, and thus it cannot be expected that the transmission capacity will be equal to the capacity of a single-strand roller chain multiplied by the number of strands. For this reason, the transmission capacity of multi-strand roller chain is obtained by multiplying the transmission capacity of single-strand roller chain by a multi-strand factor.

Table 1: Multi-strand factor

Number of roller chain strands	Multi-strand factor
Double strand	1.7
Triple strand	2.5
Quadruple strand	3.3
Quintuple strand	3.9
Sextuple strand	4.6

■ Service factor Ks

The kW ratings are based on conditions of minimal load fluctuation. Depending on the degree of load fluctuation, it may be necessary to correct the kilowatt ratings using the service factor Ks.

Use Table 2 below to determine the appropriate service factor based on the type of machine and the source of power.

The design kW value is obtained by multiplying the kilowatt ratings by the service factor.

Table 2: Service factor Ks

Type of impact	Power source Example machines	Motor or Turbine	Internal combustion engine	
			With hydraulic drive	Without hydraulic drive
Smooth	Belt conveyors with little load fluctuation, chain conveyors, centrifugal pumps, centrifugal blowers, ordinary textile machines, and ordinary machines with little load fluctuation.	1.0	1.0	1.2
Moderate	Centrifugal compressors, marine engines, conveyors with moderate load fluctuation, automatic furnaces, dryers, pulverizers, general machine tools, compressors, general construction machines, general paper mill machines.	1.3	1.2	1.4
Large	Presses, crushers, construction and mining equipment, vibration machines, oil well rigs, rubber mixers, rolls, roll gangs, general machines with reverse or large-impact loads.	1.5	1.4	1.7

■ RPM factor Kn and teeth factor Kz

Table 3: RPM factor Kn and number of teeth factor Kz

RPM r/min	RPM factor Kn	Number of teeth	Teeth factor Kz
Less than 27	1.00	9 or more, less than 12	1.16
27 or more, less than 37	1.03	12 or more, less than 15	1.14
37 or more, less than 50	1.07	15 or more, less than 18	1.12
50 or more, less than 70	1.10	18 or more, less than 24	1.10
70 or more, less than 100	1.14	24 or more, less than 30	1.08
100 or more, less than 150	1.19	30 or more, less than 38	1.06
150 or more, less than 300	1.27	38 or more, less than 47	1.04
300 or more, less than 500	1.34	47 or more, less than 60	1.02
500 or more, less than 1000	1.44	60 or higher	1.00
1000 or more, less than 2000	1.54		
2000 or more, less than 4000	1.65		

■ Shock factor K

This coefficient is determined by the ratio of the converted moments of inertia between the prime mover and the load on the same shaft (ratio of I, GD^2), and the amount of backlash in the transmission device.

When the inertia ratio R is greater than 10, use $R = 10$. When the inertia ratio R is less than 0.2, use $R = 0.2$.

If I or GD^2 of the prime mover or load is unknown, use the value of R in Figure 1.

Figure 1: Shock factor K

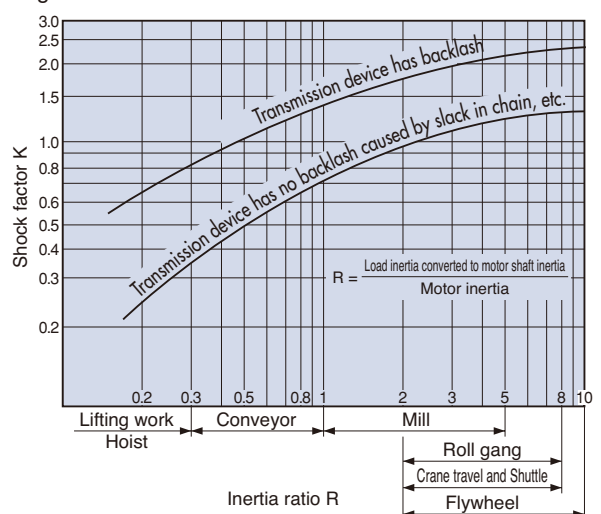

■ Imbalance load factor Ku

When using two or four chains for lifting or shuttle traction drive, the chain load will not be uniform. This must be accounted for by multiplying the following imbalance load coefficient Ku to adjust the left-and-right load imbalance.

Example: For four lifting strands, the imbalance load factor for one strand $K_u = 0.6 \times 0.6 = 0.36$

Table 4: Imbalance load factor Ku

2 lifting strands	0.6
4 lifting strands	0.36

Roller Chain Selection

3. Provisional Selection Graph

Figure 2: RS Standard Roller Chain Provisional Selection Graph

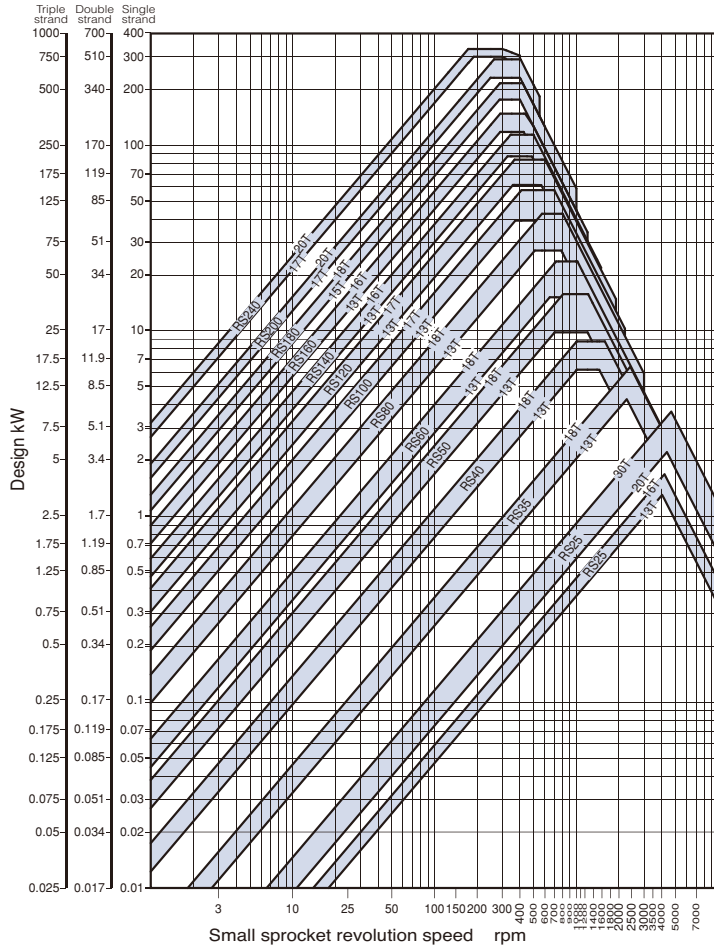

■ How to use this table (Fig. 2)

1. Example: Single-strand chain, design kW=7kW

(1) Assume that the speed of the small sprocket is 100 rpm. Judging from the intersecting point of design kW value of 7 kW (vertical axis) and the speed value of 100 rpm (horizontal axis), RS80 and a sprocket with between 13 and 18 teeth would be appropriate. Therefore, based on the position of the intersection, we can see that a 15T sprocket can be used.

(2) Assume that the speed of the small sprocket is 200 rpm. Following the same procedure shown in the above example, RS80 and a sprocket with less than 13 teeth or RS60 and a sprocket with more than 18 teeth would be appropriate. This table is used for tentative selections only. The kW ratings tables should be used to confirm the chain sizes.

(3) Please allow for a drop in the kW rating values shown in the design kW ratings chart (Fig.2) when 1-pitch offset links or Super 4POL are used.

Figure 3: RS-HT Roller Chain Provisional Selection Graph

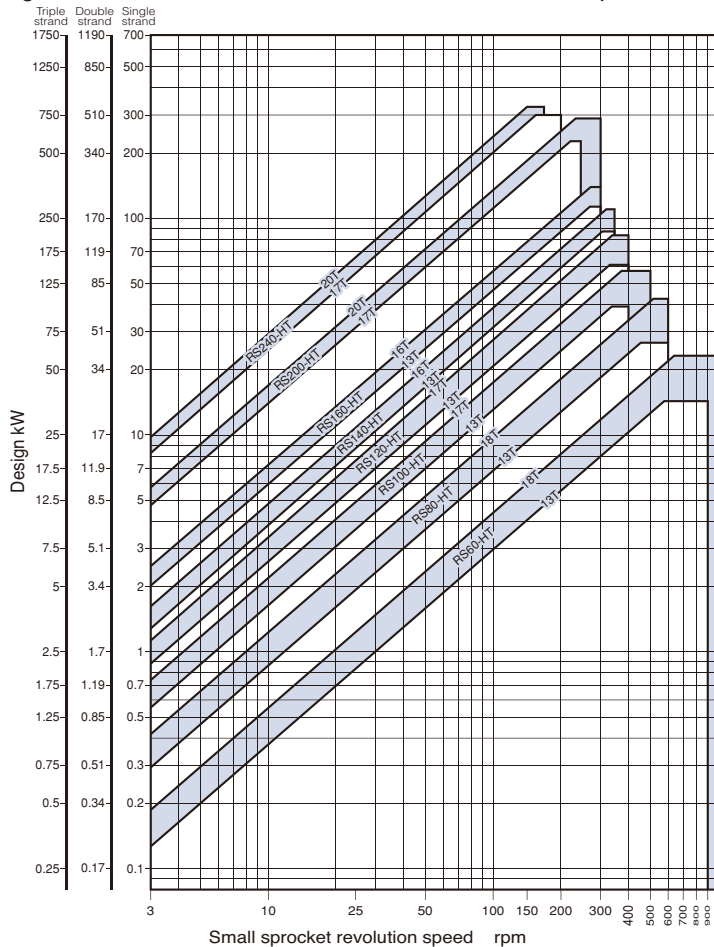

Before Use
 Standard Roller Chains
 Lubrication-Free Roller Chains
 Heavy Duty Roller Chains
 Corrosion Resistant Roller Chains
 Specialty Roller Chains
 Sprockets
 Pin Gear Drives
 Accessories
 Selection
 Handling

Figure 4: RS Super Roller Chain Provisional Selection Graph

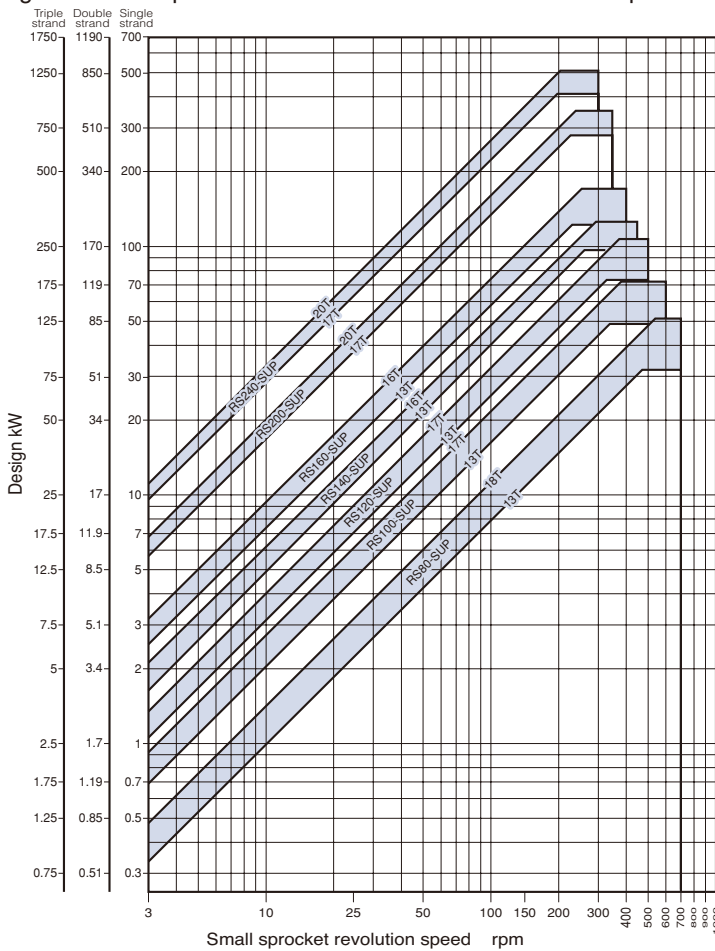
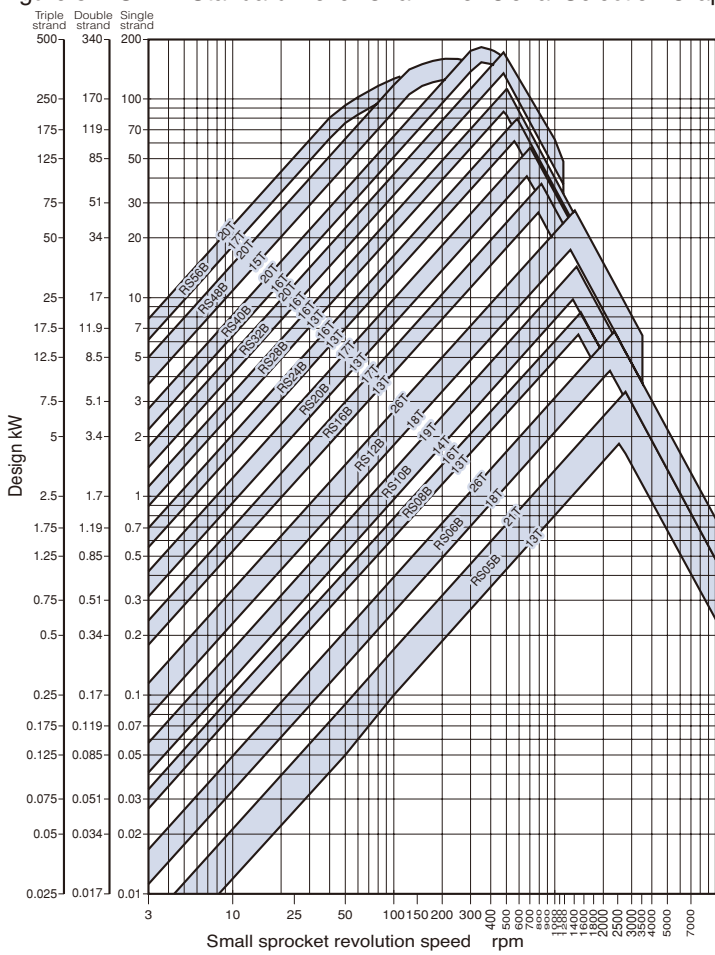

Figure 5: BS/DIN Standard Roller Chain Provisional Selection Graph



Roller Chain Selection

4. Selection Formulae

SI units and gravimetric units are both indicated

4-1 Symbols and units used in formulae (Table 5)

Symbol	Description	SI units	Gravimetric units
α_b	Load deceleration	m/s ²	m/s ²
α_s	Load acceleration	m/s ²	m/s ²
C	Center distance in pitches	—	—
C'	Center distance between shafts	m	m
d	Pitch circle diameter of the reducer output shaft sprocket	mm	mm
D	Outer diameter of the drum	mm	mm
F _b	Chain tension when decelerating	kN	kgf
F' _b	Design chain tension when decelerating	kN	kgf
F _c	Chain tension of shuttle drive	kN	kgf
F' _c	Design chain tension of shuttle drive	kN	kgf
F _ℓ	Chain tension from torque on load side (actual load)	kN	kgf
F' _ℓ	Design chain tension from torque on load side (actual load)	kN	kgf
F _m	Chain tension from prime mover rated output	kN	kgf
F' _m	Design chain tension from prime mover rated output	kN	kgf
F _{ms}	Chain tension from starting torque of prime mover	kN	kgf
F' _{ms}	Design chain tension from starting torque of prime mover	kN	kgf
F _{mb}	Chain tension from braking torque of prime mover	kN	kgf
F' _{mb}	Design chain tension from braking torque of prime mover	kN	kgf
F _s	Chain tension when accelerating	kN	kgf
F' _s	Design chain tension when accelerating	kN	kgf
F _w	Chain tension from load (actual load)	kN	kgf
F' _w	Design chain tension from load (actual load)	kN	kgf
f _i	Coefficient of friction between roller and rail (with lubrication 0.14, without lubrication 0.21)	—	—
G	Standard acceleration from gravity G = 9.80665 m/s ²	—	—
i	Speed ratio (example) if ratio is 1/30 than i = 30	—	—
I _ℓ {GD ² _ℓ }	Converted moment of inertia of the loaded prime mover shaft	kg·m ²	kgf·m ²
I _m {GD ² _m }	Moment of inertia of the prime mover shaft	kg·m ²	kgf·m ²
K	Shock factor	Refer Table 4	—
K _n	RPM factor	—	—
K _s	Service factor	Refer Table 2	—
K _u	Imbalance load factor	Refer Table 5	—
K _v	Speed factor	Refer Table 3	—
K _z	Number of teeth factor	—	—
L	Chain length (number of links)	—	—
m	Unit mass of chain	kg/m	kgf/m
M{W}	Mass of load (weight)	kg	kgf
n	RPM of the small sprocket	r/min	rpm
n ₁	RPM of driver shaft	r/min	rpm
n ₂	RPM of driven shaft	r/min	rpm
P	Chain pitch	mm	mm
R	Inertia ratio	Refer Table 4	—
S	Attachment height for RS attachment chain (distance from the drum surface to the chain pitch center)	mm	mm
t _b	Deceleration time	s	s
t _s	Acceleration time	s	s
T _b	Braking torque of the prime mover	%(kN·m)	%(kgf·m)
T _{max}	Maximum (stalling) torque of the prime mover	%(kN·m)	%(kgf·m)
T _s	Starting torque of the prime mover	%(kN·m)	%(kgf·m)
T _ℓ	Load torque	kN·m	kgf·m
T _m	Working torque	kN·m	kgf·m
T _n	Rated torque of the prime mover	kN·m	kgf·m
V	Chain speed	m/min	m/min
V _ℓ	Load speed	m/min	m/min
Z	Number of teeth of large sprocket	—	—
Z'	Number of teeth of small sprocket	—	—
ω	Angular velocity of the prime mover shaft	rad/min	rad/min
ω _b	Angular deceleration of the prime mover shaft	rad/s ²	rad/s ²
ω _s	Angular acceleration of the prime mover shaft	rad/s ²	rad/s ²

4-2 Formulae (Table 6)

- 1) Perform all selections using a transmission efficiency, including the chain, of $\eta = 1$.
- 2) Use the values calculated in items 13 and 14 of this table for the tension and kW ratings used for selection.

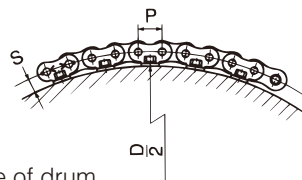
Item	SI units	Gravitational units
1. Chain length (number of links): L Ordinary transmission	<p>Ordinary transmission between two shafts</p> <p>(1) When the number of teeth and distance between shafts has been decided for both sprockets:</p> $L = \frac{Z + Z'}{2} + 2C + \frac{\left(\frac{Z - Z'}{6.28}\right)^2}{C}$ <p>(2) When the number of links of chain and the number of teeth has been decided:</p> $C = \frac{1}{8} \left\{ 2L - Z - Z' + \sqrt{(2L - Z - Z')^2 - \frac{8}{9.86}(Z - Z')^2} \right\}$ <p>Even if the fractional part of the value found for L (below that of the decimal point) is small, round it up to the nearest integer and add a link. An offset link must be used when an odd number of links exist. However, if possible, change the number of teeth on the sprocket or the distance between shafts so that an even number of links may be used.</p>	
Pin gear drive	<p>When using a chain with attachment around a drum</p> $L = \frac{180^\circ}{\tan^{-1}\left(\frac{P}{D + 2S}\right)}$ <p>P: Chain pitch D: Outer circumference of drum S: Height of attachment</p> 	<p>Round L up to an even number of links. When attaching the chain attachment around the drum, insert shims at equal intervals for adjustment.</p>
2. Chain speed: V	$V = \frac{P \times Z' \times n}{1000}$ (m/min)	
3. Chain tension from rated output (kW) and rated RPM of motor: Fm	$F_m = \frac{60 \times \text{kW}}{V}$ (kN)	$F_m = \frac{6120 \times \text{kW}}{V}$ (kgf)
4. Moment of inertia where the prime mover shaft converts the moment of inertia of the load I (GD ²) : I _ℓ (GD ² _ℓ)	$I_\ell = M \times \left(\frac{V}{2\pi n_1}\right)^2$ (kg·m ²)	$GD_\ell^2 = W \times \left(\frac{V}{\pi n_1}\right)^2$ (kgf·m ²)
5. Rated torque of motor: Tn	$T_n = 9.55 \times \frac{\text{kW}}{n_1}$ (kN·m)	$T_n = 974 \times \frac{\text{kW}}{n_1}$ (kgf·m)
6. Working torque: Tm	$T_m = \frac{T_s(\%) + T_{\text{max}}(\%)}{2 \times 100} \times T_n$ (kN·m) Or $T_m = \frac{T_s(\text{kN}\cdot\text{m}) + T_{\text{max}}(\text{kN}\cdot\text{m})}{2}$ (kN·m)	$T_m = \frac{T_s(\%) + T_{\text{max}}(\%)}{2 \times 100} \times T_n$ (kgf·m) Or $T_m = \frac{T_s(\text{kgf}\cdot\text{m}) + T_{\text{max}}(\text{kgf}\cdot\text{m})}{2}$ (kgf·m)
7. Chain tension from starting torque: Fms Chain tension from braking torque: Fmb	$F_{ms} = \frac{T_s(\%) \times i}{\{d/(2 \times 1000)\} \times 100} \times T_n \times 1$ (kN) Or $F_{ms} = \frac{T_s(\text{kN}\cdot\text{m}) \times i}{d/(2 \times 1000)} \times 1$ (kN) $F_{mb} = \frac{T_b(\%) \times i}{\{d/(2 \times 1000)\} \times 100} \times T_n \times 1.2^*$ (kN) Or $F_{mb} = \frac{T_b(\text{kN}\cdot\text{m}) \times i}{d/(2 \times 1000)} \times 1.2^*$ (kN) *: Constants	$F_{ms} = \frac{T_s(\%) \times i}{\{d/(2 \times 1000)\} \times 100} \times T_n \times 1$ (kgf·m) Or $F_{ms} = \frac{T_s(\text{kgf}\cdot\text{m}) \times i}{d/(2 \times 1000)} \times 1$ (kgf·m) $F_{mb} = \frac{T_b(\%) \times i}{\{d/(2 \times 1000)\} \times 100} \times T_n \times 1.2^*$ (kgf·m) Or $F_{mb} = \frac{T_b(\text{kgf}\cdot\text{m}) \times i}{d/(2 \times 1000)} \times 1.2^*$ (kgf·m) *: Constants
8. Acceleration time: ts If acceleration time is already known, use that.	$t_s = \frac{(I_m + I_\ell) \times n_1}{9550 \times (T_m - T_\ell)} \times (s)$	$t_s = \frac{(GD_m^2 + GD_\ell^2) \times n_1}{375 \times (T_m - T_\ell)} \quad (s)$
9. Deceleration time: tb If deceleration time is already known, use that. ± : When there is a negative load, such as a hanging load, use -T _ℓ .	$t_b = \frac{(I_m + I_\ell) \times n_1}{9550 \times (T_m \pm T_\ell)} \times (s)$	$t_b = \frac{(GD_m^2 + GD_\ell^2) \times n_1}{375 \times (T_m \pm T_\ell)} \quad (s)$

Roller Chain Selection

Item	SI units	Gravimetric units
10. Acceleration Linear motion: α_s Rotating motion: ω_s Assuming linear acceleration. In other situations, calculate using maximum acceleration.	Linear motion (load acceleration) Rotating motion (angular speed of motor shaft) Rotating motion (angular acceleration of motor shaft)	$a_s = \frac{V_\ell}{t_s \times 60}$ $\omega = 2\pi \times n_1$ $\omega_s = \frac{\omega}{t_s \times 60}$
11. Deceleration Linear motion: α_b Rotating motion: ω_b Assuming linear deceleration. In other situations, calculate using maximum acceleration.	Linear motion (load acceleration) Rotating motion (angular speed of motor shaft) Rotating motion (angular acceleration of motor shaft)	$a_b = \frac{V_\ell}{t_b \times 60}$ $\omega = 2\pi \times n_1$ $\omega_b = \frac{\omega}{t_b \times 60}$
12. Chain tension during acceleration: F_s Chain tension during deceleration: F_b	Linear motion $F_s = \frac{M \times a_s}{1000} + F_w$ Rotating motion $F_s = \frac{I_\ell \times \omega_s \times i}{1000 \times \left(\frac{d}{2 \times 1000}\right)} + F_w$ Linear motion $F_b = \frac{M \times a_b}{1000} + F_w$ Rotating motion $F_b = \frac{I_\ell \times \omega_b \times i}{1000 \times \left(\frac{d}{2 \times 1000}\right)} + F_w$	Linear motion $F_s = \frac{M \times a_s}{G} + F_w$ Rotating motion $F_s = \frac{GD^2_\ell / 4 \times \omega_s \times i}{\left(\frac{d}{2 \times 1000}\right) \times G} + F_w$ Linear motion $F_b = \frac{M \times a_b}{G} + F_w$ Rotating motion $F_b = \frac{GD^2_\ell / 4 \times \omega_b \times i}{\left(\frac{d}{2 \times 1000}\right) \times G} + F_w$
13. Design kW (for general selection)	Design kW = Rated kW of motor x K_s (kW)	
14. Design chain tension Design chain tension from motor: $F'm$ Design chain tension from starting torque: $F'm_s$ Design chain tension from stalling torque: $F'm_b$ Design chain tension from shuttle drive: $F'c$ Design chain tension during acceleration: $F's$ Design chain tension during deceleration: $F'b$ Design chain tension from load: $F'w$	$F'm = F_m \times K_s \times K_n \times K_z \quad (\text{kN } \{\text{kgf}\})$ $F'm_s = F_{m_s} \times K \times K_n \times K_z \quad (\text{kN } \{\text{kgf}\})$ $F'm_b = F_{m_b} \times K \times K_n \times K_z \quad (\text{kN } \{\text{kgf}\})$ $F'c = F_c \times K_s \times K_n \times K_z \quad (\text{kN } \{\text{kgf}\})$ $F's = F_s \times K_n \times K_z \quad (\text{kN } \{\text{kgf}\})$ $F'b = F_b \times K_n \times K_z \quad (\text{kN } \{\text{kgf}\})$	$F'w = W \text{ (Or } F_w) \times K_s \times K_n \times K_z \text{ (kgf)}$
	$F'w = M \times K_s \times K_n \times K_z \times \frac{G}{1000} \text{ (kN)}$	
	If the mass M (weight W) is not known, use the rated torque T_n of the motor to calculate the shaft torque $T = T_n \times i$ kN·m {kgf·m}, and use $F = 2T/d$ in place of W .	
15. Inertia ratio: R	$R = \frac{I_\ell}{I_m}$	$R = \frac{GD^2_\ell}{GD^2_m}$
16. Conversion of the flywheel effect (GD^2) to moment of inertia (I)	$1 \text{ kg} \cdot \text{m}^2 \dots (I)$	$4 \text{ kgf} \cdot \text{m}^2 \dots (GD^2)$

All chain tensions in the above formulae are the tensions when one strand of chain is used. When using two or more strands of chain, calculate the chain tension for one strand and multiply it by the imbalance load factor K_u (Table 4) for the number of strands used.

5. General Selection Method

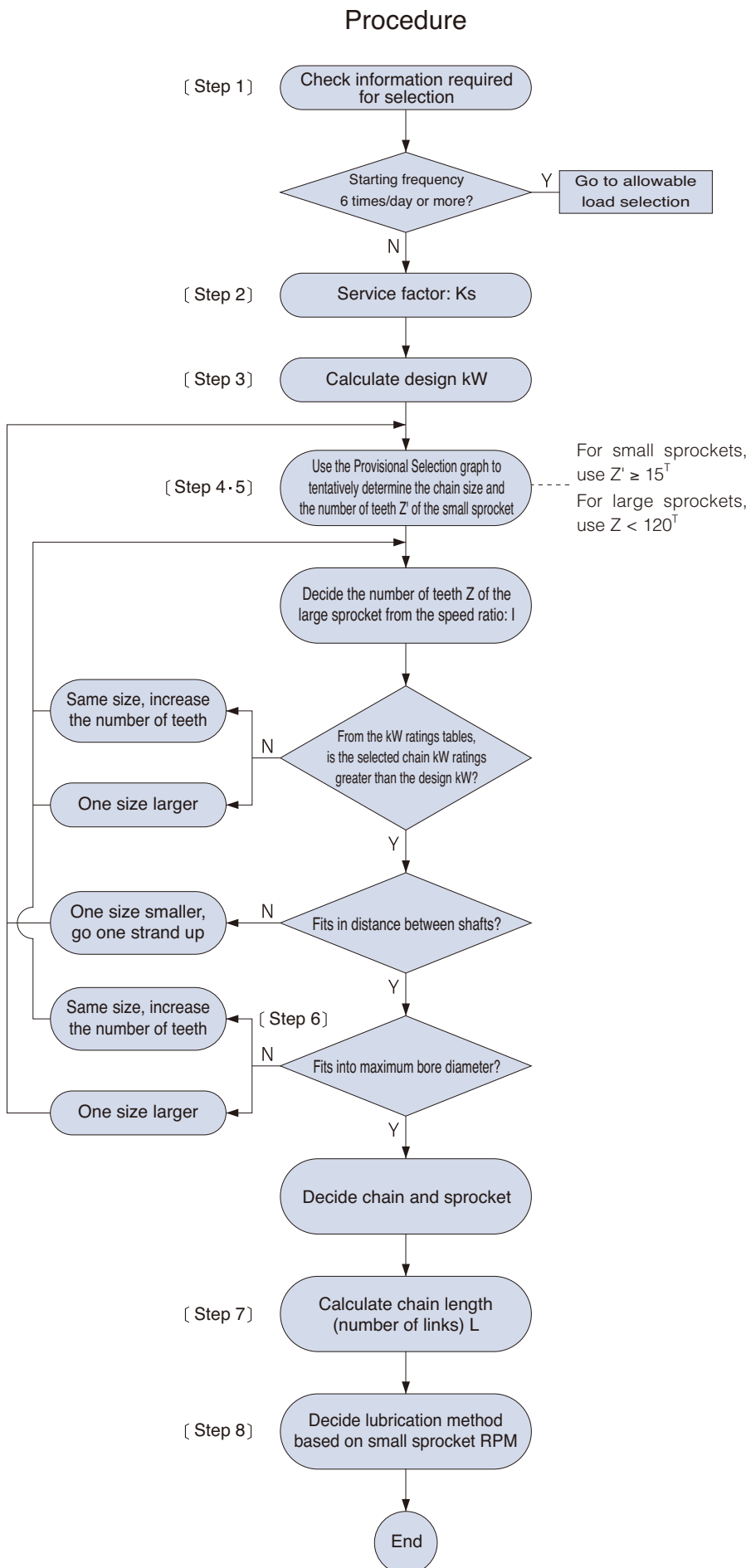

Ordinary transmission (forward / reverse), continual revolution transmission
Using kW ratings tables, infrequent start-up

Steps 4 and 5

(1) Select chain and number of teeth of small sprocket

Use the provisional selection graph (Fig. 2, 3 and 4) or the kW ratings tables to obtain a chain and small sprocket number of teeth that satisfy the revolution speed of the high-speed shaft and the transmission kW. Select a chain with the smallest pitch that has the required kW ratings.

If a single strand chain does not have sufficient power, select a multi-strand chain. If site restrictions require a short distance between shafts and the smallest possible sprocket outer diameter, use a multi-strand roller chain with a small pitch.

(2) Select number of teeth for large sprocket

Once the number of teeth of the small sprocket has been decided, the number of teeth of the large sprocket is determined by multiplying the number of teeth of the small sprocket by the speed ratio.

The number of teeth of the small sprocket should be at least 15. However, it is not desirable if this causes the number of teeth of the large sprocket to exceed 120. In this event, the number of teeth of the small sprocket must be reduced; however, it is recommended to use more than 13 teeth.

Step 7

When the number of links is odd

If the number of links is odd, it is best to avoid using an offset link and instead change the distance between shafts so that the number of links is even. If the one-pitch offset link of RS roller chain or the four-pitch offset link of Super chain is used, allow for a decrease of transmission power as explained in the notes in the kW ratings tables.

Roller Chain Selection

Selection example using the general selection method

(Step 1) Required data

Machine used	: Agitator
Type of shock	: Moderate shock
Source of power	: Motor
Rated power	: 11 kW 1800 rpm
High speed shaft	: Shaft diameter 45mm 90 rpm
Low speed shaft	: Shaft diameter 60mm 30 rpm
Distance between shafts	: 350 mm
Space limitation	: 700 mm

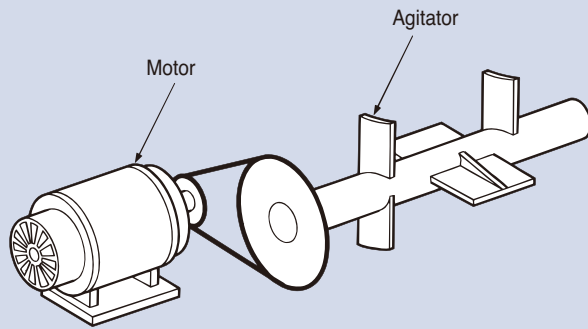

(Step 2) Determine the service factor

Service factor $K_s = 1.3$ from Table 2 Service Factor

(Step 3) Determine the design kW

Design kW = 11 kW X 1.3 = 14.3 kW

(Steps 4 and 5) Determine the chain and the number of teeth for the sprocket

Decide on the chain number and number of teeth of the small sprocket derived from the speed of the high speed shaft, at 90 rpm, and the design kW (14.3 kW).

(1) 17T for single strand RS100 is derived from the basic selection figure and the kilowatt ratings table. Since the speed ratio is 1/3, the number of teeth will be 17T and 51T for RS100. But, with an outer diameter of 17T at 189 mm and 51T at 534 mm, these are not adequate because they do not fit in the required space. $\therefore 189 + 534 > 700$

(2) Checking multi-strand chains:

- 19T and 57T for RS80-2 is derived with double-strand chain, and the outer diameter of its sprockets are 167 mm and 476 mm, which is within limits. Check RS80 kilowatt ratings table for the kW ratings of 19T for RS80-2.
- The kW ratings for the small sprocket number of teeth (19T) is 5.06 kW at 50 rpm, and 9.44 kW at 100 rpm. By calculating proportionally using the differences in their tables, drive kW for 90 rpm is 8.56 kW.

(3) This 8.56 kW is the kilowatt rating of single-strand chain, and the kilowatt rating of double-strand chain that will be used is derived from the multi-strand factor in Table 1.

$$8.56 \text{ kW} \times 1.7 = 14.6 \text{ kW}$$

(4) This kW rating, 14.6 kW, satisfies the design kW (14.3 kW).

(Step 6) Check the bore diameter

- (1) Check the bore diameter on the dimension table. Maximum bore diameter for RS80-2-19T is 63 mm, and it can be used for the required bore diameter of 45 mm. Maximum bore diameter for RS80-2-57T is 80 mm, and it can be used for the 60 mm.

(Step 7) Determine the distance between shafts

With a distance between shafts of 350 mm,

$$\frac{(167 + 476)}{2} < 350, \text{ and it will fit into the required space.}$$

Number of the links is calculated as

$$L = \frac{57 + 19}{2} + 2 \times \frac{350}{25.4} + \frac{\left(\frac{57 - 19}{2}\right)^2}{\frac{350}{25.4}} = 68.2$$

In order to have an even number of links, raise the value to the right of the decimal point to an integer to get 70.

(Step 8) Check lubrication method

Since the small sprocket is RS80-2-19T at a speed of 90 rpm, according to the kilowatt ratings table, lubrication method A will be used. It is necessary to use oil bath lubrication or lubrication with a slinger disc.

For selecting lifting or shuttle traction applications, do not use the General Selection method. Use the Allowable Load Selection method.

Reason: It is assumed that the braking force will be large when a balance weight is used, even if the motor capacity is small.

6. Allowable Load Selection Method

Procedures

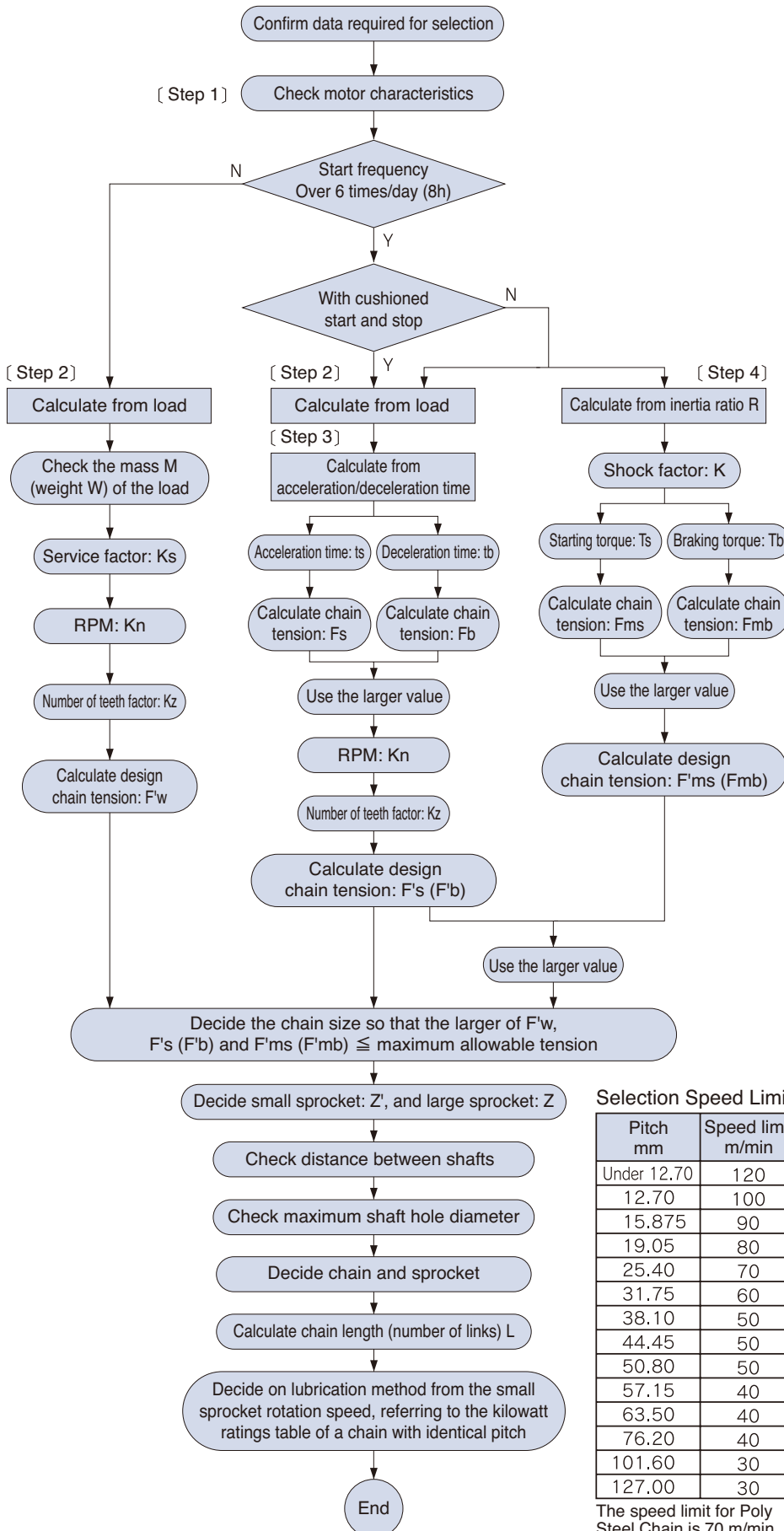

Selection Speed Limit

Pitch mm	Speed limit m/min
Under 12.70	120
12.70	100
15.875	90
19.05	80
25.40	70
31.75	60
38.10	50
44.45	50
50.80	50
57.15	40
63.50	40
76.20	40
101.60	30
127.00	30

The speed limit for Poly Steel Chain is 70 m/min.

The following selection method uses maximum allowable load for products with no kilowatt ratings tables, or for products operated at low speeds with frequent stops.

(1) For transmission with large shocks and other extreme conditions, in particular large-load transmission and transmission where a thrust load may operate, use F-type connecting links or two-pitch offset links.

(2) When using a one-pitch offset link, or a Super Chain 4 pitch offset link, make the following allowances for strength with respect to the maximum allowable load
 M-type CL*: 100%
 F-type CL: 100%
 Two-pitch offset link: 100% (Reference)
 One-pitch offset link: 65%
 4 pitch offset link: 85% (Super Chain single strand)
 One and two-pitch offset link: 60% (BS/DIN Chain)

(3) There is a possibility that the rim or boss of commercially available cast iron sprockets are not strong enough for the high tension of Super Chain, Super-H Roller Chain, and Ultra Super Chain. A type, B type, and C type RS sprockets are suitably strong. (Use SS400, S35C, SC450, etc.)

(4) For high-speed sprockets, use a sprocket with hardened tooth tips.

(5) Be sure to lubricate roller chain, as the bearing pressure rises very high.

* Allow an 80% reduction for M type connecting links for RS15, 25, 37, 38, 41, BF25-H, 05B, 06B, 48B, 56B and RS-KT Corrosion Resistant roller chain.

Roller Chain Selection

Sample selection using the allowable load selection method

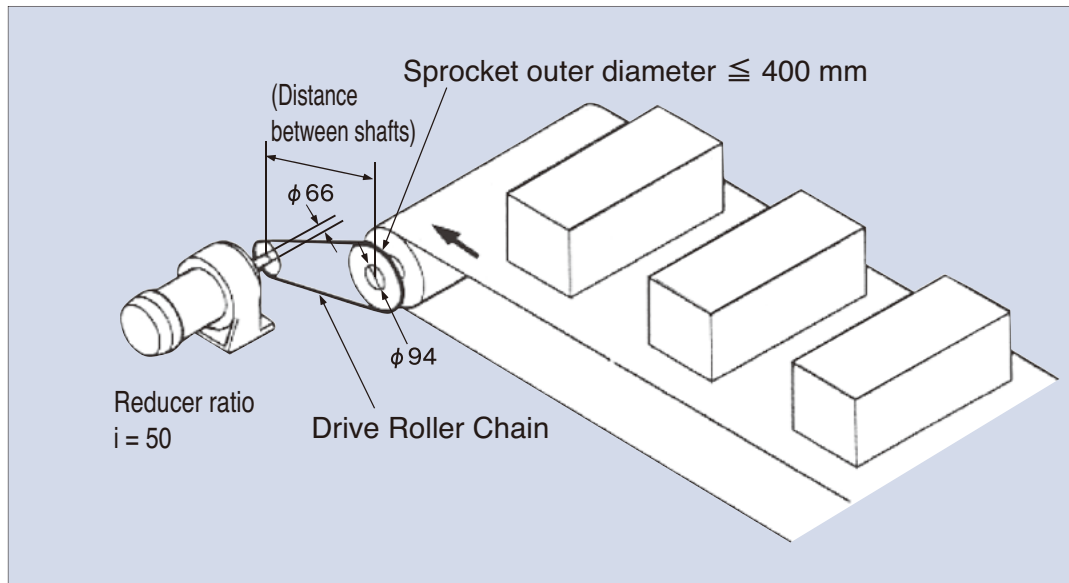

Conditions

Machine used: Conveyor drive
 Chain load M: 6000 kg
 Chain speed $V\ell$: 30 m/min
 Conveyor roller diameter: 380 mm
 Belt thickness: 10 mm
 Conveyor roller rotation torque: 3.3 kN/m (337 kg/m)
 Motor : 11 kW $n_1 = 1800$ rpm
 Starting torque T_s 200%
 Maximum (stalling) torque T_{max} 210%
 Braking torque T_b 200%

Moment of inertia I_m 0.088 kg/m²
 (flywheel effect GD^2 0.352 kgf/m²)
 Reducer ratio: 1/50 ($i = 50$)
 Drive shaft diameter: 66 mm
 Driven shaft diameter: 94 mm
 Distance b/w shafts: 500 mm
 Driven sprocket diameter ≤ 400 mm
 Starting frequency: 10 times/day
 Type of shock: Moderate shock
 Soft start/stop: None

SI Units

(Step 1) Check motor characteristics

Rated torque $T_n = 9.55 \times \frac{kW}{n_1} = 9.55 \times \frac{11}{1800} = 0.058$ (kN·m)
 Starting torque $T_s = T_n \times 2 = 0.058 \times 2 = 0.116$ (kN·m)
 Maximum (stalling) torque $T_{max} = T_n \times 2.1 = 0.058 \times 2.1 = 0.122$ (kN·m)
 Braking torque $T_b = T_n \times 2.0 = 0.058 \times 2.0 = 0.116$ (kN·m)
 Motor moment of inertia $I_m = 0.088$ (kg·m²)

(Step 2) Calculate from load

Driven shaft revolution
 $n_2 = V\ell \times \frac{1000}{(\text{External diameter of conveyor roller} + 2 \times \text{Belt thickness}) \times \pi}$
 $= 30 \times \frac{1000}{(380 + 20) \times \pi} = 23.9$ (r/min)
 Drive shaft revolution
 $n = n_1 / i = \frac{1800}{50} = 36$ (r/min)
 Chain reducer ratio $= \frac{23.9}{36} = \frac{1}{1.51}$
 If the driven sprocket PCD $d_2 = 400$ mm
 Chain tension $F_w = \text{Conveyor roller rotation torque} \times 1000 \times \frac{2}{d_2}$
 $= 3.3 \times 1000 \times \frac{2}{400} = 16.5$ (kN)

Tentatively select the chain.
 With moderate shock Usage factor $K_s = 1.3$
 Tentative design chain tension = $F_w \times K_s = 16.5 \times 1.3 = 21.5$ (kN)
 Tentatively select RS120-1 with a maximum allowable load of 30.4 kN.

{Gravimetric units}

(Step 1) Check motor characteristics

Rated torque $T_n = 9.74 \times \frac{kW}{n_1} = 9.74 \times \frac{11}{1800} = 5.95$ (kgf·m)
 Starting torque $T_s = T_n \times 2 = 5.95 \times 2 = 11.9$ (kgf·m)
 Maximum (stalling) torque $T_{max} = T_n \times 2.1 = 5.95 \times 2.1 = 12.5$ (kgf·m)
 Braking torque $T_b = T_n \times 2.0 = 5.95 \times 2.0 = 11.9$ (kgf·m)
 (kN/m) GD^2 of the motor $GD^2_m = 0.352$ (kgf·m²)

(Step 2) Calculate from load

Driven shaft revolution
 $n_2 = V\ell \times \frac{1000}{(\text{External diameter of conveyor roller} + 2 \times \text{Belt thickness}) \times \pi}$
 $= 30 \times \frac{1000}{(380 + 20) \times \pi} = 23.9$ (r/min)
 Drive shaft revolution
 $n = n_1 / i = \frac{1800}{50} = 36$ (r/min)
 Chain reducer ratio $= \frac{23.9}{36} = \frac{1}{1.51}$
 If the driven sprocket PCD $d_2 = 400$ mm
 Chain tension $F_w = \text{Conveyor roller rotation torque} \times 1000 \times \frac{2}{d_2}$
 $= 337 \times 1000 \times \frac{2}{400} = 1690$ (kgf)

Tentatively select the chain.
 With moderate shock Usage factor $K_s = 1.3$
 Tentative design chain tension = $F_w \times K_s = 1690 \times 1.3 = 2200$ (kgf)
 Tentatively select RS120-1 with a maximum allowable load of 3100 kgf.

Before Use Standard Roller Chains Lubrication Free Roller Chains Heavy Duty Roller Chains Corrosion Resistant Roller Chains Specialty Roller Chains Sprockets Pin Gear Drives Accessories Handling

31T from driven sprocket < 400mm
 Outer diameter 398 mm PCD d2=376.60 (mm)
 Number of teeth of drive sprocket = $\frac{31}{1.51}=21$ T PCD d1=255.63 (mm)
 Chain speed = $\frac{P \times Z' \times n}{1000} = \frac{38.1 \times 21 \times 36}{1000}$
 =28.8m/min < 50 m/min,

so it is possible to select by allowable load.
 Small sprocket revolution 36r/min · · · · RPM Kn=1.03
 Number of teeth of small sprocket 21T · · · · Number of teeth factor Kz=1.10

Chain tension Fw = Conveyor roller rotation torque × 1000 × $\frac{2}{d2}$
 = $3.3 \times 1000 \times \frac{2}{376.6} = 17.5$ (kN)

Design chain tension F'w=Fw × Ks × Kn × Kz
 = $17.5 \times 1.3 \times 1.03 \times 1.10 = 25.8$ (kN) ···①

RS120-1 (Max. allowable load: 30.4kN) can be used.
 Check the conveyance speed (selection conditions, 30 m/min)

$v\ell = n2 \times \frac{(\text{Conveyor roller external diameter} + 2 \times \text{Belt thickness}) \times \pi}{1000}$
 = $n1 \times \frac{21}{31} \times \frac{(\text{Conveyor roller external diameter} + 2 \times \text{Belt}) \times \pi}{1000}$
 = $36 \times \frac{21}{31} \times \frac{(380+2 \times 10) \times \pi}{1000}$
 =30.6 (m/min)

(Step 3) Calculate from acceleration/deceleration time

The small sprocket (reducer output shaft sprocket) was decided as RS120 21T from the calculations in step 2. Thus, calculate using the same pitch and number of teeth. If the acceleration/deceleration time is known, use that value for the calculation.
 The following is calculated assuming it is unknown.

Working torque $T_m = \frac{(T_s + T_{max})}{2} = \frac{(0.116 + 0.122)}{2} = 0.119$ (kN · m)

Load torque $T_\ell = F_w \times \frac{d}{(2 \times 1000 \times i)} = 17.5 \times \frac{255.63}{(2 \times 1000 \times 50)}$
 =0.045 (kN · m)

Motor shaft conversion moment of inertia I ℓ of load side
 $I_\ell = M \times \left(\frac{v\ell}{2 \times \pi \times n1} \right)^2$
 = $6000 \times \left(\frac{30.6}{2 \times \pi \times 1800} \right)^2$
 =0.044 (kg · m²)

Moment of inertia of the motor Im=0.088 (kg · m²)

Acceleration time of the motor
 $t_s = (I_m + I_\ell) \times \frac{n1}{9550 \times (T_m - T_\ell)}$
 = $(0.088 + 0.044) \times \frac{1800}{9550 \times (0.119 - 0.045)}$
 =0.34 (s)

Deceleration time of the motor
 $t_b = \frac{(I_m + I_\ell) \times n1}{9550 \times (T_b + T_\ell)}$
 = $\frac{(0.088 + 0.044) \times 1800}{9550 \times (0.119 + 0.045)}$
 =0.15 (s)

As t_b < t_s, chain tension during deceleration F_b is larger than chain tension during acceleration F_s. Thus, use the following.

Deceleration
 $a_b = \frac{v\ell}{t_b \times 60}$
 = $\frac{30.6}{0.15 \times 60}$
 = 3.40 (m/s²)
 $F_b = \frac{M \times a_b}{1000} \times \frac{(\text{Conveyor roller external diameter} + 2 \times \text{Belt thickness})}{d2} + F_w$
 = $\frac{6000 \times 3.40}{1000} \times \frac{(380 + 2 \times 10)}{376.6} + 17.5$
 =39.2 (kN)

31T from driven sprocket < 400mm
 Outer diameter 398 mm PCD d2=376.60 (mm)
 Number of teeth of drive sprocket = $\frac{31}{1.51}=21$ T PCD d1=255.63 (mm)
 Chain speed = $\frac{P \times Z' \times n}{1000} = \frac{38.1 \times 21 \times 36}{1000}$
 =28.8m/min < 50 m/min,

so it is possible to select by allowable load.
 Small sprocket revolution 36r/min · · · · RPM Kn=1.03
 Number of teeth of small sprocket 21T · · · · Number of teeth factor Kz=1.10

Chain tension Fw=Conveyor roller rotation torque × 1000 × $\frac{2}{d2}$
 = $337 \times 1000 \times \frac{2}{376.6} = 1790$ (kgf)

Design chain tension F'w=Fw × Ks × Kn × Kz
 = $1790 \times 1.3 \times 1.03 \times 1.10 = 2640$ (kgf) ···①

RS120-1 (Max. allowable load: 3100kgf) can be used.
 Check the conveyance speed (selection condition 30s, m/min)

$v\ell = n2 \times \frac{(\text{Conveyor roller external diameter} + 2 \times \text{Belt thickness}) \times \pi}{1000}$
 = $n1 \times \frac{21}{31} \times \frac{(\text{Conveyor roller external diameter} + 2 \times \text{Belt}) \times \pi}{1000}$
 = $36 \times \frac{21}{31} \times \frac{(380+2 \times 10) \times \pi}{1000}$
 =30.6 (m/min)

(Step 3) Calculate from acceleration/deceleration time

The small sprocket (reducer output shaft sprocket) was decided as RS120 21T from the calculations in step 2. Thus, calculate using the same pitch and number of teeth. If the acceleration/deceleration time is known, use that value for the calculation.
 The following is calculated assuming it is unknown.

Working torque $T_m = \frac{(T_s + T_{max})}{2} = \frac{(11.9 + 12.5)}{2} = 12.2$ (kgf · m)

Load torque $T_\ell = F_w \times \frac{d}{(2 \times 1000 \times i)} = 1790 \times \frac{255.63}{(2 \times 1000 \times 50)}$
 =4.58 (kgf · m)

Motor shaft conversion GD² of the load side
 $GD^2_\ell = M \times \left(\frac{v\ell}{\pi \times n1} \right)^2$
 = $6000 \times \left(\frac{30.6}{\pi \times 1800} \right)^2$
 =0.176 (kgf · m²)

GD² of the motor GD²m=0.352 (kgf · m²)

Acceleration time of the motor
 $t_s = (GD^2_m + GD^2_\ell) \times \frac{n1}{375 \times (T_m - T_\ell)}$
 = $(0.352 + 0.176) \times \frac{1800}{375 \times (12.2 - 4.58)}$
 =0.34 (s)

Deceleration time of the motor
 $t_b = \frac{(GD^2_m + GD^2_\ell) \times n1}{375 \times (T_b + T_\ell)}$
 = $\frac{(0.352 + 0.176) \times 1800}{375 \times (12.2 + 4.58)}$
 =0.34 (s)

As t_b < t_s, chain tension during deceleration F_b is larger than chain tension during acceleration F_s. Thus, use the following.

Deceleration
 $a_b = \frac{v\ell}{t_b \times 60}$
 = $\frac{30.6}{0.15 \times 60}$
 = 3.40 (m/s²)
 $F_b = \frac{M \times a_b}{G} \times \frac{(\text{Conveyor roller external diameter} + 2 \times \text{Belt thickness})}{d2} + F_w$
 = $\frac{6000 \times 3.40}{G} \times \frac{(380 + 2 \times 10)}{376.6} + 1790$
 =4000 (kgf)

Roller Chain Selection

Design chain tension

$$F'b = F_b \times K_n \times K_z = 39.2 \times 1.03 \times 1.10 = 44.4 \text{ (kN)} \dots \textcircled{2}$$

RS120-2 (maximum allowable load 51.7 kN) or RS120-SUP-2 (maximum allowable load 66.7 kN) can be used because $F'b = 44.4 \text{ (kN)}$.

Considering RS140 18T (outer diameter 279 mm $d_1 = 255.98$) and 27T (outer diameter 407 mm $d_2 = 382.88$) with similar PCD results conflict with the driven sprocket external diameter ≤ 400 mm, they cannot be used.

Chain reduction ratio becomes $\frac{36}{23.9}$ from the required $\frac{26}{18}$, and conveyance speed $= 30 \times \frac{36}{23.9} \times \frac{18}{26} = 31.3 \text{ m/min}$,

but upon examination 26T (outer diameter 393mm $d_2 = 368.77$)

$\textcircled{2}$ is $F'b = 46.3 \text{ (kN)}$

RS140-1 cannot be used because its maximum allowable load is 40.2kN. RS140-SUP-1 can be used because its maximum allowable load is 53.9kN. Since the sprocket bore diameter of 18T is up to 89 mm, and for 26T is up to 103 mm, it can be used with a drive shaft diameter of 66 mm and driven shaft diameter of 94 mm.

With the distance between shafts at 500 mm, a sprocket with 18T ($d_1 = 255.98$) and 26T ($d_2 = 368.77$) can be used.

Number of links will be 46 links.

Lubrication for RS140-SUP-1 should be oil bath or lubrication using a slinger disc as per the kilowatt ratings table.

(Step 4) Calculate from inertia ratio R

$$\text{Inertia ratio } R = \frac{I \ell}{I_m} = \frac{0.044}{0.088} = 0.5$$

There is clearance in the drive equipment \dots Shock factor $K = 1.0$

Starting torque $T_s = 0.116 \text{ (kN} \cdot \text{m)}$

Chain tension from starting torque

$$F_{ms} = T_s \times i \times 1000 \times \frac{2}{d} = 0.116 \times 50 \times 1000 \times \frac{2}{255.63} = 45.4 \text{ (kN)}$$

Braking torque $T_b = 0.116 \text{ (kN} \cdot \text{m)}$

Chain tension from braking torque

$$F_{mb} = T_b \times i \times 1.2 \times 1000 \times \frac{2}{d} = 0.116 \times 50 \times 1.2 \times 1000 \times \frac{2}{255.63} = 54.5 \text{ (kN)}$$

Since $F_{mb} > F_{ms}$, use the larger F_{mb} .

Design chain tension

$$F'm_b = F_{mb} \times K \times K_n \times K_z = 54.5 \times 1.0 \times 1.03 \times 1.10 = 61.7 \text{ (kN)} \dots \textcircled{3}$$

Comparing $\textcircled{1}$, $\textcircled{2}$, and $\textcircled{3}$, $\textcircled{3}$ is the largest.

Since $F'm_b = 61.7 \text{ (kN)}$, RS120-3 (maximum allowable load 76.0 kN) or RS120-SUP-2 (maximum allowable load 66.7 kN) is usable.

With the distance between shafts at 500mm, a sprocket with 21T ($d_1 = 255.63$) and 31T ($d_2 = 376.60$) can be used.

Number of links will be 54 links.

Lubrication for both RS120-1 and RS120-SUP-1 should be oil bath or lubrication by slinger disc as per the kilowatt ratings table.

Design chain tension

$$F'b = F_b \times K_n \times K_z = 4000 \times 1.03 \times 1.10 = 4530 \text{ (kgf)} \dots \textcircled{2}$$

RS120-2 (maximum allowable load 5270 kgf) or RS120-SUP-2 (maximum allowable load 6800kgN) can be used because $F'b = 4530 \text{ (kgf)}$.

Considering RS140 18T (outer diameter 279 mm $d_1 = 255.98$) and 27T (outer diameter 407 mm $d_2 = 382.88$) with similar PCD results conflict with the driven sprocket external diameter ≤ 400 mm, they cannot be used.

Chain reduction ratio becomes $\frac{36}{23.9}$ from the required $\frac{26}{18}$, and conveyance speed $= 30 \times \frac{36}{23.9} \times \frac{18}{26} = 31.3 \text{ m/min}$,

but upon examination 26T (outer diameter 393mm $d_2 = 368.77$)

$\textcircled{2}$ is $F'b = 4720 \text{ (kgf)}$

RS140-1 cannot be used because its maximum allowable load is 4100kgf. RS140-SUP-1 can be used because its maximum allowable load is 5500kgf. Since the sprocket bore diameter of 18T is up to 89 mm, and for 26T is up to 103 mm, it can be used with a drive shaft diameter of 66 mm and driven shaft diameter of 94 mm.

With the distance between shafts at 500 mm, a sprocket with 18T ($d_1 = 255.98$) and 26T ($d_2 = 368.77$) can be used.

Number of links will be 46 links.

Lubrication for RS140-SUP-1 should be oil bath or lubrication using a slinger disc as per the kilowatt ratings table.

(Step 4) Calculate from inertia ratio R

$$\text{Inertia ratio } R = \frac{GD^2 \ell}{GD_m^2} = \frac{0.176}{0.352} = 0.5$$

There is clearance in the drive equipment \dots Shock factor $K = 1.0$

Starting torque $T_s = 11.9 \text{ (kgf} \cdot \text{m)}$

Chain tension from starting torque

$$F_{ms} = T_s \times i \times 1000 \times \frac{2}{d} = 11.9 \times 50 \times 1000 \times \frac{2}{255.63} = 4660 \text{ (kgf)}$$

Braking torque $T_b = 11.9 \text{ (kgf} \cdot \text{m)}$

Chain tension from braking torque

$$F_{mb} = T_b \times i \times 1.2 \times 1000 \times \frac{2}{d} = 11.9 \times 50 \times 1.2 \times 1000 \times \frac{2}{255.63} = 5590 \text{ (kgf)}$$

Since $F_{mb} > F_{ms}$, use the larger F_{mb} .

Design chain tension

$$F'm_b = F_{mb} \times K \times K_n \times K_z = 5590 \times 1.0 \times 1.03 \times 1.10 = 6330 \text{ (kgf)} \dots \textcircled{3}$$

Comparing $\textcircled{1}$, $\textcircled{2}$, and $\textcircled{3}$, $\textcircled{3}$ is the largest.

Since $F'm_b = 6330 \text{ (kgf)}$, RS120-3 (maximum allowable load 7750 kgf) or RS120-SUP-2 (maximum allowable load 6800 kgf) is usable.

With the distance between shafts at 500mm, a sprocket with 21T ($d_1 = 255.63$) and 31T ($d_2 = 376.60$) can be used.

Number of links will be 54 links.

Lubrication for both RS120-1 and RS120-SUP-1 should be oil bath or lubrication by slinger disc as per the kilowatt ratings table.

Considering RS160 15T (outer diameter 269mm d1=244.33) and 23T (outer diameter 400mm d2=373.07) with similar PCD,

③ $F_{mb}=64.6(kN)$ will be largest.

RS160-1 cannot be used because its maximum allowable load is 53.0 kN. RS160-SUP-1 can be used because its maximum allowable load is 70.6kN. Since a sprocket bore diameter with 15T is up to 95mm, and 23T is up to 118mm, it can be used for a drive shaft diameter of 66mm, and driven shaft diameter of 94mm.

With the distance between shafts at 500mm, a sprocket with 15T (d1=244.33) and 23T (d2=373.07) can be used.

Number of links will be 42 links.

Lubrication for RS140-SUP-1 should be oil bath or lubrication by slinger disc as per kilowatt ratings table.

Considering RS160 15T (outer diameter 269mm d1=244.33) and 23T (outer diameter 400mm d2=373.07) with similar PCD,

③ $F_{mb}=6620(kgf)$ will be largest.

RS160-1 cannot be used because its maximum allowable load is 5400kgf. RS160-SUP-1 can be used because its maximum allowable load is 7200kgf. Since a sprocket bore diameter with 15T is up to 95mm, and 23T is up to 118mm, it can be used for a drive shaft diameter of 66mm, and driven shaft diameter of 94mm.

With the distance between shafts at 500mm, a sprocket with 15T (d1=244.33) and 23T (d2=373.07) can be used.

Number of links will be 42 links.

Lubrication for RS140-SUP-1 should be oil bath or lubrication by slinger disc as per kilowatt ratings table.

Measurement results

Condition	Step	Chain size	Sprocket	Number of links	Lubrication class
Start frequency 6 times or less	Step 2	RS120-1	21T×31T	54 links	B
Start frequency 6 times or more with cushion start	Step 3	RS120-2	21T×31T	54 links	B
		RS140-1	18T×26T	46 links	B
Start frequency 6 times or more without cushion start	Step 3	RS120-3	21T×31T	54 links	B
		RS120-SUP-2			B
	Step 4	RS160-SUP-1	15T×23T	42 links	B

Lubrication class B: Lubrication with oil bath or slinger disc
All shaft distances need to be adjusted.

Roller Chain Selection

7. Example of lifting transmissions

There are many examples of where chain is used for lifting. By making use of Roller Chain features, choosing the right chain and following some important points, it is possible to use Roller Chain for lifting transmissions. Typical lifting applications are illustrated below. (Please give special consideration to safety devices.)

Balancing

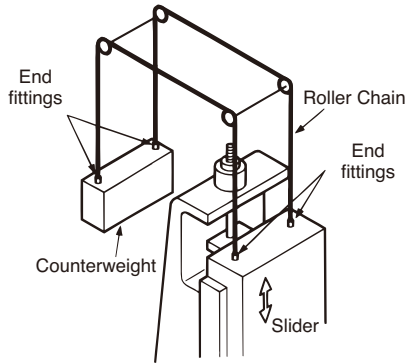

Lifting equipment (1)

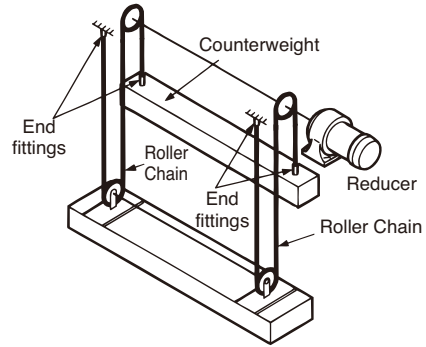

Lifting equipment (2)

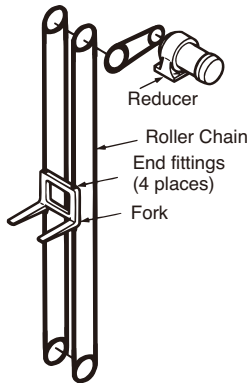

Lifting equipment (3)

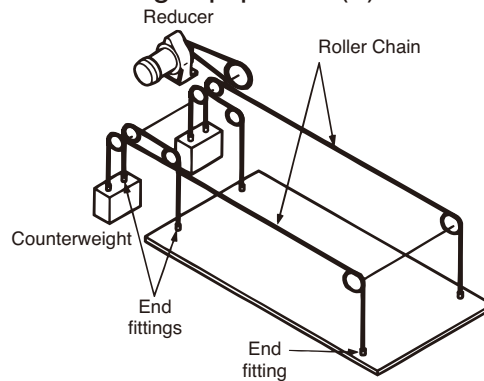

⚠ Selecting hanging roller chain

- ① If there are any laws or guidelines for chain selection, check and calculate accordingly. Make sure to follow the manufacturer's selections and select the safer of the two selections.
- ② Use F-type (semi press-fit) connecting links. Offset links cannot be used.
- ③ Lubricate the chain joints as much as possible after you reduce the loads. Sufficient lubrication is also required at end fittings (end bolts and connecting links, etc.) and connecting parts, etc.

Weight required for counterweight to prevent sprocket tooth-jumping when using Roller Chain in lifting transmission applications

$$T_k = T_o \times \left\{ \frac{\sin \phi}{\sin (\phi + 2\alpha)} \right\}^{K-1}$$

T_k : Minimum weight tension (minimum back-tension)

T_o : Roller Chain tension

ϕ : Sprocket minimum pressure angle $\phi = 17^\circ - \frac{64^\circ}{N}$

2α : Sprocket dividing angle $2\alpha = \frac{360^\circ}{N}$

K : Engaging no. of teeth $K = \frac{\theta}{360^\circ} \times N \dots$ Round up to the nearest whole number to be safe.

If $t_o = 1100\text{kgf}$, $N = 13$, and $\theta = 120^\circ$, then

$$\phi = 17^\circ - \frac{64^\circ}{N} = 17^\circ - \frac{64^\circ}{13} = 12.077$$

$$2\alpha = \frac{360^\circ}{N} = \frac{360^\circ}{13} = 27.692$$

$$K = \frac{\theta}{360^\circ} \times N = \frac{120^\circ}{360^\circ} \times 13 = 4.33 \dots K = 4$$

$$T_k = 1100 \times \left\{ \frac{\sin 12.077}{\sin (12.077 + 27.692)} \right\}^{4-1} = 38.5 \text{ (kg)}$$

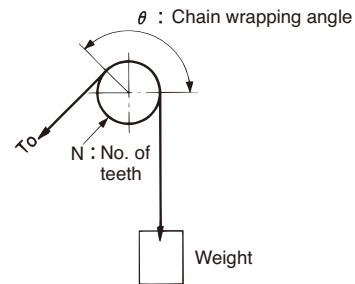

Accordingly, tooth-jumping will not occur if a 39 kg weight is used. However, this will change depending on the layout and amount of wear on the Roller Chain and sprocket teeth. Please use the above as a reference.

Roller Chain Selection

8. Calculating moment of inertia (Table 6)

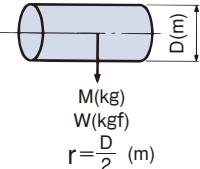
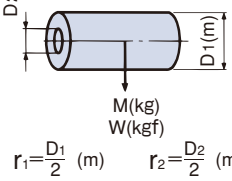
Rotating Body	(Moment of inertia) Calculation Method (SI Unit)	{ GD ² Calculation Method (Gravimetric Unit) }
<p>Right cylinder</p>  <p>$M(\text{kg})$ $W(\text{kgf})$ $r = \frac{D}{2} (\text{m})$</p>	$I = \frac{1}{2} Mr^2$ <p>(kg · m²)</p>	$GD^2 = \frac{1}{2} WD^2$ <p>(kgf · m²)</p>
<p>Hollow right cylinder</p>  <p>$M(\text{kg})$ $W(\text{kgf})$ $r_1 = \frac{D_1}{2} (\text{m})$ $r_2 = \frac{D_2}{2} (\text{m})$</p>	$I = \frac{1}{2} M(r_1^2 + r_2^2)$ <p>(kg · m²)</p>	$GD^2 = \frac{1}{2} W(D_1^2 + D_2^2)$ <p>(kgf · m²)</p>
Note		
	SI unit	{Gravimetric unit}
Moment of inertia (I) and fly wheel effect (GD ²)	1 kg · m ² (I)	4 kgf · m ² (GD ²)

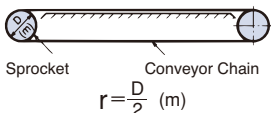
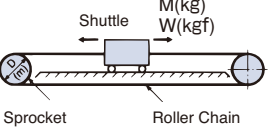
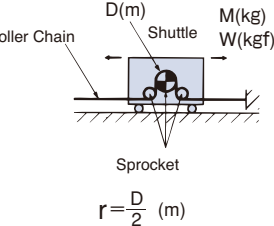
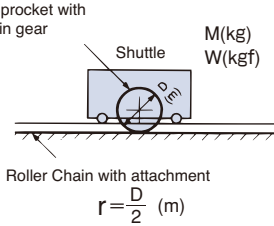
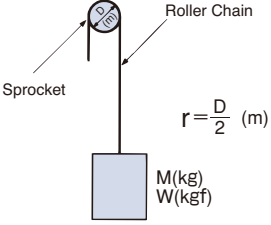
Linear Body	(Moment of inertia) Calculation Method (SI Unit)	{ GD ² Calculation Method (Gravimetric Unit) }
<p>Chain</p> <p>$M(\text{kg})$ $M = \frac{mL}{1000} \text{ kg}$ $W(\text{kgf})$ $W = \frac{mL}{1000} \text{ kgf}$</p>  <p>$r = \frac{D}{2} (\text{m})$</p>	$I = Mr^2 (\text{kg} \cdot \text{m}^2)$	$GD^2 = WD^2 (\text{kgf} \cdot \text{m}^2)$
<p>Shuttle Traction</p>  <p>$M(\text{kg})$ $W(\text{kgf})$ $r = \frac{D}{2} (\text{m})$</p>	$I = Mr^2 (\text{kg} \cdot \text{m}^2)$	$GD^2 = WD^2 (\text{kgf} \cdot \text{m}^2)$
 <p>$M(\text{kg})$ $W(\text{kgf})$ $r = \frac{D}{2} (\text{m})$</p>	$I = Mr^2 (\text{kg} \cdot \text{m}^2)$	$GD^2 = WD^2 (\text{kgf} \cdot \text{m}^2)$
<p>Pin gear drive</p>  <p>$M(\text{kg})$ $W(\text{kgf})$ $r = \frac{D}{2} (\text{m})$</p>	$I = Mr^2 (\text{kg} \cdot \text{m}^2)$	$GD^2 = WD^2 (\text{kgf} \cdot \text{m}^2)$
<p>Lifting application</p>  <p>$M(\text{kg})$ $W(\text{kgf})$ $r = \frac{D}{2} (\text{m})$</p>	$I = Mr^2 (\text{kg} \cdot \text{m}^2)$	$GD^2 = WD^2 (\text{kgf} \cdot \text{m}^2)$
<p>To convert moment of inertia load to motor shaft</p> <p>n_1: Motor shaft rotating speed n_2: Load shaft rotating speed</p>	$I \ell = \left(\frac{n_2}{n_1} \right)^2 I$ $= \frac{I}{i^2} (\text{kg} \cdot \text{m}^2)$ $I \ell = M \left(\frac{V}{2\pi n_1} \right)^2$ <p>(kg · m²)</p>	<p>Moment of inertia GD² load</p> $GD^2 \ell = \left(\frac{n_2}{n_1} \right)^2 GD^2$ $= \frac{GD^2}{i^2} (\text{kgf} \cdot \text{m}^2)$ $GD^2 \ell = W \left(\frac{V}{\pi n_1} \right)^2$ <p>(kgf · m²)</p>

The above does not include the mass of the sprocket and chain.

9. Example of shuttle traction

The following are typical examples of using Roller Chain for shuttle traction. The roller chain can be attached to the shuttle with an end fitting and towed using a sprocket on one end (left figure), or the driving unit can be attached to the shuttle, with a roller chain fixed to both ends using end fittings (right figure).

There are similar ways to tow a shuttle at an angle. With the left figure the drive sprocket would be set at the top of the incline.

⊕ : Drive side

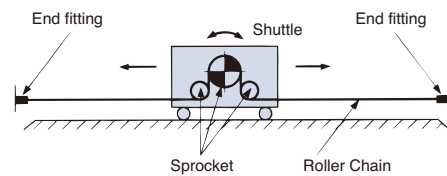
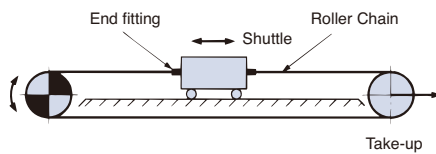

⚠ Selecting roller chain for shuttle traction

- ① If there are any laws or guidelines for chain selection, check and calculate accordingly. Make sure to follow the manufacturer's selections and select the safer of the two selections.
- ② Use F-Type (semi press-fit) connecting links. M-Type connecting links can only be used if there is minimal shock with no lateral force. Offset links cannot be used.
- ③ Lubricate the chain joints as much as possible after you reduce the loads. Sufficient lubrication is also required at end fittings (end bolts and connecting links, etc.) and connecting parts, etc.

Roller Chain Selection

10. Chain type pin gear drive selection method

Generally, linear movement or large radius rotation is made possible by a roller chain and gear through a transmission source (motor, etc.) via a reducer.

A roller chain, however, needs a lot of space, and gears require precision machining, which increases the cost. A pin gear is ideal in these situations.

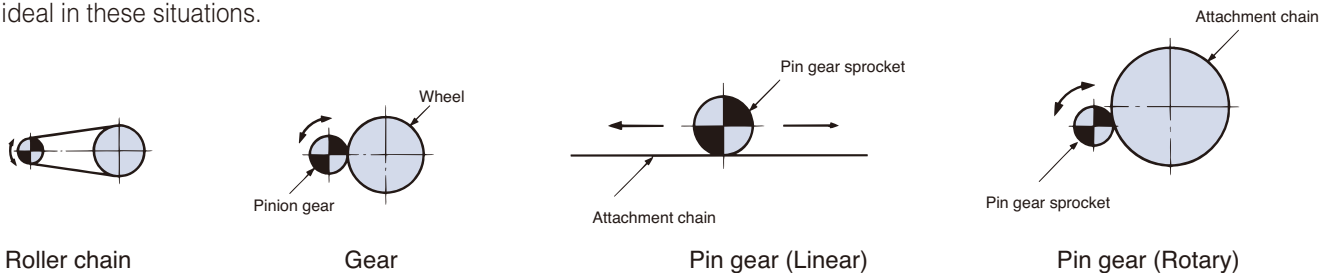

For pin gear drives, a roller chain is wrapped around the perimeter of a drum to make a wheel, and special sprockets (see Sprockets) are used instead of pinion gears. For linear motion, a roller chain is attached and used linearly instead of a rack.

Item	Pin gear drive	Roller chain transmission	Gear transmission
Restrictions on distance between shafts	Yes	No	Yes
Number of engaged teeth	Low	High	Low
Speed ratio range	No limit	Up to 1:7	No limit
Tooth shape	Special teeth	Sprocket teeth	Involute
Engagement accuracy	Normal	Normal	Precise

10.1 Characteristics of pin gears

- 1) Economical at large speed ratios (1:5 or larger), especially when the drum has a large diameter.
 - 2) Roller chain attachments are bolted onto the drum for easy installation and maintenance.
 - 3) Design freedom in drum diameter, linear length, etc.
 - 4) Rough installation accuracy and no precision machining required for gears.
 - 5) Grease lubrication can be used.
- ▲ A pin gear is not suitable for ultra precise drives, and the noise level is high compared to gears.

10.2 Chain installation and precautions

- 1) When used linearly (rack) with rollers facing up:
 - Use standard roller chain.

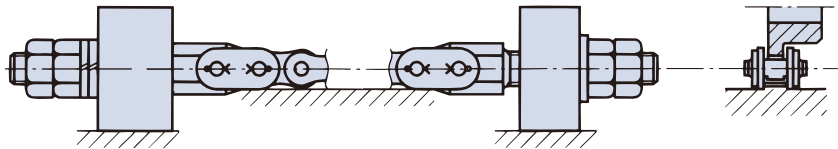

Connecting links are used on both ends, and fittings are attached and bolts and nuts are fastened to remove any slack. (Both ends need to be secured snugly with double nuts.) Note: This is not recommended as tooth slipping and interference can occur. Note: Do not use a rail for the rollers, as the teeth of the pin gear sprocket may interfere with the rail.

- Use an attachment roller chain.

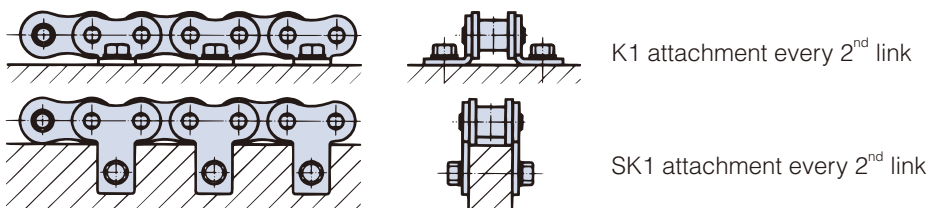

Attach K1 or SK1 attachments every 2nd link and fasten with bolts and nuts every 2nd or 4th link with chain pulled taut so there is no slack or meandering. (K attachments are recommended.) The attachment holes are usually processed on-site.

Note: Do not use a rail for the rollers when using SK1 attachments, as the teeth of the pin gear sprocket may interfere with the rail.

Use bolts with a strength class 8.8 or higher (JIS1051-2000, tensile strength 800 N/mm² or higher). (SCM435 heat treated bolts, etc.)

- The length of the chain should be the travel distance plus α .
 α : The distance of overrun based on usage conditions.

2) When used linearly (rack) with rollers facing down:

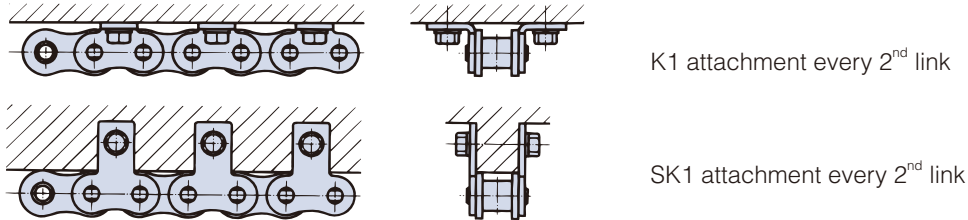

Attach K1 or SK1 attachments every 2nd link and fasten with bolts and nuts every 2nd or 4th link with chain pulled taut so there is no slack or meandering.

Note: When using SK1 attachments, be sure the rack touches the link plate, as the pin gear sprocket may interfere with the rail.

3) When wrapped partially or totally around the outside of a drum:

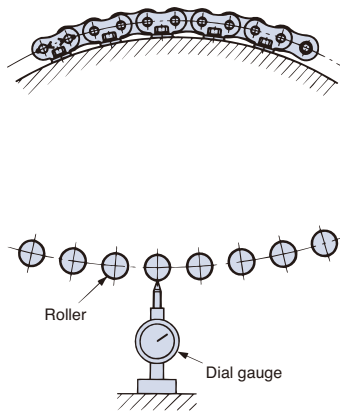

- Attachment chain length is in the range of -0.05 to 0.15% of standard length (nominal pitch x number of links). When the chain is wrapped around a drum, shims need to be used between the drum and the chain attachments to eliminate slack.
- Since K attachments can be adjusted with shims, they can be attached onto the drum more easily than SK attachments.
- When the drum is not perfectly round, the thickness of the shims needs to be adjusted while the chain is wrapped around the drum so the radius is circular. As shown below, a dial gauge or a surface gauge can be used for adjustment.
- Process tap holes to fit the holes of the chain attachments.

4) When wrapped partially or totally around the inside of a drum:

- Contact a Tsubaki representative.

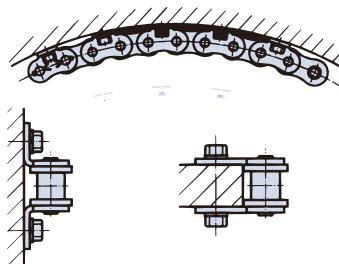

5) When used for lateral wrapping (horizontal drive)

- See section 3).
- Contact a Tsubaki representative for internal fits.

6) Sprocket attachment

- Adjust the shaft of the sprocket so that the sprocket engages the chain straight.
 Note: Curved chains do not contact the sprocket straight on and are not suitable for use with pin gears.
- The clearance (α) between the rollers and the bottom of the sprocket teeth should be less than the dimensions shown in the following table. The bottom of the teeth and rollers should not touch each other.

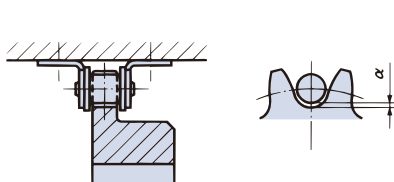

Chain size	α
RS80 or less	1.0mm
RS100 to RS180	1.5mm
RS200 or more	2.0mm

- When the bottom of the teeth and rollers touch each other in the clearance described above, the tooth form needs to be pre-designed with larger clearance α . Contact a Tsubaki representative for details.

Roller Chain Selection

Chain Type Pin Gear Drive Selection Method Procedure

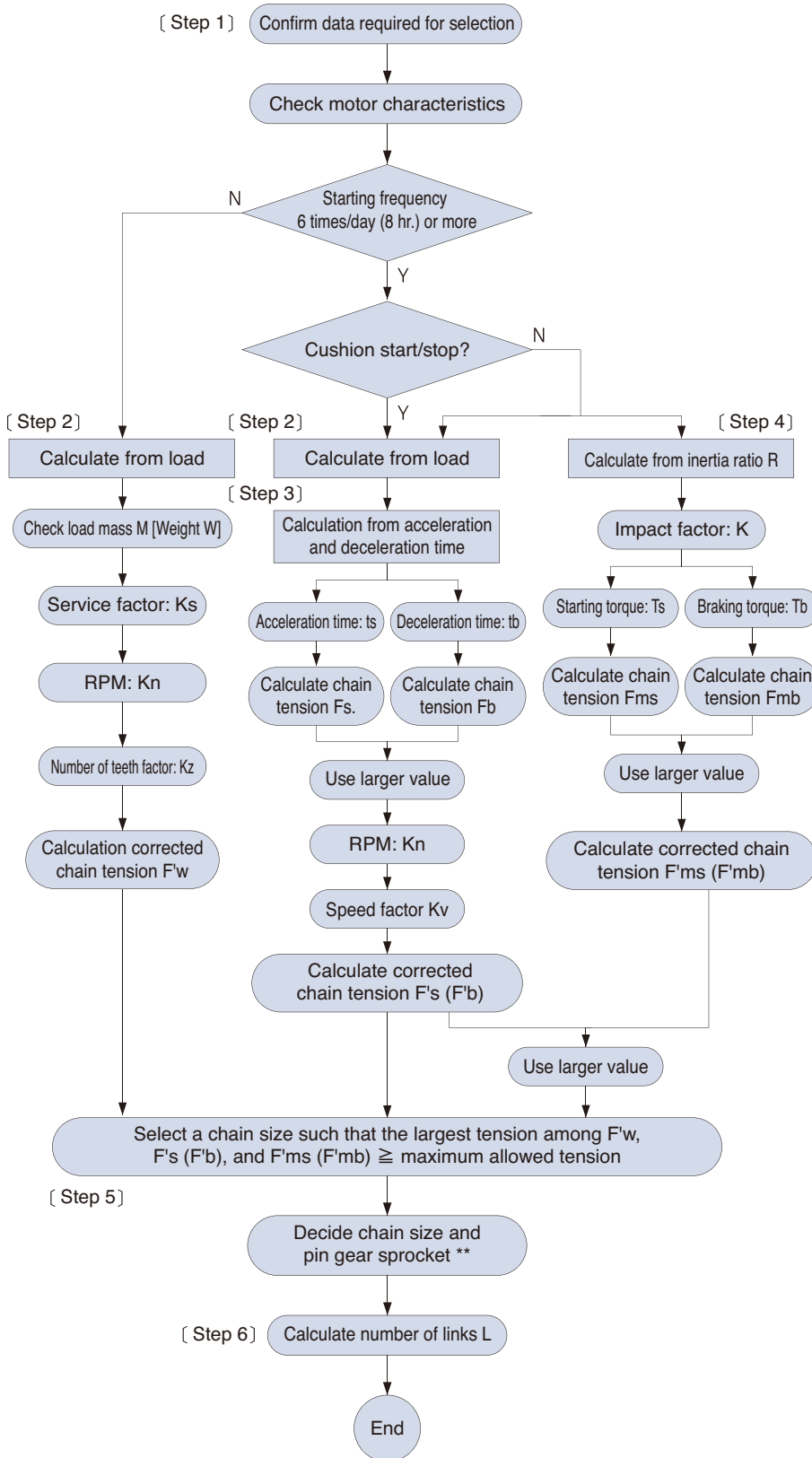

(Note) Chain relative speed V is 50 m/min or less.

(When V is greater than 50 m/min)
 Linear: Roll drive, etc.
 Drum: Change chain attachment diameter → Reduce size.

Pin gear speed factor Kv

Relative chain speed	Pin gear speed factor
0 to 15 m/min	1.0
15 to 30	1.2
30 to 50	1.4

** See pg. 142 for pin gear drive sprockets.
 This sprocket is exclusively for special tooth shapes.
 $N \geq 13^{\dagger}$, with $N = 18^{\dagger}$ recommended.
 Refer to previous sections for pin gear drive handling.

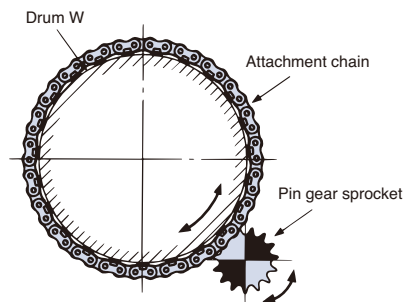
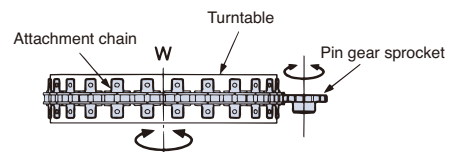
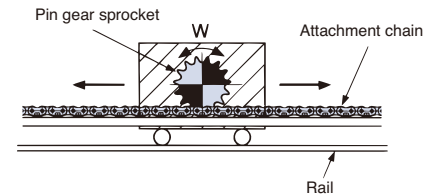
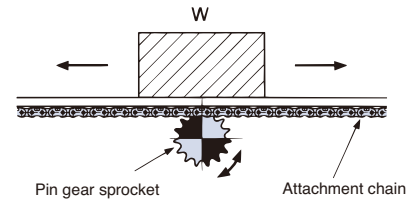

Before Use
 Standard Roller Chains
 Lube-Free Roller Chains
 Heavy Duty Roller Chains
 Corrosion Resistant Roller Chains
 Specialty Roller Chains
 Sprockets
 Pin Gear Drives
 Accessories
 Selection
 Handling

Pin gear drive selection example

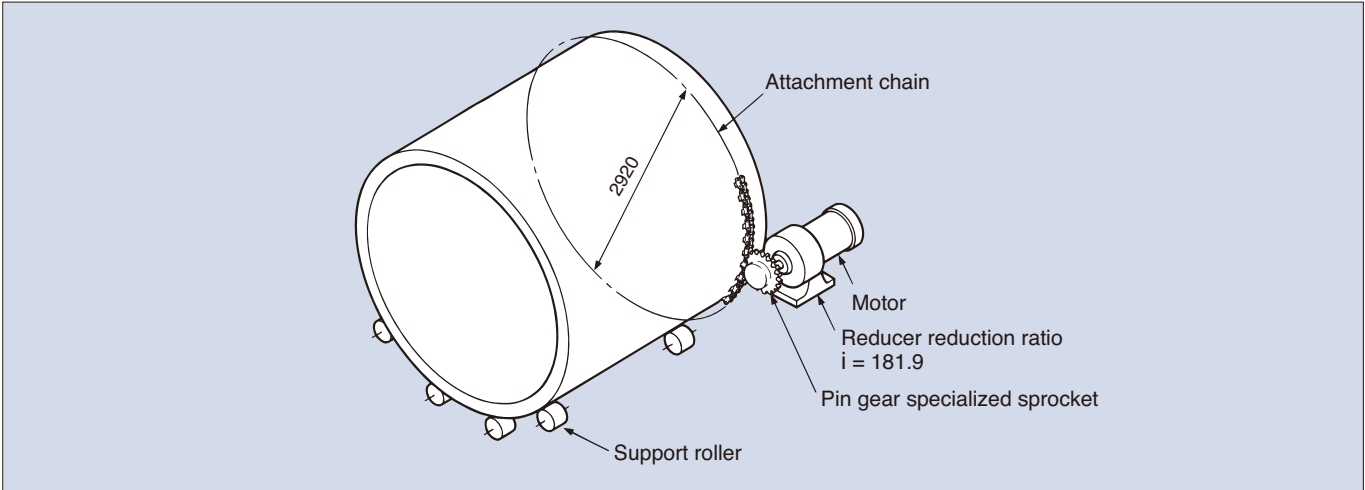

SI units

[Step 1] Check machine and motor characteristics

Machine: Cutting machine
 Motor: 15 kW, 4P, 1750 rpm

Motor moment of inertia $I : I_m = 0.00425 \text{ kg} \cdot \text{m}^2$

Starting torque T_s 290%
 Maximum (stalling) torque T_{max} 305%
 Braking torque T_b 180%
 Reducer reduction ratio i 181.9
 Forward and reverse operation frequency ... Max 900 times/hour
 Sprocket pitch circle diameter (PCD) ... Approximately $\phi 220 \text{ mm}$

Moment of inertia for the motor shaft converted load $I : I_\ell = 0.00072 \text{ kg} \cdot \text{m}^2$
 There is no play in the chain.

[Step 2] Calculation from load

$$\text{Revolution speed of the pin gear drive sprocket } n = 1750 \times \frac{1}{181.9} = 9.6 \text{ rpm}$$

$$\text{Relative chain speed } v = \frac{220 \times \pi \times 9.6}{1000} = 6.6 \text{ m/min} \cdots \text{Speed factor } K_v = 1.0$$

Some impact assumed from cutting machine Service factor $K_s = 1.3$

Load is calculated from the torque on the drive side as the mass of the load is unknown.

$$\begin{aligned} \text{Rated torque of the motor } T_n &= 9.55 \times \frac{\text{kW}}{n_1} \\ &= 9.55 \times \frac{1.5}{1750} \\ &= 0.00819 \text{ (kN} \cdot \text{m)} \end{aligned}$$

$$\begin{aligned} \text{Pin gear drive sprocket shaft torque} \\ T &= T_n \times i = 0.00819 \times 181.9 \\ &= 1.49 \text{ (kN} \cdot \text{m)} \end{aligned}$$

$$\begin{aligned} \text{Chain working tension } F &= \frac{2T}{d} = \frac{2 \times 1.49}{220} \\ &= 13.6 \text{ (kN)} \end{aligned}$$

$$\begin{aligned} \text{Design chain tension } F'w &= F \times K_s \times K_v \\ &= 13.6 \times 1.3 \times 1.0 \\ &= 17.7 \text{ (kN)} \cdots \cdots \cdots \textcircled{1} \end{aligned}$$

{Gravimetric units}

[Step 1] Check machine and motor characteristics

Machine: Cutting machine
 Motor: 15 kW, 4P, 1750 rpm

GD^2 of the motor $GD^2 = 0.017 \text{ kgf} \cdot \text{m}^2$

Starting torque T_s 290%
 Maximum (stalling) torque T_{max} 305%
 Braking torque T_b 180%
 Reducer reduction ratio i 181.9
 Forward and reverse operation frequency ... Max 900 times/hour
 Sprocket pitch circle diameter (PCD) ... Approximately $\phi 220 \text{ mm}$

GD^2 of the motor shaft converted load: $GD^2_\ell = 0.00072 \text{ kg} \cdot \text{m}^2$
 There is no play in the chain.

[Step 2] Calculation from load

$$\begin{aligned} \text{Rated torque of the motor } T_n &= 974 \times \frac{\text{kW}}{n_1} \\ &= 974 \times \frac{1.5}{1750} \\ &= 0.835 \text{ (kgf} \cdot \text{m)} \end{aligned}$$

$$\begin{aligned} \text{Pin gear drive sprocket shaft torque} \\ T &= T_n \times i = 0.835 \times 181.9 \\ &= 152 \text{ (kgf} \cdot \text{m)} \end{aligned}$$

$$\begin{aligned} \text{Chain working tension } F &= \frac{2T}{d} = \frac{2 \times 152}{220} \\ &= 1380 \text{ (kgf)} \end{aligned}$$

$$\begin{aligned} \text{Design chain tension } F'w &= F \times K_s \times K_v \\ &= 1380 \times 1.3 \times 1.0 \\ &= 1790 \text{ (kgf)} \cdots \cdots \cdots \textcircled{1} \end{aligned}$$

Roller Chain Selection

[Step 3] Calculation based on acceleration and deceleration time

$$\begin{aligned} \text{Working torque } T_m &= \frac{T_s + T_b}{2 \times 100} \times T_n \\ &= \frac{290 + 305}{2 \times 100} \times 0.00819 \\ &= 0.0244 \text{ (kN} \cdot \text{m)} \end{aligned}$$

As the load is unknown, the rated torque of the motor is $T_n = T_\ell$ and the load torque $T_\ell = 0.00819 \text{ kN} \cdot \text{m}$ $\{0.835 \text{ kgf} \cdot \text{m}\}$

$$\begin{aligned} \text{Acceleration time } t_s &= \frac{(I_m + I_\ell) \times n}{9550 \times (T_m - T_\ell)} \\ &= \frac{(0.00425 + 0.00072) \times 1750}{9550 \times (0.0244 - 0.00819)} \\ &= 0.056 \text{ (s)} \end{aligned}$$

$$\text{Motor braking torque } T_b = 0.00819 \times 1.8 = 0.0147$$

$$\begin{aligned} \text{Deceleration time } t_b &= \frac{(I_m + I_\ell) \times n}{9550 \times (T_b + T_\ell)} \\ &= \frac{(0.00425 + 0.00072) \times 1750}{9550 \times (0.0147 + 0.00819)} \\ &= 0.040 \text{ (s)} \end{aligned}$$

Moment of inertia I for the motor shaft converted load $I_\ell = 0.00072 \text{ kg} \cdot \text{m}^2$
 $F_w = F = 13.6 \text{ (kN)}$ [value from Step 2]

$t_b < t_s$, so find the chain tension during deceleration.

Motor shaft angular velocity $\omega = 2\pi \times n = 2\pi \times 1750 = 11000 \text{ rad}$

$$\begin{aligned} \text{Motor shaft angular deceleration } \omega_b &= \frac{\omega}{60 \times t_b} = \frac{11000}{60 \times 0.040} \\ &= 4580 \text{ (rad/s}^2\text{)} \end{aligned}$$

$$\begin{aligned} \text{Chain tension during deceleration } F_b &= \frac{I_\ell \times \omega_b \times i}{1000 \times \left\{ \frac{d}{(2 \times 1000)} \right\}} + F_w \\ &= \frac{0.00072 \times 4580 \times 181.9}{1000 \times \left\{ \frac{220}{(2 \times 1000)} \right\}} + 13.6 \\ &= 19.1 \text{ (kN)} \end{aligned}$$

Design chain tension during deceleration

$$\begin{aligned} F'_b &= F_b \times K_v \\ &= 19.1 \times 1.0 \\ &= 19.1 \text{ (kN)} \dots\dots\dots \textcircled{2} \end{aligned}$$

[Step 4] Calculation based on the inertia ratio R

$$\begin{aligned} \text{Inertia ratio } R &= \frac{I_\ell}{I_m} = \frac{0.00072}{0.00425} \\ &= 0.17 \end{aligned}$$

According to Table 4, impact factor $K = 0.23$ (There is no play in the drive transmission equipment as $R < 0.2$, $R = 0.2$.)

$$\begin{aligned} \text{Chain tension at start-up } F_{ms} &= \frac{T_s \times i}{\left(\frac{d}{2 \times 1000} \right) \times 100} \times T_n \\ &= \frac{290 \times 181.9}{\left(\frac{220}{2 \times 1000} \right) \times 100} \times 0.00819 \\ &= 39.3 \text{ (kN)} \end{aligned}$$

$$\begin{aligned} \text{Chain tension at stop } F_{mb} &= \frac{T_b \times i}{\left(\frac{d}{2 \times 1000} \right) \times 100} \times T_n \times 1.2 \\ &= \frac{180 \times 181.9}{\left(\frac{220}{2 \times 1000} \right) \times 100} \times 0.00819 \times 1.2 \\ &= 29.3 \text{ (kN)} \end{aligned}$$

$$\begin{aligned} \text{As } F_{ms} > F_{mb}, \\ \text{Design chain tension } F'_{ms} &= F_{ms} \times K \times K_v \\ &= 39.3 \times 0.23 \times 1.0 \\ &= 9.04 \text{ (kN)} \dots\dots\dots \textcircled{3} \end{aligned}$$

[Step 3] Calculation based on acceleration and deceleration time

$$\begin{aligned} \text{Working torque } T_m &= \frac{T_s + T_b}{2 \times 100} \times T_n \\ &= \frac{290 + 305}{2 \times 100} \times 0.835 \\ &= 2.48 \text{ (kgf} \cdot \text{m)} \end{aligned}$$

$$\begin{aligned} \text{Acceleration time } t_s &= \frac{(GD^2_m + GD^2_\ell) \times n}{375 \times (T_m - T_\ell)} \\ &= \frac{(0.017 + 0.00288) \times 1750}{375 \times (2.48 - 0.835)} \\ &= 0.056 \text{ (s)} \end{aligned}$$

$$\text{Motor braking torque } T_b = 0.835 \times 1.8 = 1.50 \text{ (kgf} \cdot \text{m)}$$

$$\begin{aligned} \text{Deceleration time } t_b &= \frac{(GD^2_m + GD^2_\ell) \times n}{375 \times (T_b + T_\ell)} \\ &= \frac{(0.017 + 0.00288) \times 1750}{375 \times (1.50 + 0.835)} \\ &= 0.040 \text{ (s)} \end{aligned}$$

GD^2 for the motor shaft converted load $GD^2_\ell = 0.00288 \text{ kgf} \cdot \text{m}^2$
 $F_w = F = 1380 \text{ (kgf)}$ [value from Step 2]

$t_b < t_s$, so find the chain tension during deceleration.

Motor shaft angular velocity $\omega = 2\pi \times n = 2\pi \times 1750 = 11000 \text{ rad}$

$$\begin{aligned} \text{Motor shaft angular deceleration } \omega_b &= \frac{\omega}{60 \times t_b} = \frac{11000}{60 \times 0.040} \\ &= 4580 \text{ (rad/s}^2\text{)} \end{aligned}$$

$$\begin{aligned} \text{Chain tension during deceleration } F_b &= \frac{GD^2_\ell / 4 \times \omega_b \times i}{\left\{ \frac{d}{(2 \times 1000)} \right\} \times G} + F_w \\ &= \frac{0.00288 / 4 \times 4580 \times 181.9}{\left\{ \frac{220}{(2 \times 1000)} \right\} \times 9.80665} + 1380 \\ &= 1940 \text{ (kgf)} \end{aligned}$$

Design chain tension during deceleration

$$\begin{aligned} F'_b &= F_b \times K_v \\ &= 1940 \times 1.0 \\ &= 1940 \text{ (kgf)} \dots\dots\dots \textcircled{2} \end{aligned}$$

[Step 4] Calculation based on the inertia ratio R

$$\begin{aligned} \text{Inertia ratio } R &= \frac{GD^2_\ell}{GD^2_m} = \frac{0.00288}{0.017} \\ &= 0.17 \end{aligned}$$

According to Table 4, impact factor $K = 0.23$ (There is no play in the drive transmission equipment as $R < 0.2$, $R = 0.2$.)

$$\begin{aligned} \text{Chain tension at start-up } F_{ms} &= \frac{T_s \times i}{\left(\frac{d}{2 \times 1000} \right) \times 100} \times T_n \\ &= \frac{290 \times 181.9}{\left(\frac{220}{2 \times 1000} \right) \times 100} \times 0.835 \\ &= 4000 \text{ (kgf)} \end{aligned}$$

$$\begin{aligned} \text{Chain tension at stop } F_{mb} &= \frac{T_b \times i}{\left(\frac{d}{2 \times 1000} \right) \times 100} \times T_n \times 1.2 \\ &= \frac{180 \times 181.9}{\left(\frac{220}{2 \times 1000} \right) \times 100} \times 0.835 \times 1.2 \\ &= 2980 \text{ (kgf)} \end{aligned}$$

$$\begin{aligned} \text{As } F_{ms} > F_{mb}, \\ \text{Design chain tension } F'_{ms} &= F_{ms} \times K \times K_v \\ &= 4000 \times 0.23 \times 1.0 \\ &= 920 \text{ (kgf)} \dots\dots\dots \textcircled{3} \end{aligned}$$

Before Use Standard Roller Chains Lubrication Free Roller Chains Heavy Duty Roller Chains Corrosion Resistant Roller Chains Specialty Roller Chains Sprockets Pin Gear Drives Accessories Selection Handling

[Step 5] Comparison of ①, ②, and ③

Comparing ①, ②, and ③, an attachment chain for pin gears that meets 19.1kN {1940 kgf}, the maximum working load ② is selected.

The maximum allowable load for RS120 attachment chain with pin gear use is 20.6 kN {2100 kgf}, which is acceptable.

The number of the teeth is 18T from the pitch circle diameter of the pin gear specialized sprocket, or approximately $\phi 220$. (PCD = 222.49 mm)

Steps 2, 3, and 4 are calculated again here.

[Step 2]

$$F = \frac{2T}{d} = \frac{2 \times 1.49}{\frac{222.49}{1000}} = 13.4(\text{kN})$$

$$F'w = F \times K_s \times K_v = 13.4 \times 1.3 \times 1.0 = 17.4(\text{kN})$$

[Step 3]

$$F_b = \frac{l \times w \times b \times i}{1000 \times \left\{ \frac{d}{(2 \times 1000)} \right\}} + F_w$$

$$= \frac{0.00072 \times 4580 \times 181.9}{1000 \times \left\{ \frac{222.49}{(2 \times 1000)} \right\}} + 13.4$$

$$= 18.8(\text{kN})$$

Design chain tension during deceleration

$$F'b = F_b \times K_v$$

$$= 18.8 \times 1.0$$

$$= 18.8(\text{kN})$$

[Step 4]

$$F_{ms} = \frac{T_s \times i}{\left(\frac{d}{2 \times 1000} \right) \times 100} \times T_n$$

$$= \frac{290 \times 181.9}{\left(\frac{222.49}{2 \times 1000} \right) \times 100} \times 0.00819$$

$$= 38.8(\text{kN})$$

Design chain tension

$$F'_{ms} = F_{ms} \times K \times K_v$$

$$= 38.8 \times 0.23 \times 1.0$$

$$= 8.92(\text{kN}) \dots \dots \dots \textcircled{3}$$

The above selection is acceptable.

[Step 2]

$$F = \frac{2T}{d} = \frac{2 \times 152}{\frac{222.49}{1000}} = 1370(\text{kgf})$$

$$F'w = F \times K_s \times K_v = 1370 \times 1.3 \times 1.0 = 1780(\text{kgf})$$

[Step 3]

$$F_b = \frac{GD2 \ell / 4 \times w \times b \times i}{\left\{ \frac{d}{(2 \times 1000)} \right\} \times G} + F_w$$

$$= \frac{0.00288 / 4 \times 4580 \times 181.9}{\left\{ \frac{222.49}{(2 \times 1000)} \right\} \times 9.80665} + 1380$$

$$= 1930(\text{kgf})$$

Design chain tension during deceleration

$$F'b = F_b \times K_v$$

$$= 1930 \times 1.0$$

$$= 1930(\text{kgf})$$

[Step 4]

$$F_{ms} = \frac{T_s \times i}{\left(\frac{d}{2 \times 1000} \right) \times 100} \times T_n$$

$$= \frac{290 \times 181.9}{\left(\frac{222.49}{2 \times 1000} \right) \times 100} \times 0.835$$

$$= 3960(\text{kgf})$$

Design chain tension

$$F'_{ms} = F_{ms} \times K \times K_v$$

$$= 3960 \times 0.23 \times 1.0$$

$$= 911(\text{kgf}) \dots \dots \dots \textcircled{3}$$

The above selection is acceptable.

[Step 6] Calculation of the number of links L

$$\text{Calculating number of links } L = \frac{180^\circ}{\tan^{-1}\left(\frac{P}{D+2S}\right)} = \frac{180^\circ}{\tan^{-1}\left(\frac{38.1}{2920}\right)} = 240.8 \dots \dots 242 \text{ links}$$

Corresponding standard length for 242 links ($38.1 \times 242 = 9220.2\text{mm}$) $D + 2S = 2935\text{mm}$

[Conclusion] Chain: RS120 K1 attachments on every 2nd link with 242 links; Sprocket: RS120 pin gear specialized sprocket 18T carbon steel for machine structural use, teeth induction hardened.

(Cautions)

- ① Ambient conditions during applications are not taken into consideration. When the ambient conditions are not adequate, the selection needs to be made in consideration of the conditions.
- ② Refer to Section 10.2 on page 182 for cautions regarding pin gears.

Roller Chain Selection

11. Temperature Selection Method

11.1 RS Roller Chain temperature selection method

This selection method is for sizes that may experience strength degradation from temperature. Additionally, lubrication should be carried out using a suitable lubricant according to the operating temperatures.

- | | |
|---|--|
| 1) Problems with roller chain transmission at high temperatures <ul style="list-style-type: none"> ● Increased wear due to hardness reduction ● Increased elongation due to softening ● Poor articulation and increased wear due to oil degradation and carburization ● Increased wear and poor articulation due to scaling | 2) Problems with roller chain transmission at low temperatures <ul style="list-style-type: none"> ● Reduction of impact strength due to low temperature brittleness ● Solidification of lubricant ● Poor articulation due to frost and ice adhesion |
|---|--|

Table 7 Maximum allowable load of RS Roller Chain at high and low temperatures

Temperature	RS roller chain		RS Cold Resistant Chain *
	RS60 or under	RS80 or over	
Below - 60°C	–	–	Unusable
- 60°C to - 50°C	–	–	Catalog Value × 1/2
- 50°C to - 40°C	–	Unusable	∕ × 2/3
- 40°C to - 30°C	Unusable	Catalog Value × 1/4	Catalog Value
- 30°C to - 20°C	Catalog Value × 1/4	∕ × 1/3	∕
- 20°C to - 10°C	∕ × 1/3	∕ × 1/2	∕
- 10°C to 60°C	Catalog Value	Catalog Value	∕
60°C to 150°C	Catalog Value	Catalog Value	∕
150°C to 200°C	∕ × 3/4	∕ × 3/4	Unusable
200°C to 250°C	∕ × 1/2	∕ × 1/2	–
Over 250°C	Unusable	Unusable	–

Note)
 1. * RS Cold Resistant Chain
 ● Made to order
 ● Select using allowable load selection method
 2. The ambient temperature is different from the temperature of the roller chain itself.

11.2 Lambda Chain KF Series Lube Free Drive Chain Selection

Use the kilowatt ratings chart based selection method for selecting lube free drive chains.

$$\text{Corrected kW} < \text{kW ratings} = \text{Catalog kW ratings} \times \text{Temperature coefficient}$$

Note: The chain is usable if the kilowatt ratings are greater than the corrected kW.

Multiply the ambient temperature the chain will be used in by the temperature coefficient in Table 2 below to calculate kilowatt ratings. Calculate the temperature coefficient with the maximum usage temperature of the equipment on which the chain will be installed.

Table 2: Temperature Coefficient by Ambient Temperature

Temperature	RS40 – RS80
Room temperature – 150°C	Catalog kW rating × 1
150°C – 200°C	Catalog kW rating × 3/4
200°C – 230°C	Catalog kW rating × 1/2

Note: A double-strand LMC chain only has the maximum allowable load of a single-strand LMD chain. Always confirm strength when using for power transmission.

11.3 Selection method for Stainless Steel Roller Chain (SS and NS series) at high temperatures (400°C or higher)

As the temperature of a chain increases, its strength decreases. The usage limit at high temperatures is determined by the temperature of the chain itself. Contact a Tsubaki representative when using stainless steel chain at ambient temperatures of 400°C or higher. However, chain cannot be used at 700°C or higher. When a chain is selected using the temperature selection method, the chain speed must be below the maximum speed of the allowable load selection method.

Changes and cautions associated with high temperature environments are:

- 1) All clearances need to be adjusted to prevent poor articulation and poor roller rotation due to thermal expansion.
- 2) The chain may break (creep rupture) under low loads as the temperature increases.

12. Special selection method for Corrosion Resistant Roller Chain

When selecting Corrosion Resistant Chain use the allowable load selection method.

- 1) The maximum allowable tension for Corrosion Resistant Chain is low compared to Standard RS Roller Chain (excluding NEP).
- 2) Avoid using offset links when possible.
- 3) Refer to the following page when acid or alkali solutions or chemicals will come in direct contact with the chain.
- 4) Selection formula:

$$\text{Maximum working load applied to the chain} \times \text{Service factor } K_s \times \text{RPM } K_n \times \text{Number of teeth factor } K_z \leq \text{Maximum allowable load of the chain}$$

Before Use | Standard Roller Chains | Lube-Free Roller Chains | Heavy Duty Roller Chains | Corrosion Resistant Roller Chains | Specialty Roller Chains | Sprockets | Pin Gear Drives | Accessories | Selection | Handling

13. Corrosion resistance guide for Corrosion Resistant Chains and Sprockets

Corrosion resistance varies accordingly depending on application conditions. This table should not be considered as a guarantee. Using this chart as a reference, be sure to check the corrosion resistance of the chain in advance according to the actual operating conditions determining chain type.

- : Sufficient corrosion resistance
- △ : Corrosion resistance in some applications
- × : No corrosion resistance
- : Unknown

Chemical / Food product	Corrosion-Resistant Drive Chain							Sprocket	
	SS	LSC	AS	NS	TI	PC	PC-SY	Engineering plastic	SS
Acetic acid 10% 20°C	○	○	○	○	○	○	○	△	○
Acetone 20°C	○	○	○	○	○	○	×	○	○
Alcohol (Methyl, ethyl, propyl, and butyl)	○	○	○	○	○	○	○	○	○
Aluminum sulfate Saturated 20°C	○	○	×	○	○	-	-	-	○
Ammonia water 20°C	○	○	○	○	○	○	○	○	○
Ammonium chloride 50% Boiling point	△	△	×	○	○	-	-	-	△
Ammonium nitrate Saturated boiling	○	○	○	○	○	△	○	○	○
Ammonium sulfate " 20°C	○	○	△	○	○	-	-	-	○
Beer 20°C	○	○	○	○	○	○	○	○	○
Benzene 20°C	○	○	○	○	○	○	○	○	○
Boric acid 50% 100°C	○	-	○	○	○	-	-	-	○
Butyric acid 20°C	○	-	○	○	○	-	-	-	○
Calcium chloride " 20°C	△	-	×	○	○	△	○	△	△
Calcium hydroxide 20% Boiling	○	-	○	○	○	○	○	-	○
Calcium hypochlorite (Bleaching powder) Available chlorine 11~14% 20°C	○	-	×	○	○	×	○	△	○
Carbolic acid 20°C	○	-	○	○	○	×	○	×	○
Carbon tetrachloride (Dry) 20°C	○	○	○	○	○	○	○	○	○
Carbonated water	○	○	○	○	○	-	-	-	○
Chlorine gas (Dry) 20°C	△	-	×	△	○	-	○	×	△
Chlorine gas (Wet) 20°C	×	×	×	△	○	-	○	×	×
Chlorine water	×	×	×	○	○	×	-	×	×
Chromic acid 5% 20°C	○	○	△	○	○	×	○	×	○
Citric acid 50% 20°C	○	○	○	○	○	-	-	○	○
Coffee Boiling	○	○	○	○	○	○	○	○	○
Cola syrup	○	○	○	○	○	○	○	○	○
Concentrated nitric acid 65% 20°C	○	×	×	○	○	×	○	×	○
" " Boiled	△	×	×	△	○	×	×	×	△
Creosote 20°C	○	-	○	○	○	-	-	-	○
Developing solution (Photo) 20°C	○	-	△	○	○	○	○	○	○
Ether (Ethyl ether) 20°C	○	○	○	○	○	○	○	○	○
Ferric chloride 5% 20°C	△	△	×	△	○	-	-	×	△
Formalin (Formaldehyde) 40% 20°C	○	○	○	○	○	-	-	△	○
Formic acid 50% 20°C	○	×	○	○	○	×	○	×	○
Fruit juice 20°C	○	○	△	○	○	○	○	○	○
Gasoline 20°C	○	○	○	○	○	○	○	○	○
Glycerine 20°C	○	○	○	○	○	○	○	○	○
Honey, syrup	○	○	○	○	○	○	○	○	○
Hydrochloric acid 2% 20°C	×	×	×	×	○	×	○	×	×
Hydrogen peroxide 30% 20°C	○	-	△	○	○	×	○	×	○
Hydrogen sulfide (Dry)	○	-	○	○	○	○	○	○	○
" (Moistened)	×	×	×	×	○	×	-	-	×
Kerosene 20°C	○	○	○	○	○	-	-	-	○
Ketchup 20°C	○	○	○	○	○	○	○	○	○
Lactic acid 10% 20°C	○	○	△	○	○	-	-	○	○
Lard	○	-	○	○	○	-	-	-	○
Linseed oil 100% 20°C	○	-	△	○	○	-	-	-	○

Chemical / Food product	Corrosion-Resistant Drive Chain							Sprocket	
	SS	LSC	AS	NS	TI	PC	PC-SY	Engineering plastic	SS
Malic acid 50% 50°C	○	○	○	○	○	○	○	○	○
Mayonnaise 20°C	○	○	△	○	○	○	○	○	○
Milk 20°C	○	○	○	○	○	○	○	○	○
Nitric acid 5% 20°C	○	-	△	○	○	×	○	×	○
Oil (Plant and mineral) 20°C	○	○	○	○	○	○	○	○	○
Oleic acid 20°C	○	○	○	○	○	○	-	○	○
Oxalic acid 10% 20°C	○	○	△	○	○	-	○	○	○
Paraffin 20°C	○	○	○	○	○	○	○	○	○
Petroleum 20°C	○	-	○	○	○	○	-	○	○
Phosphoric acid 5% 20°C	○	-	△	○	○	×	○	×	○
" 10% 20°C	△	×	△	△	○	×	○	×	△
Picric acid Saturated 20°C	○	-	○	○	○	-	-	-	○
Potassium chloride Saturated 20°C	○	○	△	○	○	-	-	-	○
Potassium dichromate 10% 20°C	○	○	○	○	○	○	-	○	○
Potassium hydroxide 20% 20°C	○	×	○	○	○	○	○	○	○
Potassium nitrate 25% 20°C	○	○	○	○	○	○	-	○	○
" 25% Boiling point	○	-	×	○	○	-	-	-	○
Potassium permanganate Saturated 20°C	○	○	○	○	○	-	○	×	○
Seawater 20°C	△	△	×	○	○	△	○	○	△
Soapy water 20°C	○	○	○	○	○	○	○	○	○
Sodium carbonate Saturated boiling point	○	○	○	○	○	-	○	△	○
Sodium chloride " 20°C	○	○	△	○	○	○	○	○	○
Sodium cyanide 20°C	○	○	-	○	○	-	-	-	○
Sodium hydrogen carbonate 20°C	○	○	○	○	○	○	-	○	○
Sodium hydroxide 25% 20°C	○	×	○	○	○	○	○	○	○
Sodium hypochlorite 10% 20°C	×	×	×	○	○	×	○	△	×
Sodium perchlorate 10% Boiling point	○	-	×	○	○	-	-	-	○
Sodium sulfate Saturated 20°C	○	○	○	○	○	-	-	-	○
Sodium thiosulfate 25% Boiling point	○	○	○	○	○	-	-	-	○
Soft drink 20°C	○	○	○	○	○	○	○	○	○
Stearic acid 100% Boiling point	×	×	×	○	○	×	-	○	×
Sugar solution 20°C	○	○	○	○	○	○	○	○	○
Sulfur Dioxide (Wet) 20°C	○	-	×	○	○	-	-	-	○
Sulfuric acid 5% 20°C	×	×	×	○	○	×	○	×	×
Synthetic detergent	○	○	○	○	○	○	○	○	○
Tartaric acid 10% 20°C	○	○	○	○	○	○	○	○	○
Turpentine oil 35°C	○	-	○	○	○	-	-	-	○
Varnish	○	-	○	○	○	-	-	-	○
Vegetable juice 20°C	○	○	○	○	○	○	○	○	○
Vinegar 20°C	△	-	×	○	○	△	○	△	△
Water	○	○	○	○	○	○	○	○	○
Whiskey 20°C	○	○	○	○	○	○	○	○	○
Wine 20°C	○	○	○	○	○	○	○	○	○
Zinc chloride 50% 20°C	△	△	×	△	○	△	○	×	△
Zinc sulfate 25% Saturated 20°C	○	○	○	○	○	-	○	-	○

Handling Roller Chains and Sprockets

1. How to Cut Roller Chain

If the chain you purchased is either a unit length (3,048 mm) or on a reel, it is necessary for you to cut the chain to the necessary length.

How to cut a roller chain — Using a chain vise and punch
— Using a chain breaker

1.1 Using a chain vise and punch

- 1) For riveted type roller chain, grind down one end of the outer plate's two pins (same side) to the surface of the plate. Be careful of the chain overheating during the grinding process. This process is unnecessary for Poly Steel Chain as there are no rivets. As RS08B-1 to RS16B-1 use easy cutting pins, the rivets do not need to be ground.
- 2) Remove the cotter pin for cotter pin type roller chain.

(Grind the rivets of the pins until they are flush with the plate.)

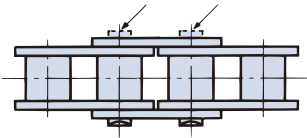

Fig. 1 Rivet-type roller chain

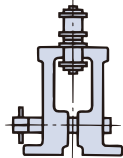

Fig. 2 Grinding the pin ends

- 3) Place the roller chain into the groove of the chain vise (see Accessories Section) and tighten the vise to secure the roller to be disassembled.
 - ① Follow 1.3 and 1.4 for Poly Steel Chain and Lambda chain.
 - ② For multi-strand Super Roller Chain, place the lowest roller into the groove of the chain vise.



Fig. 3 Setting the roller chain in the chain vise



Setting Super Roller Chain

- 4) Place a primary punch (see Accessories Section), according to chain size, on the head of the ground pin, and then hit the head of the primary punch with a hammer. Make sure to hit the pins alternatively to ensure the pins are removed evenly and at the same time. Continue to tap the pin until just before the pin is removed from the outer plate.

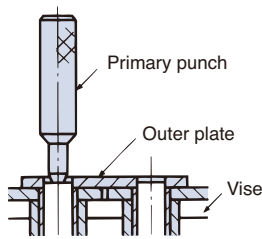

Fig. 4 Tapping the pin with the primary punch

- 5) Use a secondary punch (see Accessories Section) to remove the pin completely from the outer link plate. Check to make sure that the bush where the pin was removed has not come loose or deformed. Do not use if loose or deformed.

⚠ Safety precautions

- ① Make sure to use a grinder when grinding the riveted portion of one end of the rivet-type pin. If it is extracted without being ground first, more time and effort will be spent, and will damage the chain.
- ② Do not reuse any removed parts.

1.2 Using a chain breaker

- 1) For riveted type roller chain, grind down one end of the outer plate's two pins (same side) to the surface of the link plate. (Same as 1.1) Remove the cotter pin for cotter pin type roller chain.
- 2) Remove the two pins from the same outer plate. Check to make sure that the bush where the pin was removed has not come loose or deformed. Do not use if loose or deformed.



Fig. 5 How to cut a chain using a chain screw

⚠ Safety precautions

- ① A chain breaker (see Accessories Section) is a tool made for cutting chain, and can cut roller chain that is set on a machine. In this case, it is necessary beforehand to support the load on the roller chain and the weight of the roller chain itself to prevent it from falling after being cut.
- ② Do not reuse any removed parts.

1.3 How to cut Poly Steel Chain

- 1) Support the outer plate of the chain in the cradle and push down on the pinhead with the exclusive punch. Then lightly hit the head of the punch using a hammer.
- 2) Avoid using excess force on the engineering plastic part, as there is a possibility of causing damage.

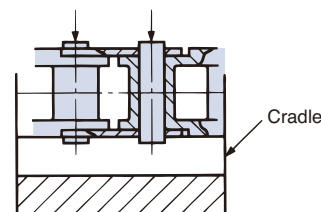

Fig. 6 Poly Steel Chain set in a cradle

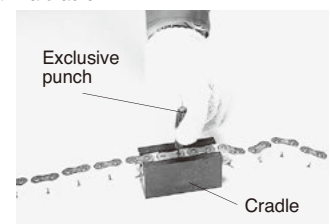

Fig. 7 Cutting Poly Steel Chain

1. 1 How to cut Lambda Chain

- 1) Support the chain with a chain vise and grind down one end of the outer link plate's two pins (same side) to the surface of the link plate. Be careful of the chain overheating during the grinding process. Grinding should be carried out slowly so as not to overheat the bushes in particular.
- 2) Then cut the chain using an exclusive cradle (see Accessories section) and an RS Roller Chain punch. Important points for cutting are outlined in 4) and 5) in 1.1. However, use an exclusive cradle instead of a vise.
- 3) Hit the pins alternatively when removing the pins with a punch. Take extra care not to remove or cause any damage to the bush. Do not use bush if it has come loose or been damaged.

2. How to Connect Roller Chain

2. 1 When connecting chain on sprocket teeth

When connecting or disconnecting roller chain, it is convenient to use the sprocket teeth. Please carry out the following steps.

- 1) Wind the chain around one of the sprockets so that both ends of the chain are facing each other on the sprocket.
- 2) Insert the connecting link in the two end links of the chain.
- 3) Insert the connecting link plate of the connecting link and fasten the plate using the clips/cotter pins or spring pins provided.
- 4) When using a press-fit connecting link or F-Type (semi press-fit) connecting link, insert the connecting link plate by tapping it with a hammer until it moves into position. Then fasten it using the clips/cotter pins or spring pins provided.
- 5) When using the sprocket teeth to connect the chain, take care not to damage the teeth, particularly when using a cast iron sprocket.



Fig. 8 Connecting on a sprocket

2. 2 When connecting between shafts

If a sprocket cannot be used due to layout, follow the procedures below.

- 1) Wind the chain around the sprockets and pull the chain ends together using a chain puller (see Accessories section) or wire.
- 2) Insert the connecting link in the two end links of the chain.
- 3) Insert the connecting link plate of the connecting link and fasten the plate using the clips/cotter pins or spring pins provided.

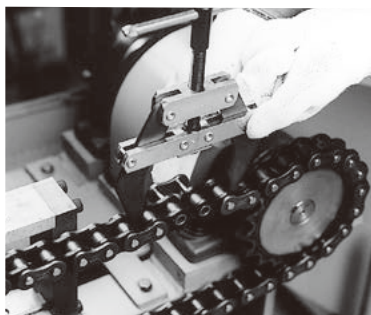

Fig. 9 Connecting between shafts

2. 3 Clip and Cotter Pins

1) Clip

Clips are used for small size roller chain (under RS60) connecting links. When connecting the chain, the clip should be inserted securely into the slot of the pin on the connecting link after the connecting plate has been inserted on the pin. If the legs of the clips are spread too far they will not catch properly and will fall off during operation of the chain, causing accidents. Care should be taken when inserting them. The clip is generally installed opposite to the direction of travel for the chain as shown in Fig. 10.

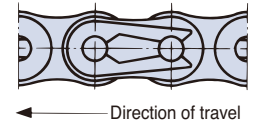

Fig. 10 Direction in which the clip is installed

2) Cotter Pins

Tsubaki cotter pins are heat treated for Standard, Heavy-Duty, and Lambda Chain. The legs of the cotter pin should be bent approx. 60 degrees. Cotter pins should not be reused, and commercially available cotter pins other than those produced by Tsubaki should be avoided.

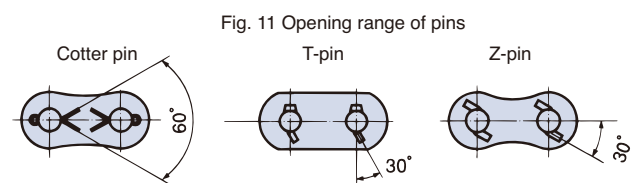

Fig. 11 Opening range of pins

RS Roller Chain cotter pin dimensions (These pins are not available commercially.)

Chain size	Nominal cotter pin dimension	Chain size	Nominal cotter pin dimension
RS35	1 × 6	RS100	2.5 × 20
RS40	1 × 6	RS120	3 × 23
RS50	1.6 × 8	RS140 · RS160	4 × 24.5
RS60	2 × 10	RS180	5 × 32
RS80	2.5 × 14	RS200	5 × 37

Note: RS240 uses a roll pin.

⚠ Safety Precautions

- ① Avoid using offset links wherever possible by varying the center distance between shafts or using an idler.
- ② In the case of pins and connecting link plate holes being press-fit type with F-Type or other connecting links, please avoid widening the connecting link plate hole or narrowing the pin diameter to make connecting easier, as this will result in a reduction in roller chain strength and cause an accident.
- ③ The outer link of cotter pin type roller chain can be used as a substitute for the connecting link. However, due to the press fit connection, the outer link plate must be carefully driven onto the pin parallel to the connecting link. If the connecting link plate is installed without due care to parallelism, chain damage or increased wear may result. Use caution as per (2) above.
- ④ Do not reuse press fit type link plates that have been detached, as the detachment results in a reduction in strength.

Handling Roller Chains and Sprockets

3. Roller Chain Lubrication

Lubrication is very important in roller chain transmission, and becomes especially important when stringent demands are placed on chain performance.

When lubrication is not complete, even the most advanced transmission device will not realize its full service life. Under some conditions the device may wear out within a very short period of time. For this reason, exercise special care with respect to lubrication.

- 1) The main reason for lubing and greasing roller chain is to minimize wear elongation of the chain and prevent corrosion. Wear elongation is caused by wear between the pin and bush in articulating parts.
- 2) Roller chain is coated with lube before being packaged (except for stainless steel chain). This lube is a high grade oil that prevents rust and provides lubrication. The lube prevents the wear that frequently occurs in the initial stage of operation, and it works well with other lubricants to maintain a high wear resistance.
- 3) Avoid wiping the lube coating off of delivered roller chain, and avoid washing the chain with detergent or other cleaning agents.

3.1 Oil application locations

- 1) Roller chain wear occurs from wear between each pin and bush, and thus oil must be applied to these parts.
- 2) On the slack part of the chain, apply lubricant to the gap between each outer plate and inner plate. At the same time, apply lubricant between the bushes and rollers.

3.3 Recommended lubricants

1) SAE numbers (Table 1)

Lubricant type Ambient temperature	A I · A II · B				C			
	-10°C to 0°C	0°C to 40°C	40°C to 50°C	50°C to 60°C	-10°C to 0°C	0°C to 40°C	40°C to 50°C	50°C to 60°C
Chain number								
RS50 or lower small pitch chain	SAE10W	SAE20	SAE30	SAE40	SAE10W	SAE20	SAE30	SAE40
RS60 / 80	SAE20	SAE30	SAE40	SAE50				
RS100						SAE20	SAE30	SAE40
RS120 or higher large pitch chain	SAE30	SAE40	SAE50					

2) Commercially available lubricants (Table 2)

Manufacturer names are shown in no particular order

ISOVG (cSt@40°C)	SAE	SAE10W	SAE20	SAE30	SAE40	SAE50
Manufacturer name		32	68	100	150	220
Idemitsu Kosan		Daphne Mechanic Oil 32	∕ 68	∕ 100	∕ 150	∕ 220
EMG Lubricants		DTE Oil Light	∕ Heavy Medium	∕ Heavy	Vacuoline 580	Vacuoline 533
JXTG Nippon Oil & Energy		Super Mulpus DX32	∕ 68	∕ 100	∕ 150	∕ 220
		FBK Oil RO32	∕ 68	∕ 100	∕ 150	∕ 220

3) Examples of lubrication at low and high temperatures (Table 3)

The following lubricants are available when roller chain is used at low or high temperatures. Regarding other brands, use an equivalent.

Ambient and operating temperature	-50°C to -25°C	-25°C to 0°C	-10°C to 60°C	60°C to 200°C	150°C to 250°C
Manufacturer name Lubricant name	Toray Dow Corning SH510 Shin-Etsu Chemical KF50 Momentive Performance Materials Japan TSF 431	Sunoco Suniso GS Showa Shell Sekiyu Shell Refrigerator Oil 68K	See above	EMG Lubricants Mobil Vacuoline 546 MORESCO Moresukohai Lube L-150	MORESCO Moresukohai Lube R-220 Sumico Lubricant Hightemp Oil ES Sato Special Oil Hot Oil No.75

Lubrication methods are drip, manual, and brush.

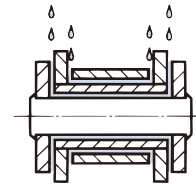
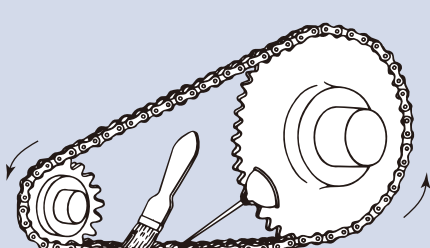
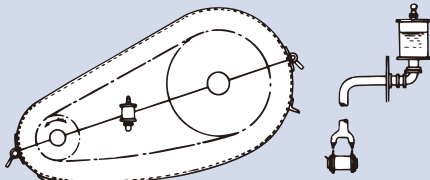
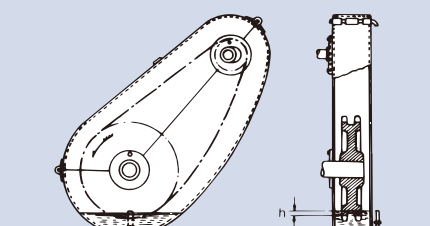
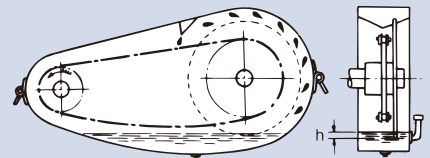
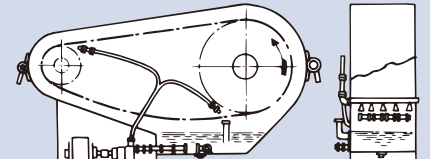

Fig. 10 Lubrication locations

3.2 Chain used for lifting

- 1) In general the chain has no catenary parts. If possible, remove the load that acts on the roller chain before lubing the chain.
- 2) For roller chain that does not articulate, lube the chain sufficiently and then apply a thick layer of grease around the roller chain to prevent corrosion. Sufficiently lube end fitting connections, even if these do not move.
- 3) For roller chain that is used outdoors, contact with rain and snow will remove the lubricant and cause harmful corrosion, and thus a cover or other protection should be installed. If rain or snow does fall on the chain, remove the moisture and then promptly lube the chain and coat it with a thick layer of grease.

3.4 Lubrication systems and methods (Table 4)

Lubrication system	Method	Quantity																																
A	 <p>Apply oil to the gaps in the pins and inner links on the slack side of the chain. A brush can also be used.</p> <p>⚠ Stop operation before oiling.</p>	Oil with sufficient frequency (in general about once every 8 hours) so that the roller chain bearings do not dry out.																																
	<p>Drip Lubrication</p>  <p>Using a simple case, this method drips oil supplied from an oil cup.</p>	For one strand of chain, drip about 5 to 20 drops of oil each minute. Drip more oil on higher speed chains.																																
	<p>Oil Bath</p>  <p>The chain is run through oil in a leak-free casing.</p>	If depth h from the surface of the oil to the lowest point the chain reaches is too deep, the oil may heat up (80°C or higher) and deteriorate. The depth to which the chain descends in the oil should be about 6 to 12 mm.																																
B	<p>Lubrication using a Slinger Disc</p>  <p>Use a slinger disc attached to a leak free case to splash oil on the chain. The peripheral velocity of the disc should be 200 m/min or higher.</p> <p>If the width of the chain is greater than 125 mm, attach discs to both sides.</p>	The lowest point h reached by the slinger disc should be about 12 to 25 mm below the surface of the oil. The roller chain should not enter the oil.																																
	<p>Forced Lubrication</p>  <p>The oil is circulated in a leak-free case and cooled by a pump. When there are n strands of chain, n+1 oiling holes are required, targeting the gaps between each part.</p>	<p>Approximate oiling quantity per oiling hole (L/min)</p> <table border="1"> <thead> <tr> <th rowspan="2">Name</th> <th rowspan="2">Chain number Chain speed (m/min)</th> <th rowspan="2">RS60 or smaller</th> <th># 80</th> <th># 120</th> <th># 160</th> </tr> <tr> <th># 100</th> <th># 140</th> <th>or larger</th> </tr> </thead> <tbody> <tr> <td>RS</td> <td>500 - 800</td> <td rowspan="2">1.0</td> <td rowspan="2">1.5</td> <td rowspan="2">2.5</td> <td rowspan="2">4.0</td> </tr> <tr> <td>SUP</td> <td>Less than 300</td> </tr> <tr> <td>RS</td> <td>800 - 1,100</td> <td rowspan="2">2.0</td> <td rowspan="2">2.5</td> <td rowspan="2">3.5</td> <td rowspan="2">5.0</td> </tr> <tr> <td>SUP</td> <td>300 - 500</td> </tr> <tr> <td>RS</td> <td>1,100 - 1,400</td> <td rowspan="2">3.0</td> <td rowspan="2">3.5</td> <td rowspan="2">4.5</td> <td rowspan="2">6.0</td> </tr> <tr> <td>SUP</td> <td>500 or more</td> </tr> </tbody> </table>	Name	Chain number Chain speed (m/min)	RS60 or smaller	# 80	# 120	# 160	# 100	# 140	or larger	RS	500 - 800	1.0	1.5	2.5	4.0	SUP	Less than 300	RS	800 - 1,100	2.0	2.5	3.5	5.0	SUP	300 - 500	RS	1,100 - 1,400	3.0	3.5	4.5	6.0	SUP
Name	Chain number Chain speed (m/min)	RS60 or smaller				# 80	# 120	# 160																										
			# 100	# 140	or larger																													
RS	500 - 800	1.0	1.5	2.5	4.0																													
SUP	Less than 300																																	
RS	800 - 1,100	2.0	2.5	3.5	5.0																													
SUP	300 - 500																																	
RS	1,100 - 1,400	3.0	3.5	4.5	6.0																													
SUP	500 or more																																	

To verify sufficient lubrication is taking place, remove the chain and inspect the connecting pins and bushes. If the contact surfaces of the pins or bushes show tearing or a red or dark brown color, lubrication is generally not sufficient.

Handling Roller Chains and Sprockets

4. Layout and Installation of Roller Chain

4.1 Speed ratio and chain wrap

A roller chain transmission speed ratio up to 7:1 is normally suitable; however, at very slow speeds a ratio up to about 10:1 is possible. The chain wrap between the small sprocket and chain must be 120° or more. For lifting applications, the angle must be 90° or more.

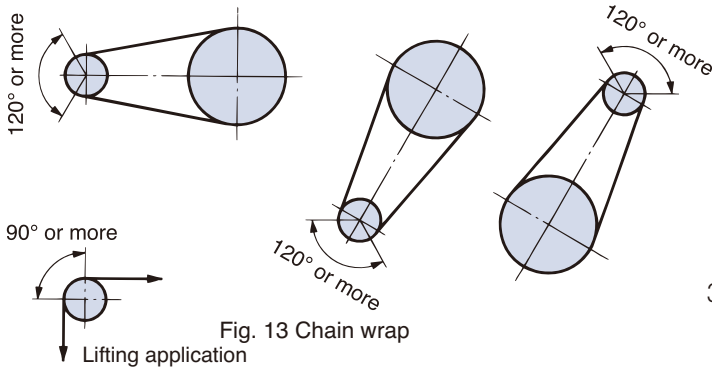

4.2 Distance between shafts

The minimum distance can be as short as desired as long as the teeth of the two sprockets are not in contact. The optimum center-to-center distance between the shafts is 30 to 50 times the pitch of the roller chain. However, if the load is variable, a distance of 20 times or less is suitable.

4.3 Amount of slack

1) Unlike V or flat-belt transmission, there is no need to apply an initial tension in roller chain transmission; roller chain is normally used with a suitable amount of slack. If too much tension is applied to roller chain, the oil film between the pins and bushes will break, causing increased wear and damage on the roller chain and bearings. If there is too much slack in the roller chain, the chain will vibrate and ride up the sprocket, damaging both chain and sprocket.

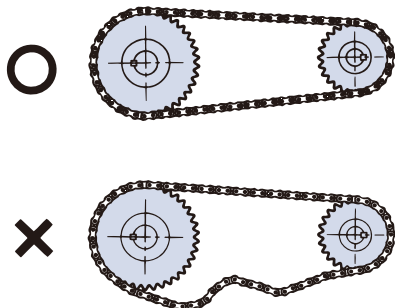

2) If possible, the lower side should be the slack side in roller chain transmission. The amount of slack is appropriate when the distance (SS') that the chain can be moved per-pendicularly by hand at the center of the slack side is 4% of the span (AB). (For example, when the span is 800 mm, the amount of slack should be $800 \text{ mm} \times 0.04 = 32 \text{ mm}$.)

In the following situations, this should be 2%:

- 1) When the transmission is vertical or close to vertical (a tensioner is required).
- 2) When the distance between the shafts is more than 1 m.
- 3) When frequent starts are made with a heavy load.
- 4) When sudden reverse motion takes place.

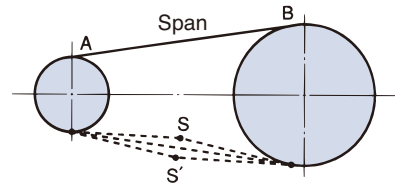

Fig. 14 Amount of slack

- 3) Roller chain will stretch slightly during the first few dozen hours of use as the contact surfaces wear in (about 0.05%). This may result in too much slack in the roller chain and may require adjustment of the slack. A tensioner can be used if the layout is designed for it. If you do not have a tensioner, move the shafts to adjust the amount of slack. Once the chain is worn in, very little stretching will occur.

4.4 Horizon precision and parallelism of the shafts

The installation precision of the sprocket has a large effect on the smoothness of roller chain transmission. It also affects roller chain life.

Install the sprockets correctly as described below.

- 1) Verify Horizontal precision with a level. Adjust the precision to within $\pm 1/300$.

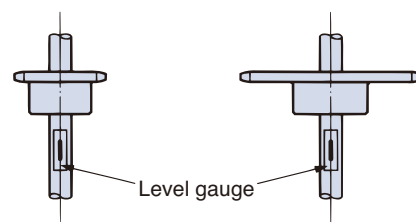

Fig. 15 Horizontal precision

- 2) Use a scale to correct the degree of parallelism of the shafts. Adjust the shafts so that they are parallel to within $\pm 1/300 = (A-B/L)$.

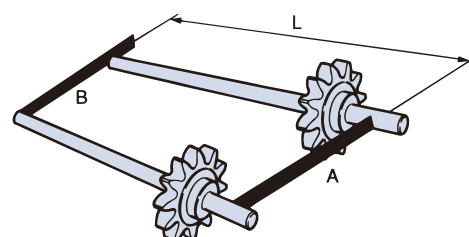

Fig. 16 Degree of parallelism of the shafts

3) Using a straightedge (or a scale), adjust the two sprockets so that they are parallel. Adjust to within the following values based on the distance between the shafts.

- Up to 1 m : ± 1 mm
- 1 m to 10m : ± $\frac{\text{Distance between shafts(mm)}}{1,000}$
- 10m or more : ± 10 mm

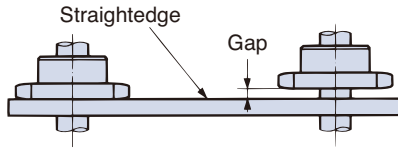

Fig. 17 Sprocket misalignment

4) Secure each sprocket to the shaft with a power lock, lock sprocket, or key (if needed use a collar, set bolt, etc.).

4.5 Layout (◐ indicates the driver side in the illustrations)

1) General layout

Ideally, the line connecting the sprocket centers in the roller chain transmission equipment should be close to level. In a layout that is close to vertical, the roller chain may stretch and fall off the sprocket. Thus, an idler or tensioner should be used. If possible keep the angle of inclination within 60°.

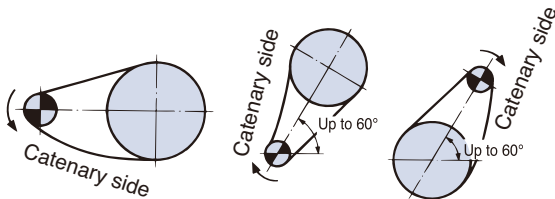

Fig. 18 General layout

2) Layouts requiring caution

(1) When the slack is on the upper side

When the center-to-center distance between the shafts is short, move the shafts to adjust the distance and slightly increase the tension.

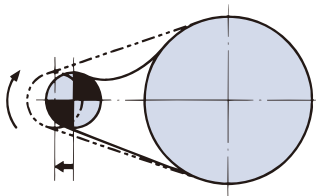

Fig. 19 Layout when the center-to-center distance is short

When the center-to-center distance is long, insert an intermediate idler under the slack part to support the roller chain.

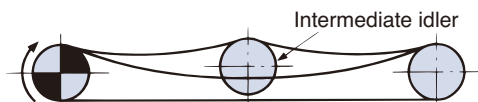

Fig. 20 Layout when the center-to-center distance is long

(2) When the chain speed is fast and the load varies Roller chain may vibrate if the natural vibration frequency of the chain, shock frequency of the driven machine, or chordal action of the chain (vertical pulsation of the chain due to the polygon effect) synchronize. In this event, use a guide shoe (made of NBR or ultra-high polymer polyethylene) or other device to stop the vibration.

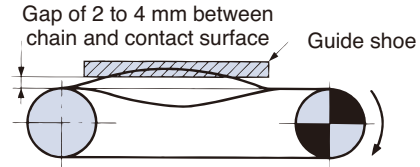

Fig. 21 Guide shoe to prevent vibration

(3) When the centerline is vertical Install a tensioner that can automatically eliminate excess slack. This is particularly necessary when the drive shaft is on the bottom.

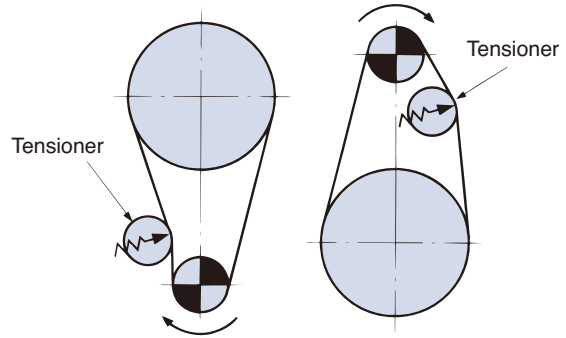
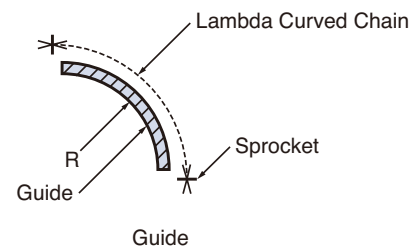

Fig. 22 Vertical transmission

4.6 Lambda Curved Chain installation

1) Installing the guide

Compared to a standard chain, a Lambda Curved Chain has a larger gutter between the pins and bushes, providing a greater degree of freedom. For this type of chain, please install a guide on the chain so that it engages straight onto the sprocket.



2) Minimum lateral bending radius (r)

Please manufacture the guide so that its minimum lateral bending radius is equal to or greater than the specifications shown below.

Chain no.	Minimum lateral bending radius (r)
RS40-LMC-CU-I	400
RS50-LMC-CU-I	500
RS60-LMC-CU-I	600

Handling Roller Chains and Sprockets

5. Sprockets

5.1 Hardening the teeth

When a sprocket is used under the following conditions, the sprocket teeth must be hardened.

- 1) When there is a small number of teeth (24 or less), and the speed is 1/8 or higher of the maximum rotation speed indicated on the kilowatt ratings tables.
- 2) When using small sprockets with a speed ratio of greater than 4:1.
- 3) When a large load is used at low speed (when using the Low-Speed Selection Method).
- 4) When using under conditions that will cause the teeth to wear.

5.2 Number of teeth

As many teeth as possible should be used on the sprocket on the high-speed shaft side to help ensure smooth drive transmission. Generally, 15 or more teeth should be used. However, when the speed ratio is high and the number of teeth on the low-speed sprocket exceeds 120, chain engagement problems can occur when there is even slight chain wear. In this case, decrease the number of teeth on the high-speed sprocket, but the number of teeth should still be kept to 13 or higher. However, if the sprocket will be used at extremely low speed and not subjected to shock, a sprocket with 12 or fewer teeth can be used.

5.3 Precautions related to additional processing

1) Shaft bore processing

① Maximum shaft bore processing dimensions

The maximum finished shaft bore size should be at or below the size shown in the specifications for each model number. Please contact a Tsubaki representative if using standards other than the JIS standards key.

② Finishing standards

When finishing, verify the standards for the tooth outer diameter ("D_o" in the diagram) and the hub outer diameter ("D_H" in the diagram).

Also, verify that the deflection on the tooth root ("a" in the diagram) and the deflection on the end surface of the tooth ("b" in the diagram) are at or below the values shown below.

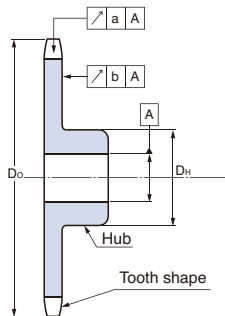

When using machine specifications

Diameter of tooth root cylinder	90 or less	> 90 but ≤ 190	> 190 but ≤ 850	> 850 but ≤ 1180	Greater than 1180
Deflection at tooth root a	0.15	0.0008d _r ±0.08		0.76	
Face runout	0.25		0.0009d _r ±0.08		1.14

2) Sprocket welding

When welding a hub to Type A sprockets for use, the welding can cause deformation or deflection of the tooth and surface, making it impossible to maintain product quality. As such, welding should be avoided. With Type A Strong Series sprockets, welding can also decrease the hardness of the sprockets, so again, welding should be avoided.

3) Processing on the hub outer diameter

Do not perform any additional processing to the outer diameter of the hub. If processing needs to be performed, please first contact a Tsubaki representative.

New JIS key (Table 5)

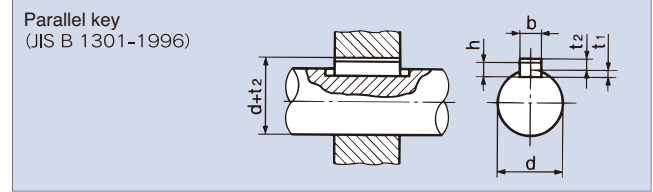

Shaft bore diameter d	Designated key diameter Shaft × Height b × h	Keyway depth		
		Shaft t ₁	Boss d+t ₂	
6 or higher	8 or lower	2×2	1.2	d+ 1.0
8	10	3×3	1.8	d+ 1.4
10	12	4×4	2.5	d+ 1.8
12	17	5×5	3.0	d+ 2.3
17	22	6×6	3.5	d+ 2.8
20	25	(7×7)	4.0	d+ 3.0
22	30	8×7	4.0	d+ 3.3
30	38	10×8	5.0	d+ 3.3
38	44	12×8	5.0	d+ 3.3
44	50	14×9	5.5	d+ 3.8
50	55	(15×10)	5.0	d+ 5.0
50	58	16×10	6.0	d+ 4.3
58	65	18×11	7.0	d+ 4.4
65	75	20×12	7.5	d+ 4.9
75	85	22×14	9.0	d+ 5.4
80	90	(24×16)	8.0	d+ 8.0
85	95	25×14	9.0	d+ 5.4
95	110	28×16	10.0	d+ 6.4
110	130	32×18	11.0	d+ 7.4
125	140	(35×22)	11.0	d+11.0
130	150	36×20	12.0	d+ 8.4
140	160	(38×24)	12.0	d+12.0
150	170	40×22	13.0	d+ 9.4
160	180	(42×26)	13.0	d+13.0
170	200	45×25	15.0	d+10.4
200	230	50×28	17.0	d+11.4
230	260	56×32	20.0	d+12.4
260	290	63×32	20.0	d+12.4
290	330	70×36	22.0	d+14.4
330	380	80×40	25.0	d+15.4
380	440	90×45	28.0	d+17.4
440	500	100×50	31.0	d+19.5

Note: The nominal dimensions shown in parentheses are not defined in international standards.

Old JIS key (Table 6)

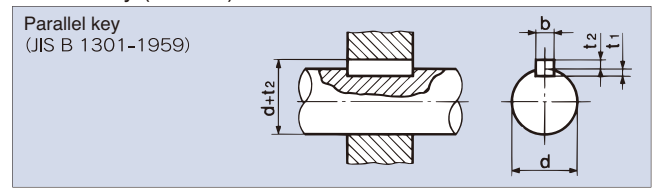

Shaft bore diameter d	Designated key diameter Shaft × Height b × (t ₂ × t ₁)	Keyway depth		
		Shaft t ₁	Boss d+t ₂	
10 or higher	13 or lower	4×4	2.5	d+ 1.5
13	20	5×5	3.0	d+ 2.0
20	30	7×7	4.0	d+ 3.0
30	40	10×8	4.5	d+ 3.5
40	50	12×8	4.5	d+ 3.5
50	60	15×10	5	d+ 5
60	70	18×12	6	d+ 6
70	80	20×13	7	d+ 6
80	95	24×16	8	d+ 8
95	110	28×18	9	d+ 9
110	125	32×20	10	d+10
125	140	35×22	11	d+11
140	160	38×24	12	d+12
160	180	42×26	13	d+13
180	200	45×28	14	d+14
200	224	50×31.5	16	d+15.5
224	250	56×35.5	18	d+17.5

6. Chain Test Run

After installing the chain, carry out a test run and check the following items before you actually start running the chain.

6.1 Pre-test Run

- 1) Connecting link plates, clips, and cotter pins are installed correctly.
- 2) Chain slack has been properly adjusted.
- 3) Adequate lubrication is available.
- 4) The chain is not touching the chain case.
- 5) The roller chain path is clean and free from obstructions.

6.2 Test Run

- 1) There should be no strange noises. Make sure the chain does not touch the case.
- 2) Look for excessive chain vibration.
- 3) Make sure the chain does not run up on the sprockets.
- 4) Ensure that the chain is not jammed into the sprockets.
- 5) The chain should articulate smoothly.

Check the inspection checklist if there are any problems, and ensure roller chain and sprocket are correctly installed.

7. Roller Chain Inspection

- 1) In general, roller chain life is said to be reached when parts are damaged or when 1.5% wear elongation occurs. See 6) in 7.3. Try to replace the chain before these conditions occur.
- 2) If roller chain selection and operating conditions are suitable, you can expect rather long life with no unexpected trouble from the chain. However, wear will progress between the pins and bushes after long periods. The following should be noted and inspected.

7.1 Inspection Checklist (Table 7)

Procedures	Method	Inspection items	Reference page for details
Step I	Visually check the chain during operation and look for any abnormalities.	<ol style="list-style-type: none"> 1. There should be no strange noises. 2. Look for excessive chain vibration. 3. Make sure the chain does not run up on the sprockets. 4. The chain is not jammed into the sprockets. 5. There are no stiff areas during articulation. 6. Adequate lubrication is available (lubricating system and quantity of oil). 7. Make sure the chain doesn't touch the case. 	Inspection points are on the following pages and on the troubleshooting pages.
Step II	Stop the chain and carefully inspect each part of the chain and sprocket.	<ol style="list-style-type: none"> 1. Check the external cleanliness, corrosion, and lubrication conditions; also, look for scratches or other damage to the plate side and edge surfaces, pin edges, and roller surfaces. 2. Inspect for pin rotation and inspect the clearance between plates and pins. 3. Inspect the sprocket teeth surfaces and teeth side surfaces for scratches or marks. 4. Measure the wear elongation of the chain. 5. Check the articulation of the chain and rotation of the rollers. 6. When using an end fitting for lifting applications, inspect the wear of the end bolts and the wear of the connecting plate pins. Also, check for proper installation at the same time. 	
Step III	In order to investigate in more detail, remove the roller chain and inspect it visually or check it with measuring instruments.	<ol style="list-style-type: none"> 1. The inspection items are identical to those in Step II except in more detail. 	

Handling Roller Chains and Sprockets

7.2 Inspection intervals

Regular inspection of roller chain is recommended at one month intervals. Inspection should be carried out at shorter intervals in:

- 1) Special or corrosive environments.
- 2) High speeds with sudden stoppage.
- 3) Lifting or indexing operations.

7.3 Inspection requirements for ordinary transmission

1) Inspection lubrication conditions

- ① During operation, check to see if there is lubrication in the clearance between the outer plate and inner plate. Also, check if the chain or rotating disc is immersed in lubricating oil.
- ② When the chain is stationary, the chain surface will generally appear dirty from wear dust if lubrication is unsatisfactory. This is especially the case between the link plates.
- ③ When the chain is removed, connecting link pins and the edge of the inside of the bushes should be checked. If there are any scratches, or red or reddish-brown coloration, lubrication is improper or insufficient.

2) Inspecting link plates

- ① If repeat loads over the maximum allowable load are put on the chain, there is a strong possibility of fatigue breakage of the link plates. It is difficult to notice initial cracking from fatigue breakage simply from external observation.
- ② Usually, a crack develops at the edge of a hole or at the side of the link plate, as shown in the illustrations below. The presence of cracks should be checked carefully. Fatigue breakage progresses little by little, so it can be noticed with close attention.

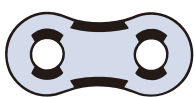

Positions where cracks are likely to develop



Example of a crack

Fig. 23 Cracks on the link plates

- ③ When wear occurs from sliding between the edges of the plates and the guides, it is necessary to adjust the position of either the chain or the guides. The allowable wear on the link plates is limited to 5% of their height.

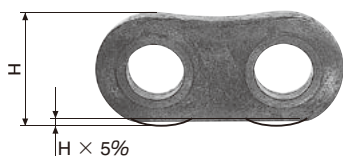
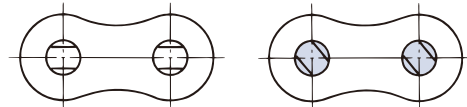

Fig. 24 Wear on the edges of the link plates

3) Inspecting Pins

When the pins rotate, the roller chain must be completely replaced with new chain. This also applies to the connecting pins. By removing the connecting parts it is possible to see the conditions of wear and rust on the surfaces of the pins.



Correct position

Rotated position

Fig. 25 Rotation of the pins

4) Inspecting rollers

- ① As with the link plates, if rollers are also subjected to loads over the maximum allowable load, the repeated impact load between the chain and the sprockets may cause fatigue breakage to occur. The roller should be checked in the same way as the link plate.
- ② If foreign objects interfere with the engagement of the roller and sprocket, the roller may be damaged and a crack may develop. Careful attention should be paid to the above. Furthermore, with high-speed operations, even if foreign objects do not interfere with engagement, cracks may appear from the impact with the sprocket teeth.



Fig. 26 Cracks on the rollers

- ③ Chains damaged by fatigue breakage from the rollers must be completely replaced, as each part has received the same amount of repeated load.
- ④ Also check for poor roller rotation.

5) Inspecting sprockets

- ① Chain and sprocket engagement can be checked by observing the roller and teeth surface. Proper engagement is when the contact area is uniform with point A in the illustration. If the contact area is lopsided or the sides of the teeth are wearing away (point B), this may have been caused from improper installation of the sprockets or twisting of the roller chain. In this case, rechecking/readjustment is necessary.
- ② The normal point of impact is slightly up from the tooth root. However, when initial tension is applied to the chain and tension remains on the slack side, the roller will slightly touch the tooth root. However, point A receives the strongest impact.

- ③ When idlers or tensioners are used, the contact area will be the center of the tooth root.

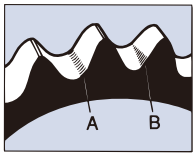

B: Improper installation

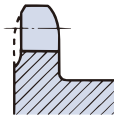

Improper installation causes the surface of the teeth to become ground down

Fig. 27 Contact area of the sprocket teeth

- ④ When wear on the teeth reaches the values in the following table, the lifespan of the sprocket has been reached. For a sprocket with induction hardened teeth, the lifespan is reached when the hardened layer has been removed.

Limit of usage based on tooth thickness/Dimension B (Table 8)

Size of RS Roller Chain	Dimension B		Size of BS Roller Chain	Dimension B Normal
	Normal	Pin-Gear		
RS 11-SS-1	0.6	—	RF06B-1	1.6
⌀ 15-1	1.1	—	RS08B-1	2.1
⌀ 25-1	1.5	—	⌀ 10B-1	2.9
⌀ 35-1	2.5	—	⌀ 12B-1	3.6
⌀ 41-1	2.6	—	⌀ 16B-1	5.0
⌀ 40-1	2.5	3.1	⌀ 20B-1	6.8
⌀ 50-1	2.9	3.6	⌀ 24B-1	7.2
⌀ 60-1	3.7	4.6	⌀ 28B-1	8.6
⌀ 80-1	5.0	6.3	⌀ 32B-1	11.9
⌀ 100-1	6.9	8.6	⌀ 40B-1	12.7
⌀ 120-1	8.7	10.9		
⌀ 140-1	10.6	13.3		
⌀ 160-1	12.4	15.5		
⌀ 180-1	11.3	14.1		
⌀ 200-1	12.6	15.8		
⌀ 240-1	15.1	18.9		
RF320-T-1	19.9	24.9		
RF400-T-1	24.9	31.2		

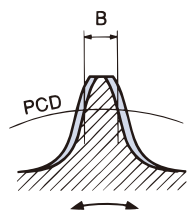

Forward and reverse

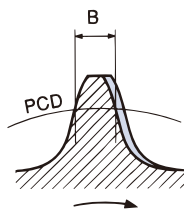

One direction

- ⑤ If a new roller chain is run on a worn sprocket, the chain will wear at a faster rate than normal. In this case, when replacing the chain, replacement of the sprocket is also recommended.

6) Inspection of chain elongation

- ① Chain elongation is caused not by deformation of the link plate, but by wear on the pin and bush. Therefore, the remaining chain life can be estimated by periodically measuring the chain elongation.

② Measuring chain elongation

- The chain should be measured whilst stretching it slightly to eliminate any slack.
- Measure the distance of the inside (L_1) and outside (L_2) of the rollers at both ends of the measured links using a vernier caliper to get measurement (L).

$$L = \frac{L_1 + L_2}{2}$$

- When measuring, use at least 6 to 10 links to help keep any measuring error down to a minimum.

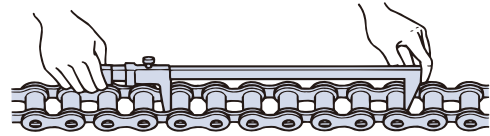

Positioning of vernier calipers for measuring 6 links

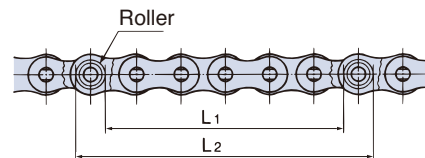

Fig. 28 Measuring length

(4) Finding chain elongation

$$\text{Chain elongation (\%)} = \frac{\text{Measured length} - \text{Standard length}}{\text{Standard length}} \times 100$$

$$\text{Standard length} = \text{Chain pitch} \times \text{Number of links}$$

- For multi-strand roller chain, the measurement is carried out in the same way as for single strand roller chain of the same pitch.
- The limit of usage based on roller chain elongation for a smooth transmission is as follows.

Limit of usage based on elongation (table 9)

Large sprocket with up to 60 teeth	Chain elongation 1.5%
Large sprocket with between 61 - 80 teeth	Chain elongation 1.2%
Large sprocket with between 81 - 100 teeth	Chain elongation 1.0%
Large sprocket with between 101 - 110 teeth	Chain elongation 0.8%

Handling Roller Chains and Sprockets

- (7) Dimensions for evaluating standard length (chain pitch x number of links) and 1.5% elongation are shown in Table 10 below.
- (8) When the length of the roller chain cannot be measured with calipers, a tape measure may be used; however, measurements need to be taken over as many links as possible to reduce measuring error.
- (9) When chain elongation of Lambda/X-Lambda Roller Chain reaches about 0.5% it may be losing its lubricating properties. This may be determined by the adhesion of red wear particles between the plates and the occurrence of articulation stiffness. When this occurs, the life of the chain has been reached.

- 4) Inspect for twisting and side bending of the roller chain. If partial twisting or side bending of the chain occurs, the complete roller chain should be replaced. (Fig. 29)

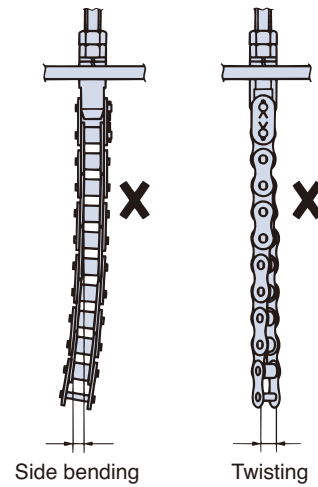

Fig. 29 Twisting of the roller chain

Standard Length and 1.5% Elongation (Table 10)

Chain No.		RS25	RS35	RS41	RS40
6 links measured	Standard length	38.10	57.15	76.20	76.20
	1.5% elongation	38.67	58.01	77.34	77.34
10 links measured	Standard length	63.50	95.25	127.00	127.00
	1.5% elongation	64.45	96.68	128.91	128.91

Chain No.		RS50	RS60	RS80	RS100
6 links measured	Standard length	95.25	114.30	152.40	190.50
	1.5% elongation	96.68	116.01	154.69	193.36
10 links measured	Standard length	158.75	190.50	254.00	317.50
	1.5% elongation	161.13	193.36	257.81	322.26

Chain No.		RS120	RS140	RS160	RS180
6 links measured	Standard length	228.60	266.70	304.80	342.90
	1.5% elongation	232.03	270.70	309.37	348.04
10 links measured	Standard length	381.00	444.50	508.00	571.50
	1.5% elongation	386.72	451.17	515.62	580.07

Chain No.		RS200	RS240
6 links measured	Standard length	381.00	457.20
	1.5% elongation	386.72	464.06
10 links measured	Standard length	635.00	762.00
	1.5% elongation	644.53	773.43

- 5) End fittings
Check for damage by deformation of the hole due to wear. If the hole is damaged or deformed, replace the end bracket immediately. The clearance on the pinhole of the bracket affects the life of the roller chain and should be kept to a minimum

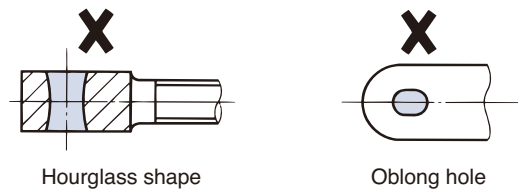

Fig. 30 Wear on the end fitting hole

7.4 Inspection of lifting and shuttle traction

- 1) This should be carried out with the same requirements as for ordinary transmission shown in item 6.3.
- 2) It is important to check the lubrication of the connecting parts between the roller chain and end brackets where end brackets are installed, as well as the parts where the roller chain winds around the sprocket. (Refer to item 3.2 on page 192.)
- 3) The parts where the roller chain bends around the sprocket should be checked when inspecting the wear elongation of the roller chain.

7.5 Storage

Avoid storing spare parts, such as roller chains, sprockets, and end brackets, in high temperature/high humidity and dusty environments. Also, when storing roller chain that has been removed, wash the roller chain and then apply lubrication. After the roller chain clearances have been supplied with a sufficient amount of lubricant, wrap the chain in grease paper completely before storing away.

8. Cautions on Use in Special Environments

As a general rule, roller chain should be used in a clean air flow; however, when used in special atmospheres, refer to the various items that follow.

8.1 Use in wet conditions

If the chain is used in a sterilizing machine or water screen, for example, where the chain is splashed with water or goes through heated vapor, the following problems may occur.

- 1) An increase in wear elongation due to improper or insufficient lubrication.
- 2) Decrease in fatigue strength from rust and corrosion (pitting) of the chain.
 - 1) Countermeasures
 - (1) Reduce bearing pressure by using a larger sized chain to improve wear resistance.
 - (2) Use corrosion resistant roller chain for rust prevention.

8.2 Use in acidic or alkaline conditions

If roller chain is exposed to acidic or alkaline conditions, such as battery acid and liquid used in plating processes, the following problems may occur.

- 1) Embrittlement fracture of link plates and pins.
- 2) Fatigue breakage of link plates and pins due to rust and pitting corrosion.
- 3) Wear from usual mechanical wear and corrosion.
- 4) Reduction in volume of the whole chain from corrosion.
- 5) In special cases where the chain is underwater (immersed in liquid), electrochemical corrosion may occur.
- 6) There are also circumstances where even stainless steel roller chain will corrode. Fig. 31 shows an example of chain that was used in a plating apparatus. The chain fell to pieces within one month due to the effects of the acid.
 - 1) Countermeasures for embrittlement fractures (Stress corrosion cracking)
 - Adopt a brittleness countermeasure that lowers crack susceptibility.
 - Install a cover or casing to prevent acids or alkalis from contacting the chain.
 - Adopt a high-grade material with anti-corrosive properties.
 - 2) Countermeasures for corrosion
 - Use surface-treated chain.
 - Install a cover or casing to prevent acids or alkalis from contacting the chain.
 - Adopt a high-grade material with anti-corrosive properties.

In general, embrittlement fractures (stress corrosion cracking) occur around link plate holes. This is the area where the pin and bush are press-fitted to the link plate, and with the highest concentration of stress. Cracks are generated even when there is no tension on the chain. Roller chain in general is more susceptible to acids than alkalis, and in special cases, embrittlement fractures (stress corrosion cracking) are generated by seawater or pit water.

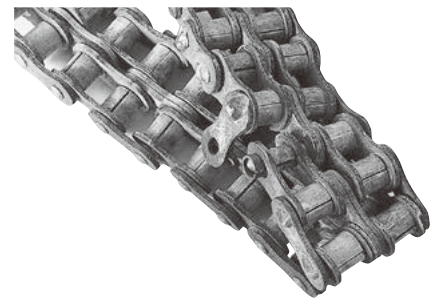

Fig. 31 Corrosion of stainless steel roller chain



Fig. 32 Hydrogen embrittlement cracking

8.3 Use under conditions where wear is a problem

If the chain is exposed to highly abrasive materials that promote wear such as sand, coke, and metal particles, the following problems may occur:



- 1) When abrasive materials penetrate between the pins and bushes, chain wear is promoted and poor articulation occurs.
- 2) When abrasive materials penetrate between the bushes and rollers, chain wear is promoted and poor roller rotation occurs.
- 3) When the abrasive materials penetrate between the link plates, poor articulation occurs.
 - 1) Countermeasures
 - Install a protective casing against dust.
 - Remove foreign particles by regularly washing the roller chain.
 - Reduce bearing pressure by using a larger sized chain to improve wear resistance.
 - Increase wear resistance by applying special processing to the parts of the chain where wear is a problem.

Handling Roller Chains and Sprockets

9. Roller Chain Drive Troubleshooting and Problem Solving

When there is significant damage and breakage to the roller chain and sprockets, please carry out the following remedies and replace with new chain and sprockets as necessary.

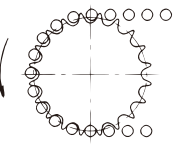

9.1 General

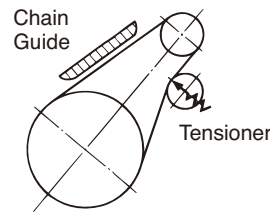
Symptom	Possible Causes	Remedy
 <p>Chain is riding up on the sprocket.</p>	The roller chain and sprocket do not match.	Replace the chain or sprocket with the correct size.
	Excessive load.	Decrease the load, or increase the number of strands or size of the chain.
	Elongation of the chain due to wear or excessively worn sprocket teeth.	Replace with new chain and sprockets.
Unusual noises.	Improper installation of the sprocket or shaft.	Inspect and correct.
	Chain casing or bearings are loose.	Tighten all bolts and nuts.
	Excessive or insufficient slack in the chain.	Adjust the distance between shafts to obtain the proper amount of slack.
	Excessively worn chain or sprocket.	Replace the chain and sprocket with new chain and sprocket.
Excessive vibrations in chain.	Lack of or unsuitable lubrication.	Provide proper lubrication according to the operating conditions.
	Chain is resonating with periodic external force.	Change the chain's mode of vibration. <ol style="list-style-type: none"> 1. Preventing resonance. <ol style="list-style-type: none"> a. Change the natural frequency of the chain. <ul style="list-style-type: none"> • Alter the effective tension either by applying an initial tension or adjusting the existing one. • Install a tensioner to change the chain span. • Replace the chain. Choose a different mass and spring coefficient. b. Change the vibration frequency. <ul style="list-style-type: none"> • Change the speed of rotation of the sprocket. • Re-evaluate the device set-up. 2. Mechanically reducing the vibrations. <ul style="list-style-type: none"> • Install a guide shoe. • Install a self-adjusting tensioner on the slack side.
Load fluctuations are excessively large.	Reduce fluctuations with a fluid coupling or similar technique.	
 <p>The chain winds onto the sprocket. (Poor separation from the sprocket teeth)</p>	Span between shafts is too large.	Install an idler.
	Excessive slack in chain.	Adjust the chain length or distance between shafts. Install a tensioner.
	Elongation of the chain due to chain wear or excessively worn sprocket teeth.	Replace with new chain and sprocket.

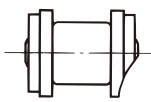

Before Use | Standard Roller Chains | Lube-Free Roller Chains | Heavy Duty Roller Chains | Corrosion Resistant Roller Chains | Specialty Roller Chains | Sprockets | Pin Gear Drives | Accessories | Selection

Handling

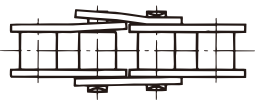
Symptom	Possible Causes	Remedy
Rusting of the chain.	Improper lubrication or poor environment.	Replace chain and protect it from the environment with chain casing or proper lubrication.
Excessive wear on the inside surface of the link plates and sides of the sprocket teeth.	Improper installation. 	Correct sprocket and shaft installation.
Excessive wear on the link plate side surfaces and pin heads.	Improper installation of guides, etc. 	Check the condition of the guides, and increase the gap between the guides and the chain.
 Improper flex or bending of chain, tight joints.	Chain is not installed correctly.	Inspect the installation and correct as necessary.
	Contamination from wear debris or dirt because of improper lubrication.	Remove the chain, clean it thoroughly, and provide proper lubrication.
	Excessive load, pin bending, or bush cracking.	Reduce the load or increase the number of or size of chains. Replace chain with a larger size.
	Corrosion or rusting.	Install a chain casing to protect the chain.
	Seizing from improper lubrication.	Provide proper lubrication according to the operating conditions.
	Seizing of pin and bush.  Pins and bushes may seize due to high speed operation, causing poor articulation and leading to chain breakage.	Provide the proper operating conditions.
Spreading of link plates.	Uneven or excessive loading caused by improper installation. 	Replace with new chain and correct installation.

Handling Roller Chains and Sprockets

9.2 Link Plate Related

Symptom	Possible Causes	Remedy
Breakage of link plate.	Excessively large shock load.	Reduce shock loads by making the start-up, stopping, and other actions smoother (installing a shock absorber, etc.). Increase the size or number of chains.
	Vibration in the chain.	Install an anti-vibration device (for example, a tensioner or idler). Refer to the section on excessive chain vibration.
	Large inertia in the driven machine. (excessive load)	Increase the size or number of chains.
	Corrosion.	Replace with a new chain. Install a casing to protect the chain. Periodically clean the chain.



① Static fracture
Pulling the link plate with a tensile load beyond its breaking load will cause it to stretch and then break.



② Fatigue fracture
By repeatedly applying a load past its fatigue limit (fatigue strength), the fatigue will start at holes and then cause sudden chain breakage.

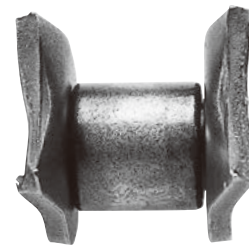

③ Offset link plate fatigue
Offset link plates are bent at the center, and the resulting concentration of stress at the bend can cause a fatigue break. Avoid using offset links in high-stress applications.

Cracks in the link plates (fatigue), which are perpendicular to the direction of pull.	Load is are greater than the allowable load.	Remove all large or excessive repeat loads. Otherwise, increase the size or number of chains. Replace with a new chain.
Deformation of link plate holes.	Excessive load.	Remove the cause of the excessive load. Replace with a new chain.
Corrosion stress cracks appear, usually as bow-shaped cracks in the link plate.	The chain is being used in an acidic or alkaline enviroment. (This is not caused by a repetitive load.)	<ul style="list-style-type: none"> Replace with a new chain. Install a casing to protect the chain from the environment. Consider a chain with a high resistance to corrosion stress cracks. (Please contact a Tsubaki representative.)

Before Use | Standard Roller Chains | Lube-Free Roller Chains | Heavy Duty Roller Chains | Corrosion Resistant Roller Chains | Specialty Roller Chains | Sprockets | Pin Gear Drives | Accessories | Selection | Handling

9.3 Pin Related

Symptom	Possible Causes	Remedy
Breakage of pin.	Large shock loads.	Reduce shock loads by making the start-up, stopping, and other actions smoother.
	Subject to a repetitive load greater than the fatigue limit of the pin.	Remove the large repetitive load. Otherwise, increase the size or number of chains.
	Corrosion.	Install a casing to protect the chain. Periodically clean and lubricate the chains.

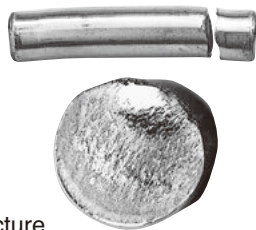

① Static fracture
The type of fracture found when subjecting the chain to the breakage test. Occurs when chain is subjected to a load greater than its breakage strength.

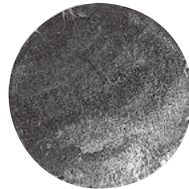



② Fatigue fracture
Occurs when the pin is repetitively subjected to loads greater than its fatigue limit. Re-check the size of the peak load and formulate a countermeasure.

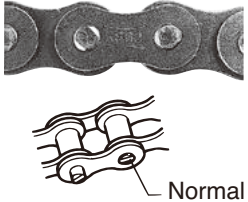

③ Shock-induced bending fracture
The pin is subjected to a large shock load and breaks. The side with the initiating point receives tensile load, and the fracture progresses from this point. A pin is especially susceptible to becoming weak with regard to bending when the surface of the pin has corroded. This type of phenomenon occurs quite easily.

Pin rotates or begins to stick out.	Excessive load or improper lubrication.	Replace with new chain. Improve the lubrication or loading conditions.
	Operating a chain at high load without proper lubrication can create friction between the pin and bush, causing the pin to rotate. In this situation, the pin may come out, leading to chain breakage.	Replace with new chain immediately. Do not weld or reuse the pins. (Dispose of the old chain to be sure that it is not used again by mistake.) Also, if the pin head or link plate surface is worn, check the installation.
Wear or rust occurs only at the connecting pin in a lifting application or similar operation.	Improper initial lubrication during installation.	Replace the connecting link. If pin wear is excessive, replace the chain also. Take special care to properly install the connecting section for devices such as end brackets used for lifting applications, etc.

9.4 Bush / Roller Related

Symptom	Possible Causes	Remedy
Roller and/or bush splits (falls off).	Excessive load or speed of rotation.	Choose a different chain according to the kW ratings table.
	Inadequate lubrication.	Replace the chain. Provide adequate lubrication according to the operating conditions.
Roller does not rotate.	 Fatigue fracture. Reached the point of fatigue during operation and eventually broke. Occurs when there is impact with the sprocket teeth at a force exceeding the chain's transmission capacity.	
	RS11-SS-1, RS15-1, RS25-1, RS35-1	A bushed chain and not a roller chain is being used.
	The inner link plate is moving inward, or the bush is cracked.	Replace with a new chain. Re-inspect the installation and load conditions.
Roller is opening up.	Foreign particles have gotten between the bush and roller.	Periodically clean the chain. Install a casing to protect the chain.
	Excessive load. 	Reduce the load. Provide adequate lubrication.
Roller is becoming hourglass shaped.	Excessive load or inadequate lubrication.	Replace with new chain. Improve the lubrication or loading conditions.

Handling Roller Chains and Sprockets

Roller Chain and Sprocket Inquiry Sheet (for new installation or replacement)

Enter information for items 1 – 3 if known.				1	Chain number
2	Sprocket no. of teeth (drive x driven)			3	Number of links
4	Machine used			5	Type of impact (load fluctuation) Smooth Moderate impact Large impact
6	Do you have fluid couplings?	Yes	No	7	Motor type
8	Motor rated output			9	Motor rated torque
10	Motor rated RPM			11	Reduction gear ratio of reducer
12	RPM of reducer output shaft			13	Reducer output shaft allowable torque
14	RPM of driven shaft			15	Shaft diameter (drive shaft x driven shaft)
16	Distance between shafts			Provide the RPM of the motor used and a torque diagram when the RPM is controlled by frequency (inverter, etc.).	
17	Frequency of starting (stopping)	times/day (8hrs/day)		*Complete item 18 if starting (stopping) frequency is more than 6 times or more a day. Skip to item 26 if less than 6 times a day.	
18	Are there soft starts/stops?	Yes	No	*Complete items 19 and 20 if there are soft starts/stops, otherwise skip to item 21.	
19	Acceleration (acceleration time)			20	Deceleration (deceleration time)
21	Moment of inertia or GD ² of motor (circle one)			22	Converted moment of inertia or GD ² of motor shaft load (circle one)
23	Starting torque of motor			24	Maximum (stalling) torque of motor
25	Braking torque				
26	Atmosphere	Temp (°C)	Abrasive dust (Yes / No)	Corrosive liquid or gas (Yes / No)	
27	Simple diagram of layout from motor to chain/sprocket section			*Provide the conveyor specifications if this is for a conveyor drive. Include a diagram of the layout that includes conveyed load, speed, sprocket PCD, distance between shafts, etc. as well as the load torque.	

Company name	
Your name	TEL
Date	FAX

Before Use
 Standard Roller Chains
 Lube-Free Roller Chains
 Heavy Duty Roller Chains
 Corrosion Resistant Roller Chains
 Specialty Roller Chains
 Sprockets
 Pin Gear Drives
 Accessories
 Selection



WARNING

Obey the following points in order to prevent hazardous situations.

- Do not use chains and accessories (accessories and parts) for anything other than their original purpose.
- Never perform additional processing on the chain.
 - Do not anneal the various parts of the chain.
 - Do not clean the chain with either acid or alkali, as they may cause cracking.
 - Do not electroplate the chain or its parts, as it may cause cracking due to hydrogen embrittlement.
 - Do not weld the chain, as the heat may cause cracking or a reduction in strength.
 - When heating or cutting the chain with a torch, remove the links immediately adjacent and do not use them again.
- When there is need to replace a lost or damaged portion of a chain, always replace the whole chain with a new product rather than replacing only the lost or damaged portion.
- When using a chain on suspension equipment, establish a safety perimeter and strictly prevent entry to the area directly below the suspended object.
- Always employ hazard protection devices for the chain and sprocket (safety cover, etc.).
- If a substance that can cause embrittlement cracking (acid, strong alkali, battery fluid, etc.) adheres to the chain, stop using the chain immediately and replace it with a new one.
- During installation, removal, maintenance inspection and lubrication of the chain:
 - Perform the operation according to the instruction manual or this catalog.
 - Always turn off the power switch to the device and make sure that it cannot be turned on accidentally.
 - Anchor the chain and parts so that they cannot move freely.
 - Perform cutting and connecting procedures properly using a press or other special tool.
 - Wear clothing and employ protective devices that are appropriate to the job (safety glasses, gloves, safety shoes, etc.).
 - Only allow experienced personnel to perform chain replacement procedures.
- A fail safe back up system is suggested whenever using Leaf Chain to safely support the load in the event of a chain failure.



CAUTION

Obey the following points in order to prevent accidents.

- Only handle the chain after thoroughly understanding its structure and specifications.
- When installing a chain, inspect it in advance to confirm that it has not been damaged in transport.
- Be sure to perform regular maintenance inspections on the chain and sprocket.
- Chain strength varies according to manufacturer. When selecting a chain based on a Tsubaki catalog, always use the corresponding Tsubaki product.
- Minimum tensile strength refers to the failure point when the corresponding load is applied to the chain once and does not refer to the allowable operational load.

Warranty

1. Products manufactured by Seller: (a) conform to the design and specifications, if any, expressly agreed to in writing by Seller; and (b) are free of defects in workmanship and materials at the time of shipment. The warranties set forth in the preceding sentence are exclusive of all other warranties, express or implied, and extend only to Buyer and to no other person. ALL WARRANTIES OF MERCHANTABILITY OR FITNESS FOR A PARTICULAR PURPOSE ARE HEREBY EXCLUDED.

NON-RELIANCE

2. Buyer is not relying upon any advice, representations or warranties (except the warranties expressly set forth above) of Seller, or upon Seller's skill or judgment regarding the Seller's products. Buyer is solely responsible for the design and specifications of the products, including without limitation, the determination of suitability for Buyer's application of the products.

CLAIMS

3. (a) Any claim relating to quantity or type shall be made to Seller in writing within 7 days after receipt of the products; any such claim made thereafter shall be barred.
 - (b) Any claim under the above-stated Limited Warranty shall be made to Seller in writing within three (3) months after receipt of the products; any such claim made thereafter shall be barred.
 - (c) Seller's liability for breach of warranty or otherwise is limited to repair or replacement, at Seller's option, of non-conforming or defective products. Buyer waives all other remedies, including, but not limited to, all rights to consequential, special or incidental damages, including, but not limited to, damages

resulting from personal injury, death or damage to or loss of use of property.

- (d) Repair, alteration, neglect or misuse of the products shall void all applicable warranties.

INDEMNIFICATION

4. Buyer will indemnify, defend and hold Seller harmless from all loss, liability, damage and expense, including attorneys' fees, arising out of any claim (a) for infringement of any patent, trademark, copyright, misappropriation of trade secrets, unfair competition or similar charge by any products supplied by Seller in accordance with the design or specifications furnished by Buyer, or (b) arising out of or connected with the products or any items into which the products are incorporated, including, but not limited to, any claim for product liability (whether or not based on negligence or strict liability of Seller), breach of warranty, breach of contract or otherwise.

ENTIRE AGREEMENT

5. These terms and conditions constitute the entire agreement between Buyer and Seller and supersede any inconsistent terms and conditions, whether contained in Buyer's purchase order or otherwise, and whether made heretofore or hereafter. No statement or writing subsequent to the date hereof which purports to modify or add to the terms and conditions hereof shall be binding unless consented to in writing, which makes specific reference hereto, and which has been signed by the party against which enforcement thereof is sought. Seller reserves the right to change these terms and conditions without prior notice.

The logos and product names appearing in this catalog are the trademarks and registered trademarks both in Japan and other countries of Tsubakimoto Chain Co. and affiliated Group Companies.

MEMO

A series of horizontal dashed lines for writing.



TSUBAKIMOTO CHAIN CO.

Japan	Headquarters	+81 6-6441-0011	http://tsubakimoto.com
-------	--------------	-----------------	---

Global Group Companies

AMERICAS

United States of America	U.S. Tsubaki Power Transmission, LLC	+1 847-459-9500	http://www.ustsubaki.com/
Brazil	Tsubaki Brasil Equipamentos Industriais Ltda.	+55 11-3253-5656	http://tsubaki.ind.br/
Canada	Tsubaki of Canada Limited	+1 905-676-0400	http://tsubaki.ca/

EUROPE

Netherlands	Tsubakimoto Europe B.V.	+31 78-6204000	http://tsubaki.eu/
France	Kabelschlepp France S.A.R.L.	+33 1-34846365	http://kabelschlepp.fr/
Germany	Tsubaki Deutschland GmbH	+49 89-2000-133-80	http://tsubaki.de/
	Tsubaki Kabelschlepp GmbH	+49 2762-4003-0	http://tsubaki-kabelschlepp.com/
Italy	Kabelschlepp Italia S.R.L.	+39 0331-350962	http://kabelschlepp.it/
Russia	OOO Tsubaki Kabelschlepp	+7 499-4180212	http://kabelschlepp.ru/
Spain	Tsubaki Ibérica Power Transmission S.L.	+34 911-873450	http://tsubaki.es/
United Kingdom	Tsubakimoto U.K. Ltd.	+44 1623-688-700	http://tsubaki.eu/

INDIAN OCEAN RIM

Singapore	Tsubakimoto Singapore Pte. Ltd.	+65 6861-0422/3/4	http://tsubaki.sg/
Australia	Tsubaki Australia Pty. Limited	+61 2-9704-2500	http://tsubaki.com.au/
India	Tsubaki India Power Transmission Private Limited	+91 44-7101-2000	http://tsubaki.in/
Indonesia	PT. Tsubaki Indonesia Trading	+62 21-89458898	http://tsubakimoto.co.id/
Malaysia	Tsubaki Power Transmission (Malaysia) Sdn. Bhd.	+60 3-8966-2020	http://tsubaki.my/
New Zealand	Tsubaki Australia Pty. Limited - New Zealand Branch	+64 9 352-2085	http://tsubaki.com.au/
Philippines	Tsubakimoto Philippines Corporation	+63 2-808-0067	http://tsubaki.ph/
Thailand	Tsubakimoto (Thailand) Co., Ltd.	+66 2-262-0667/8/9	http://tsubaki.co.th/
Vietnam	Tsubakimoto Vietnam Co., Ltd.	+84 24-6274-1449	http://tsubaki.net.vn/

EAST ASIA

Korea	Tsubakimoto Korea Co., Ltd.	+82 2-2183-0311	http://tsubakimoto-tck.co.kr/
Taiwan	Taiwan Tsubakimoto Co.	+886 3-3293827	http://tsubakimoto.com.tw/

CHINA

China	Tsubakimoto Chain (Shanghai) Co., Ltd.	+86 21-53966651/2	http://tsubaki-sh.cn/
-------	--	-------------------	---