

---

Modell der BR 38 / P8

**88999**

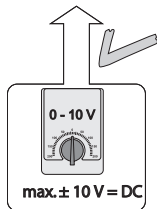

max.  $\pm 10\text{ V} = \text{DC}$

67011

67020 + 67030

67201

67271

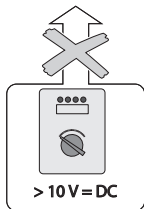

$> 10\text{ V} = \text{DC}$

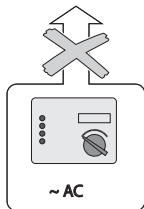

$\sim \text{AC}$

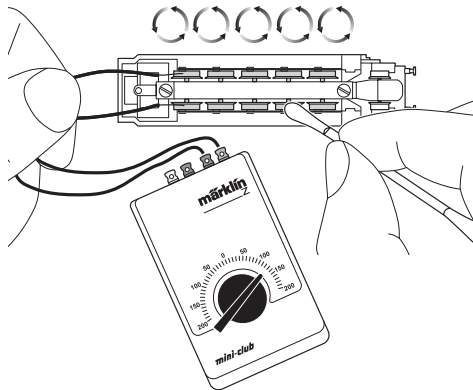

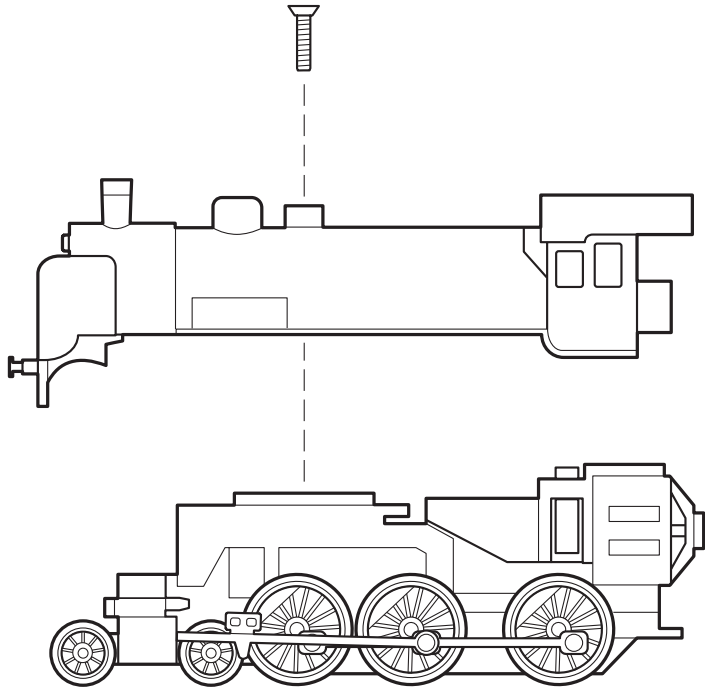

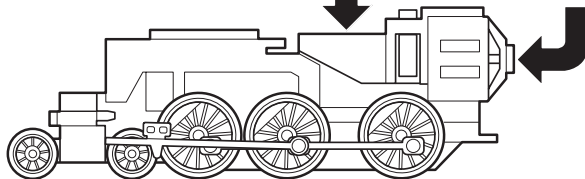
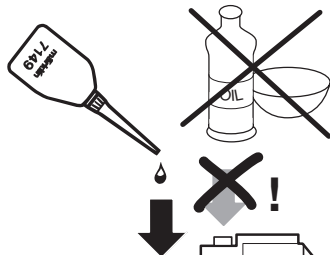

- Nur sparsam ölen (max. 1 Tropfen). Zuviel Öl führt häufig zum Verschmieren der Kollektoren und damit zur Beschädigung des Ankers.
- Oil sparingly (max. 1 drop). Too much oil frequently causes the commutator to become dirty and thereby leads to damage to the armature.
- Lubrifiez en très petite quantité (1 goutte max.). Trop d'huile entraîne souvent l'encrassement du collecteur et à des dommages à l'induit.
- Slechts spaarzaam oliën (max. 1 druppel). Te veel olie leidt vaak tot versmeren van de collector en daarmee tot beschadiging van het anker.

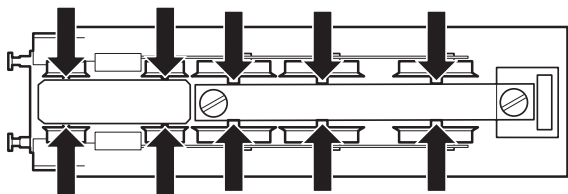

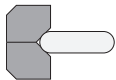

8953

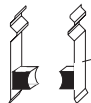
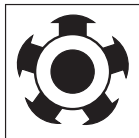
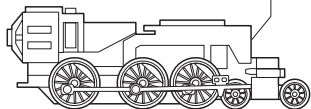
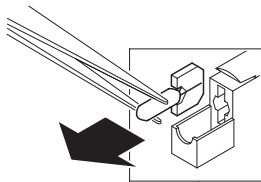

89891

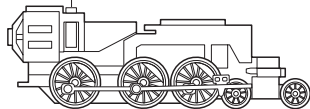
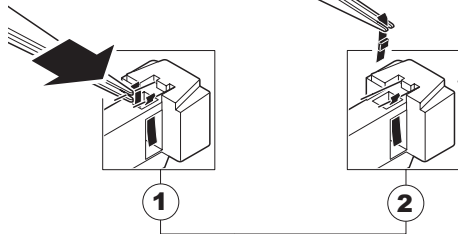

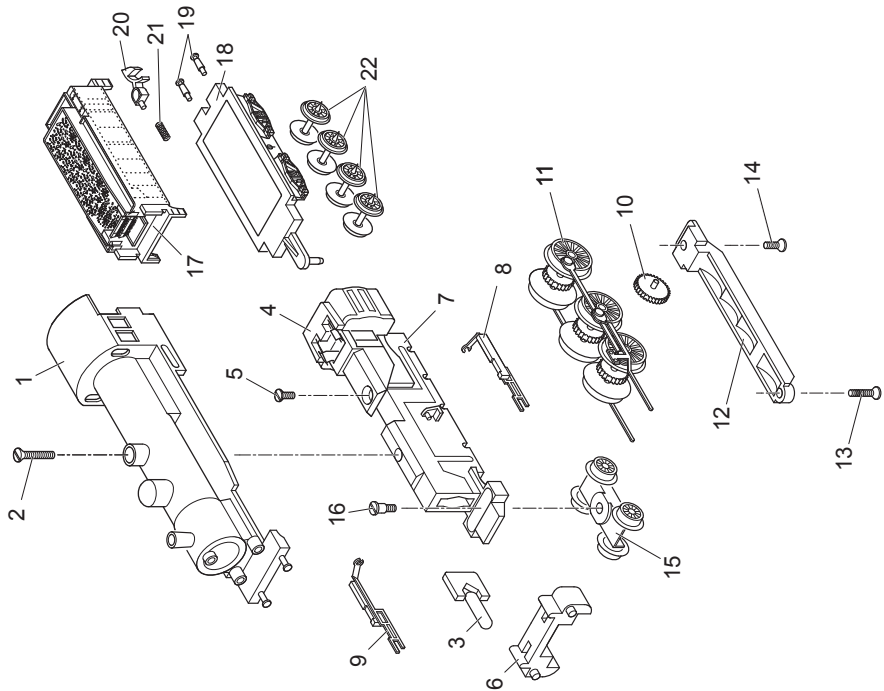

|    |                            |         |
|----|----------------------------|---------|
| 1  | Aufbau komplett            | 152 315 |
| 2  | Senkschraube               | 785 570 |
| 3  | Beleuchtungseinsatz        | 8 953   |
| 4  | Motor                      | 211 912 |
| 5  | Senkschraube               | 785 550 |
| 6  | Zylinderblock              | 266 000 |
| 7  | Traggestell                | 267 660 |
| 8  | Kreuzkopfführung links     | 152 320 |
| 9  | Kreuzkopfführung rechts    | 152 323 |
| 10 | Zwischenradsatz            | 265 930 |
| 11 | Treibradsätze mit Gestänge | 221 808 |
| 12 | Abdeckung                  | 266 010 |
| 13 | Senkschraube               | 785 570 |
| 14 | Senkschraube               | 785 580 |
| 15 | Drehgestell                | 223 557 |
| 16 | Zylinderansatzschraube     | 753 130 |
|    | Tender komplett            | 152 326 |
| 17 | Tendergehäuse              | 152 329 |
| 18 | Tenderboden                | 152 330 |
| 19 | Puffer                     | 761 450 |
| 20 | Kupplungshaken             | 704 200 |
| 21 | Druckfeder                 | 765 680 |
| 22 | Radsatz                    | 223 562 |

**WARNUNG!** Dieses Produkt enthält Magnete. Das Verschlucken von mehr als einem Magneten kann unter Umständen tödlich wirken. Gegebenenfalls ist sofort ein Arzt aufzusuchen.

**WARNING!** This product contains magnets. Swallowing more than one magnet may cause death in certain circumstances. If necessary, see a doctor immediately.

**ATTENTION !** Ce produit contient des aimants. L'ingestion de plusieurs aimants peut être mortelle. Le cas échéant, consulter immédiatement un médecin.

**LET OP!** Dit product bevat magneten. Het inslikken van meer dan één magneet kan onder bepaalde omstandigheden de dood tot gevolg hebben. Waarschuw direct een arts.

Gebr. Märklin & Cie. GmbH  
Postfach 860  
D-73008 Göppingen  
[www.maerklin.com](http://www.maerklin.com)

152332/0609/SmSk  
Änderungen vorbehalten  
© Gebr. Märklin & Cie. GmbH

**[www.ajckids.com](http://www.ajckids.com)**