

---

Modell der BR 61

**88610**

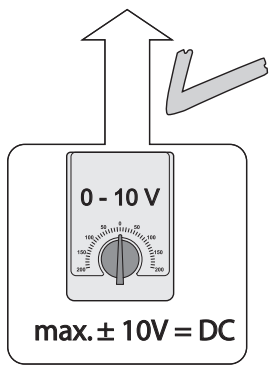

max.  $\pm 10V = DC$

- 67011
- 67020 + 67030
- 67201
- 67271

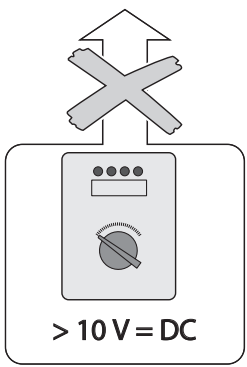

$> 10V = DC$

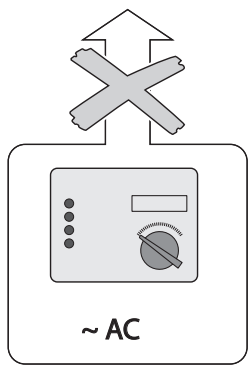

$\sim AC$

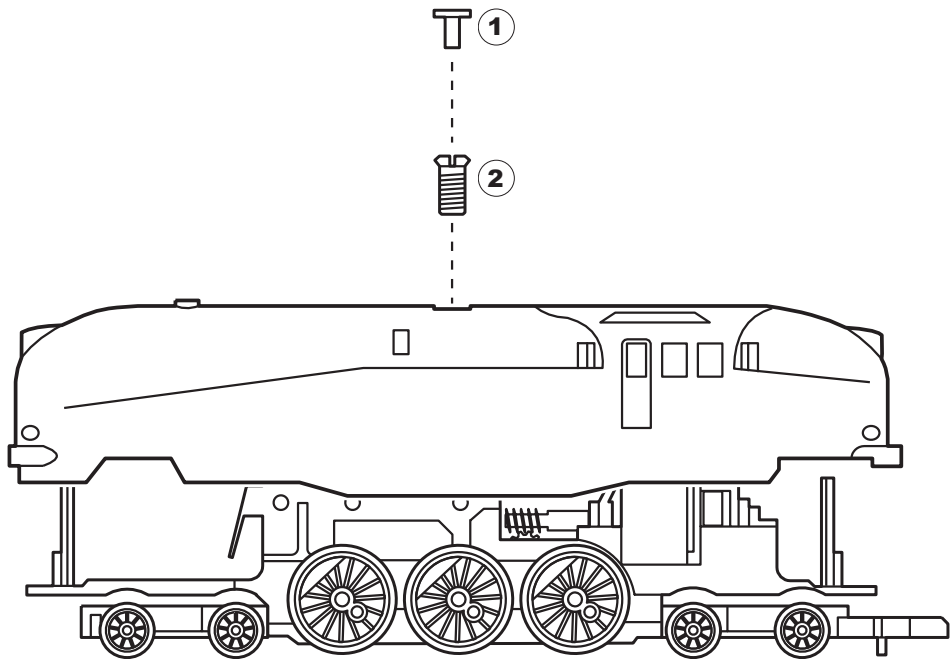

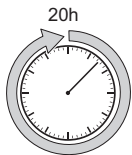

- Nur sparsam ölen (max. 1 Tropfen). Zuviel Öl führt häufig zum Verschmieren der Kollektoren und damit zur Beschädigung des Ankers.

- Oil sparingly (max. 1 drop). Too much oil frequently causes the commutator to become dirty and thereby leads to damage to the armature.

- Lubrifiez en très petite quantité (1 goutte max.). Trop d'huile entraîne souvent l'encrassement du collecteur et à des dommages à l'induit.

- Slechts spaarzaam oliën (max. 1 druppel). Te veel olie leidt vaak tot versmeren van de collector en daarmee tot beschadiging van het anker.

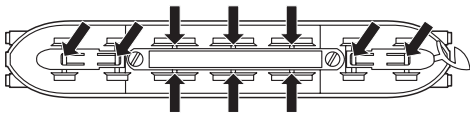
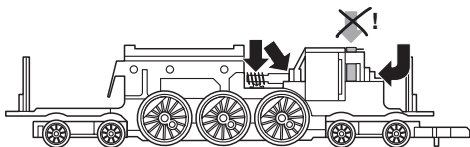

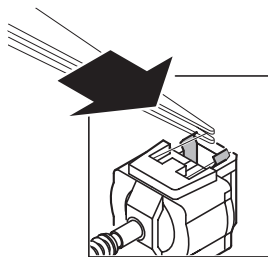
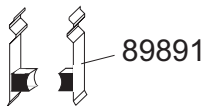

1

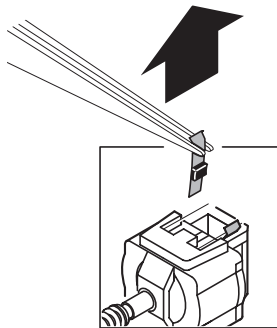

2

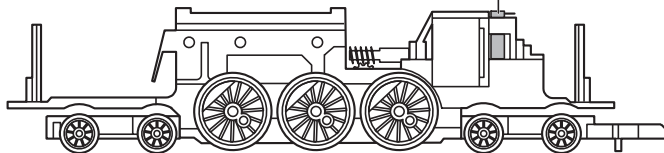

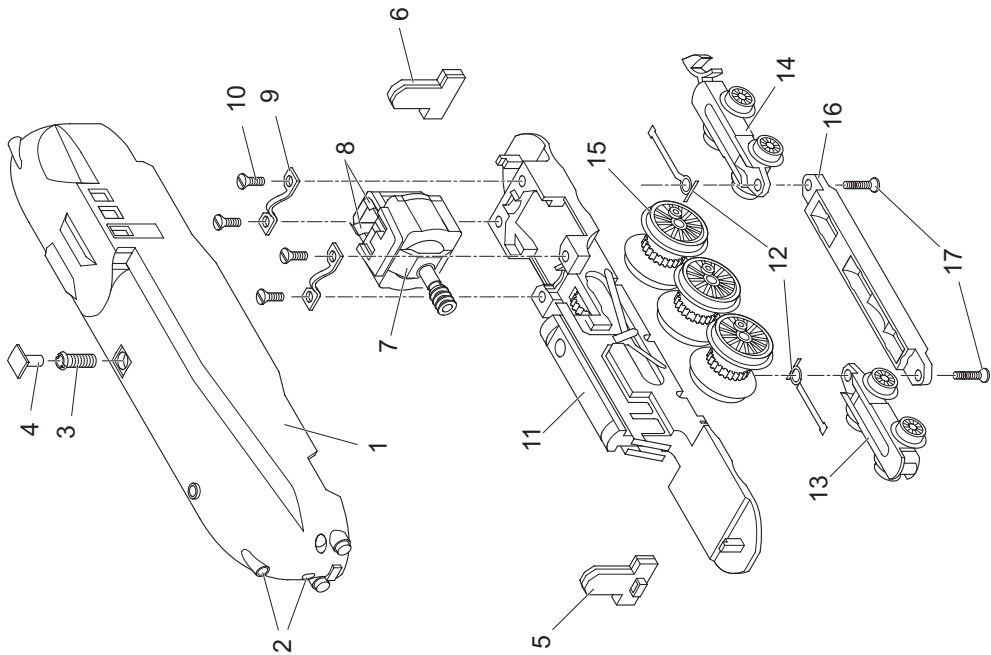

1	Aufbau komplett	150 312
2	Lichtkörper	230 092
3	Schraube	204 707
4	Deckel für Schraube	230 096
5	Beleuchtung vorne	230 107
6	Beleuchtung hinten	230 094
7	Motor	211 918
8	Motorbürsten	89 891
9	Klemmstück	264 880
10	Senkschraube	785 550
11	Traggestell mit Getriebe	230 101
12	Feder	231 005
13	Drehgestell vorne	230 099
14	Drehgestell hinten	230 097
15	Treibradsatz	230 103
16	Abdeckung	230 093
17	Senkschraube	785 580

**WARNUNG!** Dieses Produkt enthält Magnete. Das Verschlucken von mehr als einem Magneten kann unter Umständen tödlich wirken. Gegebenenfalls ist sofort ein Arzt aufzusuchen.

**WARNING!** This product contains magnets. Swallowing more than one magnet may cause death in certain circumstances. If necessary, see a doctor immediately.

**ATTENTION !** Ce produit contient des aimants. L'ingestion de plusieurs aimants peut être mortelle. Le cas échéant, consulter immédiatement un médecin.

**LET OP!** Dit product bevat magneten. Het inslikken van meer dan één magneet kan onder bepaalde omstandigheden de dood tot gevolg hebben. Waarschuw direct een arts.

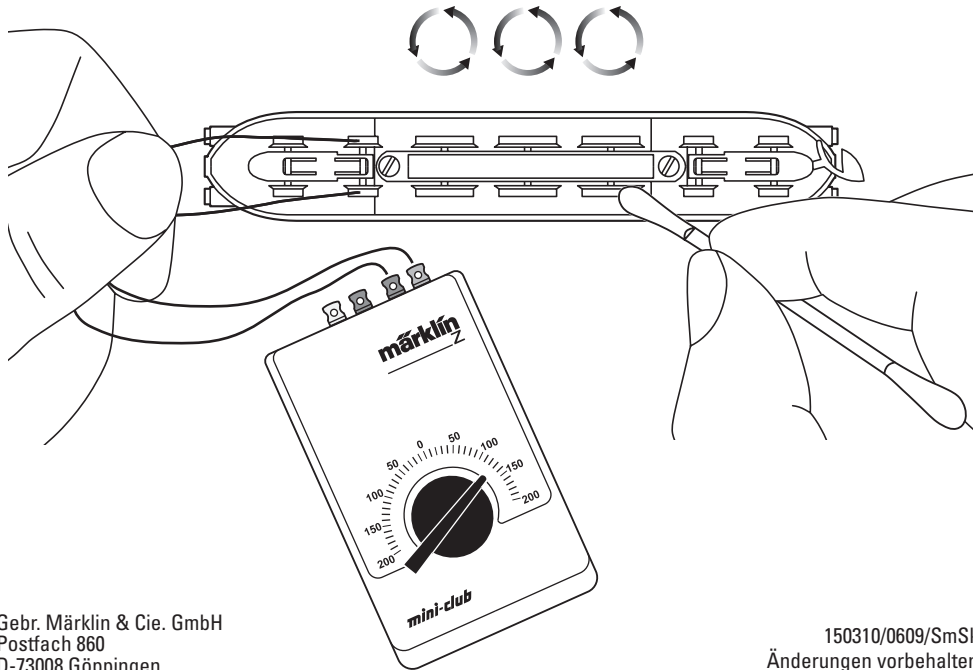

Gebr. Märklin & Cie. GmbH  
Postfach 860  
D-73008 Göppingen  
[www.maerklin.com](http://www.maerklin.com)

150310/0609/SmSk  
Änderungen vorbehalten  
© Gebr. Märklin & Cie. GmbH