

Modell der

BR 61

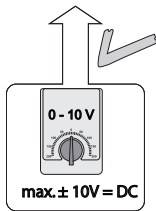
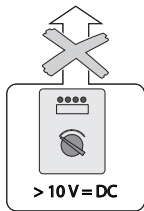

max. $\pm 10V = DC$

67011
67020 + 67030
67201
67271



> 10V = DC

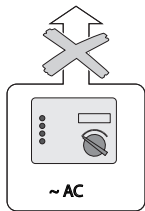

~ AC



1



2

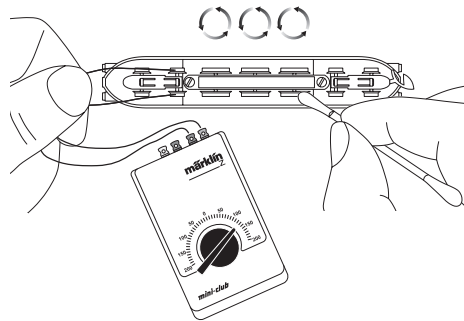
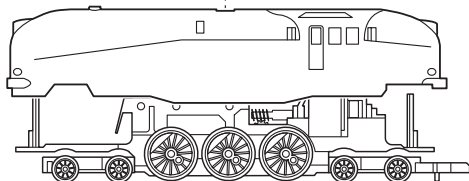

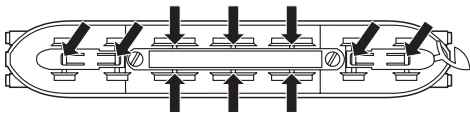
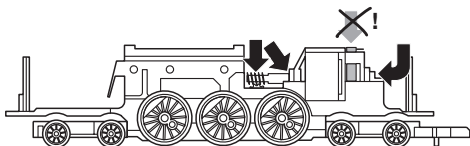
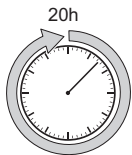

- Nur sparsam ölen (max. 1 Tropfen). Zuviel Öl führt häufig zum Verschmieren der Kollektoren und damit zur Beschädigung des Ankers.
- Oil sparingly (max. 1 drop). Too much oil frequently causes the commutator to become dirty and thereby leads to damage to the armature.
- Lubrifiez en très petite quantité (1 goutte max.). Trop d'huile entraîne souvent l'encrassement du collecteur et à des dommages à l'induit.
- Slechts spaarzaam oliën (max. 1 druppel). Te veel olie leidt vaak tot versmeren van de collector en daarmee tot beschadiging van het anker.

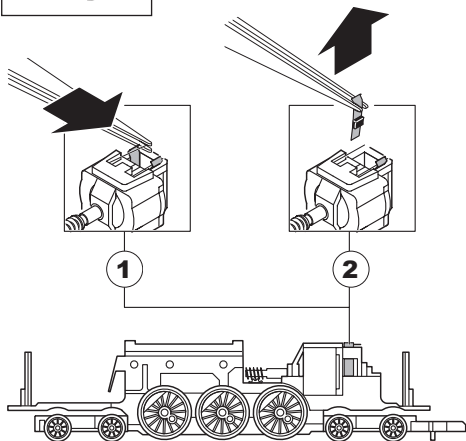
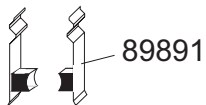
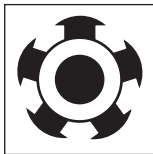

Gebr. Märklin & Cie. GmbH
Postfach 860
D-73008 Göppingen
www.maerklin.com



www.maerklin.com/api

611959/0705/SmEf
Änderungen vorbehalten
© Gebr. Märklin & Cie. GmbH