



Lichtsignale
76371, 76372, 76391, 76393, 76394

Inhaltsverzeichnis	Seite	Indice de contenido	Página
Signalbilder beim Vorbild	3	Posiciones de las señales en la realidad	3
Wichtige Hinweise	6	Notas importantes	12
Programmieren	6	Programación	12
Aufbau	18	Conexión	18
Table of Contents	Page	Indice del contenido	Página
Signal Aspects in the Prototyp	3	Aspetti del segnalamento nel caso del prototipo	3
Important Notes	7	Avvertenze importanti	13
Programming	7	Programmazione	13
Setup	18	Collegamento	18
Sommaire	Page	Innehållsförteckning	Sida
Positions signalétiques réelles	3	Signalbilder hos förebilden	3
Information importante	9	Viktig information	15
Programmation	9	Programmeringen	15
Montage	18	Anslutning	18
Inhoudsopgave	Pagina	Indholdsfortegnelse	Side
Seinbeelden bij het voorbeeld	4	Signalbilleder på forbilledet	3
Belangrijke aanwijzing	10	Vigtige bemærkninger	16
Programmeren	10	Programmeres	16
Opbouwen	18	Tilslutning	18









Signalbilder beim Vorbild
 Signal Aspects in the Prototyp
 Positions signalétiques réelles
 Seinbeelden bij het voorbeeld

Posiciones de las señales en la realidad
 Aspetti del segnalamento nel caso del prototipo
 Signalbilder hos förebilden
 Signalbilleder på forbilledet











<p>Signalbild Gleissperrsignal (76371, 76372): Signal indication of the platform blocking signal (76371, 76372): Aspect du signal de barrage (76371, 76372): Seinbeeld hoofdsein (76371, 76372): Imagen de la señal de bloqueo de la vía (76371, 76372): Aspetto del segnale basso di manovra (76371, 76372): Signalschema spårspärrsignal (76371, 76372): Signalbillede sporspærresignal (76371, 76372):</p>		
<p>Bedeutung: Meaning: Signification: Betekend: Significado: Significato: Innebörd: Betydning:</p>	<p>Rangierfahrt erlaubt Switching Maneuver Allowed Circulation autorisée rangeren toegestaan Aniobras permitidas Manovra consentita rangerfart tillåtet Rangering tilladt</p>	<p>Halt Stop Arrêt Stop Paro Arresto Stopp Stop</p>

Signalbilder beim Vorbild
 Signal Aspects in the Prototyp
 Positions signalétiques réelles
 Seinbeelden bij het voorbeeld

Posiciones de las señales en la realidad
 Aspetti del segnalamento nel caso del prototipo
 Signalbilder hos förebilden
 Signalbilleder på forbilledet

Signalbild Hauptsignal: Signal aspect for a home signal: Position de signal principal : Seinbeeld hoofdsein: Posición señal principal: Aspetti di segnalamento di un segnale principale: Signalbild huvudsignal: Signalbilleder for hovedsignal:	 76391  76393  76394	 76391  76393  76394	 76393  76394	 76394
Bedeutung: Meaning: Signification : Betekend: Significado: Significato: Innebörd: Betydning:	Fahrt Go Voie libre Rijden Marcha Via libera Körning Kø	Halt Stop Arrêt Stop Paro Arresto Stopp Stop	Langsamfahrt Proceed Slowly Ralentissement Langzaam rijden Marcha lenta Rallentamento Krypfart Langsom kørsel	Halt - Rangierfahrt erlaubt Stop - Switching Maneuver Allowed Arrêt, sauf manoeuvres Stop, rangeren toegestaan Paro-maniobras permitidas Arresto-movimento di manovra consentito Stopp-rangerfart tillåtet Stop - Rangering tilladt

Fahrstrom:
 Track Current:
 Courant traction :
 Rijstroom:
 Corriente de tracción:
 Corrente di trazione:
 Körström:
 Kørestrøm:

76371 76372				
76391				
76393				
76394				
	ein on branché aan encendida inserita till til	aus off débranché uit apagada esclusa från fra	ein on branché aan encendida inserita till til	ein on branché aan encendida inserita till til



Wichtige Hinweise

- **ACHTUNG!** Funktionsbedingte scharfe Kanten und Spitzen.
- <http://www.maerklin.com/en/imprint.html>

Die H0-Lichtsignale aus dieser Elektronik-Serie bieten folgende Eigenschaften:

- Alle Hauptsignale bestehen aus einem Signal-Steuermodul und dem zugehörigen Signalmast
- Die Signale können konventionell (Trafo 66470, Stellpult 72720) oder Digital (z. B. mit Keyboard 6040, Central Station oder Mobile station 60653) geschaltet werden. Beim Schalten über Digital ist kein weiterer Decoder notwendig.
- Vorbildgerecht geschieht das Umstellen der Signalbilder durch weiches Überblenden.
- Bei Stellung „Langsamfahrt“ ist der Bediener für eine Anpassung der Geschwindigkeit zuständig.
- Das Signal-Steuermodul kann nur zum Ansteuern der Signale aus der zugehörigen Märklin-Serie verwendet werden.

Programmieren der Profi-Lichtsignale

! Während der Programmierung darf kein Fahrbetrieb stattfinden. Beachten Sie, dass der Programmiervorgang abgebrochen wird, wenn für die Dauer von 30 Sekunden keine Eingaben erfolgen.

Richten Sie die zu programmierenden **Profi-Lichtsignale** auf Ihrem Keyboard ein.

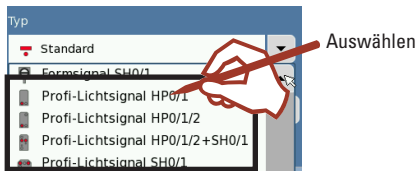

Geben Sie die Schaltzeit für das Programmieren auf 1000 ms ein. Tippen Sie nun auf dieses Symbol  und bestätigen Sie die nachfolgenden Meldungen.

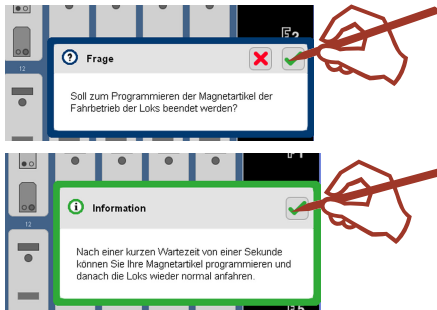

Drücken Sie die Taste „Stop“, um die Stromversorgung zu unterbrechen und schließen Sie das Signal an den Hauptgleis- oder Programmiergleisanschluß an (Seite 18). Achten Sie bitte darauf, dass der mit Karton umhüllte Drahtbügel (Programmierbügel) auf der Unterseite des Decoders eingehakt ist.

Durch erneutes Drücken der Taste „Stop“ die Stromversorgung wieder einschalten.

Im aktiven Programmiermodus blinken nun Signalbilder im Wechsel. Drücken Sie nun das Signalbild des eingerichteten Lichtsignals auf dem Keyboard der Central Station.

76391: Hp1



76371: Sh1
76372: Sh1

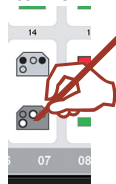

Bei einem mehrbegriffigen Signal blinken anschließend weitere Signalbilder im Wechsel. Die einzelnen Schritte entnehmen Sie den nachfolgenden Beispielen.

76394:
HP1 => Sh1

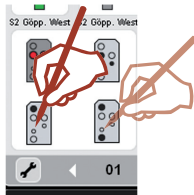

76393:
HP1 => HP2

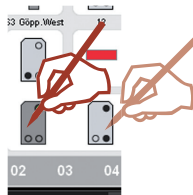

Important Notes

- **WARNING!** Sharp edges and points required for operation.
- <http://www.maerklin.com/en/imprint.html>

The H0 color light signals from this electronic series offer the following features:

- All home signals consist of a signal control module the signal mast that goes with it.
- These signals can be operated conventionally (6646/66470 transformer, 72720 control box) or digitally (example: with 6040 Keyboard, Central Station, Mobile Station 60653). No additional decoder is required when operating the signals digitally.
- The change in the signal aspects happens prototypically with a gentle changeover.
- When the signal is set at "slow", the operator is responsible for adjusting the speed of the train.
- The signal control module can only be used to control signals from the Märklin series that belong to it.

Programming the scale color light signals

! No locomotives may be run during the programming procedure. Please note that the programming procedure will be stopped if there are no entries made within 30 seconds. Set up on your Keyboard beforehand the the scale color light Signal to be programmed. Enter the switching time at 1,000 millise-conds for the programming procedure. Now click on this symbol  and confirm the messages that come afterward.

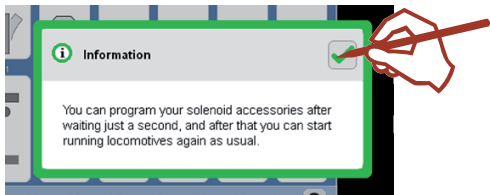
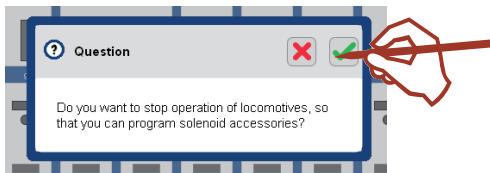
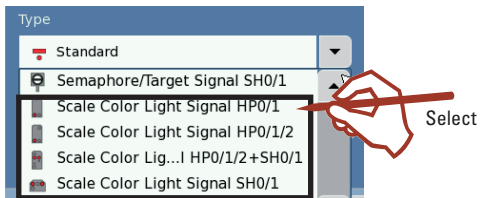

Press the "Stop" button in order to interrupt the current and connect the signal to the main track or to the programming track (page 18). Make sure that the wire bracket (program-

ming bracket) surrounded with cardstock is clipped onto the underside of the decoder. Turn the current back on by pressing the "Stop" button again.

Changing signal aspects will now blink in the active programming mode. Now press the signal image for the color light signal set up on the Keyboard on the Central Station.

76391: Hp1



76371: Sh1

76372: Sh1

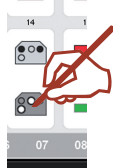

With a signal with more than 2 aspects other signal aspects will alternately blink. The individual steps for these signals can be found in examples further down on this page.

76394:
HP1 => Sh1

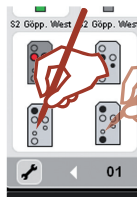

76393:
HP1 => HP2

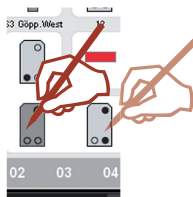

Information importante

- **ATTENTION!** Pointes et bords coupants lors du fonctionnement du produit.
- <http://www.maerklin.com/en/imprint.html>

Les signaux lumineux principaux H0 de cette série électronique ont les caractéristiques suivantes :

- Tous les signaux principaux se composent d'un module de commande et du mât de signalisation correspondant.
- Les signaux peuvent être commutés en mode conventionnel (transfo 66470, pupitre de commande 72720) ou en mode Digital (p. e. avec Keyboard 6040, Central Station, Mobile Station 60653). En cas de commande digitale, aucun décodeur complémentaire n'est nécessaire.
- Le changement de position du signal se fait en douceur de façon réaliste (fondu enchaîné).
- En cas de position «ralentissement», l'opérateur est tenu d'adapter la vitesse.
- Le module de commande ne peut être utilisé que pour la commande des signaux de la série Märklin correspondante.

Programmation le Signal lum. Profi

! Toute exploitation est impossible durant la programmation. Tenez compte du fait que le processus de programmation est interrompu si aucune entrée n'a été faite au bout de 30 secondes.

Installez les signaux à programmer sur votre Keyboard. Définissez un temps de réponse de 1000 ms pour la programmation. Cliquez ensuite sur ce symbole  et confirmez les messages suivants.

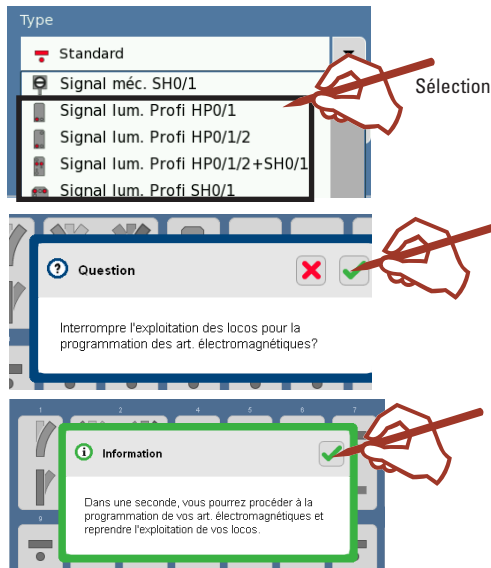

Appuyez sur la touche «Stop» afin d'interrompre l'alimentation en courant et raccordez le signal à la connexion de la voie principale ou de la voie de programmation (page 18). Veillez à ce que l'étrier métallique (étrier de programmation), protégé par du carton et situé sous le décodeur, soit

bien enclenché. Rétablissez l'alimentation en courant en réappuyant sur la touche «Stop».

Lorsque le mode programmation est actif, les indications des signaux clignotent alternativement. Appuyez sur l'indication du signal lumineux installé sur le Keyboard de la Central Station.

76391: Hp1

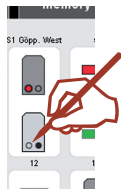

76371: Sh1
76372: Sh1

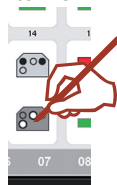

Dans le cas d'un signal à indications multiples, d'autres indications clignotent alors alternativement. Vous trouverez les différentes étapes à suivre dans les exemples suivants.

76394:
HP1 => Sh1

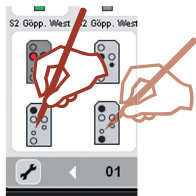

76393:
HP1 => HP2

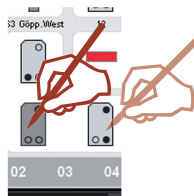

Belangrijke aanwijzing

- **OPGEPAST!** Functionele scherpe kanten en punten.
- <http://www.maerklin.com/en/imprint.html>

De H0-lichtseinen uit deze elektronische serie hebben de volgende eigenschappen:

- alle hoofdseinen bestaan uit een sein-besturingsmodule en een daarbij behorende seinmast.
- de seinen kunnen conventioneel (trafo 66470, schakelkast 72720) of digitaal (bijv. met een keyboard 6040, Central Station, Mobile Station 60653) geschakeld worden. Bij het digitale schakelen is geen extra decoder nodig.
- bij het omschakelen van het seinbeeld wordt, overeenkomstig het voorbeeld, het vorige beeld langzaam door het nieuwe beeld overstuurd.
- bij het seinbeeld "langzaam rijden" moet de bediener zelf de snelheid van de trein aanpassen.
- de sein-besturingsmodule kan alleen gebruikt worden voor het aansturen van de seinen uit de bijbehorende Märklin-serie.

Programmeren de profi-lichtsein

! Tijdens het programmeren mag er geen rijbedrijf plaats vinden. Let er op dat de programmering afgebroken wordt als er gedurende 30 sec. geen invoer heeft plaatsgevonden. Voer het te programmeren sein in op het keyboard. Geef een schakeltijd van 1000 ms in.

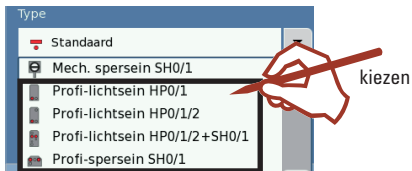

Druk nu op dit symbool  en bevestig de daarop volgende meldingen.

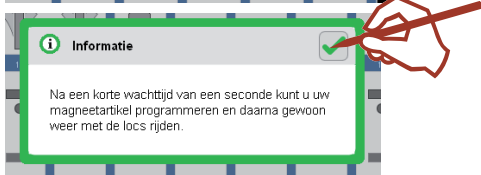

Druk op de “Stoptoets” om de stroomvoorziening te onderbreken en sluit het sein aan op het hoofdof pro-grammeerspoor (pagina 18). Let er op dat de met karton omhulde draadbeugel (programmeerbeugel) om de onder-zijde van de decoderprint is geklemd. Door opnieuw op de

“Stoptoets” te drukken, de stroomvoorziening weer inschakelen.

In de geactiveerde programmeermodus knipt nu een afwisselend seinbeeld. Druk nu op het seinbeeld van het ingevoerde profi-lichtsein op het keyboard van het Central Station.

76391: Hp1



76371: Sh1



Bij een meerstanden sein knipt nu afwisselend de volgende seinbeelden. De handelingen vindt u stap voor stap in de onderstaande voorbeelden.

76394:
HP1 => Sh1

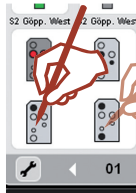

76393:
HP1 => HP2

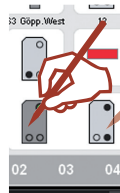

Notas importantes

- ¡**ATENCIÓN!** Esquinas y puntas afiladas condicionadas a la función.
- <http://www.maerklin.com/en/imprint.html>

Las señales luminosas de la serie electrónica tienen las siguientes características:

- Todas las señales principales se componen de un módulo de gobierno y un poste de luces.
- Las señales se pueden gobernar de forma convencional (transformador 66470, pupitre 72720) o también Digital (p.e. con el Keyboard 6040, Central Station, Mobile Station 60653). Para un gobierno Digital no hace falta ningún decoder.
- Transición suave del cambio de luces, al igual que la realidad.
- El usuario debe adaptar la velocidad de su locomotora si la señal marca "marcha lenta prevista".
- El módulo de gobierno de señales solamente sirve para las señales de la serie de Märklin.

Programación de las señales luminosas profesionales

! No está permitida la circulación de trenes durante la programación. Tenga presente que la operación de programación se cancela si no se introduce ningún dato durante 30 segundos.

Configure en el teclado las señales que desee programar. Introduzca como tiempo de conmutación para la programación el valor de 1000 ms.

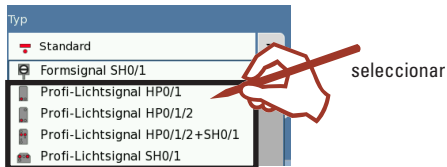

Toque ahora con la mano este símbolo  y confirme los siguientes mensajes.

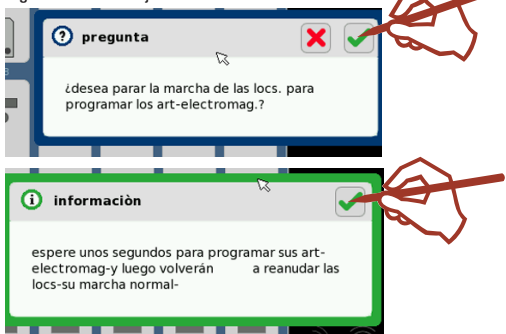

Pulse la tecla "Stop" para interrumpir la alimentación eléctrica y conecte la señal a la conexión de la vía principal o de la vía de programación (página 18). Asegúrese de que el estribo de alambre envuelto con cartón (estribo de programación) esté enganchado en el lado inferior del decoder. Pulsando de nuevo la tecla "Stop", encender de nuevo la alimentación eléctrica.

En el modo de programación activo destellan ahora de modo alterno los aspectos de la señal. Pulse a continuación el aspecto de la señal luminosa instalada en el teclado de la Central Station.

76391: Hp1



76371: Sh1
76372: Sh1

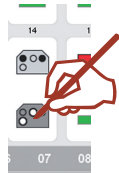

En el caso de una señal de varios aspectos, acto seguido destellan de modo alterno aspectos adicionales de la señal. Encontrará los distintos pasos en los ejemplos a continuación expuestos.

76394:
HP1 => Sh1

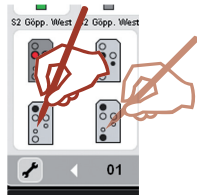

76393:
HP1 => HP2

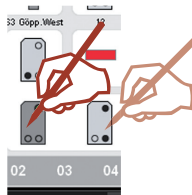

Avvertenze importanti

- **AVVERTENZA!** Per motivi funzionali i bordi e le punte sono spigolosi.
- <http://www.maerklin.com/en/imprint.html>

I segnali luminosi in H0 provenienti da questa serie elettronica presentano le seguenti caratteristiche:

- Tutti i segnali principali sono costituiti da un modulo di comando del segnale e dal corrispettivo paletto del segnale.
- Tali segnali possono venire commutati in modo tradizionale (trasformatore 66470, quadro di comando 72720) oppure in modo Digital (ad es. con Keyboard 6040, Central Station, Mobile Station 60653). Nel caso della commutazione tramite Digital non è necessario alcun ulteriore Decoder.
- La modificazione degli aspetti di segnalamento avviene in modo fedele al prototipo attraverso una leggera dissolvenza.
- In caso di disposizione su "marcia con rallentamento", è responsabile il manovratore per un adeguamento della velocità.
- Il modulo di comando del segnale può venire utilizzato soltanto per il controllo dei segnali appartenenti alla corrispettiva serie Märklin.

Programmazione dei segnali luminosi professionali

! Durante la programmazione non deve avere luogo alcun esercizio di marcia. Prestate attenzione al fatto che la procedura di programmazione viene interrotta, quando non si verifica alcun inserimento dati per la durata di 30 secondi. Installate i segnali da programmare sulla Vostra Keyboard. Introducete la durata di commutazione per la programmazione su 1000 ms.

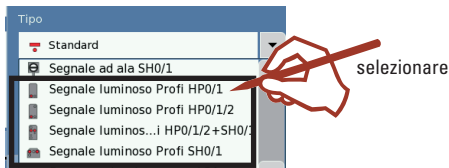

Adesso premete col dito su questo simbolo  e date conferma ai successivi messaggi.

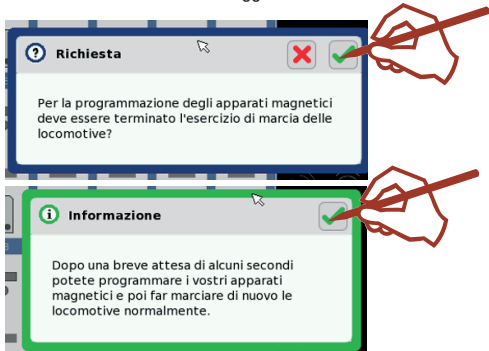

Premete il tasto "Stop", per interrompere l'alimentazione di corrente, e collegate il segnale alla connessione per il binario principale o per il binario di programmazione (pagina 18). A questo scopo si prega di fare attenzione al fatto che il ponticello di filo confezionato nella scatola (ponticello di

programmazione) sia inserito nei morsetti sul lato inferiore del Decoder. Mediante una nuova pressione del tasto "Stop" attivate nuovamente l'alimentazione di corrente. Nella modalità di programmazione attivata, adesso gli aspetti del segnale lampeggiano ciclicamente. Ora premete l'aspetto di segnalamento del segnale luminoso equipaggiato sulla Keyboard della Central Station.

76391: Hp1

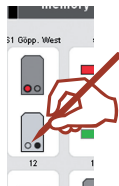

76371: Sh1

76372: Sh1

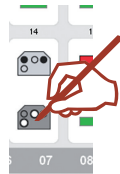

Nel caso di un segnale a numerosi aspetti, successivamente lampeggiano ciclicamente ulteriori aspetti del segnale. Vogliate ricavare i singoli passi dai seguenti esempi.

76394:
HP1 => Sh1

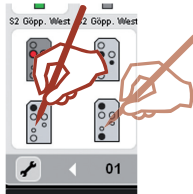

76393:
HP1 => HP2

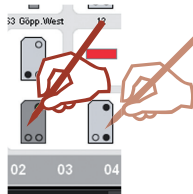

Viktig information

- **WARNING!** Funktionsbetingade vassa kanter och spetsar.
- <http://www.maerklin.com/en/imprint.html>

HO ljussignaler från denna elektronikserie erbjuder följande egenskaper:

- Alla huvudsignaler består av en signalstyrmodul och tillhörande signalstolpe.
- Signalerna kan ställas konventionellt (Trafo 66470, Ställpult 72720) eller digitalt (med Keyboard 6040, Central Station, Mobile Station 60653). Vid koppling via Digital behövs ingen ytterligare dekoder.
- Omställning av signalbilderna sker förebildstroget genom mjuk övergång.
- Vid inställning "krypfart" är användaren skyldig att anpassa hastigheten själv.
- Signalstyrmodulen kan endast användas för att styra signalerna från tillhörande Märklinserie.

Programmering av profi ljussignaler

! Under programmeringen får ingen trafik äga rum. Observera att inprogrammeringen avbryts om det inte sker någon inskrivning inom 30 sekunder.

Ställ in signalen som ska programmeras på Ert Keyboard. Ange tidsrymden 1000 ms för programmeringen.

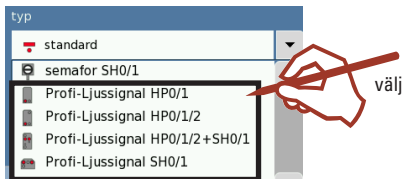

Peka därefter på symbolen  och bekräfta sedan uppgifterna på skärmen.

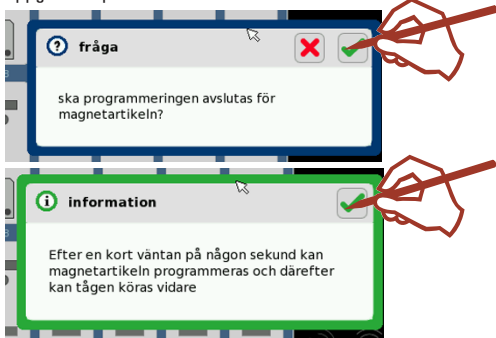

Tryck på "Stop"-knappen för att bryta strömmen och anslut därefter signalen till huvudspårets anslutning eller till programmeringspårets anslutning (sida 18). Se därvid till att den med kartong omslagna trådbygeln (programmeringsbygeln) är fasthakad på dekoderns undersida. Tryck nu åter på

“Stop”-knappen för att koppla på strömmen igen.

När signalen befinner sej i aktivt programmeringsmodus blinkar signalens ljusbilder omväxlande. Tryck nu på signal-bilden för den inkopplade ljussignalen på Central Stations Keyboard.

76391: Hp1



76371: Sh1

76372: Sh1

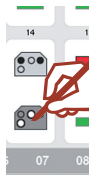

Är det en signal med flera olika ljusbilder blinkar alla ljusbilderna omväxlande. Hur inställningen av signalen går till visas steg för steg i följande exempel.

76394:

HP1 => Sh1

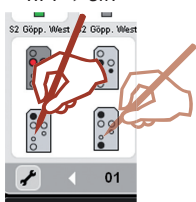

76393:

HP1 => HP2

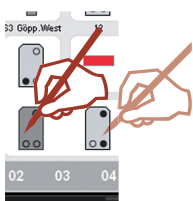

Viktige bemærkninger

- **ADVARSEL!** Skarpe kanter og spidser pga. funktionen.
- <http://www.maerklin.com/en/imprint.html>

De nye H0-lyssignaler i denne elektronikserie har følgende egenskaber:

- Alle hovedsignaler består af et signal-styremodul og den tilhørende signalmast.
- Signalerne kan tilsluttes konventionelt (Trafo 66470, Styrepult 72720) eller digitalt (med Keyboard 6040, Central Station, Mobile Station 60653). Ved digital tilslutning er der ikke brug for ydeligere dekoder.
- Ligesom på forbilledet sker omstillingen af signalbillederne ved hjælp af blød ind- og udblænding.
- Ved stillingen “Langsom kørsel” skal brugeren sørge for tilpasning af hastigheden.
- Signal-styremodulet kan kun anvendes til styring af signaler i den tilhørende Märklinserie.

Programmering de professionelle lyssignaler

! Der må ikke foregå nogen kørsel, når der programmeres. Vær opmærksom på, at programmeringsproceduren afbrydes, hvis der indenfor et tidsrum på 30 sekunder ikke indgives information.

Opret de signaler, der skal programmeres, på dit keyboard. Sæt omskiftningstiden til programmering til 1000 ms.

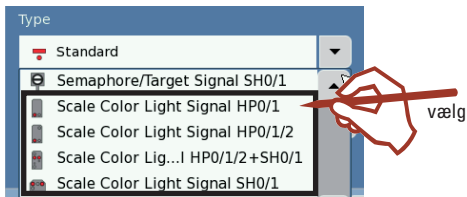

Tryk nu på dette symbol  og bekræft de efterfølgende meldinger.

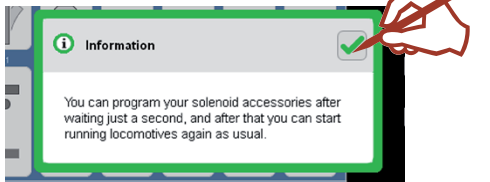
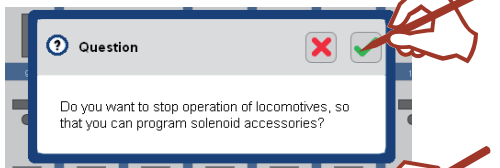

Tryk på tasten „Stop“ for at afbryde strømforsyningen, og tilslut signalet til hovedspors- eller programmeringsspor-

stilslutningen (side 18). Vær venligst opmærksom på, at den med pap beklædte wirebøjle (programmeringsbøjle) på undersiden af dekoderen er hængt ind. Tænd igen for strømforsyningen ved et fornyet tryk på tasten „Stop“.

I aktiv programmeringsmodus blinker signalbilleder skiftevis. Tryk nu på signalet for det oprettede lyssignal på Central Stations keyboard.

76391: Hp1

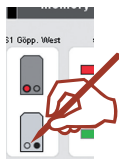

76371: Sh1
76372: Sh1



Ved et multibegrebssignal blinker derefter yderligere signalbilleder skiftevis. De enkelte skridt ses ud fra de efterfølgende eksempler.

76394:
HP1 => Sh1

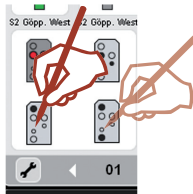

76393:
HP1 => HP2

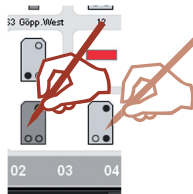

Aufbau • Setup • Montage • Opbouwen • Conexión • Collegamento • Anslutning • Tílslutning

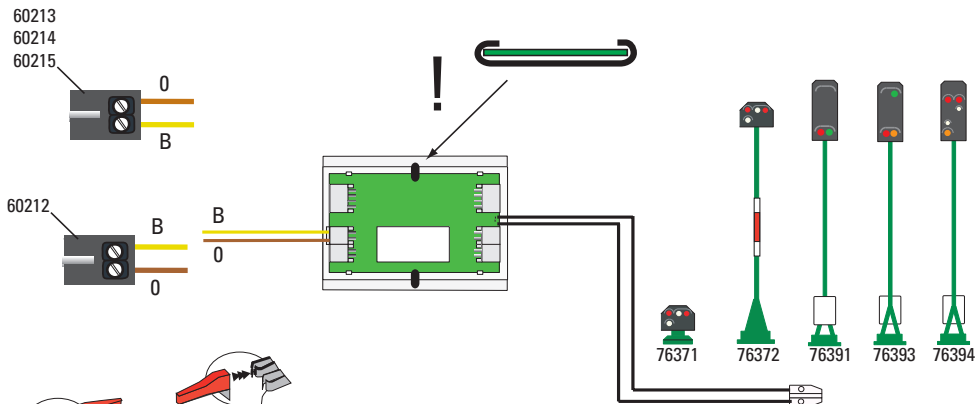

Signalabschnitt herstellen

Making a signal block

Construire section d'arrêt

Stopsectie maken (alleen bij 74371 of 74391)

Crear un tramo aislado delante de la señal Allestimento della tratta di segnalamento

Signalavsnitt behövs endast för 74371 eller 74391

Udførelse af signalafsnit

Konventioneller Anschluss 76371, 76372, 76391
 Conventional Wiring Connections 76371, 76372, 76391
 Connexion conventionnelle 76371, 76372, 76391
 Conventionele aansluiting 76371, 76372, 76391

Conexión convencional 76371, 76372, 76391
 Collegamento tradizionale 76371, 76372, 76391
 Konventionell anslutning 76371, 76372, 76391
 Konventionel tilslutning 76371, 76372, 76391

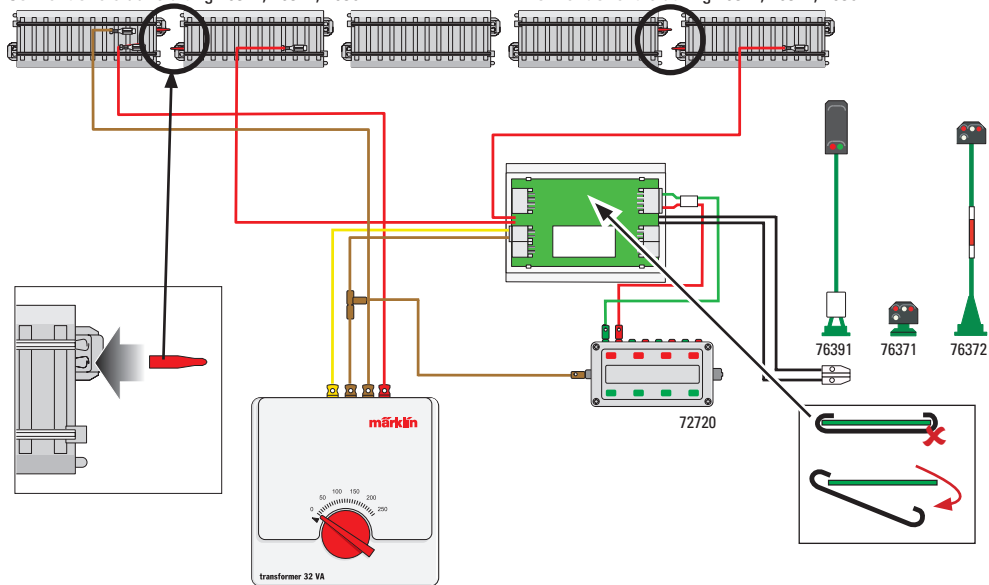

Konventioneller Anschluss 76393, 76394
 Conventional Wiring Connections 76393, 76394
 Connexion conventionnelle 76393, 76394
 Conventionele aansluiting 76393, 76394

Conexión convencional 76393, 76394
 Collegamento tradizionale 76393, 76394
 Konventionell anslutning 76393, 76394
 Konventionel tilslutning 76393, 76394

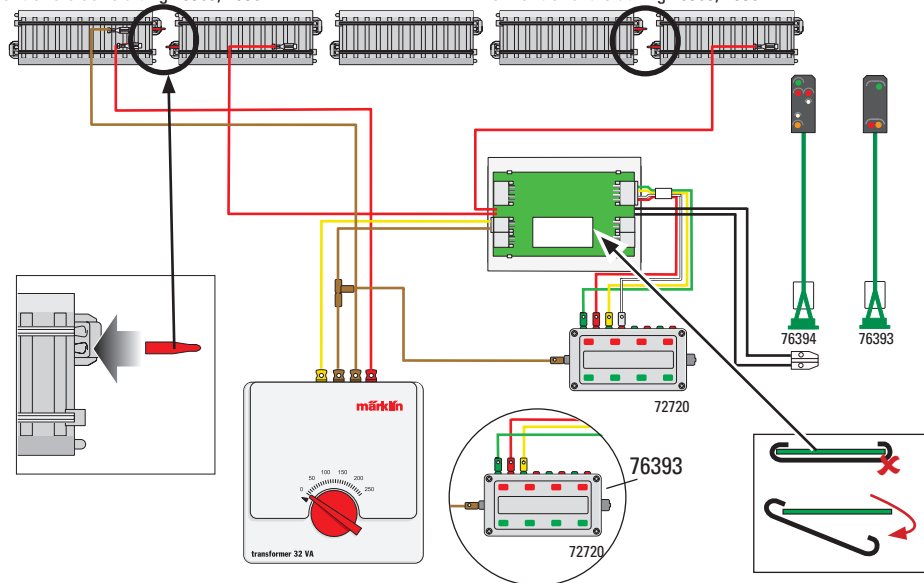

Digital-Anschluss
 Digital Wiring Connections
 Connexion Digital
 Digitale aansluiting

Conexión digital
 Collegamento Digital
 Digitalanslutning
 Digitaltilslutning

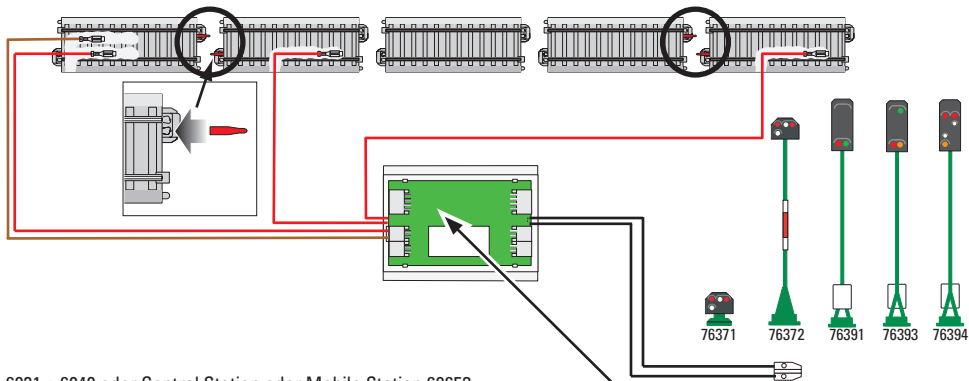

- 6021 + 6040 oder Central Station oder Mobile Station 60653
- 6021 + 6040 or Central Station or Mobile Station 60653
- 6021 + 6040 ou Central Station ou Mobile Station 60653
- 6021 + 6040 of Central Station of Mobile Station 60653
- 6021 + 6040 o Central Station o Mobile Station 60653
- 6021 + 6040 oppure Central Station oppure Mobile Station 60653
- 6021 + 6040 eller Central Station eller Mobile Station 60653
- 6021 + 6040 eller Central Station eller Mobile Station 60653

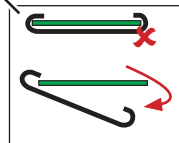

Erweiterung mit separatem Vorsignal
Expansion with a separate advance signal
Extension avec signal avertisseur séparé
Uitbreiden met een apart voorsein
Ampliación con señal avanzada separada
Completamento con un segnale di preavviso
Komplettering med separat försignal
Udvidelse med separat fremskudt signal

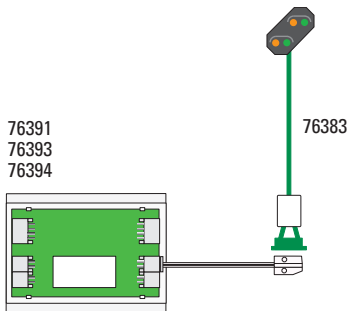

Signal- Steuermodul in das C- Gleis einbauen
Signal control module installed in C track
Installation du module de commande en voie C
Installazione del modulo di comando in de C-rail inbouwen
Montar el módulo en la base de la vía C
Installazione del modulo di comando per segnali sul binario C
Signalstyrmodul monteres in på C-skenan
Indbyg signal-styremodulet i C-sporet

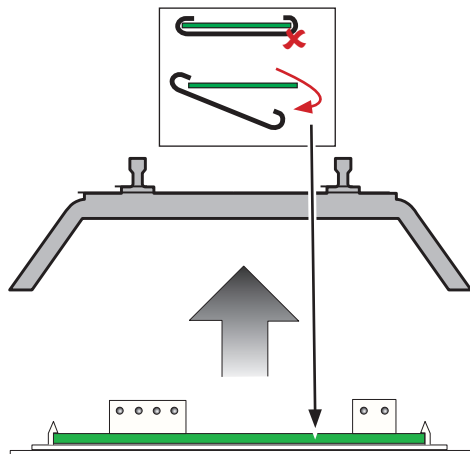

Signal- Steuermodul unter der Anlage montieren
Signal control module installed under the layout
Installation du module de commande sous la table de roulement
Sein-besturingsmodule onder de baan monteren
Montar el módulo debajo del tablero
Montaggio del modulo di comando per segnali sotto il basamento dell'impianto
Signalstyrmodul monteras under anläggningen
Monter signal-styremodulet under anlægget.

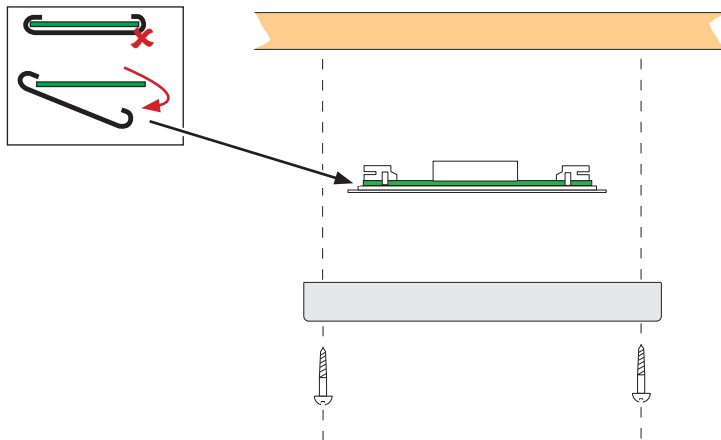

Halter für Signalmast montieren
 Mounting brackets for signal masts
 Installation d'un support pour le mât de signal
 Houder voor de seinmast monteren
 Montar el soporte del poste
 Montaggio del supporto del paletto per segnali
 Hållare för signalstolpe monteras
 Monter holder til signalmast

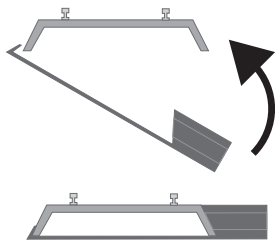

Hinweis: Anschlussplatte lässt sich nur in einer Richtung einsetzen!

Important: The wiring connections board can only be installed in one direction!

Remarque : la plaquette de connexion ne peut être installée que dans un sens !

Opmerking: de aansluitplaat laat zich maar in één richting gebruiken!

Nota: ¡la placa base solamente entra en un sentido!

Avvertenza: la piastra di connessione è possibile installarla soltanto con un determinato orientamento!

OBS: Anslutningsplatta kan endast monteras i en riktning!

Henvisning: Tilslutningspladen kan kun indsættes i én retning!

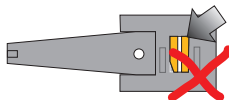
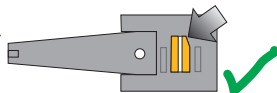
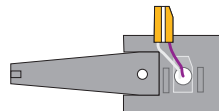
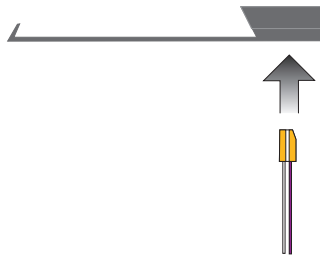

Signalmast aufsetzen. Hinweis: Signalmast lässt sich nur in einer Richtung aufsetzen.
Installing the Signal Mast. Important: The signal mast can only be installed in one direction.
Pose du mât de signal. Remarque : le mât de signal ne peut être installé que dans un sens !
Seinmast plaatsen. Opmerking: seinmast laat zich maar in één richting plaatsen.
Colocar el poste de la señal. Nota: el poste solamente entra en un sentido.
Installazione del paletto del segnale Avvertenza: il paletto del segnale è possibile installarlo soltanto con un determinato orientamento.
Signalstolpe sätts upp. OBS: Signalstolpe kan endast sätts upp i en riktning.
Anbring signalmasten. Henvisning: Signalmasten kan kun sættes på i én retning!

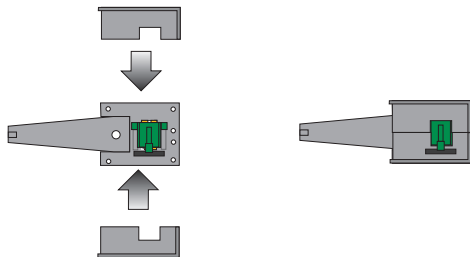
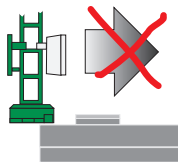
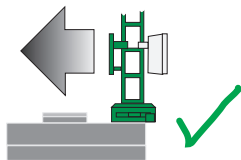

Steigung oder Gefälle beim Signalmast ausgleichen (3 % oder 5 %)
Level out an Ascending or Descending Grade at a Signal Mast (3% or 5%)
Equilibrage de la pente près d'un mât de signal (3 % ou 5 %)
Bij stijging of daling de mast bijstellen (3 % of 5 %)
Corregir la inclinación del poste (3 % resp. 5 %)
Adattamento delle salite o delle discese presso il paletto di un segnale (3 % oppure 5 %)
Stigning eller lutning utjämnas vid signalstolpe (3 % eller 5 %)
Stigninger eller fald ved signalmasten skal udjævnes (3% eller 5%)

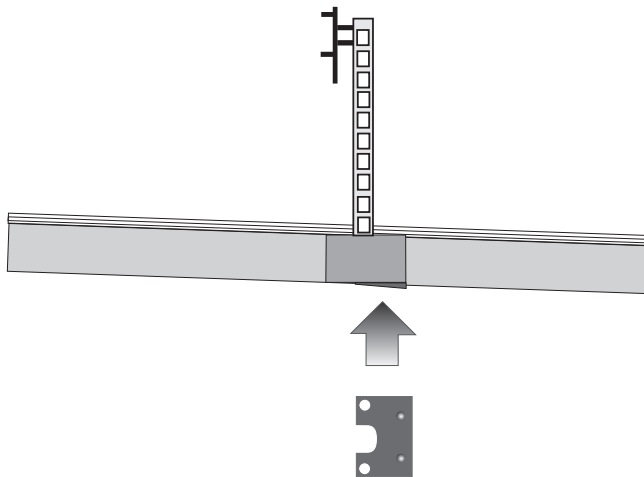

Zusätzlicher Anschlusskontakt für Oberleitung
Additional Feeder Contact for Catenary
Contact supplémentaire pour brancher la caténaire
Extra aansluitcontact voor bovenleiding
Conexión adicional para la catenaria
Contatto di collegamento ausiliario per linea aerea
Extra anslutningskontakt för kontaktledning
Ekstra tilslutningskontakt til overledning

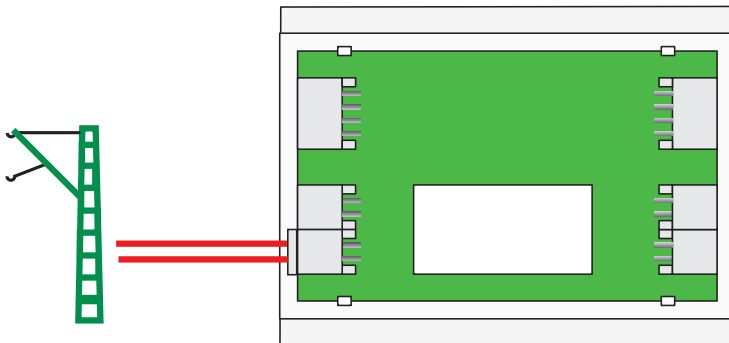

Due to different legal requirements regarding electro-magnetic compatibility, this item may be used in the USA only after separate certification for FCC compliance and an adjustment if necessary. Use in the USA without this certification is not permitted and absolves us of any liability. If you should want such certification to be done, please contact us – also due to the additional costs incurred for this.

Gebr. Märklin & Cie. GmbH
Stuttgarter Strasse 55 - 57
73033 Göppingen
Deutschland
www.maerklin.com



www.maerklin.com/en/imprint.htm

183247/0113/ Ha5Na
Änderungen vorbehalten
© Gebr. Märklin & Cie. GmbH