

C-Gleis • C Track • Voies C • C-Rail • Vias C • traccia C • C spår • C spor
K-Gleis • K Track • Voies K • K-Rail • Vias K • traccia K • K spår • K spor
M-Gleis • M Track • Voies M • M-Rail • Vias M • traccia M • M spår • M spor

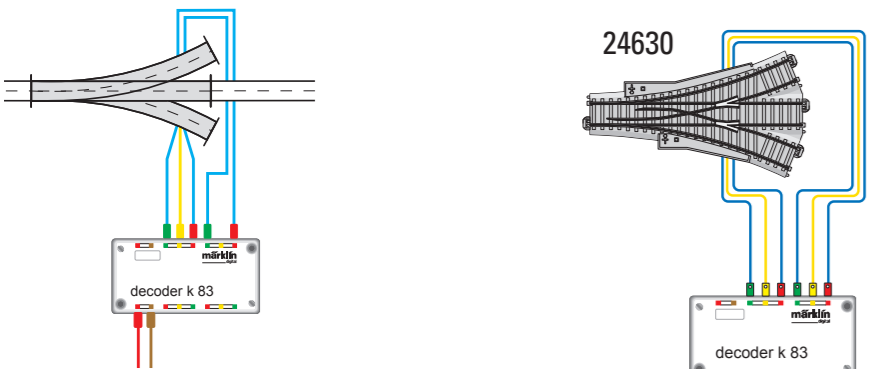

Geeignete Anschluss-Stecker und -Buchsen: 71400
 Suitable plugs and sockets for connections: 71400
 Fiches et douilles de raccordement appropriées: 71400
 Voor het aansluiten geschikte stekkers en stekkerbussen: 71400
 Enchufes y tomas de corriente adecuado: 71400
 Spine e prese adeguate: 71400
 Lämplig stickproppar och uttag: 71400
 Rigtige stik og stikkontakter: 71400

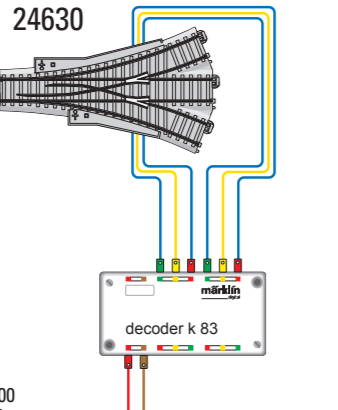

Geeignete Anschluss-Stecker und -Buchsen: 71400
 Suitable plugs and sockets for connections: 71400
 Fiches et douilles de raccordement appropriées: 71400
 Voor het aansluiten geschikte stekkers en stekkerbussen: 71400
 Enchufes y tomas de corriente adecuado: 71400
 Spine e prese adeguate: 71400
 Lämplig stickproppar och uttag: 71400
 Rigtige stik og stikkontakter: 71400

Entkupplungsgleis
 Uncoupling track
 Élément de voie dételeur
 Ontkoppelrail
 Tramo de vía de desenganche
 Binario di sganciamento
 Avkopplingspår
 Afkoblingskinne

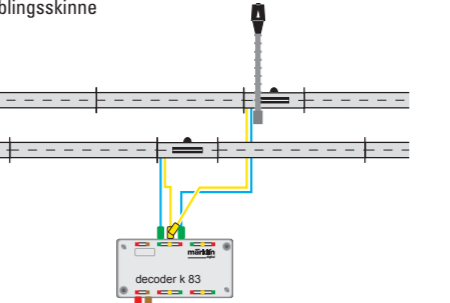

Geeignete Anschluss-Stecker und -Buchsen: 71400
 Suitable plugs and sockets for connections: 71400
 Fiches et douilles de raccordement appropriées: 71400
 Voor het aansluiten geschikte stekkers en stekkerbussen: 71400
 Enchufes y tomas de corriente adecuado: 71400
 Spine e prese adeguate: 71400
 Lämplig stickproppar och uttag: 71400
 Rigtige stik og stikkontakter: 71400

Märklin **my world**:
 Anschluss Weichenantrieb
 Connection Turnout
 Mechanism Connexion Moteur d'aiguillage
 Aansluiting wisselaandrijving
 Conexión de accionamiento de aguja
 Connessione azionamento per deviatore
 Anslutning växeldrivning
 Tilslutning sporskiftedrev

Kabelfarben beachten!
 Cable color note!
 Note de couleur de câble !
 Kabel kleur opmerking!
 Cable nota de color!
 Colore cavo nota!
 Kabel färg notera!
 Ledningsfarve note!

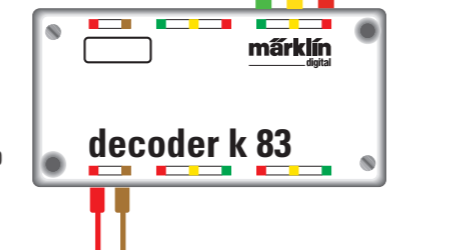

Geeignete Anschluss-Stecker und -Buchsen: 71400
 Suitable plugs and sockets for connections: 71400
 Fiches et douilles de raccordement appropriées: 71400
 Voor het aansluiten geschikte stekkers en stekkerbussen: 71400
 Enchufes y tomas de corriente adecuado: 71400
 Spine e prese adeguate: 71400
 Lämplig stickproppar och uttag: 71400
 Rigtige stik og stikkontakter: 71400

Weichenantrieb Spur 1
 Turnout Mechanism 1
 Moteur d'aiguillage 1
 Wisselaandrijving 1
 Accionamiento de aguja para ancho de vía 1
 Azionamento per deviatore in scartamento 1
 Växeldrivning 1
 Sporskiftedrev 1

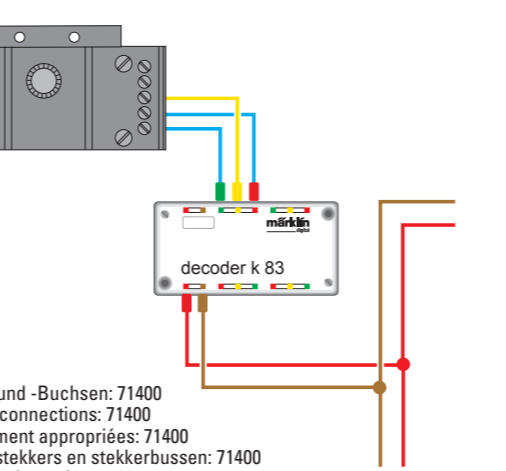

Geeignete Anschluss-Stecker und -Buchsen: 71400
 Suitable plugs and sockets for connections: 71400
 Fiches et douilles de raccordement appropriées: 71400
 Voor het aansluiten geschikte stekkers en stekkerbussen: 71400
 Enchufes y tomas de corriente adecuado: 71400
 Spine e prese adeguate: 71400
 Lämplig stickproppar och uttag: 71400
 Rigtige stik og stikkontakter: 71400

This device complies with Part 15 of the FCC Rules.
 Operation is subject to the following two conditions:
 (1) This device may not cause harmful interference, and
 (2) this device must accept any interference received, including interference that may cause undesired operation.



Gebr. Märklin & Cie. GmbH
 Stuttgarter Str. 55 - 57
 73033 Göppingen
 Deutschland
 www.maerklin.com

www.maerklin.com/en/imprint.html

168452/0711/Ha1Pw
 Änderungen vorbehalten
 © Gebr. Märklin & Cie. GmbH



Decoder k 83
 60830

Decoder-Gehäuse öffnen und befestigen
 Decoder housing removal and installation
 Ouverture et fermeture du boîtier du décodeur
 Decoder-kastje openen en bevestigen
 Vivienda decodificador y adjuntar
 Alloggiamento decoder e collegarlo
 Dekoder öppet och säkert
 Decoder åbent og sikkert

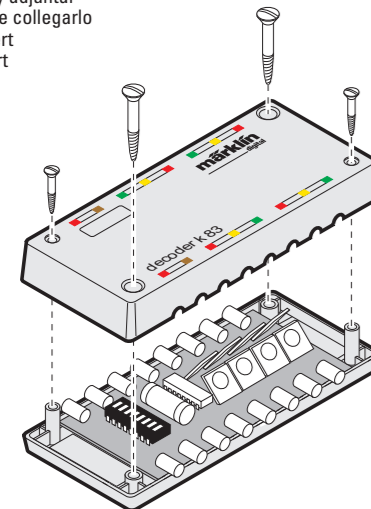

Codieren
 Coder
 Codage
 Coderen
 Codificar
 Codificare
 Koda
 Kode

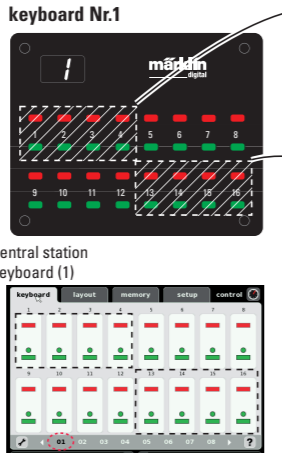

Zuordnen der Decoder-Adresse
 Assigning the decoder address
 Affectation de l'adresse du décodeur
 Decoder-Adres toewijzen

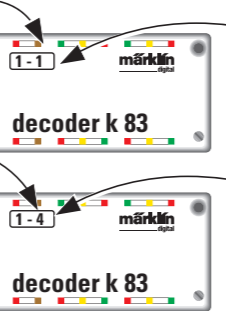

Asignación de la dirección del decodificador
 Assegnare l'indirizzo decoder
 Tildela dekoder address
 Tildeling af dekoder-adresse



Code-Tabelle • Code Table • Tableau des codes • Code-tabel • Tabla de cifrado • Codice tabella • Kodtabellen • Kodetabellen

Gruppe	Nummer	Schalter ON	Gruppe	Nummer	Schalter ON	Gruppe	Nummer	Schalter ON	Gruppe	Nummer	Schalter ON
Group	Number	Switch ON	Group	Number	Switch ON	Group	Number	Switch ON	Group	Number	Switch ON
Groupe	Numéro	Interrupteurs ON	Groupe	Numéro	Interrupteurs ON	Groupe	Numéro	Interrupteurs ON	Groupe	Numéro	Interrupteurs ON
Groep	Nummer	Schakelaar ON	Groep	Nummer	Schakelaar ON	Groep	Nummer	Schakelaar ON	Groep	Nummer	Schakelaar ON
Grupo	Número	Interruptor ON	Grupo	Número	Interruptor ON	Grupo	Número	Interruptor ON	Grupo	Número	Interruptor ON
Gruppo	Numero	Interruttore ON	Gruppo	Numero	Interruttore ON	Gruppo	Numero	Interruttore ON	Gruppo	Numero	Interruttore ON
Grupp	Nummer	Brytare ON	Grupp	Nummer	Brytare ON	Grupp	Nummer	Brytare ON	Grupp	Nummer	Brytare ON
Gruppe	Nummer	Skifter ON	Gruppe	Nummer	Skifter ON	Gruppe	Nummer	Skifter ON	Gruppe	Nummer	Skifter ON
1 (1)	1 ... 4	- 2 3 - 5 - 7 -	6 (1)	1 ... 4	1 - - 4 - - 7 -	11 (1)	1 ... 4	- - - 4 - 6 - 8	16 (1)	1 ... 4	- 2 - - 5 - - -
(2)	5 ... 8	- - 3 - 5 - 7 -	(2)	5 ... 8	- 2 - 4 - - 7 -	(2)	5 ... 8	1 - - - - 6 - 8	(2)	5 ... 8	- - - - 5 - - -
(3)	9 ... 12	1 - - 4 5 - 7 -	(3)	9 ... 12	- - - 4 - - 7 -	(3)	9 ... 12	- 2 - - - 6 - 8	(3)	9 ... 12	1 - 3 - - 6 - -
(4)	13 ... 16	- 2 - 4 5 - 7 -	(4)	13 ... 16	1 - - - - 7 -	(4)	13 ... 16	- - - - 6 - 8	(4)	13 ... 16	- 2 3 - - 6 - -
2 (1)	1 ... 4	1 - - - 4 5 - 7 -	7 (1)	1 ... 4	- 2 - - - 7 -	12 (1)	1 ... 4	1 - 3 - - - 8	17*(1)	1 ... 4	- 3 - - 6 - -
(2)	5 ... 8	1 - - - 5 7 -	(2)	5 ... 8	- - - - - 7 -	(2)	5 ... 8	- 2 3 - - - 8	(2)	5 ... 8	1 - - 4 - 6 - -
(3)	9 ... 12	- 2 - - 5 7 -	(3)	9 ... 12	1 - 3 - 5 - - 8	(3)	9 ... 12	- - 3 - - - 8	(3)	9 ... 12	- 2 - 4 - 6 - -
(4)	13 ... 16	- - - - 5 7 -	(4)	13 ... 16	- 2 3 - 5 - - 8	(4)	13 ... 16	1 - - 4 - - - 8	(4)	13 ... 16	- - - 4 - 6 - -
3 (1)	1 ... 4	1 - 3 - - 6 7 -	8 (1)	1 ... 4	- - 3 - 5 - - 8	13 (1)	1 ... 4	- 2 - 4 - - - 8	18*(1)	1 ... 4	1 - - - 6 - -
(2)	5 ... 8	- 2 3 - - 6 7 -	(2)	5 ... 8	1 - - 4 5 - - 8	(2)	5 ... 8	1 - - 4 - - - 8	(2)	5 ... 8	- 2 - - - 6 - -
(3)	9 ... 12	- - 3 - - 6 7 -	(3)	9 ... 12	- 2 - 4 5 - - 8	(3)	9 ... 12	1 - - - - - 8	(3)	9 ... 12	- - - - 6 - -
(4)	13 ... 16	1 - - 4 - 6 7 -	(4)	13 ... 16	- - - 4 5 - - 8	(4)	13 ... 16	- 2 - - - - 8	(4)	13 ... 16	1 - 3 - - - -
4 (1)	1 ... 4	- 2 - 4 - 6 7 -	9 (1)	1 ... 4	1 - - - 5 - - 8	14 (1)	1 ... 4	- - - - - 8	19*(1)	1 ... 4	- 2 3 - - - -
(2)	5 ... 8	- - - 4 - 6 7 -	(2)	5 ... 8	- 2 - - 5 - - 8	(2)	5 ... 8	1 - 3 - 5 - - -	(2)	5 ... 8	- 3 - - - -
(3)	9 ... 12	1 - - - 6 7 -	(3)	9 ... 12	- - - - 5 - - 8	(3)	9 ... 12	- 2 3 - 5 - - -	(3)	9 ... 12	1 - - 4 - - - -
(4)	13 ... 16	- 2 - - - 6 7 -	(4)	13 ... 16	1 - 3 - - 6 - 8	(4)	13 ... 16	- - 3 - 5 - - -	(4)	13 ... 16	- 2 - 4 - - - -
5 (1)	1 ... 4	- - - - 6 7 -	10 (1)	1 ... 4	- 2 3 - - 6 - 8	15 (1)	1 ... 4	1 - - 4 5 - - -	20*(1)	1 ... 4	- - - 4 - - - -
(2)	5 ... 8	1 - 3 - - - 7 -	(2)	5 ... 8	- - 3 - - 6 - 8	(2)	5 ... 8	- 2 - 4 5 - - -	(2)	5 ... 8	1 - - - - - -
(3)	9 ... 12	- 2 3 - - - 7 -	(3)	9 ... 12	1 - - 4 - 6 - 8	(3)	9 ... 12	- - - 4 5 - - -	(3)	9 ... 12	- 2 - - - - -
(4)	13 ... 16	- - 3 - - - 7 -	(4)	13 ... 16	- 2 - 4 - 6 - 8	(4)	13 ... 16	1 - - - 5 - - -	(4)	13 ... 16	1 - 3 - 5 - 7 -

* nur mit Central Station 60213/60214/60215 oder / und Mobile Station 60653
 * only Central Station 60213/60214/60215 and / or Mobile Station 60653
 * seulement Central Station 60213/60214/60215 et / ou Mobile Station 60653
 * met het Central Station 60213/60214/60215 en / of Mobile Station 60653
 * sólo Central Station 60213/60214/60215 y / o Mobile Station 60653
 * solo Central Station 60213/60214/60215 e / o Mobile Station 60653
 * bara Central Station 60213/60214/60215 och / eller Mobile Station 60653
 * kun Central Station 60213/60214/60215 og / eller Mobile Station 60653

K-Gleis • K Track • Voies K • K-Rail • Vias K • traccia K • K spår • K spor
 M-Gleis • M Track • Voies M • M-Rail • Vias M • traccia M • M spår • M spor

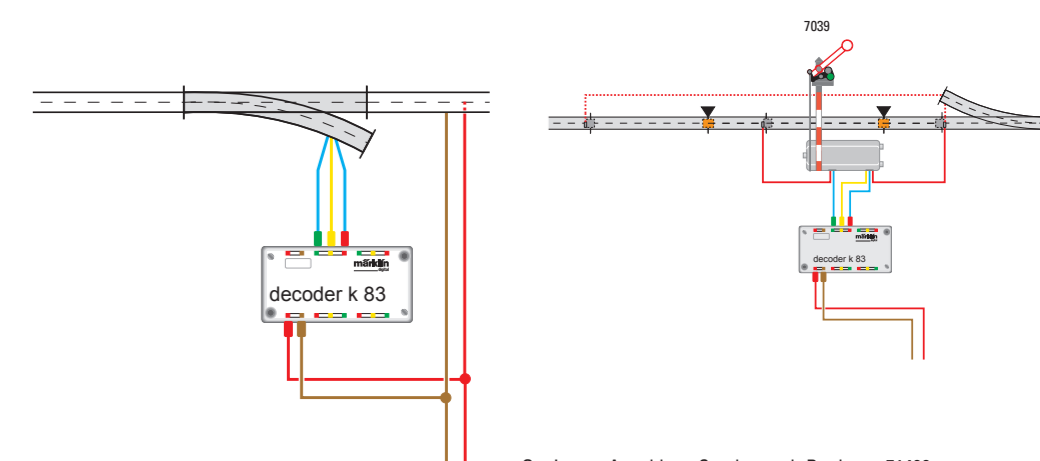

Geeignete Anschluss-Stecker und -Buchsen: 71400
 Suitable plugs and sockets for connections: 71400
 Fiches et douilles de raccordement appropriées: 71400
 Voor het aansluiten geschikte stekkers en stekkerbussen: 71400
 Enchufes y tomas de corriente adecuado: 71400
 Spine e prese adeguate: 71400
 Lämplig stickproppar och uttag: 71400
 Rigtige stik og stikkontakter: 71400