

Modell der Serie Ce 6/8 II

**39566**

<b>Inhaltsverzeichnis:</b>	
Informationen zum Vorbild	Seite 4
Sicherheitshinweise	6
Wichtige Hinweise	6
Funktionen	6
Schaltbare Funktionen	7
Parameter/Register	22
Betriebshinweise	23
Wartung und Instandhaltung	24
Ersatzteile	30

<b>Sommaire :</b>	
Informations concernant la locomotive réelle	Page 5
Remarques importantes sur la sécurité	10
Information importante	10
Fonctionnement	10
Fonctions commutables	11
Paramètre/Registre	22
Remarques sur l'exploitation	23
Entretien et maintien	24
Pièces de rechange	30

<b>Table of Contents:</b>	
Information about the prototype	Page 4
Safety Notes	8
Important Notes	8
Functions	8
Controllable Functions	9
Parameter/Register	22
Information about operation	23
Service and maintenance	24
Spare Parts	30

<b>Inhoudsopgave:</b>	
Informatie van het voorbeeld	Pagina 5
Veiligheidsvoorschriften	12
Belangrijke aanwijzing	12
Functies	12
Schakelbare functies	13
Parameter/Register	22
Opmerkingen over de werking	23
Onderhoud en handhaving	24
Onderdelen	30

<b>Indice de contenido:</b>	<b>Página</b>	<b>Innehållsförteckning:</b>	<b>Sidan</b>
Aviso de seguridad	14	Säkerhetsanvisningar	18
Notas importantes	14	Viktig information	18
Funciones	14	Funktioner	18
Funciones posibles	15	Kopplingsbara funktioner	19
Parámetro/Registro	22	Parameter/Register	22
Instrucciones de uso	23	Driftanvisningar	23
El mantenimiento	24	Underhåll och reparation	24
Recambios	30	Reservdelar	30

<b>Indice del contenido:</b>	<b>Página</b>	<b>Indholdsfortegnelse:</b>	<b>Side</b>
Avvertenze per la sicurezza	16	Vink om sikkerhed	20
Avvertenze importanti	16	Vigtige bemærkninger	20
Funzioni	16	Funktioner	20
Funzioni commutabili	17	Styrbare funktioner	21
Parametro/Registro	22	Parameter/Register	22
Avvertenze per il funzionamento	23	Brugsanvisninger	23
Manutenzione ed assistere	24	Service og reparation	24
Pezzi di ricambio	30	Reserve dele	30

### **Informationen zum Vorbild**

Mit der Elektrifizierung der Gotthardbahn um 1920 ließen die SBB neue schwere Gelenk-Lokomotiven für diese steile, kurvenreiche Strecke entwickeln. Die charakteristische Form dieser Maschinen mit den langen, flachen Vorbauten gab ihnen den legendären Namen „Krokodil“. Als Höhepunkt der Entwicklung wurde 1926 der Typ Ce 6/8 III in Dienst gestellt. Mit vier Motoren und 1.810 kW Leistung sowie dem Schrägstangenantrieb wurden die braun lackierten Lokomotiven für eine Geschwindigkeit von 65 km/h zugelassen.

1953 wurde nach Umbau des Motors die zulässige Höchstgeschwindigkeit auf 75 km/h erhöht und damit die Bezeichnung der „Krokodile“ in Be 6/8 III geändert. In den Vorjahren waren die Maschinen bereits in der neueren grünen SBB-Farbgebung umlackiert worden.

### **Information about the prototype**

With the electrification of the Gotthard route around 1920, the SBB developed new, heavy, articulated locomotives for this steep, winding rail line. The legendary name for these locomotives, “Crocodile”, came from their long, flat ends. The final development of these machines was the Ce 6/8 III, placed into service in 1926. These locomotives were painted brown, had 4 motors producing 1,810 kw of power through a jackshaft and drive rod system and had a maximum speed of 65 km/h (41 m.p.h.).

In 1953 the maximum speed was raised to 75 km/h (47 m.p.h.) after the motors were rebuilt, and the “Crocodile’s” designation was changed to Be 6/8 III. These locomotives had already been painted in the newer SBB green paint scheme prior to this time.

### **Informations concernant la locomotive réelle**

Avec l'électrification de la ligne sinueuse et à fortes pentes du St. Gotthard vers 1920, les SBB ont dû mettre au point de nouvelles motrices lourdes et articulées. Ces motrices typiques, caractérisées par leurs longs capots plats, reçurent le nom légendaire de «Crocodile». C'est en 1926 que fut mis en service le type Ce 6/8 III; aboutissement des études. Il comporte 4 moteurs qui développent une puissance de 1.810 kW et dont la transmission est assurée par des bielles obliques. Ces motrices brunes étaient limitées à 65 km/h.

En 1953, après modernisation des moteurs, la vitesse maxima fut portée à 75 km/h et leur nouvelle numérotation devint Be 6/8 III. Signalons qu'avant cette renumérotation, les «Crocodiles» avaient une livrée verte, la nouvelle couleur SBB.

### **Informatie van het voorbeeld**

Met de electrificatie van de Gotthard-lijn rond 1920 lieten de SBB nieuwe zware gelede locomotieven voor dit steile en bochtige traject ontwikkelen. De karakteristieke vorm van deze machines met hun lange en large neuzen bezorgde hen de legendarische naam "Krokodil". Als hoogtepunt bij de ontwikkeling werd in 1926 het type Ce 6/8 III in dienst gesteld. Met vier motoren en een vermogen van 1.810 kW alsmede de schuingeplaatste stangen-aandrijving werden de bruingelakte locomotieven toegelaten voor een snelheid tot 65 km/u.

Na ombouw van de motor werd in 1953 de toelaatbare max. snelheid tot 75 km/u verhoogd en werd de type-aanduiding van de "Krokodillen" in Be 6/8 III veranderd. Voordien waren de machines reeds in de nieuwe groene SBB-kleurstelling omgeschilderd.

## Sicherheitshinweise





- Die Lok darf nur mit einem dafür bestimmten Betriebssystem (Märklin Wechselstrom, Märklin Delta, Märklin Digital oder Märklin Systems) eingesetzt werden.
- Nur Schaltnetzteile und Transformatoren verwenden, die Ihrer örtlichen Netzspannung entsprechen.
- Die Lok darf nur aus einer Leistungsquelle versorgt werden.
- Beachten Sie unbedingt die Sicherheitshinweise in der Bedienungsanleitung zu Ihrem Betriebssystem.
- Für den konventionellen Betrieb der Lok muss das Anschlussgleis entstört werden. Dazu ist das Entstörset 74046 zu verwenden. Für Digitalbetrieb ist das Entstörset nicht geeignet.
- Setzen Sie das Modell keiner direkten Sonneneinstrahlung, starken Temperaturschwankungen oder hoher Luftfeuchtigkeit aus.
- **ACHTUNG!** Funktionsbedingte scharfe Kanten und Spitzen.

## Wichtige Hinweise

- Die Bedienungsanleitung und die Verpackung sind Bestandteile des Produktes und müssen deshalb aufbewahrt sowie bei Weitergabe des Produktes mitgegeben werden.
- Wartung, Instandhaltung und Reparaturen dürfen nur durch Erwachsene durchgeführt werden.
- Für Reparaturen oder Ersatzteile wenden Sie sich bitte an Ihren Märklin-Fachhändler.
- Gewährleistung und Garantie gemäß der beiliegenden Garantieurkunde.
- Entsorgung: [www.maerklin.com/en/imprint.html](http://www.maerklin.com/en/imprint.html)

## Funktionen

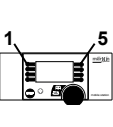
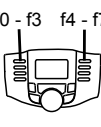
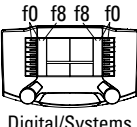
- Erkennung der Betriebsart: automatisch.
- Einstellbare Adressen:  
**1-80** (Control Unit 6021/Mobile Station 60651/652)  
**1-255** (Central Station 6021x/Mobile Station 60653)
- Adresse ab Werk: **68**  
Name ab Werk: **Ce 6/8 II 14271**
- Veränderbare Anfahr-/Bremsverzögerung (simultan) (ABV). Veränderbare Höchstgeschwindigkeit.
- Einstellen der Lokparameter (Adresse, Anfahr-/Bremsverzögerung, Höchstgeschwindigkeit):  
Über Control Unit, Mobile Station oder Central Station.
- Fahrtrichtungsabhängige Stirnbeleuchtung.
- Spielmodus Lokführer
- Weiterführende Erläuterungen zum Spielmodus finden Sie in der ergänzenden Anleitung (beiliegend).
- Im Analogbetrieb stehen nur die Fahr- und Lichtwechselfunktionen zur Verfügung.

Schaltbare Funktionen					 Digital/Systems
Spitzensignal	function/off			Funktion f0	Funktion f0
Schlusslicht rot	f1	Funktion 1	Funktion 8	Funktion f1	Funktion f1
Geräusch: Betriebsgeräusch	f2	Funktion 2	Funktion 3	Funktion f2	Funktion f2
Geräusch: Lokpfeife lang	f3	Funktion 3	Funktion 4	Funktion f3	Funktion f3
ABV aus	f4	Funktion 4	Funktion 2	Funktion f4	Funktion f4
Geräusch: Bremsenquietschen aus	—	—	Funktion 1	Funktion f5	Funktion f5
Geräusch: Lokpfeife kurz	—	—	Funktion 5	Funktion f7	Funktion f7
Geräusch: Ankuppeln (Puffer an Puffer)	—	—	Funktion 6	Funktion f9	Funktion f9
Geräusch: Pressluft	—	—	Funktion 7	Funktion f11	Funktion f11
Geräusch: Lüfter	—	—	—	Funktion f12	Funktion f12
Geräusch: Luftpresser	—	—	—	Funktion f13	Funktion f13
Geräusch: Pantograph	—	—	—	Funktion f14	Funktion f14
Geräusch: Bremsenquietschen aus *	—	—	—	Funktion f15	Funktion f15

\* nur für „Spielewelt“; nicht verschieben (nicht mappen)

## Safety Notes

- This locomotive is to be used only with an operating system designed for it (Märklin AC, Märklin Delta, Märklin Digital or Märklin Systems).
- Use only switched mode power supply units and transformers that are designed for your local power system.
- This locomotive must never be supplied with power from more than one transformer.
- Pay close attention to the safety notes in the instructions for your operating system.
- The feeder track must be equipped to prevent interference with radio and television reception, when the locomotive is to be run in conventional operation. The 74046 interference suppression set is to be used for this purpose.
- Do not expose the model to direct sunlight, extreme changes in temperature, or high humidity.
- **WARNING!** Sharp edges and points required for operation.





## Important Notes

- The operating instructions and the packaging are a component part of the product and must therefore be kept as well as transferred along with the product to others.
- Maintenance, servicing, and repairs may only be done by adults.
- Please see your authorized Märklin dealer for repairs or spare parts.
- The warranty card included with this product specifies the warranty conditions.
- Disposing: [www.maerklin.com/en/imprint.html](http://www.maerklin.com/en/imprint.html)

## Functions

- Recognition of the mode of operation: automatic.
- Addresses that can be set:  
**1-80** (Control Unit 6021/Mobile Station 60651/652)  
**1-255** (Central Station 6021x/Mobile Station 60653)
- Address set at the factory: **68**  
Name set at the factory: **Ce 6/8 II 14271**
- Adjustable acceleration/braking delay (simultaneous) (ABV). Adjustable maximum speed.
- Setting the locomotive parameters (address, acceleration/braking delay, maximum speed): with the Control Unit, Mobile Station, Central Station.
- Headlights, changing over with the direction of travel.
- Mode of Operation: Locomotive Engineer
- Additional explanations about the mode of operation can be found in the supplemental instructions (included).
- Only the train control functions and headlight changeover feature are available in analog operation.

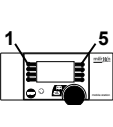
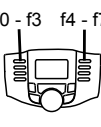
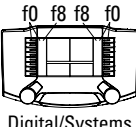

Controllable Functions					 Digital/Systems
Headlights	function/off			Function f0	Function f0
Red marker light	f1	Function 1	Function 8	Function f1	Function f1
Sound effect: Operating sounds	f2	Function 2	Function 3	Function f2	Function f2
Sound effect: long whistle blast	f3	Function 3	Function 4	Function f3	Function f3
ABV off	f4	Function 4	Function 2	Function f4	Function f4
Sound effect: Squealing brakes off	—	—	Function 1	Function f5	Function f5
Sound effect: Short whistle blast	—	—	Function 5	Function f7	Function f7
Sound effect: coupling together (buffer to buffer)	—	—	Function 6	Function f9	Function f9
Sound effect: compressed air	—	—	Function 7	Function f11	Function f11
Sound effect: Blower	—	—	—	Function f12	Function f12
Sound effect: compressor	—	—	—	Function f13	Function f13
Sound effect: pantograph	—	—	—	Function f14	Function f14
Sound effect: Squealing brakes off *	—	—	—	Function f15	Function f15

\* Only for „World of Operation“, do not move (do not map)

### Remarques importantes sur la sécurité

- La locomotive ne peut être mise en service qu'avec un système d'exploitation adéquat (Märklin AC, Märklin Delta, Märklin Digital ou Märklin Systems).
- Utiliser uniquement des convertisseurs et transformateurs correspondant à la tension du secteur local.
- La locomotive ne peut être alimentée en courant que par une seule source de courant.
- Veuillez impérativement respecter les remarques sur la sécurité décrites dans le mode d'emploi de votre système d'exploitation.
- Pour l'exploitation de la locomotive en mode conventionnel, la voie de raccordement doit être déparasitée. A cet effet, utiliser le set de déparasitage réf. 74046. Le set de déparasitage ne convient pas pour l'exploitation en mode numérique.
- Ne pas exposer le modèle à un ensoleillement direct, à de fortes variations de température ou à un taux d'humidité important.
- **ATTENTION!** Pointes et bords coupants lors du fonctionnement du produit.





### Information importante

- La notice d'utilisation et l'emballage font partie intégrante du produit ; ils doivent donc être conservés et, le cas échéant, transmis avec le produit.
- Seules des personnes adultes sont habilitées pour l'entretien, la maintenance et les réparations.
- Pour toute réparation ou remplacement de pièces, adressez-vous à votre détaillant-spécialiste Märklin.

- Garantie légale et garantie contractuelle conformément au certificat de garantie ci-joint.
- Elimination : [www.maerklin.com/en/imprint.html](http://www.maerklin.com/en/imprint.html)

### Fonctionnement

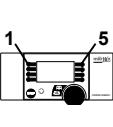
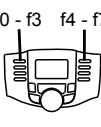
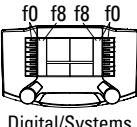
- Détection du mode d'exploitation : automatique.
- Adresses disponibles :  
**1-80** (Control Unit 6021/Mobile Station 60651/652)  
**1-255** (Central Station 6021x/Mobile Station 60653)
- Adresse encodée en usine: **68**  
Nom en codee en usine: **Ce 6/8 II 14271**
- Temporisation d'accélération et de freinage réglable (les 2 simultanément) (ABV). Vitesse maximale réglable.
- Réglage des paramètres de la loco (adresse, temporisation accélér.-freinage, vitesse maximale) : via Control Unit, Mobile Station ou Central Station.
- Feux de signalisation avec inversion selon sens de marche.
- Mode de jeu «Conducteur de train»
- Vous trouverez de plus amples informations concernant le mode de jeu dans la notice complémentaire (ci-jointe).
- En mode d'exploitation analogique, seules les fonctions relatives à la conduite et à l'inversion des feux sont disponibles.

Fonctions commutables				f0 - f3 f4 - f7 	 Digital/Systems
Fanal éclairage	function/off			Fonction f0	Fonction f0
Feu de fin de convoi rouge	f1	Fonction 1	Fonction 8	Fonction f1	Fonction f1
Bruitage : Bruit d'exploitation	f2	Fonction 2	Fonction 3	Fonction f2	Fonction f2
Bruitage : Sifflet longueur	f3	Fonction 3	Fonction 4	Fonction f3	Fonction f3
ABV désactivé	f4	Fonction 4	Fonction 2	Fonction f4	Fonction f4
Bruitage : Grincement de freins désactivé	—	—	Fonction 1	Fonction f5	Fonction f5
Bruitage : Sifflet court	—	—	Fonction 5	Fonction f7	Fonction f7
Bruitage : Attelage (tampons joints)	—	—	Fonction 6	Fonction f9	Fonction f9
Bruitage : Air comprimé	—	—	Fonction 7	Fonction f11	Fonction f11
Bruitage : Ventilateur	—	—	—	Fonction f12	Fonction f12
Bruitage : Compresseur	—	—	—	Fonction f13	Fonction f13
Bruitage : Pantographe	—	—	—	Fonction f14	Fonction f14
Bruitage : Grincement de freins désactivé *	—	—	—	Fonction f15	Fonction f15

\* Valable uniquement pour «univers ludique», ne pas déplacer (pas de mapping)

## Veiligheidsvoorschriften





- De loc mag alleen met een daarvoor bestemd bedrijfs-systeem (Märklin AC, Märklin Delta, Märklin digitaal of Märklin Systems) gebruikt worden.
- Alleen net-adapters en transformatoren gebruiken waarvan de aangegeven netspanning overeenkomt met de netspanning ter plaatse.
- De loc mag niet vanuit meer dan één stroomvoorziening gelijktijdig gevoed worden.
- Lees ook aandachtig de veiligheidsvoorschriften in de gebruiksaanwijzing van uw bedrijfssysteem.
- Voor het conventionele bedrijf met de loc dient de aansluitrail te worden ontstoort. Hiervoor dient men de ontstoor-set 74046 te gebruiken. Voor het digitale bedrijf is deze ontstoor-set niet geschikt.
- Stel het model niet bloot aan in directe zonnestraling, sterke temperatuurwisselingen of hoge luchtvochtigheid.
- **OPGEPAST!** Functionele scherpe kanten en punten.

## Belangrijke aanwijzing

- De gebruiksaanwijzing en de verpakking zijn een bestand-deel van het product en dienen derhalve bewaard en meegeleverd te worden bij het doorgeven van het product.
- Onderhoud, herstellingen en reparaties mogen alleen door volwassenen uitgevoerd worden.
- Voor reparatie of onderdelen kunt u zich tot uw Märklin handelaar wenden.
- Vrijwaring en garantie overeenkomstig het bijgevoegde garantiebewijs.
- Afdanken: [www.maerklin.com/en/imprint.html](http://www.maerklin.com/en/imprint.html)

## Funcities

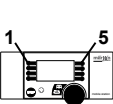
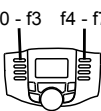
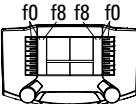
- Herkenning van het bedrijfssysteem: automatisch.
- Instelbare adressen:  
**1-80** (Control Unit 6021/Mobile Station 60651/652)  
**1-255** (Central Station 6021x/Mobile Station 60653)
- Vanaf de fabriek ingesteld: **68**  
Naam af de fabriek: **Ce 6/8 II 14271**
- Instelbare optrek- / afremvertraging (simultaan) (ABV).  
Instelbare maximumsnelheid.
- Instellen van de locomotiefparameters (adres, optrek-afremvertraging, maximumsnelheid): d.m.v. Control Unit, Mobile Station of Central Station.
- Rijrichtingafhankelijke frontseinen.
- Speelmodus machinist
- Verdere aanwijzingen voor deze speelmodus vindt u in de bijgevoegde uitgebreide gebruiksaanwijzing.
- In analoogbedrijf zijn alleen de rij- en lichtwissel-functies beschikbaar.

Schakelbare functies					 Digital/Systems
Frontverlichting	function/off			Functie f0	Functie f0
Sluitlicht rood	f1	Functie 1	Functie 8	Functie f1	Functie f1
Geluid: bedrijfsgeluiden	f2	Functie 2	Functie 3	Functie f2	Functie f2
Geluid: fluit lang	f3	Functie 3	Functie 4	Functie f3	Functie f3
ABV uit	f4	Functie 4	Functie 2	Functie f4	Functie f4
Geluid: piepende remmen uit	—	—	Functie 1	Functie f5	Functie f5
Geluid: fluit kort	—	—	Functie 5	Functie f7	Functie f7
Geluid: aankoppelen (buffer aan buffer)	—	—	Functie 6	Functie f9	Functie f9
Geluid: perslucht	—	—	Functie 7	Functie f11	Functie f11
Geluid: ventilator	—	—	—	Functie f12	Functie f12
Geluid: compressor	—	—	—	Functie f13	Functie f13
Geluid : pantograaf	—	—	—	Functie f14	Functie f14
Geluid: piepende remmen uit *	—	—	—	Functie f15	Functie f15

\* alleen voor "Speelwereld", niet verschuiven (niet mappen)

## Aviso de seguridad

- La locomotora solamente debe funcionar en un sistema de corriente propio (Märklin AC – Märklin Delta – Märklin Digital o Märklin Systems).
- Emplear únicamente fuentes de alimentación conmutadas y transformadores que sean de la tensión de red local.
- La alimentación de la locomotora deberá realizarse desde una sola fuente de suministro.
- Observe bajo todos los conceptos, las medidas de seguridad indicadas en las instrucciones de su sistema de funcionamiento.
- Para el funcionamiento convencional de la locomotora deben suprimirse las interferencias en la vía de conexión de la alimentación. Para ello debe emplearse el set supresor de interferencias 74046. El set supresor de interferencias no es adecuado para el funcionamiento en modo digital.
- No exponer el modelo en miniatura a la radiación solar directa, a oscilaciones fuertes de temperatura o a una humedad del aire elevada.
- **¡ATENCIÓN!** Esquinas y puntas afiladas condicionadas a la función.





## Notas importantes

- Las instrucciones de empleo y el embalaje forman parte íntegra del producto y, por este motivo, deben guardarse y entregarse junto con el producto en el caso de venderlo o transmitirlo a otro.
- El mantenimiento, la conservación y las reparaciones deben ser realizadas siempre por adultos.
- Para reparaciones o recambios contacte con su proveedor Märklin especializado.

- Responsabilidad y garantía conforme al documento de garantía que se adjunta.
- Eliminación: [www.maerklin.com/en/imprint.html](http://www.maerklin.com/en/imprint.html)

## Funciones

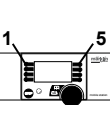
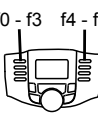
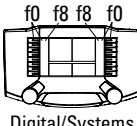
- Reconocimiento del sistema: automático.
- Códigos disponibles:  
**1-80** (Control Unit 6021/Mobile Station 60651/652)  
**1-255** (Central Station 6021x/Mobile Station 60653)
- Código de fábrica: **68**  
Nombre de fábrica: **Ce 6/8 II 14271**
- Arranque y frenado variable (simultáneo) (ABV). Velocidad máxima variable.
- Fijar parámetros de la locomotora (código, arranque y frenado, velocidad máxima): por el Control Unit, Mobile Station o Central Station.
- Faros frontales dependientes del sentido de marcha.
- Modo de juego Maquinista
- Encontrará explicaciones adicionales sobre el modo de juego en las instrucciones complementarias (adjuntas).
- En funcionamiento en modo analógico están disponibles únicamente las funciones de tracción y de alternancia de luces.

<b>Funciones posibles</b>					 Digital/Systems
Faros frontales	function/off			Función f0	Función f0
Luces de cola rojas	f1	Función 1	Función 8	Función f1	Función f1
Ruido: ruido de explotación	f2	Función 2	Función 3	Función f2	Función f2
Ruido del silbido larga	f3	Función 3	Función 4	Función f3	Función f3
ABV apagado	f4	Función 4	Función 2	Función f4	Función f4
Ruido: desconectar chirrido de los frenos	—	—	Función 1	Función f5	Función f5
Ruido del silbido corta	—	—	Función 5	Función f7	Función f7
Ruido: enganche de coches/vagones (tope contra tope)	—	—	Función 6	Función f9	Función f9
Ruido: aire comprimido	—	—	Función 7	Función f11	Función f11
Ruido: ventilador	—	—	—	Función f12	Función f12
Ruido: compresor	—	—	—	Función f13	Función f13
Ruido: pantógrafo	—	—	—	Función f14	Función f14
Ruido: Desconectar chirrido de los frenos *	—	—	—	Función f15	Función f15

\* sólo para el „Mundo de Juegos“, no deslizar (no mapear)

## Avvertenze per la sicurezza

- Tale locomotiva deve essere impiegata soltanto con un sistema di funzionamento adeguato per questa (Märklin AC, Märklin Delta, Märklin Digital oppure Märklin Systems).
- Impiegare soltanto alimentatori „switching“ e trasformatori che corrispondono alla Vostra tensione di rete locale.
- La locomotiva non deve venire alimentata nello stesso tempo con più di una sorgente di potenza.
- Vogliate prestare assolutamente attenzione alle avvertenze di sicurezza nelle istruzioni di impiego per il Vostro sistema di funzionamento.
- Per il funzionamento tradizionale della locomotiva il binario di alimentazione deve essere protetto dai disturbi. A tale scopo si deve impiegare il corredo antidisturbi 74046. Tale corredo antidisturbi non è adatto per il funzionamento Digital.
- Non esponete tale modello ad alcun irraggiamento solare diretto, a forti escursioni di temperatura oppure a elevata umidità dell'aria.
- **AVVERTENZA!** Per motivi funzionali i bordi e le punte sono spigolosi.

## Avvertenze importanti

- Le istruzioni di impiego e l'imballaggio costituiscono un componente sostanziale del prodotto e devono pertanto venire conservati nonché consegnati insieme in caso di ulteriore cessione del prodotto.
- Manutenzione, tenuta in efficienza e riparazioni possono venire eseguite soltanto da parte di adulti.
- Per le riparazioni o le parti di ricambio, contrattare il rivenditore Märklin.
- Prestazioni di garanzia e garanzia in conformità

all'accluso certificato di garanzia.





- Smaltimento: [www.maerklin.com/en/imprint.html](http://www.maerklin.com/en/imprint.html)

## Funzioni

- Riconoscimento del tipo di funzionamento: automatico
- Indirizzi impostabili:  
**1-80** (Control Unit 6021/Mobile Station 60651/652)  
**1-255** (Central Station 6021x/Mobile Station 60653)
- Indirizzo di fabbrica: **68**  
Nome di fabbrica: **Ce 6/8 II 14271**
- Ritardo di avviamento/frenatura modificabile (simultaneamente) (ABV).  
Velocità massima modificabile.
- Regolazione dei parametri della locomotiva (indirizzo, ritardo di avviamento/frenatura, velocità massima): tramite Control Unit, Mobile Station oppure Central Station.
- Illuminazione di testa dipendente dalla direzione di marcia.
- Modalità di Gioco Macchinista
- Ulteriori spiegazioni su tale modalità di gioco potete trovare nelle istruzioni supplementari (accluse).
- Nel funzionamento analogico si hanno a disposizione solamente le funzioni di marcia e di commutazione dei fanali.

Ulteriori spiegazioni su tale modalità di gioco potete trovare nelle istruzioni supplementari (accluse).

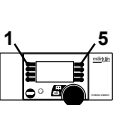
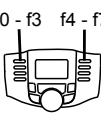
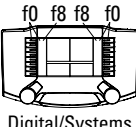

<b>Funzioni commutabili</b>					 Digital/Systems
Segnale di testa	function/off			Funzione f0	Funzione f0
Fanale di coda rosso	f1	Funzione 1	Funzione 8	Funzione f1	Funzione f1
Rumore: rumori di esercizio	f2	Funzione 2	Funzione 3	Funzione f2	Funzione f2
Rumore: fischio lunga	f3	Funzione 3	Funzione 4	Funzione f3	Funzione f3
ABV spento	f4	Funzione 4	Funzione 2	Funzione f4	Funzione f4
Rumore: stridore dei freni escluso	—	—	Funzione 1	Funzione f5	Funzione f5
Rumore: fischio breve	—	—	Funzione 5	Funzione f7	Funzione f7
Rumore: agganciamento (respingente contro respingente)	—	—	Funzione 6	Funzione f9	Funzione f9
Rumore: aria compressa	—	—	Funzione 7	Funzione f11	Funzione f11
Rumore: ventilatori	—	—	—	Funzione f12	Funzione f12
Rumore: compressore	—	—	—	Funzione f13	Funzione f13
Rumore: pantografo	—	—	—	Funzione f14	Funzione f14
Rumore: stridore dei freni escluso *	—	—	—	Funzione f15	Funzione f15

\* solo per „Mondo del Gioco“, non spostare (non mappare)

## Säkerhetsanvisningar





- Loket får endast köras med ett därtill avsett driftsystem (Märklin AC, Märklin Delta, Märklin Digital eller Märklin Systems).
- Använd endast nätadapterar och transformatorer anpassade för det lokala elnätet.
- Loket får inte samtidigt försörjas av mer än en kraftkälla.
- Beakta alltid säkerhetsanvisningarna i bruksanvisningen som hör till respektive driftsystemet.
- När motorvagnens lokdel ska köras med konventionell/ analog drift måste anlutningsskenan vara avstörd. Till detta använder man anslutningsgarnityr 74046 med avstörning och överbelastningsskydd. Avstörningsskyddet får inte användas vid digital körning.
- Modellen får inte utsättas för direkt solljus, häftiga temperaturväxlingar eller hög luftfuktighet.
- **WARNING!** Funktionsbetingade vassa kanter och spetsar.

## Viktig information

- Bruksanvisningen och förpackningen är en del av produkten och måste därför sparas och alltid medfölja produkten.
- Underhåll, service och reparationer får endast utföras av vuxna personer.
- Kontakta din Märklinfackhandlare för reparationer och reservdelar.
- Garantivillkor framgår av bifogade garantibevis.
- Hantering som avfall: [www.maerklin.com/en/imprint.html](http://www.maerklin.com/en/imprint.html)

## Funktioner

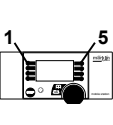
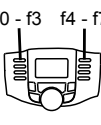
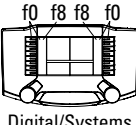
- Driftsättet igenkänns automatiskt.
- Inställbara adresser:  
**1-80** (Control Unit 6021/Mobile Station 60651/652)  
**1-255** (Central Station 6021x/Mobile Station 60653)
- Adress från tillverkaren: **68**  
Namn från tillverkaren: **Ce 6/8 II 14271**
- Acceleration/ bromsfördröjning (simultant) kan ändras (ABV).  
Toppfart kan ändras.
- Inställning av lokparametrar (Adress, acceleration/ bromsfördröjning, toppfart):  
Via Control Unit, Mobile Station eller Central Station.
- Körriktningsberoende frontbelysning.
- Spelmodus Lokförare
- Ytterligare information om spelmodus återfinns i bruksanvisningarna (bifogas).
- Vid analog körning är endast den automatiska ljusväxlingsfunktionen tillgänglig.

Kopplingsbara funktioner					 Digital/Systems
Frontstrålkastare	function/off			Funktion f0	Funktion f0
Slutljus rött	f1	Funktion 1	Funktion 8	Funktion f1	Funktion f1
Ljud: Trafikljud	f2	Funktion 2	Funktion 3	Funktion f2	Funktion f2
Ljud: Lokvissla långt	f3	Funktion 3	Funktion 4	Funktion f3	Funktion f3
ABV från	f4	Funktion 4	Funktion 2	Funktion f4	Funktion f4
Ljud: Bromsgnissel, från	—	—	Funktion 1	Funktion f5	Funktion f5
Ljud: Lokvissla kort	—	—	Funktion 5	Funktion f7	Funktion f7
Ljud: Påkoppling (buffert mot buffert)	—	—	Funktion 6	Funktion f9	Funktion f9
Ljud: Tryckluft	—	—	Funktion 7	Funktion f11	Funktion f11
Ljud: Fläktar	—	—	—	Funktion f12	Funktion f12
Ljud: Kompressor	—	—	—	Funktion f13	Funktion f13
Ljud: Pantograf	—	—	—	Funktion f14	Funktion f14
Ljud: Bromsgnissel, från *	—	—	—	Funktion f15	Funktion f15

\* endast för "simulatormiljö", flyttas ej (mappas ej)

## Vink om sikkerhed





- Lokomotivet må kun bruges med et driftssystem (Märklin AC, Märklin Delta, Märklin Digital eller Märklin Systems), der er beregnet dertil.
- Anvend kun DC-DC-omformere og transformatorer, der passer til den lokale netspænding.
- Lokomotivet må ikke forsynes fra mere end én strømkilde ad gangen.
- Vær under alle omstændigheder opmærksom på de vink om sikkerhed, som findes i brugsanvisningen for Deres driftssystem.
- Ved konventionel drift af lokomotivet skal tilslutningssporet støjdæmpes. Dertil skal anvendes støjdæmpningssættet 74046. Støjdæmpningssættet er ikke egnet til digital drift.
- Modellen må ikke udsættes for direkte sollys, store temperaturudsving eller høj luftfugtighed.
- **ADVARSEL!** Skarpe kanter og spidser pga. funktionen.

## Vigtige bemærkninger

- Betjeningsvejledning og emballage hører til produktet og skal derfor gemmes og medfølge, hvis produktet gives videre til andre.
- Service, vedligeholdelse og reparationer må kun udføres af voksne.
- For reparation eller reservedele bedes De henvende Dem til Deres Märklinforhandler.
- Garanti ifølge vedlagte garantibevis.
- Bortskafning: [www.maerklin.com/en/imprint.html](http://www.maerklin.com/en/imprint.html)

## Funktioner

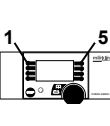
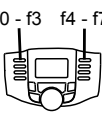
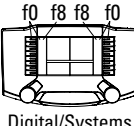
- Registrering af driftsarten: automatisk.
- Indstillelige adresser:  
**1-80** (Control Unit 6021/Mobile Station 60651/652)  
**1-255** (Central Station 6021x/Mobile Station 60653)
- Adresse af fabrik: **68**  
Navn af fabrik: **Ce 6/8 II 14271**
- Indstillelig kørsels-/bremseforsinkelse (simultan) (ABV).  
Indstillelig maksimalhastighed.
- Indstilling af lokomotivparametrene (adresse, kørsels-/bremseforsinkelse, maksimalhastighed):  
Via Control Unit, Mobile Station eller Central Station.
- Køreretningsafhængig frontbelysning.
- Operationsmodus lokomotivfører
- Yderligere bemærkninger om operationsmodus findes i den supplerende vejledning (vedlagt).
- I analogdrift er det kun køre- og lysskiftefunktionerne, der er tilgængelige.

Styrbare funktioner					 Digital/Systems
Frontbelysning	function/off			Funktion f0	Funktion f0
Slutlys rødt	f1	Funktion 1	Funktion 8	Funktion f1	Funktion f1
Lyd: Driftslyd	f2	Funktion 2	Funktion 3	Funktion f2	Funktion f2
Lyd: Lokomotivfløjte langt	f3	Funktion 3	Funktion 4	Funktion f3	Funktion f3
ABV fra	f4	Funktion 4	Funktion 2	Funktion f4	Funktion f4
Lyd: Pibende bremses fra	—	—	Funktion 1	Funktion f5	Funktion f5
Lyd: Lokomotivfløjte kort	—	—	Funktion 5	Funktion f7	Funktion f7
Lyd: Sammenkobling (buffer mod buffer)	—	—	Funktion 6	Funktion f9	Funktion f9
Lyd: Trykluft	—	—	Funktion 7	Funktion f11	Funktion f11
Lyd: Blæser	—	—	—	Funktion f12	Funktion f12
Lyd: Kompressor	—	—	—	Funktion f13	Funktion f13
Lyd: Pantograf	—	—	—	Funktion f14	Funktion f14
Lyd: Pibende bremses fra *	—	—	—	Funktion f15	Funktion f15

\* kun til „World of Operation“, må ikke forskydes (må ikke mappes)

<b>CV (Parameter) • CV (Parameter) • CV (Paramètre) •  CV (Parameter) • CV (Parámetro) • CV (Parametro) •  CV (Parameter) • CV (Parameter)</b>	<b>CV-Nr.</b>	<b>Wert • Value •  Valeur • Waarde •  Valor • Valore •  Värde • Værdi</b>
Adresse • Address • Adresse • Adres • Código • Indirizzo • Adress • Adresse	01	01 - (80)* 255
Anfahrverzögerung • Acceleration delay • Temporisation accélération • Optrekvertraging • Regulación arranque • Ritardo di avviamento • Igångsättningsreglering • Kørselsforsinkelse	03	01 - (63)* 255
Bremsverzögerung • Braking delay • Temporisation de freinage • Afremvertraging • Frenado lento • Ritardo di frenatura • Bromsfördröjning • Bremseforsinkelse	04	01 - (63)* 255
Höchstgeschwindigkeit • Maximum speed • Vitesse maximale • Maximumsneilheid • Velocidad máxima • Velocità massima • Toppfart • Maksimalhastighed	05	01 - (63)* 255
Rückstellen auf Serienwerte • Reset to series value • Remettre aux valeurs de série • Terugzetten naar serie-instellingen • Restablecer los valores de serie • Ripristinare sui valori di serie • Återställa till standardvärden • Tibagestil til serieværdien	08	08
Lautstärke • Volume • Volume haut-parleur • Volume • Volumen del sonido • Intensità del suono • Ljudstyrka • Lydstyrke	63	01 - (63)* 255

\* () = Control Unit 6021 / Mobile Station 60651/60652

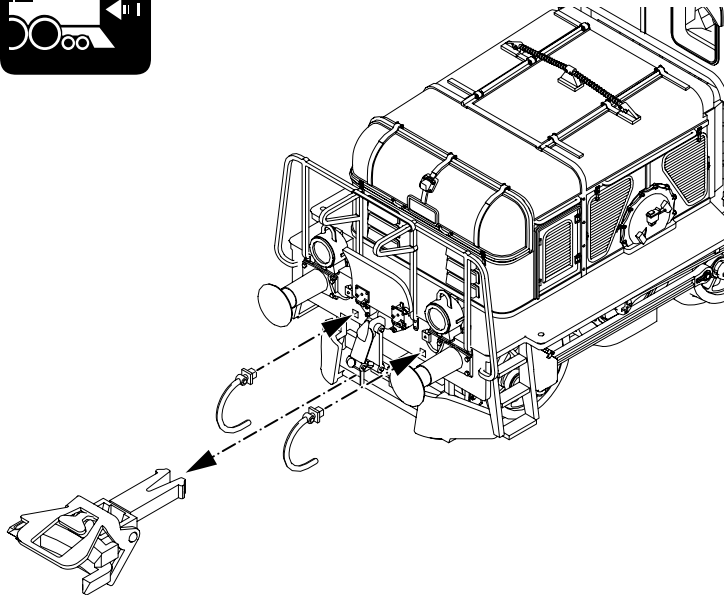

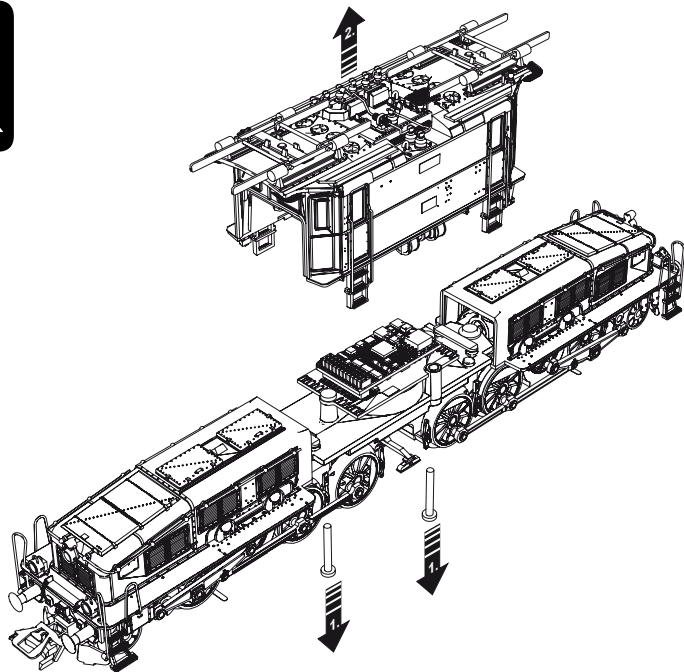



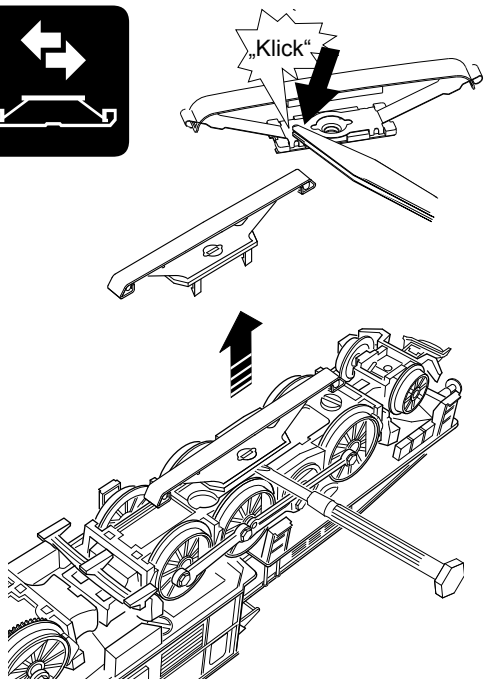
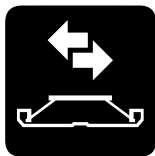
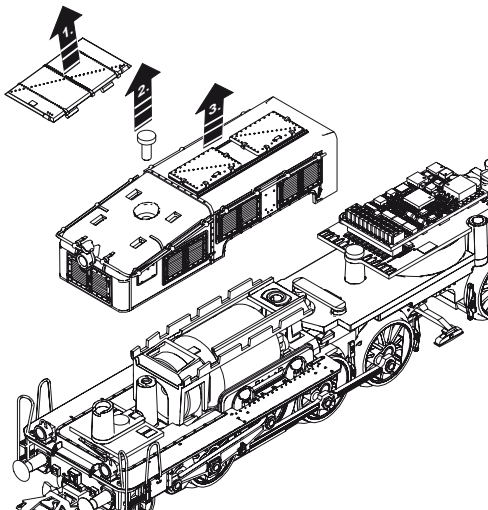

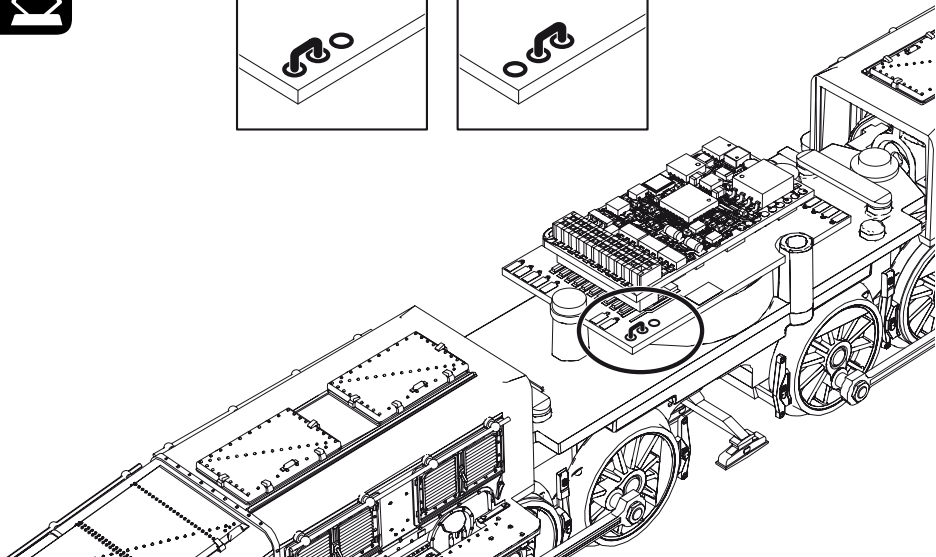
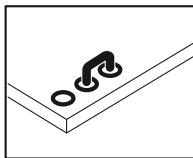
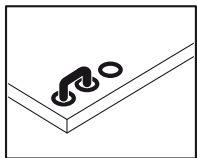
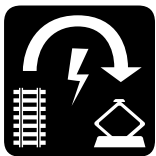

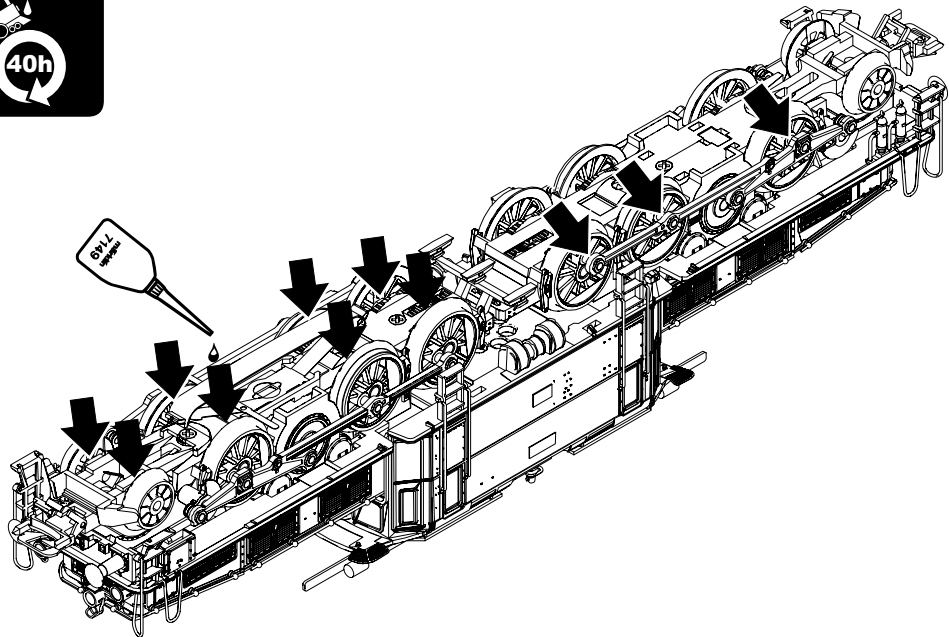



Trix 66626

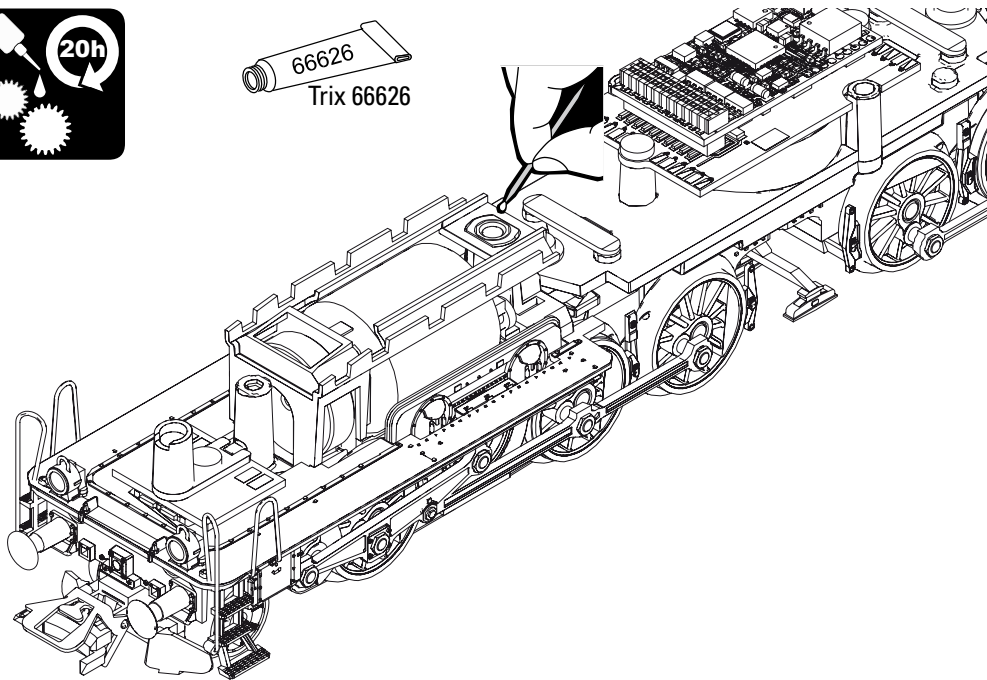

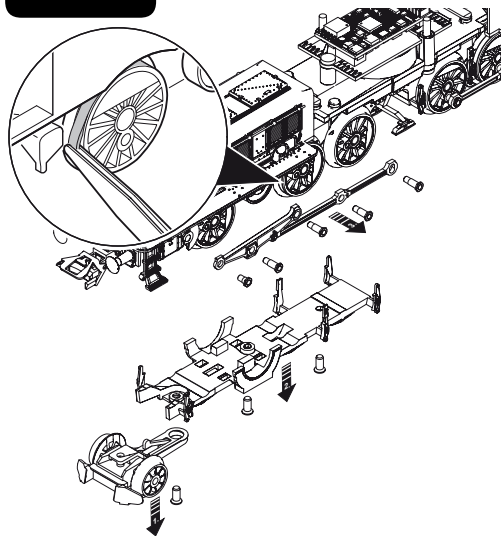
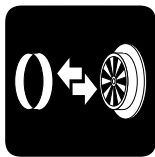
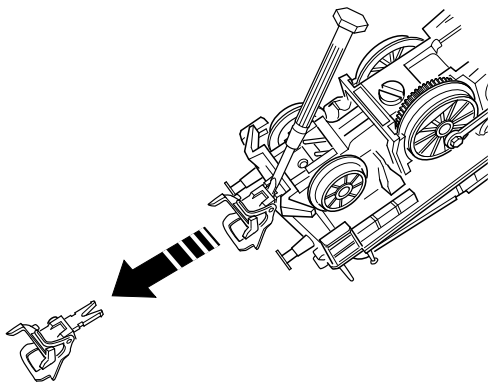

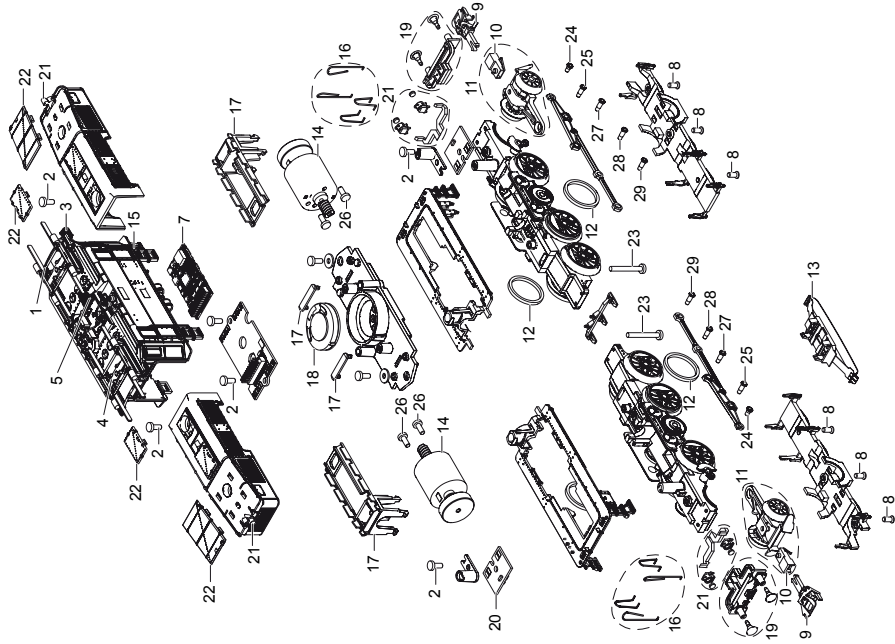

Details der Darstellung  
 können von dem  
 Modell abweichen.

1 Scherenstromabnehmer	E259 530
2 Schraube	E786 750
3 Laufbrett	E244 039
4 Isolierplatte	E259 520
5 Pfeife	E178 137
6 Schraube	—
7 Decoder	246 878
8 Schraube	E786 790
9 Kupplung	E701 630
10 Kupplungshalter	E671 860
11 Laufgestell	E191 549
12 Haftreifen	7 153
13 Schleifer	E138 079
14 Motor	E178 182
15 Handgriff	E180 280
16 Griffe Vorbau	E191 550
17 Kabelhalter, Haltebügel	E191 179
18 Lautsprecher	E168 258
19 Pufferbohle	E178 193
20 Leiterplatte Beleuchtung	E191 180
21 Laternen	E191 553
22 Deckel u. Abdeckung	E191 554
23 Schraube	E786 430
24 Sechskantansatzschraube	E180 277
25 Sechskantansatzschraube	E180 271
26 Schraube	E241 976
27 Sechskantansatzschraube	E143 781
28 Sechskantansatzschraube	E224 995
29 Sechskantansatzschraube	E499 840
Bremsleitung	E12 5149 00
Druckfeder	E214 330

Hinweis: Einige Teile werden nur ohne oder mit anderer Farbgebung angeboten.

Teile, die hier nicht aufgeführt sind, können nur im Rahmen einer Reparatur im Märklin-Reparatur-Service repariert werden.

Due to different legal requirements regarding electro-magnetic compatibility, this item may be used in the USA only after separate certification for FCC compliance and an adjustment if necessary. Use in the USA without this certification is not permitted and absolves us of any liability. If you should want such certification to be done, please contact us – also due to the additional costs incurred for this.

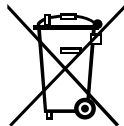

Gebr. Märklin & Cie. GmbH  
Stuttgarter Str. 55 - 57  
73033 Göppingen  
Germany  
[www.maerklin.com](http://www.maerklin.com)

  
[www.maerklin.com/en/imprint.html](http://www.maerklin.com/en/imprint.html)

249061/0215/Sm1Ef  
Änderungen vorbehalten  
© Gebr. Märklin & Cie. GmbH