

ajckids.com
planes, trains automobiles

märklin
H0



Dampflokomotive Litra N
37818

Inhaltsverzeichnis:

	Seite
Hinweise zur Inbetriebnahme	4
Sicherheitshinweise	6
Wichtige Hinweise	6
Funktionen	6
Schaltbare Funktionen	7
Parameter/Register	22
Ergänzendes Zubehör	23
Wartung und Instandhaltung	27
Ersatzteile	33

Sommaire :

	Page
Indications relatives à la mise en service	4
Remarques importantes sur la sécurité	10
Information importante	10
Fonctionnement	10
Fonctions commutables	11
Paramètre/Registre	22
Accessoires complémentaires	23
Entretien et maintien	27
Pièces de rechange	33

Table of Contents:

	Page
Notes about using this model for the first time	4
Safety Notes	8
Important Notes	8
Functions	8
Controllable Functions	9
Parameter/Register	22
Completing accessories	23
Service and maintenance	27
Spare Parts	33

Inhoudsopgave:

	Pagina
Opmerking voor de ingebruikname	4
Veiligheidsvoorschriften	12
Belangrijke aanwijzing	12
Functies	12
Schakelbare functies	13
Parameter/Register	22
Aanvullende toebehoren	23
Onderhoud en handhaving	27
Onderdelen	33

Indice de contenido:

	Página
Notas para la puesta en servicio	4
Aviso de seguridad	14
Notas importantes	14
Funciones	14
Funciones posibles	15
Parámetro/Registro	22
Accesorios complementarios	23
El mantenimiento	27
Recambios	33

Indice del contenuto:

	Pagina
Avvertenza per la messa in esercizio	4
Avvertenze per la sicurezza	16
Avvertenze importanti	16
Funzioni	16
Funzioni commutabili	17
Parametro/Registro	22
Accessori complementari	23
Manutenzione ed assistere	27
Pezzi di ricambio	33

Innehållsförteckning:

	Sidan
Anvisningar för körning med modellen	4
Säkerhetsanvisningar	18
Viktig information	18
Funktioner	18
Kopplingsbara funktioner	19
Parameter/Register	22
Ytterligare tillbehör	23
Underhåll och reparation	27
Reservdelar	33

Indholdsfortegnelse:

	Side
Henvisninger til ibrugtagning	4
Vink om sikkerhed	20
Vigtige bemærkninger	20
Funktioner	20
Styrbare funktioner	21
Parameter/Register	22
Ekstra tilbehør	23
Service og reparation	27
Reserve dele	33

Übergangsgleis/Steigung und Bogenanfang
Transfer rail/gradient and start of bend
Rail de transition/montée et début de courbe
Övergångsraíl/Steiging en boogbegin
Vía de transición/cuesta e inicio de la curva
Binario di raccordo/pendenza ed inizio della curva
Övergångsräls/stigning och början av kurva
Övergångsspor/stigning og kurvestart

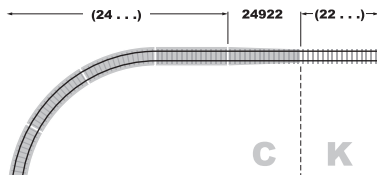
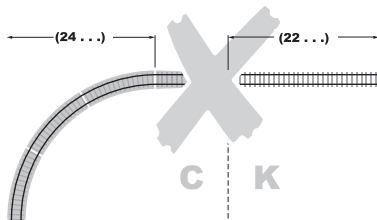

Kolbenstangenschutzrohr einsetzen
How to install the cylinder rod protector
Insérer le tube de protection de la lige de piston
Beschermhuis cilinderstang plaatsen
Colocar el tubo protector de la biela
Installazione del tubetto di protezione per l'asta dello stantuffo
Kolvstängskyddsröret monteras
Cylinderstang-beskyttelsesør indsættes

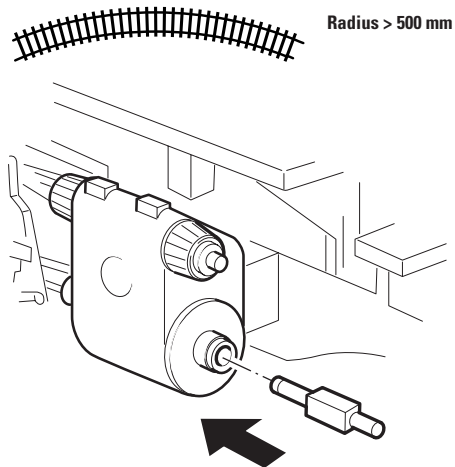



- ! Zum Verpacken den langen Tenderabstand einstellen.
- ! Extend the spacing between the locomotive and tender to the longest point for packaging purposes.
- ! Réduire l'écart avec le tender pour l'emballage.
- ! Voor het verpakken de langere tenderafstand instellen
- ! Para su embalaje, ajustar la separación larga del tender.
- ! Per l'imballaggio impostare la distanza lunga del tender.
- ! Vid återförpackning i originalboxen måste det längre avståndet till tendern ställas in.
- ! Til pakning skal den lange tenderafstand indstilles

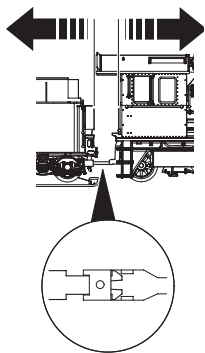

Radius < 495 mm

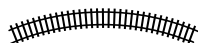
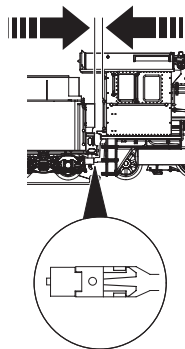
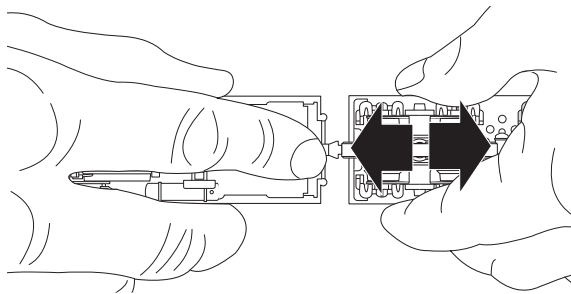

Radius > 500 mm

Sicherheitshinweise







- Die Lok darf nur mit einem dafür bestimmten Betriebssystem (Märklin AC, Märklin Delta, Märklin Digital oder Märklin Systems) eingesetzt werden.
- Nur Schaltnetzteile/Transformatoren verwenden, die Ihrer örtlichen Netzspannung entsprechen.
- Die Lok darf nur aus einer Leistungsquelle versorgt werden.
- Beachten Sie unbedingt die Sicherheitshinweise in der Bedienungsanleitung zu Ihrem Betriebssystem.
- Für den konventionellen Betrieb der Lok muss das Anschlussgleis entstört werden. Dazu ist das Entstörset 74046 zu verwenden. Für Digitalbetrieb ist das Entstörset nicht geeignet.
- **ACHTUNG!** Funktionsbedingte scharfe Kanten und Spitzen.
- Setzen Sie das Modell keiner direkten Sonneneinstrahlung, starken Temperaturschwankungen oder hoher Luftfeuchtigkeit aus.

Wichtige Hinweise

- Die Bedienungsanleitung und die Verpackung sind Bestandteile des Produktes und müssen deshalb aufbewahrt sowie bei Weitergabe des Produktes mitgegeben werden.
- Für Reparaturen oder Ersatzteile wenden Sie sich bitte an Ihren Märklin-Fachhändler.
- Entsorgung: www.maerklin.com/en/imprint.html
- Gewährleistung und Garantie gemäß der beiliegenden Garantiekunde.

Funktionen

- Erkennung der Betriebsart: automatisch.
- Einstellbare Adressen:
1-80 (Control Unit 6021/Mobile Station 60651/652)
1-255 (Central Station 6021x/Mobile Station 60653)
- Adresse ab Werk: **50**
- Mfx-Technologie für Mobile Station/Central Station.
Name ab Werk: **N 209 DSB**
- Veränderbare Anfahrverzögerung (ABV).
- Veränderbare Bremsverzögerung (ABV).
- Veränderbare Höchstgeschwindigkeit.
- Einstellen der Lokparameter (Adresse, Anfahr-/Bremsverzögerung, Höchstgeschwindigkeit): über Control Unit, Mobile Station oder Central Station.
- Fahrtrichtungsabhängige Stirnbeleuchtung.
- Im Analogbetrieb stehen nur die Fahr- und Lichtwechselfunktionen zur Verfügung.
- Rauchsatz nachrüstbar - auch für den Analogbetrieb.

Schaltbare Funktionen					 Digital/Systems
Spitzensignal	function/off			Funktion f0	Funktion f0
Rauchgenerator ¹⁾	f1	Funktion 1	Funktion 7	Funktion f1	Funktion f1
Geräusch: Betriebsgeräusch	f2	Funktion 2	Funktion 3	Funktion f2	Funktion f2
Geräusch: Lokpfeife lang	f3	Funktion 3	Funktion 4	Funktion f3	Funktion f3
ABV aus	f4	Funktion 4	Funktion 2	Funktion f4	Funktion f4
Geräusch: Bremsenquietschen, aus	—	—	Funktion 8	Funktion f5	Funktion f5
Geräusch: Luftpumpe	—	—	Funktion 1	Funktion f6	Funktion f6
Geräusch: Rangierpfeife	—	—	Funktion 5	Funktion f7	Funktion f7
Geräusch: Dampf ablassen	—	—	Funktion 6	Funktion f8	Funktion f8
Geräusch: Glocke	—	—	—	Funktion f9	Funktion f9
Geräusch: Kohle schaufeln	—	—	—	Funktion f10	Funktion f10
Geräusch: Schüttelrost	—	—	—	Funktion f11	Funktion f11
Geräusch: Injektor	—	—	—	Funktion f12	Funktion f12

1) Gehört nicht zum Lieferumfang.

Safety Notes







- This locomotive is to be used only with an operating system designed for it (Märklin AC, Märklin Delta, Märklin Digital or Märklin Systems).
- Use only switched mode power supply units and transformers that are designed for your local power system.
- This locomotive must never be supplied with power from more than one transformer.
- Pay close attention to the safety notes in the instructions for your operating system.
- The feeder track must be equipped to prevent interference with radio and television reception, when the locomotive is to be run in conventional operation. The 74046 interference suppression set is to be used for this purpose.
- **WARNING!** Sharp edges and points required for operation.
- Do not expose the model to direct sunlight, extreme changes in temperature, or high humidity.

Important Notes

- The operating instructions and the packaging are a component part of the product and must therefore be kept as well as transferred along with the product to others.
- Please see your authorized Märklin dealer for repairs or spare parts.
- Disposing: www.maerklin.com/en/imprint.html
- The warranty card included with this product specifies the warranty conditions.

Functions

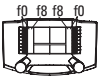
- Recognition of the mode of operation: automatic.
- Addresses that can be set:
1-80 (Control Unit 6021/Mobile Station 60651/652)
1-255 (Central Station 6021x/Mobile Station 60653)
- Address set at the factory: **50**
- Mfx technology for the Mobile Station/Central Station.
Name set at the factory: **N 209 DSB**
- Adjustable Acceleration (ABV).
- Adjustable Braking delay (ABV).
- Adjustable maximum speed.
- Setting the locomotive parameters (address, acceleration/braking delay, maximum speed): with the Control Unit, Mobile Station, Central Station.
- Headlights, changing over with the direction of travel.
- Only the train control functions and headlight changeover feature are available in analog operation.
- A smoke generator can be retrofitted to the locomotive - also for analog operation.

Controllable Functions					 Digital /Systems
Headlights	function/off			Function f0	Function f0
Smoke generator 1)	f1	Function 1	Function 7	Function f1	Function f1
Sound effect: Operating sounds	f2	Function 2	Function 3	Function f2	Function f2
Sound effect: Long whistle blast	f3	Function 3	Function 4	Function f3	Function f3
ABV off	f4	Function 4	Function 2	Function f4	Function f4
Sound effect: Squealing brakes off	—	—	Function 8	Function f5	Function f5
Sound effect: Air pump	—	—	Function 1	Function f6	Function f6
Sound effect: Short switching whistle	—	—	Function 5	Function f7	Function f7
Sound effect: Blowing off steam	—	—	Function 6	Function f8	Function f8
Sound effect: Bell	—	—	—	Function f9	Function f9
Sound effect: Coal being shoveled	—	—	—	Function f10	Function f10
Sound effect: Rocker grate	—	—	—	Function f11	Function f11
Sound effect: Injector	—	—	—	Function f12	Function f12

1) Not included in delivery scope.

Remarques importantes sur la sécurité







- La locomotive ne peut être mise en service qu'avec un système d'exploitation adéquat (Märklin AC, Märklin Delta, Märklin Digital ou Märklin Systems).
- Utiliser uniquement des convertisseurs et transformateurs correspondant à la tension du secteur local.
- La locomotive ne peut être alimentée en courant que par une seule source de courant.
- Veuillez impérativement respecter les remarques sur la sécurité décrites dans le mode d'emploi de votre système d'exploitation.
- Pour l'exploitation de la locomotive en mode conventionnel, la voie de raccordement doit être déparasitée. A cet effet, utiliser le set de déparasitage réf. 74046. Le set de déparasitage ne convient pas pour l'exploitation en mode numérique.
- **ATTENTION!** Pointes et bords coupants lors du fonctionnement du produit.
- Ne pas exposer le modèle à un ensoleillement direct, à de fortes variations de température ou à un taux d'humidité important.

Information importante

- La notice d'utilisation et l'emballage font partie intégrante du produit ; ils doivent donc être conservés et, le cas échéant, transmis avec le produit.
- Pour toute réparation ou remplacement de pièces, adressez-vous à votre détaillant-spécialiste Märklin.
- Elimination : www.maerklin.com/en/imprint.html
- Garantie légale et garantie contractuelle conformément au certificat de garantie ci-joint.

Fonctionnement

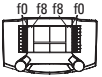
- Détection du mode d'exploitation : automatique.
- Adresses disponibles :
1-80 (Control Unit 6021/Mobile Station 60651/652)
1-255 (Central Station 6021x/Mobile Station 60653)
- Adresse encodée en usine : **50**
- Technologie mfx pour Mobile Station/Central Station.
Nom encodée en usine : **N 209 DSB**
- Temporisation d'accélération réglable (ABV).
- Temporisation de freinage réglable (ABV).
- Vitesse maximale réglable.
- Réglage des paramètres de la loco (adresse, temporisation accélér.-freinage, vitesse maximale) : via Control Unit, Mobile Station ou Central Station.
- Feux de signalisation avec inversion selon sens de marche.
- En mode d'exploitation analogique, seules les fonctions relatives à la conduite et à l'inversion des feux sont disponibles.
- Installation ultérieure d'un générateur de fumée possible - également pour exploitation analogique.

Fonctions commutables					 Digital/Systems
Fanal	function/off			Fonction f0	Fonction f0
Générateur de fumée ¹⁾	f1	Fonction 1	Fonction 7	Fonction f1	Fonction f1
Bruitage : Bruit d'exploitation	f2	Fonction 2	Fonction 3	Fonction f2	Fonction f2
Bruitage : sifflet longueur	f3	Fonction 3	Fonction 4	Fonction f3	Fonction f3
ABV désactivé	f4	Fonction 4	Fonction 2	Fonction f4	Fonction f4
Bruitage : Grincement de freins, désactivé	—	—	Fonction 8	Fonction f5	Fonction f5
Bruitage : Compresseur	—	—	Fonction 1	Fonction f6	Fonction f6
Bruitage : Sifflet pour manœuvre court	—	—	Fonction 5	Fonction f7	Fonction f7
Bruitage : Échappement de la vapeur	—	—	Fonction 6	Fonction f8	Fonction f8
Bruitage : Cloche	—	—	—	Fonction f9	Fonction f9
Bruitage : Pelletage du charbon	—	—	—	Fonction f10	Fonction f10
Bruitage : Grille à secousses	—	—	—	Fonction f11	Fonction f11
Bruitage : Injecteur	—	—	—	Fonction f12	Fonction f12

1) Ne fait pas partie de la fourniture.

Veiligheidsvoorschriften







- De loc mag alleen met een daarvoor bestemd bedrijfssysteem (Märklin AC, Märklin Delta, Märklin digitaal of Märklin Systems) gebruikt worden.
- Alleen net-adapters en transformatoren gebruiken waarvan de aangegeven netspanning overeenkomt met de netspanning ter plaatse.
- De loc mag niet vanuit meer dan één stroomvoorziening gelijktijdig gevoed worden.
- Lees ook aandachtig de veiligheidsvoorschriften in de gebruiksaanwijzing van uw bedrijfssysteem.
- Voor het conventionele bedrijf met de loc dient de aansluitrail te worden ontstoort. Hiervoor dient men de ontstoor-set 74046 te gebruiken. Voor het digitale bedrijf is deze ontstoor-set niet geschikt.
- **OPGEPAST!** Functionele scherpe kanten en punten.
- Stel het model niet bloot aan in directe zonnestraling, sterke temperatuurwisselingen of hoge luchtvochtigheid.

Belangrijke aanwijzing

- De gebruiksaanwijzing en de verpakking zijn een bestanddeel van het product en dienen derhalve bewaard en meegeleverd te worden bij het doorgeven van het product.
- Voor reparatie of onderdelen kunt u zich tot uw Märklin handelaar wenden.
- Afdanken: www.maerklin.com/en/imprint.html
- Vrijwaring en garantie overeenkomstig het bijgevoegde garantiebewijs.

Functionies

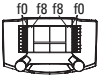
- Herkenning van het bedrijfssysteem: automatisch.
- Instelbare adressen:
1-80 (Control Unit 6021/Mobile Station 60651/652)
1-255 (Central Station 6021x/Mobile Station 60653)
- Vanaf de fabriek ingesteld: **50**
- Mfx-technologie voor het Mobile Station/Central Station.
Naam af de fabriek: **N 209 DSB**
- Instelbare optrekvertraging (ABV).
- Instelbare afremvertraging (ABV).
- Instelbare maximumsnelheid.
- Instellen van de locomotiefparameters (adres, optrek-/ afremvertraging, maximumsnelheid): d.m.v. Control Unit, Mobile Station of Central Station.
- Rijrichtingafhankelijke frontseinen.
- In analoogbedrijf zijn alleen de rij- en lichtwissel-functionies beschikbaar.
- Rookgenerator nadien in te bouwen - ook voor analoog bedrijf.

Schakelbare functies					 Digital/Systems
Frontsein	function/off			Functie f0	Functie f0
Rookgenerator ¹⁾	f1	Functie 1	Functie 7	Functie f1	Functie f1
Geluid: bedrijfsgeluiden	f2	Functie 2	Functie 3	Functie f2	Functie f2
Geluid: fluit lang	f3	Functie 3	Functie 4	Functie f3	Functie f3
ABV uit	f4	Functie 4	Functie 2	Functie f4	Functie f4
Geluid: piepende remmen, uit	—	—	Functie 8	Functie f5	Functie f5
Geluid: luchtpomp	—	—	Functie 1	Functie f6	Functie f6
Geluid: rangeerfluit kort	—	—	Functie 5	Functie f7	Functie f7
Geluid: stoom afblazen	—	—	Functie 6	Functie f8	Functie f8
Geluid: luidklok	—	—	—	Functie f9	Functie f9
Geluid: kolenscheppen	—	—	—	Functie f10	Functie f10
Geluid: schudrooster	—	—	—	Functie f11	Functie f11
Geluid: injector	—	—	—	Functie f12	Functie f12

1) Maakt geen deel uit van het leveringspakket.

Aviso de seguridad







- La locomotora solamente debe funcionar en un sistema de corriente propio (Märklin AC – Märklin Delta – Märklin Digital o Märklin Systems).
- Emplear únicamente fuentes de alimentación conmutadas y transformadores que sean de la tensión de red local.
- La locomotora no deberá recibir corriente eléctrica mas que de un solo punto de abasto.
- Observe bajo todos los conceptos, las medidas de seguridad indicadas en las instrucciones de su sistema de funcionamiento.
- Para el funcionamiento convencional de la locomotora deben suprimirse las interferencias en la vía de conexión de la alimentación. Para ello debe emplearse el set supresor de interferencias 74046. El set supresor de interferencias no es adecuado para el funcionamiento en modo digital.
- **¡ATENCIÓN!** Esquinas y puntas afiladas condicionadas a la función.
- No exponer el modelo en miniatura a la radiación solar directa, a oscilaciones fuertes de temperatura o a una humedad del aire elevada.

Notas importantes

- Las instrucciones de empleo y el embalaje forman parte íntegra del producto y, por este motivo, deben guardarse y entregarse junto con el producto en el caso de venderlo o transmitirlo a otro.
- Para reparaciones o recambios contacte con su proveedor Märklin especializado.
- Eliminación: www.maerklin.com/en/imprint.html
- Responsabilidad y garantía conforme al documento de garantía que se adjunta.

Funciones

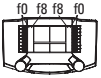
- Reconocimiento del sistema: automático.
- Códigos disponibles:
1-80 (Control Unit 6021/Mobile Station 60651/652)
1-255 (Central Station 6021x/Mobile Station 60653)
- Código de fábrica: **50**
- Tecnología mfx para la Mobile Station/Central Station.
Nombre de fábrica: **N 209 DSB**
- Arranque lento variable (ABV).
- Frenado lento variable (ABV).
- Velocidad máxima variable.
- Fijar parámetros de la locomotora (código, arranque y frenado, velocidad máxima): por el Control Unit, Mobile Station o Central Station.
- Faros frontales dependientes del sentido de marcha.
- En funcionamiento en modo analógico están disponibles únicamente las funciones de tracción y de alternancia de luces.
- Kit de humo equipable posteriormente, incluso para funcionamiento en modo analógico.

Funciones posibles					 Digital/Systems
Faros frontales	function/off			Función f0	Función f0
Generador de humo ¹⁾	f1	Función 1	Función 7	Función f1	Función f1
Ruido: Ruido de explotación	f2	Función 2	Función 3	Función f2	Función f2
Ruido del silbido larga	f3	Función 3	Función 4	Función f3	Función f3
ABV apagado	f4	Función 4	Función 2	Función f4	Función f4
Ruido: Chirrido de los frenos apagado	—	—	Función 8	Función f5	Función f5
Ruido: Bomba de aire	—	—	Función 1	Función f6	Función f6
Ruido: Silbato de maniobras corta	—	—	Función 5	Función f7	Función f7
Ruido: Purgar vapor	—	—	Función 6	Función f8	Función f8
Ruido: Campana	—	—	—	Función f9	Función f9
Ruido: Cargar carbón con pala	—	—	—	Función f10	Función f10
Ruido: Parrilla vibratoria	—	—	—	Función f11	Función f11
Ruido: Inyector	—	—	—	Función f12	Función f12

1) No está incluido en el conjunto de piezas suministradas.

Avvertenze per la sicurezza







- Tale locomotiva deve essere impiegata soltanto con un sistema di funzionamento adeguato per questa (Märklin AC, Märklin Delta, Märklin Digital oppure Märklin Systems).
- Impiegare soltanto alimentatori "switching" e trasformatori che corrispondono alla Vostra tensione di rete locale.
- La locomotiva non deve venire alimentata nello stesso tempo con più di una sorgente di potenza.
- Vogliate prestare assolutamente attenzione alle avvertenze di sicurezza nelle istruzioni di impiego per il Vostro sistema di funzionamento.
- Per il funzionamento tradizionale della locomotiva il binario di alimentazione deve essere protetto dai disturbi. A tale scopo si deve impiegare il corredo antidisturbi 74046. Tale corredo antidisturbi non è adatto per il funzionamento Digital.
- **AVVERTENZA!** Per motivi funzionali i bordi e le punte sono spigolosi.
- Non esponete tale modello ad alcun irraggiamento solare diretto, a forti escursioni di temperatura oppure a elevata umidità dell'aria.

Avvertenze importanti

- Le istruzioni di impiego e l'imballaggio costituiscono un componente sostanziale del prodotto e devono pertanto venire conservati nonché consegnati insieme in caso di ulteriore cessione del prodotto.
- Per le riparazioni o le parti di ricambio, contrattare il rivenditore Märklin.
- Smaltimento: www.maerklin.com/en/imprint.html
- Prestazioni di garanzia e garanzia in conformità all'accluso certificato di garanzia.

Funzioni

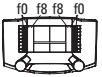
- Riconoscimento del tipo di funzionamento: automatico.
- Indirizzi impostabili:
1-80 (Control Unit 6021/Mobile Station 60651/652)
1-255 (Central Station 6021x/Mobile Station 60653)
- Indirizzo di fabbrica: **50**
- Tecnologia Mfx per Mobile Station/Central Station.
Nome di fabbrica: **N 209 DSB**
- Ritardo di avviamento modificabile (ABV).
- Ritardo di frenatura modificabile (ABV).
- Velocità massima modificabile.
- Regolazione dei parametri della locomotiva (indirizzo, ritardo di avviamento/frenatura, velocità massima): tramite Control Unit, Mobile Station oppure Central Station.
- Illuminazione di testa dipendente dalla direzione di marcia.
- Nel funzionamento analogico si hanno a disposizione solamente le funzioni di marcia e di commutazione dei fanali.
- Apparato fumogeno equipaggiabile in seguito - anche per il funzionamento analogico.

Funzioni commutabili					 Digital/Systems
Illuminazione di testa	function/off			Funzione f0	Funzione f0
Apparato fumogeno ¹⁾	f1	Funzione 1	Funzione 7	Funzione f1	Funzione f1
Rumore: rumori di esercizio	f2	Funzione 2	Funzione 3	Funzione f2	Funzione f2
Rumore: fischio lunga	f3	Funzione 3	Funzione 4	Funzione f3	Funzione f3
ABV spento	f4	Funzione 4	Funzione 2	Funzione f4	Funzione f4
Rumore: stridore dei freni spento	—	—	Funzione 8	Funzione f5	Funzione f5
Rumore: compressore dell'aria	—	—	Funzione 1	Funzione f6	Funzione f6
Rumore: fischio di manovra breve	—	—	Funzione 5	Funzione f7	Funzione f7
Rumore: scarico del vapore	—	—	Funzione 6	Funzione f8	Funzione f8
Rumore: campana	—	—	—	Funzione f9	Funzione f9
Rumore: spalatura del carbone	—	—	—	Funzione f10	Funzione f10
Rumore: griglia a scuotimento	—	—	—	Funzione f11	Funzione f11
Rumore: iniettore	—	—	—	Funzione f12	Funzione f12

1) Non incl. nella fornitura.

Säkerhetsanvisningar







- Loket får endast köras med ett därtill avsett driftsystem (Märklin AC, Märklin Delta, Märklin Digital eller Märklin Systems).
- Använd endast nätadapterar och transformatorer anpassade för det lokala elnätet.
- Loket får inte samtidigt försörjas av mer än en kraftkälla.
- Beakta alltid säkerhetsanvisningarna i bruksanvisningen som hör till respektive driftsystemet.
- När motorvagnens lokdel ska köras med konventionell/ analog drift måste anlutningsskenan vara avstörd. Till detta använder man anslutningsgarnityr 74046 med avstörning och överbelastningsskydd. Avstörningsskyddet får inte användas vid digital körning.
- **WARNING!** Funktionsbetingade vassa kanter och spetsar.
- Modellen får inte utsättas för direkt solljus, häftiga temperaturväxlingar eller hög luftfuktighet.

Viktig information

- Bruksanvisningen och förpackningen är en del av produkten och måste därför sparas och alltid medfölja produkten.
- Kontakta din Märklinfackhandlare för reparationer och reservdelar.
- Hantering som avfall: www.maerklin.com/en/imprint.html
- Garantivillkor framgår av bifogade garantibevis.

Funktioner

- Driftsättet igenkänns automatiskt.
- Inställbara adresser:
1-80 (Control Unit 6021/Mobile Station 60651/652)
1-255 (Central Station 6021x/Mobile Station 60653)
- Adress från tillverkaren: **50**
- Mfx-teknologi för Mobile Station/Central Station.
Namn från tillverkaren: **N 209 DSB**
- Accelerationsfördröjning kan ändras (ABV).
- Bromsfördröjning kan ändras (ABV).
- Toppfart kan ändras.
- Inställning av lokparametrar (Adress, acceleration/ bromsfördröjning, toppfart): Via Control Unit, Mobile Station eller Central Station.
- Körriktningsberoende frontbelysning.
- Vid analog körning är endast den automatiska ljusväxlingsfunktionen tillgänglig.
- Röksats kan monteras i efterhand - även för analogdrift.

Kopplingsbara funktioner					 Digital/Systems
Frontstrålkastare	function/off			Funktion f0	Funktion f0
Röksats 1)	f1	Funktion 1	Funktion 7	Funktion f1	Funktion f1
Ljud: Trafikljud	f2	Funktion 2	Funktion 3	Funktion f2	Funktion f2
Ljud: Lokvissla långt	f3	Funktion 3	Funktion 4	Funktion f3	Funktion f3
ABV från	f4	Funktion 4	Funktion 2	Funktion f4	Funktion f4
Ljud: Bromsgnissel från	—	—	Funktion 8	Funktion f5	Funktion f5
Ljud: Luftpump	—	—	Funktion 1	Funktion f6	Funktion f6
Ljud: Rangervissla kort	—	—	Funktion 5	Funktion f7	Funktion f7
Ljud: Ånga släpps ut	—	—	Funktion 6	Funktion f8	Funktion f8
Ljud: Lökklocka	—	—	—	Funktion f9	Funktion f9
Ljud: Kol skyfflas	—	—	—	Funktion f10	Funktion f10
Ljud: Roster skakas	—	—	—	Funktion f11	Funktion f11
Ljud: Injektor	—	—	—	Funktion f12	Funktion f12

1) Ingår inte i leveransen.

Vink om sikkerhed







- Lokomotivet må kun bruges med et driftssystem (Märklin AC, Märklin Delta, Märklin Digital eller Märklin Systems), der er beregnet dertil.
- Anvend kun DC-DC-omformere og transformatorer, der passer til den lokale netspænding.
- Lokomotivet må ikke forsynes fra mere end én strømkilde ad gangen.
- Vær under alle omstændigheder opmærksom på de vink om sikkerhed, som findes i brugsanvisningen for Deres driftssystem.
- Ved konventionel drift af lokomotivet skal tilslutningssporet støjdæmpes. Dertil skal anvendes støjdæmpningssættet 74046. Støjdæmpningssættet er ikke egnet til digital drift.
- **ADVARSEL!** Skarpe kanter og spidser pga. funktionen.
- Modellen må ikke udsættes for direkte sollys, store temperaturudsving eller høj luftfugtighed.

Vigtige bemærkninger

- Betjeningsvejledning og emballage hører til produktet og skal derfor gemmes og medfølge, hvis produktet gives videre til andre.
- For reparation eller reservedele bedes De henvende Dem til Deres Märklinforhandler.
- Bortskafning: www.maerklin.com/en/imprint.html
- Garanti ifølge vedlagte garantibevis.

Funktioner

- Registrering af driftsarten: automatisk.
- Indstillelige adresser:
1-80 (Control Unit 6021/Mobile Station 60651/652)
1-255 (Central Station 6021x/Mobile Station 60653)
- Adresse af fabrik: **50**
- Mfx-teknologi til Mobile Station/Central Station.
Navn af fabrik: **N 209 DSB**
- Indstillelig kørselsforsinkelse (ABV).
- Indstillelig bremseforsinkelse (ABV).
- Indstillelig maksimalhastighed.
- Indstilling af lokomotivparametrene (adresse, kørsels-/bremseforsinkelse, maksimalhastighed):
Via Control Unit, Mobile Station eller Central Station.
- Køreretningsafhængig frontbelysning.
- I analogdrift er det kun køre- og lysskiftefunktionerne, der er tilgængelige.
- Røggenerator kan eftermonteres – også til analogdrift.

Styrbare funktioner					 Digital/Systems
Frontbelysning	function/off			Funktion f0	Funktion f0
Røggenerator 1)	f1	Funktion 1	Funktion 7	Funktion f1	Funktion f1
Lyd: Driftslyd	f2	Funktion 2	Funktion 3	Funktion f2	Funktion f2
Lyd: Lokomotivfløjte langt	f3	Funktion 3	Funktion 4	Funktion f3	Funktion f3
ABV fra	f4	Funktion 4	Funktion 2	Funktion f4	Funktion f4
Lyd: Pibende bremses fra	—	—	Funktion 8	Funktion f5	Funktion f5
Lyd: Luftpumpe	—	—	Funktion 1	Funktion f6	Funktion f6
Lyd: Rangerfløjt kort	—	—	Funktion 5	Funktion f7	Funktion f7
Lyd: Dampudledning	—	—	Funktion 6	Funktion f8	Funktion f8
Lyd: Klokke	—	—	—	Funktion f9	Funktion f9
Lyd: Skovling af kul	—	—	—	Funktion f10	Funktion f10
Lyd: Rysterist	—	—	—	Funktion f11	Funktion f11
Lyd: Injektor	—	—	—	Funktion f12	Funktion f12

1) Medleveres ikke.

CV (Parameter) • CV (Parameter) • CV (Paramètre) • CV (Parameter) • CV (Parámetro) • CV (Parametro) • CV (Parameter) • CV (Parameter)	CV-Nr.	Wert • Value • Valeur • Waarde • Valor • Valore • Värde • Værdi
Adresse • Address • Adresse • Adres • Código • Indirizzo • Adress • Adresse	01	01 - (80)* 255
Anfahrverzögerung • Acceleration delay • Temporisation accélération • Optrekvertraging • Regulación arranque • Ritardo di avviamento • Igångsättningsreglering • Kørselsforsinkelse	03	01 - (63)* 255
Bremsverzögerung • Braking delay • Temporisation de freinage • Afremvertraging • Frenado lento • Ritardo di frenatura • Bromsfördröjning • Bremseforsinkelse	04	01 - (63)* 255
Höchstgeschwindigkeit • Maximum speed • Vitesse maximale • Maximumsneilheid • Velocidad máxima • Velocità massima • Toppfart • Maksimalhastighed	05	01 - (63)* 255
Rückstellen auf Serienwerte • Reset to series value • Remettre aux valeurs de série • Terugzetten naar serie-instellingen • Restablecer los valores de serie • Ripristinare sui valori di serie • Återställa till standardvärden • Tibagestil til serieværdien	08	08
Lautstärke • Volume • Volume haut-parleur • Volume • Volumen del sonido • Intensità del suono • Ljudstyrka • Lydstyrke	63	01 - (63)* 255

* () Control Unit 6021/Mobile Station 60651/60652

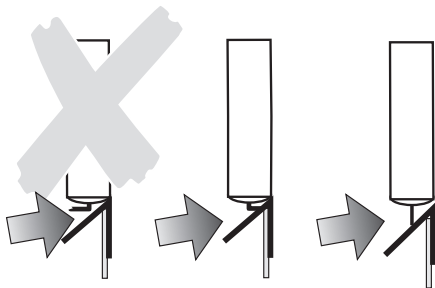
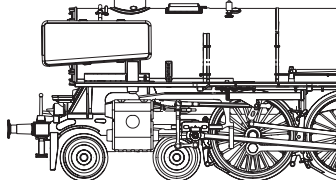
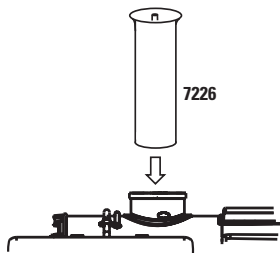

Potentielle Fehlerquellen beim Rauchgenerator

- Der Rauchgenerator darf nur maximal halb mit Rauchöl gefüllt sein.
- Im Rauchgenerator darf sich keine Luftblase befinden.
- Der Anschlussdraht an der Unterseite des Rauchgenerators muss sicheren Kontakt zur Anschlussfeder im Lokomotiv-Fahrgestell besitzen. Notfalls Anschlussdraht entsprechend nebenstehender Zeichnung justieren.

Potential Problems with the Smoke Generator

- The smoke generator cannot be filled any more than halfway with smoke fluid.
- There should not be any air bubbles in the smoke generator.
- The connecting wire on the underside of the smoke generator must have a clean contact with the connection field in the locomotive's frame. When necessary, adjust the connecting wire according to the diagram next to this text.

Causes d'erreurs potentielles avec le générateur fumigène

- Le générateur fumigène ne peut pas être rempli de liquide fumigène au-delà de la moitié du tube.
- Aucune bulle d'air ne peut se trouver dans le générateur fumigène.
- Le câble de raccordement raccordé à la face inférieure du fumigène doit posséder un contact sûr avec le ressort de connexion dans le châssis de la locomotive. En cas de besoin, ajustez le câble de connexion en vous conformant au schéma.

Potentiële storingsoorzaken bij rookgeneratoren

- De rookgenerator mag maximaal half met rookolie gevuld worden.
- In de rookgenerator mag zich geen luchtbel bevinden.
- De aansluitdraad aan de onderzijde van de rookgenerator moet een betrouwbaar contact maken met de contactveer in het locomotief onderstel. Eventueel de aansluitdraad volgens de onderstaande tekening bijstellen.

Instrucciones importantes para el buen uso del fumígeno

- Llenar el cartucho solamente hasta la mitad con líquido fumígeno.
- Prestar atención que no se forme una burbuja de aire en el cartucho.
- El hilo tomacorriente de la base debe tener un buen contacto con el resorte que está en el bastidor de la locomotora. Si fuera necesario, ajustar el hilo tomacorriente según la ilustración. In caso di necessità, si regoli il conduttore di alimentazione in modo corrispondente al disegno che si trova qui accanto.

Potenziali origini di guasti nel caso dell'apparato fumogeno

- L'apparato fumogeno come massimo deve essere riempito solamente a metà di olio vaporizzabile.
- Nell'apparato fumogeno non deve trovarsi alcuna bolla d'aria.
- Il conduttore di alimentazione sulla faccia inferiore dell'apparato fumogeno deve possedere un sicuro contatto verso la molla di connessione nel telaio della locomotiva. In caso di necessità, si regoli il conduttore di alimentazione in modo corrispondente al disegno che si trova qui accanto.

Potentiella felkällor på rökgeneratoren

- Rökgeneratoren får maximalt fyllas till hälften med rökvätska.
- I rökgeneratoren får inte finnas någon luftblåsa.
- Anslutningstråden på rökgeneratorns undersida måste ha en säker kontakt med anslutningsfjäders i lokets chassi. I nödfall måste anslutningstråden justeras enligt teckningen bredvid. I nödfall måste anslutningstråden justeras enligt teckningen bredvid.

Potentielle fejkilder ved røggeneratoren

- Røggeneratoren må maksimalt være halvt fyldt med røgolie.
- Der må ikke være nogen luftbobler i røggeneratoren.
- Der skal være en god og sikker kontakt mellem tilslutningstråden på undersiden af røggeneratoren og tilslutningsfjederen i lokomotivets understel. I nødstilfælde skal tilslutningstråden justeres ifølge tegningen her ved siden af.

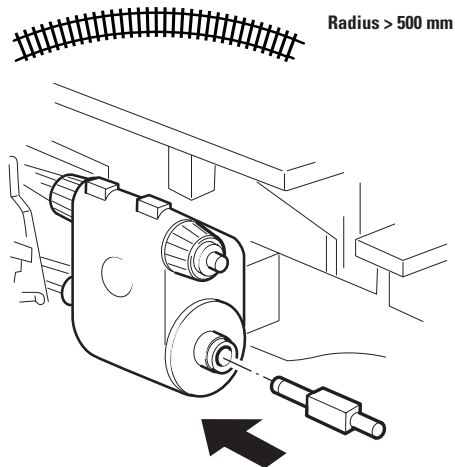

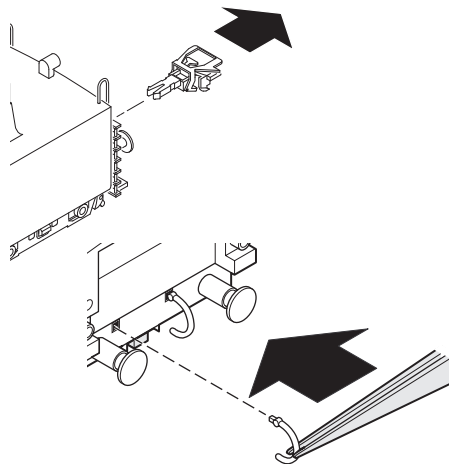
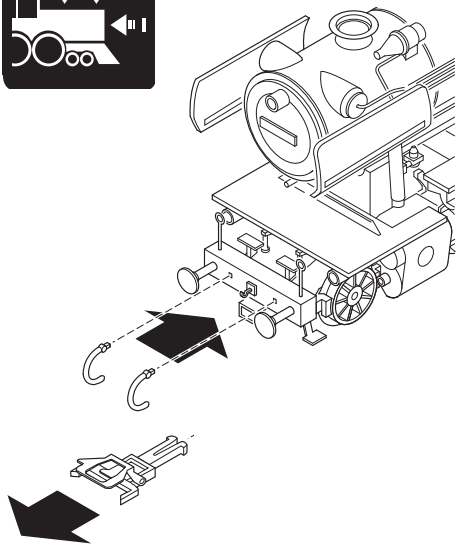

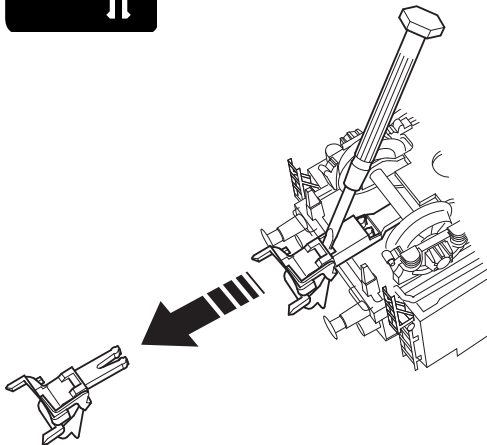
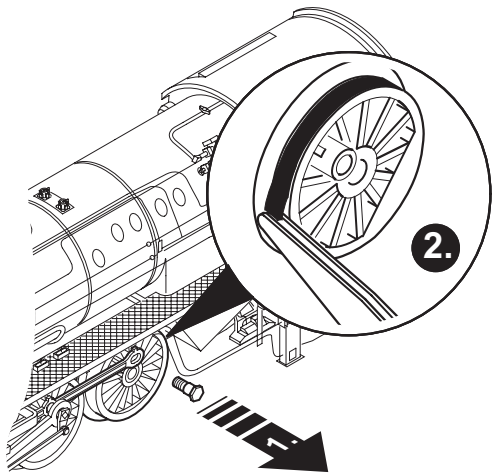
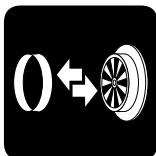

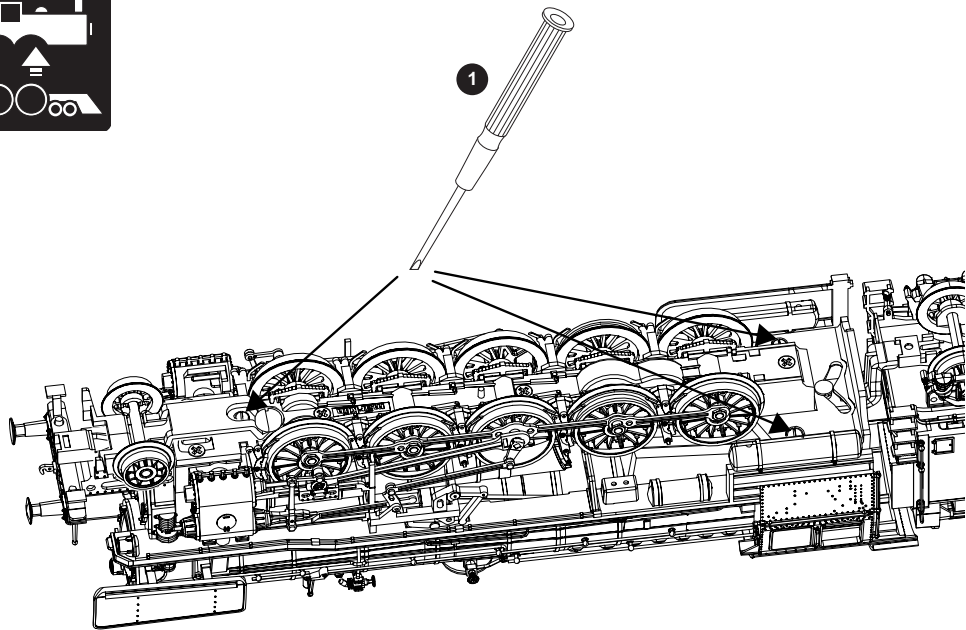



2

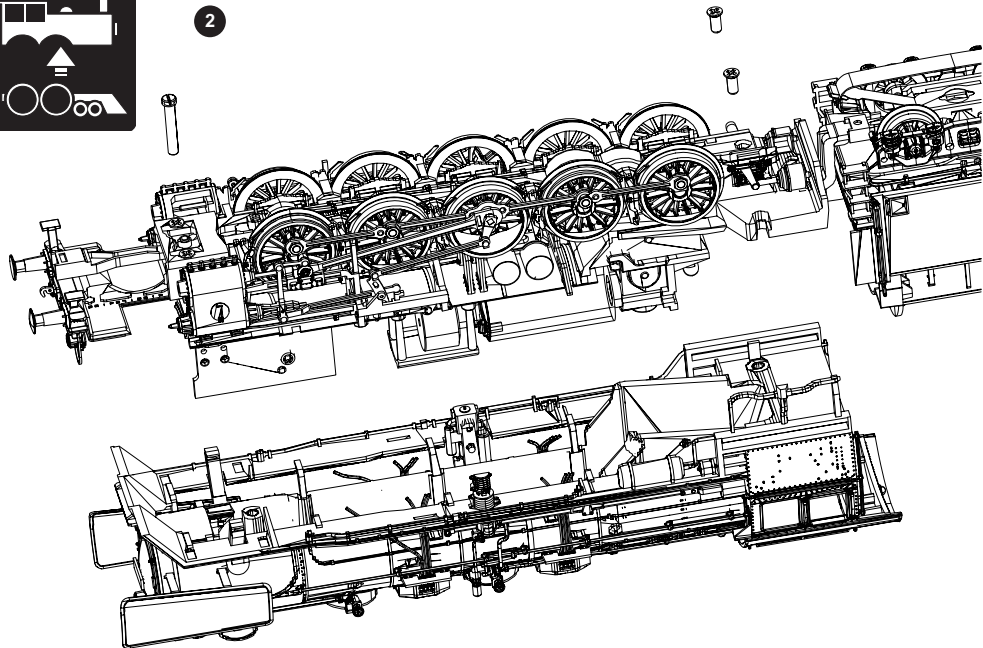

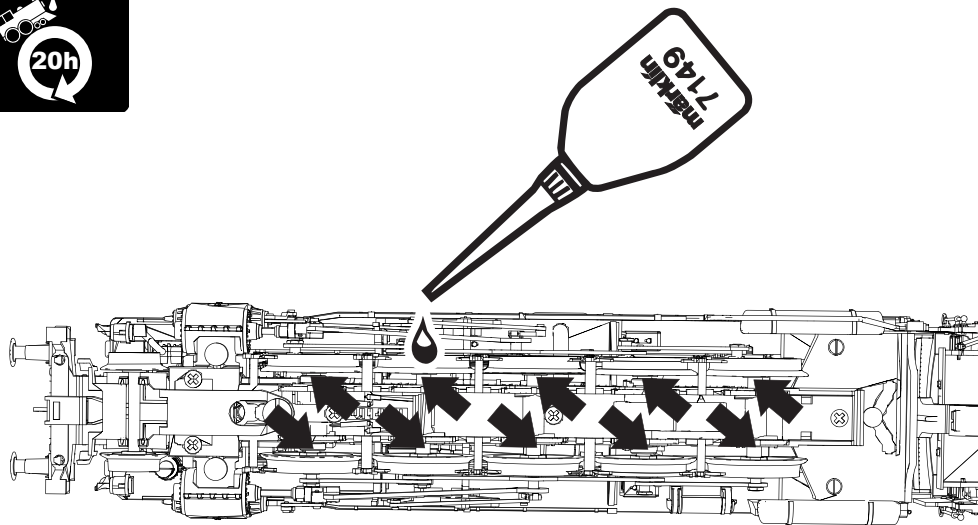



Trix 66626

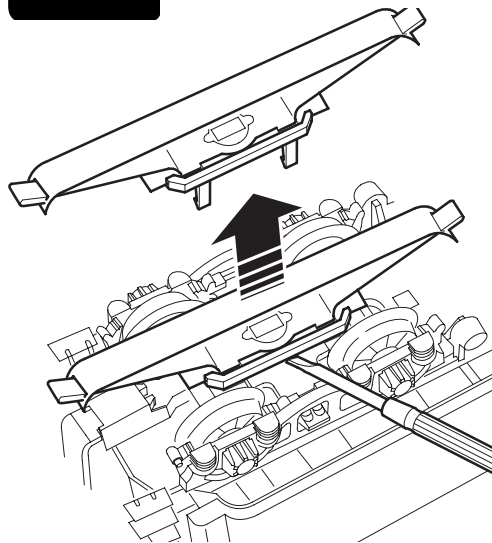
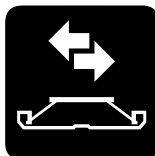
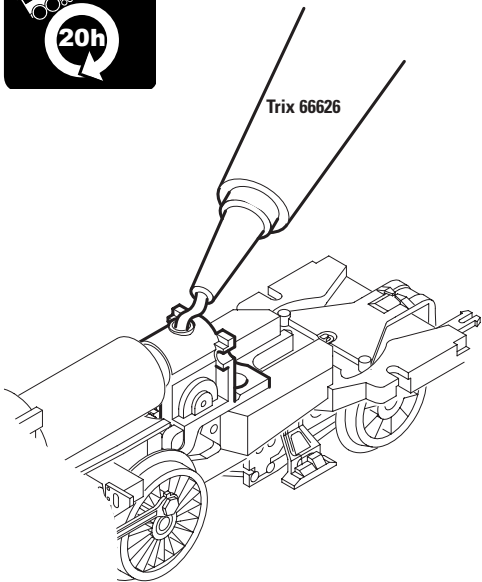

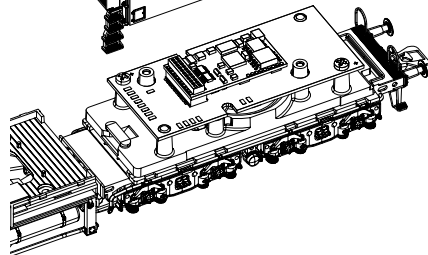
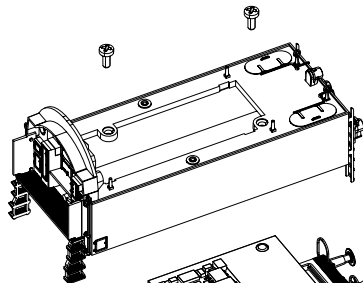
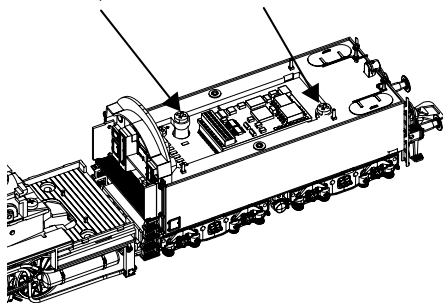
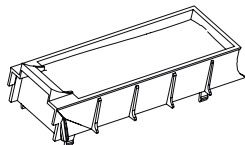
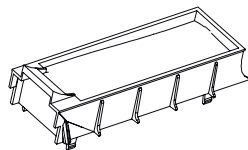

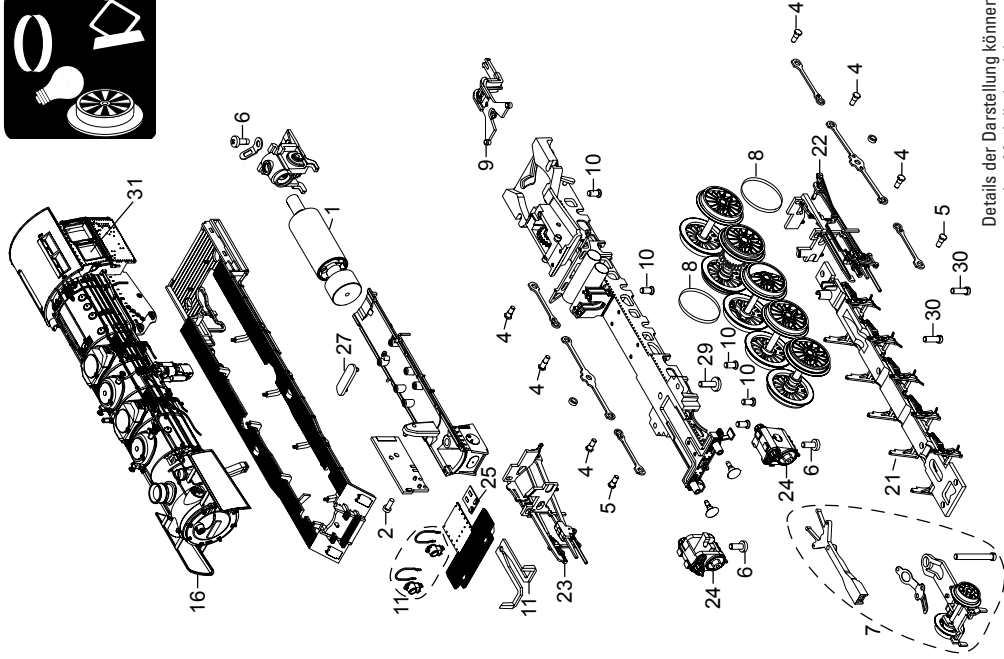

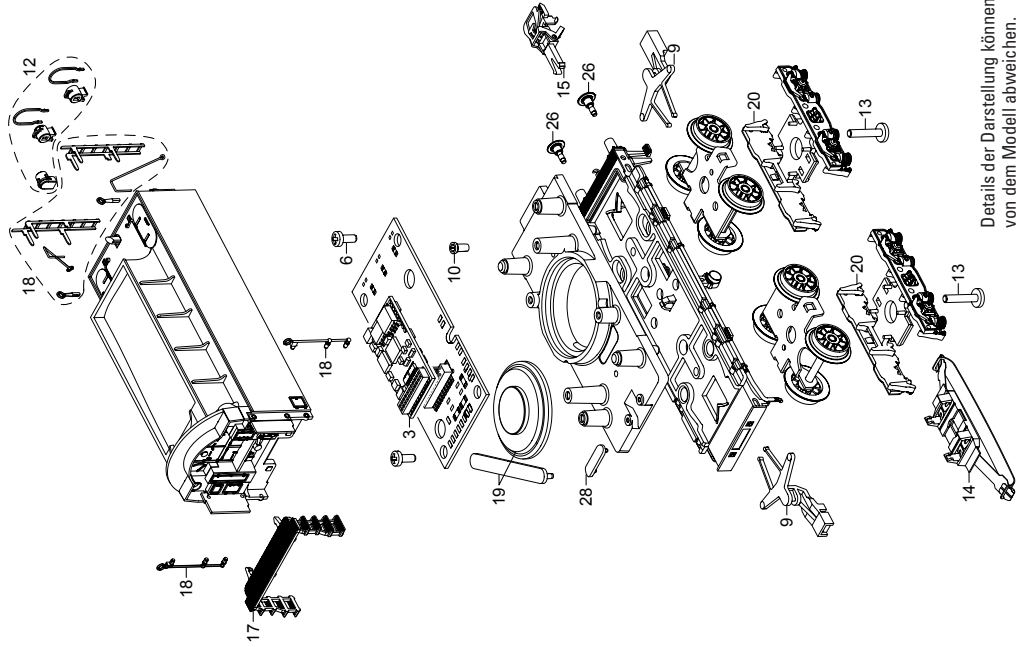

Details der Darstellung können von dem Modell abweichen.

1 Motor	E232 053	21 Bremsattrappe	E175 836
2 Schraube	E786 341	22 Gestänge, links	E175 843
3 Decoder	241 193	23 Gestänge, rechts	E175 840
4 Schraube	E499 840	24 Zylinder	E180 624
5 Schraube	E223 431	25 Leiterplatte Beleuchtung	E241 194
6 Schraube	E786 750	26 Puffer rund	E144 353
7 Vorlaufgestell	E243 815	Puffer flach	E123 252
8 Haftreifen	7 153	27 Abdeckung	E190 067
9 Deichsel, Zugstange	E177 979	28 Haltebügel	E209 442
10 Schraube	E786 790	29 Schraube	E785 200
11 Laterne	E243 816	30 Schraube	E19 7086 28
12 Laternen	E243 817	31 Fenster	E162 174
13 Schraube	E750 230	Pumpen, Pfeife, Glocke	E243 823
14 Schleifer	E138 079	Bremsleitung	E12 5149 00
15 Kupplung	E701 630	Kolbenstangenschutzrohr	E213 450
16 Windleitbleche	E188 580	Schneepflug, Leiter	E243 835
17 Tenderbühne	E242 642		
18 Leitern, Stangen	E180 621		
19 Lautsprecher	E180 622		
20 Drehgestellblenden	E188 595		

Hinweis: Einige Teile werden nur ohne oder mit anderer Farbgebung angeboten.

Teile, die hier nicht aufgeführt sind, können nur im Rahmen einer Reparatur im Märklin-Reparatur-Service repariert werden.

Due to different legal requirements regarding electro-magnetic compatibility, this item may be used in the USA only after separate certification for FCC compliance and an adjustment if necessary.

Use in the USA without this certification is not permitted and absolves us of any liability. If you should want such certification to be done, please contact us – also due to the additional costs incurred for this.

Gebr. Märklin & Cie. GmbH
Stuttgarter Straße 55 - 57
73033 Göppingen
Germany
www.maerklin.com



www.maerklin.com/en/imprint.html

243235/1114/Ha1Ef
Änderungen vorbehalten
© Gebr. Märklin & Cie. GmbH