



Modell der Serie Re 6/6
37324

Inhaltsverzeichnis:	Seite
Informationen zum Vorbild	4
Sicherheitshinweise	6
Allgemeine Hinweise	6
Funktionen	6
Schaltbare Funktionen	7
Parameter / Register	23
Ergänzendes Zubehör	24
Wartung und Instandhaltung	25
Ersatzteile	34

Sommaire :	Page
Informations concernant la locomotive réelle	5
Remarques importantes sur la sécurité	10
Informations générales	10
Fonction	10
Fonctions commutables	11
Paramètre / Registre	23
Accessoires complémentaires	24
Entretien et maintien	25
Pièces de rechange	34

Table of Contents:	Page
Information about the prototype	4
Safety Notes	8
General Notes	8
Function	8
Controllable Functions	9
Parameter / Register	23
Complementary accessories	24
Service and maintenance	25
Spare Parts	34

Inhoudsopgave:	Pagina
Informatie van het voorbeeld	5
Veiligheidsvoorschriften	12
Algemene informatie	12
Functies	12
Schakelbare functies	13
Parameter / Register	23
Aanvullende toebehoren	24
Onderhoud en handhaving	25
Onderdelen	34

Indice de contenido:	Página	Innehållsförteckning:	Sida
Aviso de seguridad	14	Säkerhetsanvisningar	18
Informaciones generales	14	Allmänna informationer	18
Funciones	14	Funktioner	18
Funciones posibles	15	Kopplingsbara funktioner	19
Parámetro / Registro	23	Parameter / Register	23
Accesorios complementarios	24	Ytterligare tillbehör	24
El mantenimiento	25	Underhåll och reparation	25
Recambios	34	Reservdelar	34

Indice del contenido:	Page	Indholdsfortegnelse:	Side
Avvertenze per la sicurezza	16	Vink om sikkerhed	20
Avvertenze generali	16	Generelle oplysninger	20
Funzioni	16	Funktioner	20
Funzioni commutabili	17	Styrbare funktioner	21
Parametro / Registro	23	Parameter / Register	23
Accessori complementari	24	Ekstra tilbehør	24
Manutenzione ed assistere	25	Service og reparation	25
Pezzi di ricambio	34	Reserve dele	34

Re 6/6 – 3 Drehgestelle am Gotthard.

Anfang der 1970er-Jahre zeichnete sich das Ende der legendären Serie Ae 6/6 auf der Gotthardstrecke ab. Die Schweizerischen Bundesbahnen SBB ließen daher von den Firmen SLM Winterthur, BBC Baden und SAAS Genève eine Nachfolgebauereihe entwickeln: die Serie Re 6/6.

Die schweren Bedingungen am Gotthard verlangten eine Lokomotive mit 6 Treibachsen. Um den Verschleiß gering zu halten, entschieden sich die verantwortlichen Konstrukteure nicht wie bei der Ae 6/6 für zwei, sondern für drei Drehgestelle, wobei das mittlere eine starke Seitenverschieblichkeit aufweist. Die Drehgestelle untereinander sind mit elastischen Querkupplungen verbunden, um einen optimalen Kurvenlauf zu gewährleisten. Die Führerstände der Re 6/6 lehnen sich stark an das Design der Re 4/4 II an, ebenso die elektrische Ausrüstung der Transformatoren, von denen die Re 6/6 allerdings zwei besitzt. Die 19.310 mm langen, 120 t schweren und 140 km/h schnellen Lokomotiven haben eine Leistung von 7850 kW.

Die Re 6/6 haben sich mehreren Lackierungsvarianten und Erneuerungen unterziehen müssen, 30 Lokomotiven wurden ab dem Jahr 2000 mit Funkfernsteuerung ausgerüstet, diese Maschinen laufen unter der Bezeichnung Ref 6/6. Die UIC Bezeichnung der Serie Re 6/6 ist die Serie 620, die immer öfter auf den Maschinen auch zu sehen ist. Die 88 noch im Dienst stehenden Lokomotiven gehören alle zum Geschäftsbereich SBB Cargo und kommen mit schweren Güterzügen in alle Ecken der Schweiz, über den Gotthard auch mit einer Re 4/4 II oder Re 4/4 III im Tandemverkehr. Im schweren Personenverkehr waren die Loks der Serie Re 6/6 sogar eine Alternative zu einer Re 4/4 II Doppeltraktion und nachdem die moderne Serie 460 hauptsächlich dem Personenverkehr zugeordnet wurde, dominieren die beeindruckenden Re 6/6 mit ihren drei Drehgestellen wieder den Güterverkehr am Gotthard.

The Re 6/6 – 3 Trucks on the Gotthard.

The beginning of the Seventies marked the end of the legendary class Ae 6/6 on the Gotthard route. The Swiss Federal Railways (SBB) therefore had the firms SLM Winterthur, BBC Baden, and SAAS Genève develop a successor design: the class Re 6/6.

The difficult conditions on the Gotthard required a locomotive with 6 powered axles. In order to keep wear to a minimum, the designers for the project decided against two trucks such as for the Ae 6/6. Instead, they went with three trucks, with the middle one having a great deal of side play. The trucks are linked with each other with elastic transverse couplings to guarantee optimum operation on curves. The engineer's cabs on the Re 6/6 borrowed heavily from the design for the Re 4/4 II as did the electrical equipment for the transformers, of which the Re 6/6 has two. These locomotives are 19,310 mm / 63 feet 4-3/16 inches long, weigh 120 metric tons, and have a maximum speed of 140 km/h / 87 mph; their performance is 7,850 kilowatts / 10,527 horsepower.

The Re 6/6 locomotives have had to undergo several paint variations and overhauls. Thirty locomotives were equipped with remote radio control starting in 2000; these units are used with the designation Ref 6/6. The UIC designation for the class Re 6/6 is the class 620, which can be seen with increasing frequency on the locomotives. The 88 units still in service all belong to the SBB Cargo business area and haul heavy freight trains to all corners of Switzerland, also over the Gotthard route with a Re 4/4 II or Re 4/4 III in tandem motive power consists. The class Re 6/6 locomotives were even an alternative to a Re 4/4 II double motive power combination in heavy passenger service. After the modern class 460 was mainly assigned to passenger service, the impressive Re 6/6 with its three trucks once again dominates freight service on the Gotthard.

Re 6/6 – 3 bogies sur la ligne du Saint Gothard.

Au début des années 1970 se profilait la fin de la légendaire série Ae 6/6 sur la ligne du Saint Gothard. Les chemins de fer fédéraux suisses CFF (SBB) demandèrent donc la conception d'une série de relève aux firmes SLM Winterthur, BBC Baden et SAAS Genève : la série Re 6/6.

Les conditions difficiles sur la ligne du Saint Gothard nécessitaient une locomotive équipée de 6 essieux moteurs. Afin de réduire l'usure par frottement, les constructeurs responsables se décidèrent non pour deux bogies (comme pour la Ae 6/6), mais pour trois, celui du milieu présentant un désaxement latéral important. Les bogies sont reliés entre eux par des accouplements transversaux élastiques garantissant une inscription en courbe optimale. Les cabines de conduite de la Re 6/6 s'inspirent fortement du design de la Re 4/4 II, tout comme l'équipement électrique des transformateurs, dont la Re 6/6 possède toutefois deux unités. Les locomotives, mesurant 19 310 mm, pesant 120 t et atteignant une vitesse de 140 km/h affichent une puissance de 7850 kW.

Les Re 6/6 passèrent par différentes livrées et rénovations ; à partir de l'an 2000, 30 locomotives – circulant sous la désignation Ref 6/6 - furent équipées d'une radio-télécommande. La désignation UIC de la série Re 6/6 est la série 620, apparaissant d'ailleurs de plus en plus souvent sur les machines. Les 88 locomotives encore en service appartiennent toutes au département CFF Cargo et remorquent des trains marchandises lourds dans toutes les régions de la Suisse et, sur la ligne du Saint Gothard, éventuellement en traction double avec une Re 4/4 II ou une Re 4/4 III. Dans le trafic voyageurs lourd, les locomotives de la série Re 6/6 pouvaient même remplacer une double traction de Re 4/4 II et après l'affectation de la moderne série 460 au trafic voyageurs, les impressionnantes Re 6/6 avec leurs trois bogies dominèrent à nouveau le trafic marchandises sur la ligne du Saint Gothard.

Re 6/6 – 3 draaistellen op de Gotthard.

Begin jaren 1970 tekende het einde van de legendarische serie Ae 6/6 op de Gotthardlijn zich af. De Schweizerische Bundesbahnen SBB lieten daarom door de firma's SLM Winterthur, BBC Baden en SAAS Genève een serie opvolgers ontwikkelen: de serie Re 6/6.

De zware omstandigheden op de Gotthard verlangden een locomotief met 6 aangedreven assen. Om de slijtage laag te houden, besloten de verantwoordelijke constructeurs niet zoals bij de Ae 6/6 tot twee, maar tot drie draaistellen, waarbij het middelste een sterke zijdelingse verschuiving toont. De draaistellen zijn onderling met elastische dwarskoppelingen verbonden, om een optimale loop door bogen te garanderen. De cabines van de Re 6/6 leunen sterk op het design van de Re 4/4 II, evenals de elektrische uitrusting van de transformatoren, waarvan de Re 6/6 er echter twee bezit. De 19.310 mm lange, 120 t zware en 140 km/h snelle locomotieven hebben een vermogen van 7850 kW.

De Re 6/6 hebben zich meerdere kleurvarianten en vernieuwingen moeten laten weggevallen, 30 locomotieven werden vanaf het jaar 2000 met radio-afstandsregeling uitgerust, deze machines lopen onder de aanduiding Ref 6/6. De UIC-aanduiding van de serie Re 6/6 is de serie 620, die steeds vaker op de machines ook te zien is. De 88 nog in dienst staande locomotieven behoren alle tot de sector SBB Cargo en komen met zware goederentreinen in alle uithoeken van Zwitserland, over de Gotthard ook met een Re 4/4 II of Re 4/4 III in tandemverkeer. In het zware personenverkeer waren de locs van de serie Re 6/6 zelfs een alternatief voor een Re 4/4 II dubbeltractie en nadat de moderne serie 460 hoofdzakelijk aan het personenverkeer toegewezen werd, domineren de indrukwekkende Re 6/6en met hun drie draaistellen weer het goederenverkeer op de Gotthard.

Sicherheitshinweise









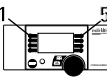

- Die Lok darf nur mit einem dafür bestimmten Betriebssystem (Märklin Wechselstrom, Märklin Delta, Märklin Digital oder Märklin Systems) eingesetzt werden.
- Nur Schaltnetzteile/Transformatoren verwenden, die Ihrer örtlichen Netzspannung entsprechen.
- Die Lok darf nur aus einer Leistungsquelle versorgt werden.
- Beachten Sie unbedingt die Sicherheitshinweise in der Bedienungsanleitung zu Ihrem Betriebssystem.
- Für den konventionellen Betrieb der Lok muss das Anschlussgleis entstört werden. Dazu ist das Entstörset 74046 zu verwenden. Für Digitalbetrieb ist das Entstörset nicht geeignet.
- **ACHTUNG!** Funktionsbedingte scharfe Kanten und Spitzen.
- Setzen Sie das Modell keiner direkten Sonneneinstrahlung, starken Temperaturschwankungen oder hoher Luftfeuchtigkeit aus.

Allgemeine Hinweise

- Die Bedienungsanleitung und die Verpackung sind Bestandteil des Produktes und müssen deshalb aufbewahrt sowie bei Weitergabe des Produktes mitgegeben werden.
- Für Reparaturen oder Ersatzteile wenden Sie sich bitte an Ihren Märklin-Fachhändler.
- Gewährleistung und Garantie gemäß der beiliegenden Garantieurkunde.
- <http://www.maerklin.com/en/imprint.html>

Funktionen

- Erkennung der Betriebsart: automatisch.
- Einstellbare Adressen:
1-80 (Control Unit 6021/Mobile Station 60651/652)
1-255 (Central Station 6021x/Mobile Station 60653)
- Adresse ab Werk: **62**
- Mfx-Technologie für Mobile Station / Central Station.
Name ab Werk: **RE 6/6 11675**
- Veränderbare Anfahrverzögerung (ABV).
- Veränderbare Bremsverzögerung (ABV).
- Veränderbare Höchstgeschwindigkeit.
- Einstellen der Lokparameter (Adresse, Anfahr-/Bremsverzögerung, Höchstgeschwindigkeit): über Control Unit, Mobile Station oder Central Station.
- Fahrtrichtungsabhängige Stirnbeleuchtung.
- Im Analogbetrieb stehen nur die Fahr- und Lichtwechselfunktionen zur Verfügung.

Schaltbare Funktionen					 Digital / Systems
Stirnbeleuchtung	function/off			Funktion f0	Funktion f0
Fernlicht	f1	Funktion 1	Funktion 3	Funktion f1	Funktion f1
Geräusch: Betriebsgeräusch	f2	Funktion 2	Funktion 6	Funktion f2	Funktion f2
Geräusch: Lokpfeife	f3	Funktion 3	Funktion 4	Funktion f3	Funktion f3
ABV	f4	Funktion 4	Funktion 2	Funktion f4	Funktion f4
Geräusch: Bremsenquietschen ein/aus	—	—	Funktion 7	Funktion f5	Funktion f5
Stirnbeleuchtung Führerstand 2 aus/an	—	—	 + 1	f0 + f6	f0 + f6
Geräusch: Lokpiff kurz	—	—	Funktion 5	Funktion f7	Funktion f7
Stirnbeleuchtung Führerstand 1 aus/an	—	—	 + 8	f0 + f8	f0 + f8
Geräusch: Hauptschalter	—	—	—	Funktion f9	Funktion f9
Geräusch: Kompressor	—	—	—	Funktion f10	Funktion f10
Rangierlicht doppel A	—	—	 + 1 + 8	f0 + f6 + f8	f0 + f6 + f8

Safety Notes









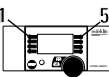

- This locomotive is to be used only with an operating system designed for it (Märklin AC, Märklin Delta, Märklin Digital or Märklin Systems).
- Use only switched mode power supply units and transformers that are designed for your local power system.
- This locomotive must never be supplied with power from more than one transformer.
- Pay close attention to the safety notes in the instructions for your operating system.
- The feeder track must be equipped to prevent interference with radio and television reception, when the locomotive is to be run in conventional operation. The 74046 interference suppression set is to be used for this purpose.
- **WARNING!** Sharp edges and points required for operation.
- Do not expose the model to direct sunlight, extreme changes in temperature, or high humidity.

General Notes

- The operating instructions and the packaging are a component part of the product and must therefore be kept as well as transferred along with the product to others.
- Please see your authorized Märklin dealer for repairs or spare parts.
- The warranty card included with this product specifies the warranty conditions.
- <http://www.maerklin.com/en/imprint.html>

Functions

- Recognition of the mode of operation: automatic.
- Addresses that can be set:
1-80 (Control Unit 6021/Mobile Station 60651/652)
1-255 (Central Station 6021x/Mobile Station 60653)
- Address set at the factory: **62**
- Mfx technology for the Mobile Station / Central Station.
Name set at the factory: **RE 6/6 11675**
- Adjustable acceleration (ABV).
- Adjustable Braking delay (ABV).
- Adjustable maximum speed.
- Setting the locomotive parameters (address, acceleration/braking delay, maximum speed): with the Control Unit, Mobile Station, Central Station.
- Headlights, changing over with the direction of travel.
- Only the train control functions and headlight changeover feature are available in analog operation.

Controllable Functions					 Digital / Systems
Headlights	function/off			Function f0	Function f0
Long distance headlights	f1	Function 1	Function 3	Function f1	Function f1
Sound effect: Operating sounds	f2	Function 2	Function 6	Function f2	Function f2
Sound effect: Locomotive whistle	f3	Function 3	Function 4	Function f3	Function f3
ABV	f4	Function 4	Function 2	Function f4	Function f4
Sound effect: Squealing brakes off	—	—	Function 7	Function f5	Function f5
Headlights at engineer´s cab 2 off/on	—	—	 + 1	f0 + f6	f0 + f6
Sound effect: Short whistle blast	—	—	Function 5	Function f7	Function f7
Headlights at engineer´s cab 1 off/on	—	—	 + 8	f0 + f8	f0 + f8
Sound effect: Main relay	—	—	—	Function f9	Function f9
Sound effect: compressor	—	—	—	Function f10	Function f10
Double A switching light	—	—	 + 1 + 8	f0 + f6 + f8	f0 + f6 + f8

Remarques importantes sur la sécurité









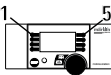

- La locomotive ne peut être mise en service qu'avec un système d'exploitation adéquat (Märklin AC, Märklin Delta, Märklin Digital ou Märklin Systems).
- Utiliser uniquement des convertisseurs et transformateurs correspondant à la tension du secteur local.
- La locomotive ne peut être alimentée en courant que par une seule source de courant.
- Veuillez impérativement respecter les remarques sur la sécurité décrites dans le mode d'emploi de votre système d'exploitation.
- Pour l'exploitation de la locomotive en mode conventionnel, la voie de raccordement doit être déparasitée. A cet effet, utiliser le set de déparasitage réf. 74046. Le set de déparasitage ne convient pas pour l'exploitation en mode numérique.
- **ATTENTION!** Pointes et bords coupants lors du fonctionnement du produit.
- Ne pas exposer le modèle à un ensoleillement direct, à de fortes variations de température ou à un taux d'humidité important.

Informations générales

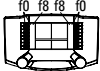
- La notice d'utilisation et l'emballage font partie intégrante du produit ; ils doivent donc être conservés et, le cas échéant, transmis avec le produit.
- Pour toute réparation ou remplacement de pièces, adressez-vous à votre détaillant-spécialiste Märklin.
- Garantie légale et garantie contractuelle conformément au certificat de garantie ci-joint.
- <http://www.maerklin.com/en/imprint.html>

Fonctionnement

- Détection du mode d'exploitation : automatique.
- Adresses disponibles :
1-80 (Control Unit 6021/Mobile Station 60651/652)
1-255 (Central Station 6021x/Mobile Station 60653)
- Adresse encodée en usine : **62**
- Technologie mfx pour Mobile Station / Central Station.
Nom encodée en usine : **RE 6/6 11675**
- Temporisation d'accélération réglable (ABV).
- Temporisation de freinage réglable (ABV).
- Vitesse maximale réglable.
- Réglage des paramètres de la loco (adresse, temporisation accélér.-freinage, vitesse maximale) : via Control Unit, Mobile Station ou Central Station.
- Feux de signalisation avec inversion selon sens de marche.
- En mode d'exploitation analogique, seules les fonctions relatives à la conduite et à l'inversion des feux sont disponibles.

Fonctions commutables					 Digital / Systems
Fanal	function/off			Fonction f0	Fonction f0
Phares à longue portée	f1	Fonction 1	Fonction 3	Fonction f1	Fonction f1
Bruitage : Bruit d'exploitation	f2	Fonction 2	Fonction 6	Fonction f2	Fonction f2
Bruitage : Sifflet locomotive	f3	Fonction 3	Fonction 4	Fonction f3	Fonction f3
ABV	f4	Fonction 4	Fonction 2	Fonction f4	Fonction f4
Bruitage : Grincement de freins désactivé	—	—	Fonction 7	Fonction f5	Fonction f5
Fanal de la cabine de conduite 2 éteint/activé	—	—	 + 1	f0 + f6	f0 + f6
Bruitage : sifflet court	—	—	Fonction 5	Fonction f7	Fonction f7
Fanal de la cabine de conduite 1 éteint/activé	—	—	 + 8	f0 + f8	f0 + f8
Bruitage : combinateur de commande	—	—	—	Fonction f9	Fonction f9
Bruitage : Compresseur	—	—	—	Fonction f10	Fonction f10
Feu de manoeuvre double A	—	—	 + 1 + 8	f0 + f6 + f8	f0 + f6 + f8

Veiligheidsvoorschriften









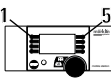

- De loc mag alleen met een daarvoor bestemd bedrijfssysteem (Märklin AC, Märklin Delta, Märklin digitaal of Märklin Systems) gebruikt worden.
- Alleen net-adapters en transformatoren gebruiken waarvan de aangegeven netspanning overeenkomt met de netspanning ter plaatse.
- De loc mag niet vanuit meer dan één stroomvoorziening gelijktijdig gevoed worden.
- Lees ook aandachtig de veiligheidsvoorschriften in de gebruiksaanwijzing van uw bedrijfssysteem.
- Voor het conventionele bedrijf met de loc dient de aansluitrail te worden ontstoort. Hiervoor dient men de ontstoor-set 74046 te gebruiken. Voor het digitale bedrijf is deze ontstoor-set niet geschikt.
- **OPGEPAST!** Functionele scherpe kanten en punten.
- Stel het model niet bloot aan in directe zonnestraling, sterke temperatuurwisselingen of hoge luchtvochtigheid.

Algemene informatie

- De gebruiksaanwijzing en de verpakking zijn een bestanddeel van het product en dienen derhalve bewaard en meegeleverd te worden bij het doorgeven van het product.
- Voor reparatie of onderdelen kunt u zich tot uw Märklin handelaar wenden.
- Vrijwaring en garantie overeenkomstig het bijgevoegde garantiebewijs.
- <http://www.maerklin.com/en/imprint.html>

Funcities

- Herkenning van het bedrijfssysteem: automatisch.
- Instelbare adressen:
1-80 (Control Unit 6021/Mobile Station 60651/652)
1-255 (Central Station 6021x/Mobile Station 60653)
- Vanaf de fabriek ingesteld: **62**
- Mfx-technologie voor het Mobile Station/Central Station. Naam af de fabriek: **RE 6/6 11675**
- Instelbare optrekvertraging (ABV).
- Instelbare afremvertraging (ABV).
- Instelbare maximumsnelheid.
- Instellen van de locomotiefparameters (adres, optrek-/afremvertraging, maximumsnelheid): d.m.v. Control Unit, Mobile Station of Central Station.
- Rijrichtingafhankelijke frontseinen.
- In analoogbedrijf zijn alleen de rij- en lichtwissel-functies beschikbaar.

Schakelbare functies					 Digital / Systems
Frontverlichting	function/off			Functie f0	Functie f0
Schijnwerper	f1	Functie 1	Functie 3	Functie f1	Functie f1
Geluid: bedrijfsgeluiden	f2	Functie 2	Functie 6	Functie f2	Functie f2
Geluid: locfluit	f3	Functie 3	Functie 4	Functie f3	Functie f3
ABV	f4	Functie 4	Functie 2	Functie f4	Functie f4
Geluid: piepende remmen uit	—	—	Functie 7	Functie f5	Functie f5
Frontverlichting Cabine 2 uit/aan	—	—	 + 1	f0 + f6	f0 + f6
Geluid: fluit kort	—	—	Functie 5	Functie f7	Functie f7
Frontverlichting Cabine 1 uit/aan	—	—	 + 8	f0 + f8	f0 + f8
Geluid van de hoofdschakelaar	—	—	—	Functie f9	Functie f9
Geluid: compressor	—	—	—	Functie f10	Functie f10
Rangeerlicht dubbel A	—	—	 + 1 + 8	f0 + f6 + f8	f0 + f6 + f8

Aviso de seguridad

- La locomotora solamente debe funcionar en un sistema de corriente propio (Märklin AC – Märklin Delta – Märklin Digital o Märklin Systems).
- Emplear únicamente fuentes de alimentación conmutadas y transformadores que sean de la tensión de red local.
- La locomotora no deberá recibir corriente eléctrica mas que de un solo punto de abasto.
- Observe bajo todos los conceptos, las medidas de seguridad indicadas en las instrucciones de su sistema de funcionamiento.
- Para el funcionamiento convencional de la locomotora deben suprimirse las interferencias en la vía de conexión de la alimentación. Para ello debe emplearse el set supresor de interferencias 74046. El set supresor de interferencias no es adecuado para el funcionamiento en modo digital.
- ¡**ATENCIÓN!** Esquinas y puntas afiladas condicionadas a la función.
- No exponer el modelo en miniatura a la radiación solar directa, a oscilaciones fuertes de temperatura o a una humedad del aire elevada.

Informaciones generales









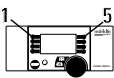

- Las instrucciones de empleo y el embalaje forman parte íntegra del producto y, por este motivo, deben guardarse y entregarse junto con el producto en el caso de venderlo o transmitirlo a otro.
- Para reparaciones o recambios contacte con su proveedor Märklin especializado.
- Responsabilidad y garantía conforme al documento de

garantía que se adjunta.

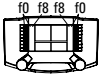
- <http://www.maerklin.com/en/imprint.html>

Funciones

- Reconocimiento del sistema: automático.
- Códigos disponibles:
1-80 (Control Unit 6021/Mobile Station 60651/652)
1-255 (Central Station 6021x/Mobile Station 60653)
- Código de fábrica: **62**
- Tecnología mfx para la Mobile Station/Central Station.
Nombre de fábrica: **RE 6/6 11675**
- Arranque lento variable (ABV).
- Frenado lento variable (ABV).
- Velocidad máxima variable.
- Fijar parámetros de la locomotora (código, arranque y frenado, velocidad máxima): por el Control Unit, Mobile Station o Central Station.
- Faros frontales dependientes del sentido de marcha.
- En funcionamiento en modo analógico están disponibles únicamente las funciones de tracción y de alternancia de luces.

Funciones posibles					 Digital / Systems
Faros frontales	function/off			Función f0	Función f0
Faros de largo alcance	f1	Función 1	Función 3	Función f1	Función f1
Ruido: ruido de explotación	f2	Función 2	Función 6	Función f2	Función f2
Ruido del silbido de la locomotora	f3	Función 3	Función 4	Función f3	Función f3
ABV	f4	Función 4	Función 2	Función f4	Función f4
Ruido: desconectar chirrido de los frenos	—	—	Función 7	Función f5	Función f5
Faros frontales a la cabina 2	—	—	 + 1	f0 + f6	f0 + f6
Ruido del silbido corta	—	—	Función 5	Función f7	Función f7
Faros frontales a la cabina 1	—	—	 + 8	f0 + f8	f0 + f8
Ruido: interruptor general	—	—	—	Función f8	Función f8
Ruido: compresor	—	—	—	Función f9	Función f9
Luces de maniobra doble A	—	—	 + 1 + 8	f0 + f6 + f8	f0 + f6 + f8

Avvertenze per la sicurezza

- Tale locomotiva deve essere impiegata soltanto con un sistema di funzionamento adeguato per questa (Märklin AC, Märklin Delta, Märklin Digital oppure Märklin Systems).
- Impiegare soltanto alimentatori "switching" e trasformatori che corrispondono alla Vostra tensione di rete locale.
- La locomotiva non deve venire alimentata nello stesso tempo con più di una sorgente di potenza.
- Vogliate prestare assolutamente attenzione alle avvertenze di sicurezza nelle istruzioni di impiego per il Vostro sistema di funzionamento.
- Per il funzionamento tradizionale della locomotiva il binario di alimentazione deve essere protetto dai disturbi. A tale scopo si deve impiegare il corredo antidisturbi 74046. Tale corredo antidisturbi non è adatto per il funzionamento Digital.
- **AVVERTENZA!** Per motivi funzionali i bordi e le punte sono spigolosi.
- Non esponete tale modello ad alcun irraggiamento solare diretto, a forti escursioni di temperatura oppure a elevata umidità dell'aria.

Avvertenze generali









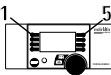

- Le istruzioni di impiego e l'imballaggio costituiscono un componente sostanziale del prodotto e devono pertanto venire conservati nonché consegnati insieme in caso di ulteriore cessione del prodotto.
- Per le riparazioni o le parti di ricambio, contrattare il rivenditore Märklin.
- Prestazioni di garanzia e garanzia in conformità

all'accluso certificato di garanzia.

- <http://www.maerklin.com/en/imprint.html>

Funzioni

- Riconoscimento del tipo di funzionamento: automatico.
- Indirizzi impostabili:
1-80 (Control Unit 6021/Mobile Station 60651/652)
1-255 (Central Station 6021x/Mobile Station 60653)
- Indirizzo di fabbrica: **62**
- Tecnologia Mfx per Mobile Station / Central Station.
Nome di fabbrica: **RE 6/6 11675**
- Ritardo di avviamento modificabile (ABV).
- Ritardo di frenatura modificabile (ABV).
- Velocità massima modificabile.
- Regolazione dei parametri della locomotiva (indirizzo, ritardo di avviamento/frenatura, velocità massima): tramite Control Unit, Mobile Station oppure Central Station.
- Illuminazione di testa dipendente dalla direzione di marcia.
- Nel funzionamento analogico si hanno a disposizione solamente le funzioni di marcia e di commutazione dei fanali.

Funzioni commutabili					 Digital / Systems
Illuminazione di testa	function/off			Funzione f0	Funzione f0
Faro di profondità	f1	Funzione 1	Funzione 3	Funzione f1	Funzione f1
Rumore: rumori di esercizio	f2	Funzione 2	Funzione 6	Funzione f2	Funzione f2
Rumore: fischio da locomotiva	f3	Funzione 3	Funzione 4	Funzione f3	Funzione f3
ABV	f4	Funzione 4	Funzione 2	Funzione f4	Funzione f4
Rumore: stridore dei freni escluso	—	—	Funzione 7	Funzione f5	Funzione f5
Illuminazione di testa della cabina 1 spento/accesa	—	—	 + 1	f0 + f6	f0 + f6
Rumore: fischio breve	—	—	Funzione 5	Funzione f7	Funzione f7
Illuminazione di testa della cabina 2 spento/accesa	—	—	 + 8	f0 + f8	f0 + f8
Rumore: interruttore principale	—	—	—	Funzione f9	Funzione f9
Rumore: compressore	—	—	—	Funzione f10	Funzione f10
Fanale di manovra a doppia A	—	—	 + 1 + 8	f0 + f6 + f8	f0 + f6 + f8

Säkerhetsanvisningar









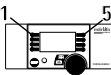

- Loket får endast köras med ett därtill avsett driftsystem (Märklin AC, Märklin Delta, Märklin Digital eller Märklin Systems).
- Använd endast nätadapterar och transformatorer anpassade för det lokala elnätet.
- Loket får inte samtidigt försörjas av mer än en kraftkälla.
- Beakta alltid säkerhetsanvisningarna i bruksanvisningen som hör till respektive driftsystemet.
- När motorvagnens lokdel ska köras med konventionell/ analog drift måste anslutningsskenan vara avstörd. Till detta använder man anslutningsgarnityr 74046 med avstörning och överbelastningsskydd. Avstörningsskyddet får inte användas vid digital körning.
- **WARNING!** Funktionsbetingade vassa kanter och spetsar.
- Modellen får inte utsättas för direkt solljus, häftiga temperaturväxlingar eller hög luftfuktighet.

Allmänna informationer

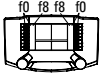
- Bruksanvisningen och förpackningen är en del av produkten och måste därför sparas och alltid medfölja produkten.
- Kontakta din Märklinfackhandlare för reparationer och reservdelar.
- Garantivillkor framgår av bifogade garantibevis.
- <http://www.maerklin.com/en/imprint.html>

Funktioner

- Driftsättet igenkänns automatiskt.
- Inställbara adresser:
1-80 (Control Unit 6021/Mobile Station 60651/652)
1-255 (Central Station 6021x/Mobile Station 60653)
- Adress från tillverkaren: **62**
- Mfx-teknologi för Mobile Station / Central Station. Namn från tillverkaren: **RE 6/6 11675**
- Accelerationsfördröjning kan ändras (ABV).
- Bromsfördröjning kan ändras (ABV).
- Toppfart kan ändras.
- Inställning av lokparametrar (Adress, acceleration/ bromsfördröjning, toppfart): Via Control Unit, Mobile Station eller Central Station.
- Körriktningsberoende frontbelysning.
- Vid analog körning är endast den automatiska ljusväxlingsfunktionen tillgänglig.

Kopplingsbara funktioner					 Digital / Systems
Frontstrålkastare	function/off			Funktion f0	Funktion f0
Fjärrljus	f1	Funktion 1	Funktion 3	Funktion f1	Funktion f1
Ljud: Trafikljud	f2	Funktion 2	Funktion 6	Funktion f2	Funktion f2
Ljud: Lokvissla	f3	Funktion 3	Funktion 4	Funktion f3	Funktion f3
ABV	f4	Funktion 4	Funktion 2	Funktion f4	Funktion f4
Ljud: Bromsgnissel, från	—	—	Funktion 7	Funktion f5	Funktion f5
Frontstrålkastare Förarhytt 2 från/till	—	—	 + 1	f0 + f6	f0 + f6
Ljud: Lokvissla kort	—	—	Funktion 5	Funktion f7	Funktion f7
Frontstrålkastare Förarhytt 1 från/till	—	—	 + 8	f0 + f8	f0 + f8
Ljud: Huvudströmbrytare	—	—	—	Funktion f9	Funktion f9
Ljud: Kompressor	—	—	—	Funktion f10	Funktion f10
Rangerljus dubbel A	—	—	 + 1 + 8	f0 + f6 + f8	f0 + f6 + f8

Vink om sikkerhed









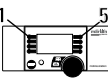

- Lokomotivet må kun bruges med et driftssystem (Märklin AC, Märklin Delta, Märklin Digital eller Märklin Systems), der er beregnet dertil.
- Anvend kun DC-DC-omformere og transformatorer, der passer til den lokale netspænding.
- Lokomotivet må ikke forsynes fra mere end én strømkilde ad gangen.
- Vær under alle omstændigheder opmærksom på de vink om sikkerhed, som findes i brugsanvisningen for Deres driftssystem.
- Ved konventionel drift af lokomotivet skal tilslutningssporet støjdæmpes. Dertil skal anvendes støjdæmpningssættet 74046. Støjdæmpningssættet er ikke egnet til digital drift.
- **ADVARSEL!** Skarpe kanter og spidser pga. funktionen.
- Modellen må ikke udsættes for direkte sollys, store temperaturudsving eller høj luftfugtighed.

Generelle oplysninger

- Betjeningsvejledning og emballage hører til produktet og skal derfor gemmes og medfølge, hvis produktet gives videre til andre.
- For reparation eller reservedele bedes De henvende Dem til Deres Märklinforhandler.
- Garanti ifølge vedlagte garantibevis.
- <http://www.maerklin.com/en/imprint.html>

Funktioner

- Registrering af driftsarten: automatisk.
- Indstillelige adresser:
1-80 (Control Unit 6021/Mobile Station 60651/652)
1-255 (Central Station 6021x/Mobile Station 60653)
- Adresse af fabrik: **62**
- Mfx-teknologi til Mobile Station / Central Station.
Navn af fabrik: **RE 6/6 11675**
- Indstillelig kørselsforsinkelse (ABV).
- Indstillelig bremseforsinkelse (ABV).
- Indstillelig maksimalhastighed.
- Indstilling af lokomotivparametrene (adresse, kørsels-/bremseforsinkelse, maksimalhastighed):
Via Control Unit, Mobile Station eller Central Station.
- Køreretningsafhængig frontbelysning.
- I analogdrift er det kun køre- og lysskiftefunktionerne, der er tilgængelige.

Styrbare funktioner					 Digital / Systems
Frontbelysning	function/off			Funktion f0	Funktion f0
Fjernlys	f1	Funktion 1	Funktion 3	Funktion f1	Funktion f1
Lyd: Driftslyd	f2	Funktion 2	Funktion 6	Funktion f2	Funktion f2
Lyd: Lokomotivfløjte	f3	Funktion 3	Funktion 4	Funktion f3	Funktion f3
ABV	f4	Funktion 4	Funktion 2	Funktion f4	Funktion f4
Lyd: Pibende bremses fra	—	—	Funktion 7	Funktion f5	Funktion f5
Frontbelysning Kabine 1 fra/til	—	—	 + 1	f0 + f6	f0 + f6
Lyd: Lokomotivfløjte kort	—	—	Funktion 5	Funktion f7	Funktion f7
Frontbelysning Kabine 2 fra/til	—	—	 + 8	f0 + f8	f0 + f8
Lyd: Hovedafbryder	—	—	—	Funktion f9	Funktion f9
Lyd: Kompressor	—	—	—	Funktion f10	Funktion f10
Rangerlys dobbelt A	—	—	 + 1 + 8	f0 + f6 + f8	f0 + f6 + f8

CV (Parameter) • CV (Parameter) • CV (Paramètre) • CV (Parameter) • CV (Parámetro) • CV (Parametro) • CV (Parameter) • CV (Parameter)	CV-Nr.	Wert • Value • Valeur • Waarde • Valor • Valore • Värde • Værdi
Adresse • Address • Adresse • Adres • Código • Indirizzo • Adress • Adresse	01	01 - (80)* 255
Anfahrverzögerung • Acceleration delay • Temporisation accélération • Optrekvertraging • Regulación arranque • Ritardo di avviamento • Ilgångsättningsreglering • Kørselsforsinkelse	03	01 - (63)* 255
Bremsverzögerung • Braking delay • Temporisation de freinage • Afremvertraging • Frenado lento • Ritardo di frenatura • Bromsfödröjning • Bremseforsinkelse	04	01 - (63)* 255
Höchstgeschwindigkeit • Maximum speed • Vitesse maximale • Maximumsneilheid • Velocidad máxima • Velocità massima • Toppfart • Maksimalhastighed	05	01 - (63)* 255
Rückstellen auf Serienwerte • Reset to series value • Remettre aux valeurs de série • Terugzetten naar serie-instellingen • Restablecer los valores de serie • Ripristinare sui valori di serie • Återställa till standardvärden • Tibagestil til serieværdien	08	08
Lautstärke • Volume • Volume haut-parleur • Volume • Volumen del sonido • Intensità del suono • Ljudstyrka • Lydstyrke	63	01- (63)* 255

* () = Control Unit 6021/Mobile Station 60651/653

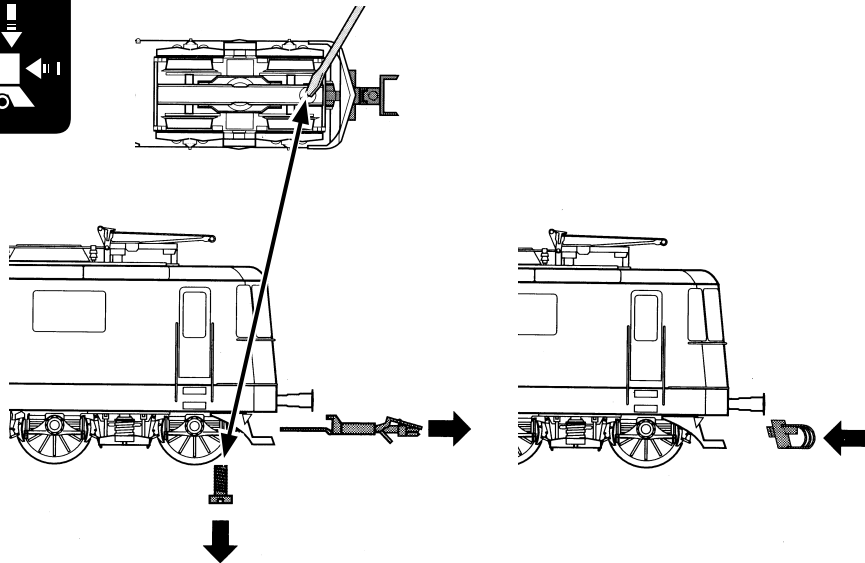

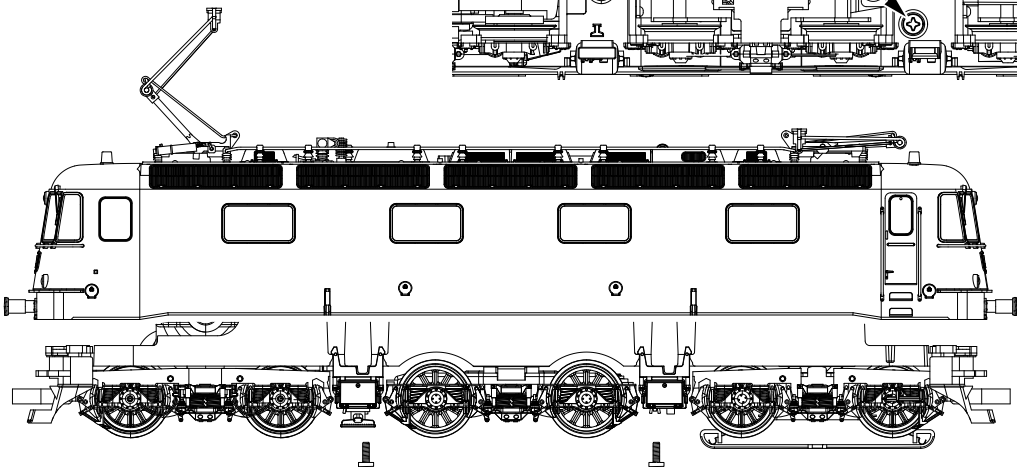

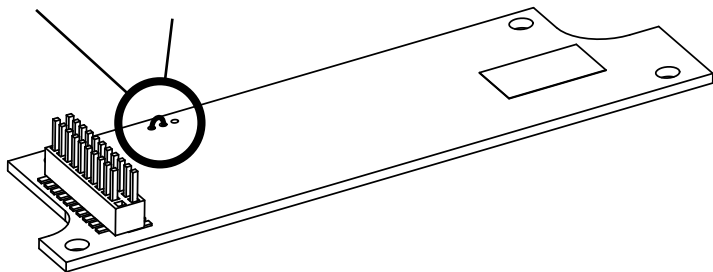
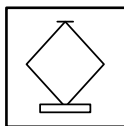
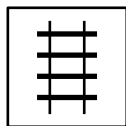

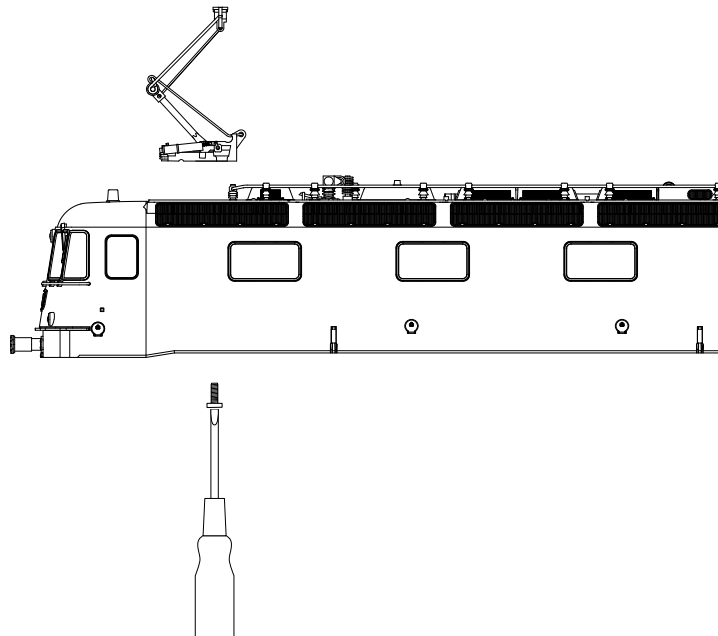
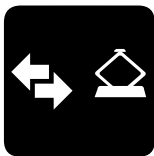

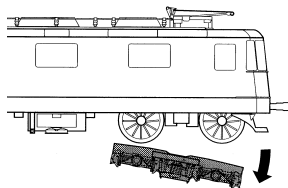
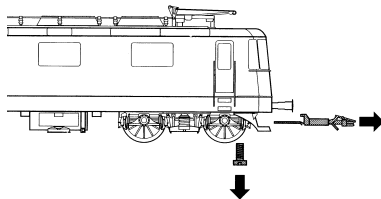
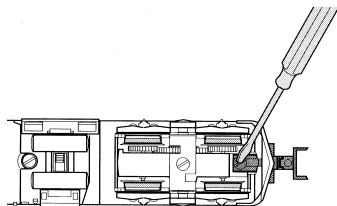
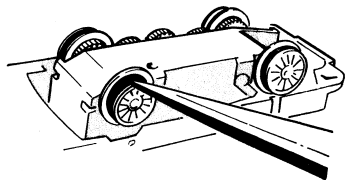

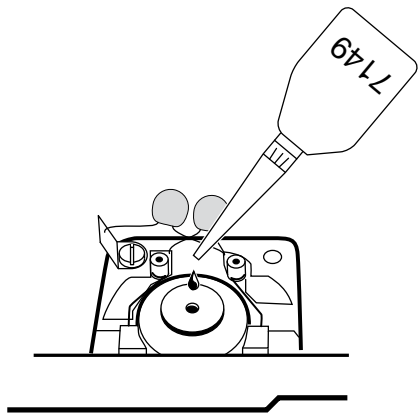
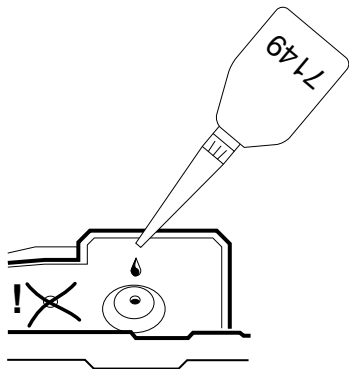

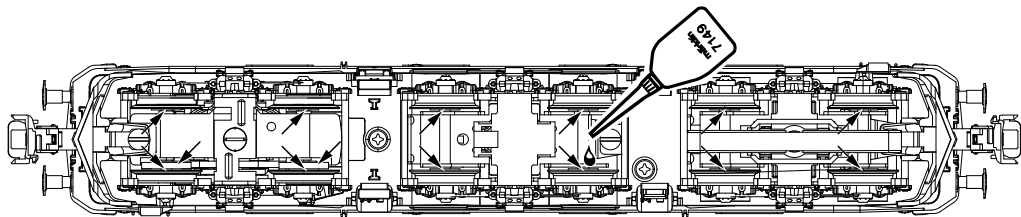

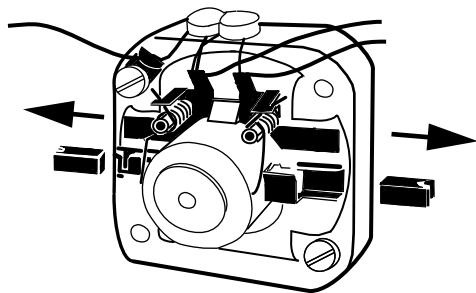
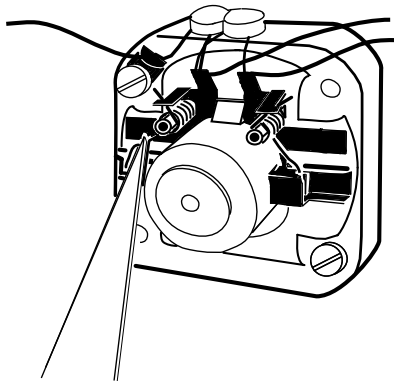
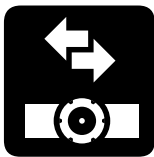

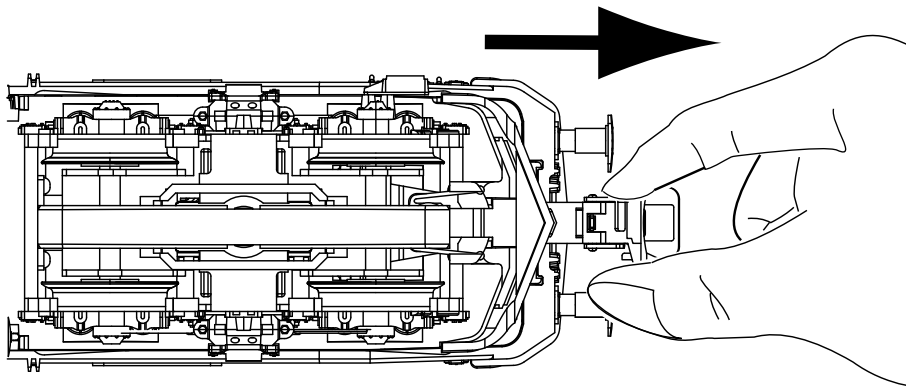

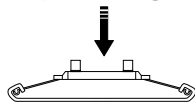
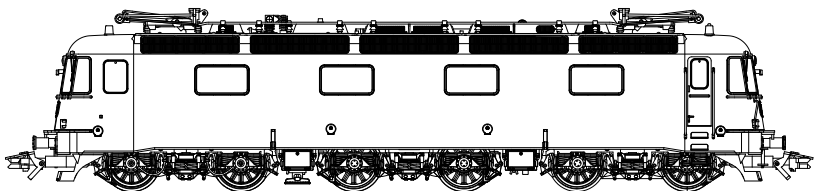
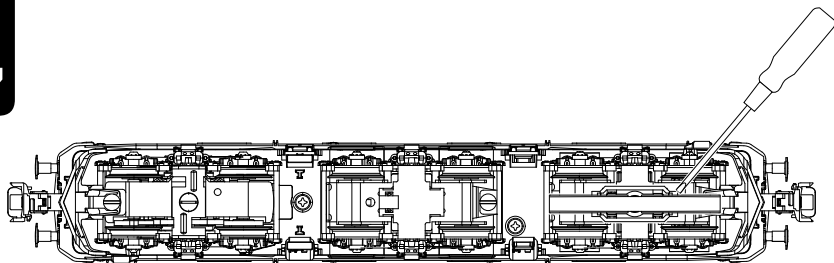
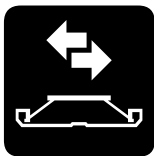

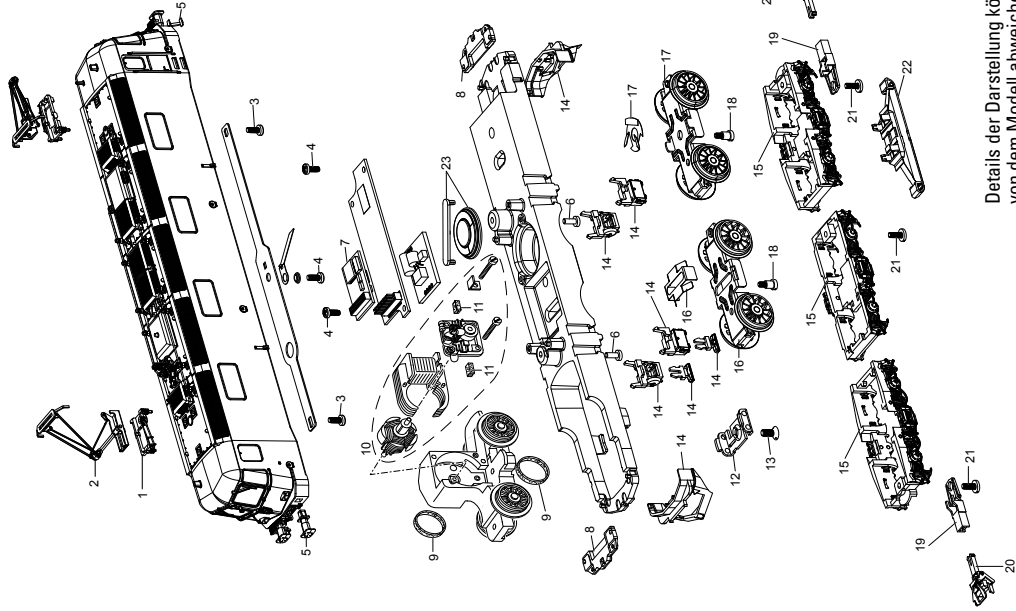

Details der Darstellung können von dem Modell abweichen.

1	Trägerisolation	E162 509
2	Einholm Stromabnehmer	E162 508
3	Schraube	E750 250
4	Schraube	E786 750
5	Steckteile	E176 160
6	Schraube	E785 070
7	Decoder	188 439
8	Beleuchtungseinheit	E154 574
9	Haftreifen	7 153
10	Motor	E167 218
11	Graphitbürste	E601 460
12	Stützblech	E214 620
13	Schraube	E786 190
14	Steckteile	E166 207
15	Drehgestellblende	E190 936
16	Drehgestell	E192 578
17	Drehgestell	E192 579
18	Schraube	E753 510
19	Kupplungsdeichsel	E138 471
20	Kurzkupplung	E701 630
21	Schraube	E750 200
22	Schleifer	E206 370
23	Lautsprecher	E182 576

Hinweis: Einige Teile werden nur ohne oder mit anderer Farbgebung angeboten.

Teile, die hier nicht aufgeführt sind, können nur im Rahmen einer Reparatur im Märklin Reparatur-Service repariert werden.

This device complies with Part 15 of the FCC Rules.

Operation is subject to the following two conditions:

- (1) This device may not cause harmful interference, and
- (2) this device must accept any interference received, including interference that may cause undesired operation.