

Modell der Reihe E10

36334

Inhaltsverzeichnis:	Seite	Sommaire :	Page
Sicherheitshinweise	4	Remarques importantes sur la sécurité	8
Wichtige Hinweise	4	Information importante	8
Funktionen	4	Fonctionnement	8
Schaltbare Funktionen	5	Fonctions commutables	9
Parameter / Register	20	Paramètre / Registre	20
Betriebshinweise	21	Remarques sur l'exploitation	21
Wartung und Instandhaltung	23	Entretien et maintien	23
Ersatzteile	26	Pièces de rechange	26

Table of Contents:	Page	Inhoudsopgave:	Pagina
Safety Notes	6	Veiligheidsvoorschriften	10
Important Notes	6	Belangrijke aanwijzing	10
Functions	6	Functies	10
Controllable Functions	7	Schakelbare functies	11
Parameter / Register	20	Parameter / Register	20
Information about operation	21	Opmerkingen over de werking	21
Service and maintenance	23	Onderhoud en handhaving	23
Spare Parts	29	Onderdelen	26

Indice de contenido:	Página	Innehållsförteckning:	Sidan
Aviso de seguridad	12	Säkerhetsanvisningar	16
Notas importantes	12	Viktig information	16
Funciones	12	Funktioner	16
Funciones posibles	13	Kopplingsbara funktioner	17
Parámetro / Registro	20	Parameter / Register	20
Instrucciones de uso	21	Driftanvisningar	21
El mantenimiento	23	Underhåll och reparation	23
Recambios	26	Reservdelar	26

Indice del contenido:	Página	Indholdsfortegnelse:	Side
Avvertenze per la sicurezza	14	Vink om sikkerhed	18
Avvertenze importanti	14	Vigtige bemærkninger	18
Funzioni	14	Funktioner	18
Funzioni commutabili	15	Styrbare funktioner	19
Parametro / Registro	20	Parameter / Register	20
Avvertenze per il funzionamento	21	Brugsanvisninger	21
Manutenzione ed assistere	23	Service og reparation	23
Pezzi di ricambio	26	Reserve dele	26

Sicherheitshinweise





- Die Lok darf nur mit einem dafür bestimmten Betriebssystem (Märklin AC, Märklin Delta, Märklin Digital oder Märklin Systems) eingesetzt werden.
- Nur Schaltnetzteile/Transformatoren verwenden, die Ihrer örtlichen Netzspannung entsprechen.
- Die Lok darf nur aus einer Leistungsquelle versorgt werden.
- Beachten Sie unbedingt die Sicherheitshinweise in der Bedienungsanleitung zu Ihrem Betriebssystem.
- Für den konventionellen Betrieb der Lok muss das Anschlussgleis entstört werden. Dazu ist das Entstörset 74046 zu verwenden. Für Digitalbetrieb ist das Entstörset nicht geeignet.
- Setzen Sie das Modell keiner direkten Sonneneinstrahlung, starken Temperaturschwankungen oder hoher Luftfeuchtigkeit aus.
- **ACHTUNG!** Funktionsbedingte scharfe Kanten und Spitzen.

Wichtige Hinweise

- Die Bedienungsanleitung und die Verpackung sind Bestandteile des Produktes und müssen deshalb aufbewahrt sowie bei Weitergabe des Produktes mitgegeben werden.
- Wartung, Instandhaltung und Reparaturen dürfen nur durch Erwachsene durchgeführt werden.
- Für Reparaturen oder Ersatzteile wenden Sie sich bitte an Ihren Märklin-Fachhändler.
- Gewährleistung und Garantie gemäß der beiliegenden Garantieurkunde.
- Entsorgung: www.maerklin.com/en/imprint.html

Funktionen

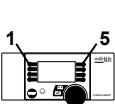
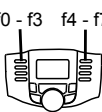
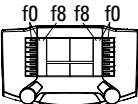
- Erkennung der Betriebsart: automatisch.
- Einstellbare Adressen:
1-80 (Control Unit 6021/Mobile Station 60651/652)
1-255 (Central Station 6021x/Mobile Station 60653)
- Adresse ab Werk: **33**
- Mfx-Technologie für Mobile Station / Central Station.
Name ab Werk: **EL 10.2505 NSB**
- Veränderbare Anfahrverzögerung (ABV).
- Veränderbare Bremsverzögerung (ABV).
- Veränderbare Höchstgeschwindigkeit.
- Einstellen der Lokparameter (Adresse, Anfahr-/Bremsverzögerung, Höchstgeschwindigkeit):
über Control Unit, Mobile Station oder Central Station.

Schaltbare Funktionen					
Stirnbeleuchtung, gedimmt	function/off			Funktion f0	Funktion f0
Rangiergang	f1	f1	Funktion 1	Funktion f1	Funktion f1
ABV, aus	f4	Funktion 4	Funktion 4	Funktion f4	Funktion f4

Safety Notes





- This locomotive is to be used only with an operating system designed for it (Märklin AC, Märklin Delta, Märklin Digital or Märklin Systems).
- Use only switched mode power supply units and transformers that are designed for your local power system.
- This locomotive must never be supplied with power from more than one transformer.
- Pay close attention to the safety notes in the instructions for your operating system.
- The feeder track must be equipped to prevent interference with radio and television reception, when the locomotive is to be run in conventional operation. The 74046 interference suppression set is to be used for this purpose.
- Do not expose the model to direct sunlight, extreme changes in temperature, or high humidity.
- **WARNING!** Sharp edges and points required for operation.

Important Notes

- The operating instructions and the packaging are a component part of the product and must therefore be kept as well as transferred along with the product to others.
- Maintenance, servicing, and repairs may only be done by adults.
- Please see your authorized Märklin dealer for repairs or spare parts.
- The warranty card included with this product specifies the warranty conditions.
- Disposing: www.maerklin.com/en/imprint.html

Functions

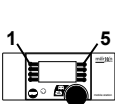
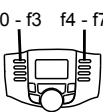
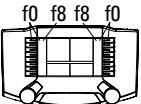
- Recognition of the mode of operation: automatic.
- Addresses that can be set:
1-80 (Control Unit 6021/Mobile Station 60651/652)
1-255 (Central Station 6021x/Mobile Station 60653)
- Address set at the factory: **33**
- Mfx technology for the Mobile Station / Central Station.
Name set at the factory: **EL 10.2505 NSB**
- Adjustable Acceleration delay (ABV).
- Adjustable Braking delay (ABV).
- Adjustable maximum speed.
- Setting the locomotive parameters (address, acceleration/braking delay, maximum speed):
with the Control Unit, Mobile Station, Central Station.

Controllable Functions					
Headlights, dimmed	function/off			Function f0	Function f0
Low speed switching range	f1	f1	Function 1	Function f1	Function f1
ABV, off	f4	Function 4	Function 4	Function f4	Function f4

Remarques importantes sur la sécurité

- La locomotive ne peut être mise en service qu'avec un système d'exploitation adéquat (Märklin AC, Märklin Delta, Märklin Digital ou Märklin Systems).
- Utiliser uniquement des convertisseurs et transformateurs correspondant à la tension du secteur local.
- La locomotive ne peut être alimentée en courant que par une seule source de courant.
- Veuillez impérativement respecter les remarques sur la sécurité décrites dans le mode d'emploi de votre système d'exploitation.
- Pour l'exploitation de la locomotive en mode conventionnel, la voie de raccordement doit être déparasitée. A cet effet, utiliser le set de déparasitage réf. 74046. Le set de déparasitage ne convient pas pour l'exploitation en mode numérique.
- Ne pas exposer le modèle à un ensoleillement direct, à de fortes variations de température ou à un taux d'humidité important.
- **ATTENTION!** Pointes et bords coupants lors du fonctionnement du produit.

Information importante







- La notice d'utilisation et l'emballage font partie intégrante du produit ; ils doivent donc être conservés et, le cas échéant, transmis avec le produit.
- Seules des personnes adultes sont habilitées pour l'entretien, la maintenance et les réparations.
- Pour toute réparation ou remplacement de pièces, adressez-vous à votre détaillant-spécialiste Märklin.
- Garantie légale et garantie contractuelle conformément

au certificat de garantie ci-joint.

- Elimination : www.maerklin.com/en/imprint.html

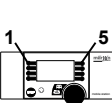
Fonctionnement

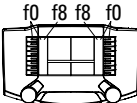
- Détection du mode d'exploitation : automatique.
- Adresses disponibles :
 - 1-80** (Control Unit 6021/Mobile Station 60651/652)
 - 1-255** (Central Station 6021x/Mobile Station 60653)
- Adresse encodée en usine : **33**
- Technologie mfx pour Mobile Station / Central Station.
Nom encodée en usine : **EL 10.2505 NSB**
- Temporisation d'accélération réglable (ABV).
- Temporisation de freinage réglable (ABV).
- Vitesse maximale réglable.
- Réglage des paramètres de la loco (adresse, temporisation accélér.-freinage, vitesse maximale) :
via Control Unit, Mobile Station ou Central Station.

Fonctions commutables				f0 - f3 f4 - f7 	 Digital/Systems
Fanal	function/off			Fonction f0	Fonction f0
Vitesse de manœuvre	f1	f1	Fonction 1	Fonction f1	Fonction f1
ABV, désactivé	f4	Fonction 4	Fonction 4	Fonction f4	Fonction f4

Veiligheidsvoorschriften





- De loc mag alleen met een daarvoor bestemd bedrijfs-systeem (Märklin AC, Märklin Delta, Märklin digitaal of Märklin Systems) gebruikt worden.
- Alleen net-adapters en transformatoren gebruiken waarvan de aangegeven netspanning overeenkomt met de netspanning ter plaatse.
- De loc mag niet vanuit meer dan een stroomvoorziening gelijktijdig gevoed worden.
- Lees ook aandachtig de veiligheidsvoorschriften in de gebruiksaanwijzing van uw bedrijfssysteem.
- Voor het conventionele bedrijf met de loc dient de aansluitrail te worden ontstoort. Hiervoor dient men de ontstoor-set 74046 te gebruiken. Voor het digitale bedrijf is deze ontstoor-set niet geschikt.
- Stel het model niet bloot aan in directe zonnestraling, sterke temperatuurwisselingen of hoge luchtvochtigheid.
- **OPGEPAST!** Functionele scherpe kanten en punten.

Belangrijke aanwijzing

- De gebruiksaanwijzing en de verpakking zijn een bestanddeel van het product en dienen derhalve bewaard en meegeleverd te worden bij het doorgeven van het product.
- Onderhoud, herstellingen en reparaties mogen alleen door volwassenen uitgevoerd worden.
- Voor reparatie of onderdelen kunt u zich tot uw Märklin handelaar wenden.
- Vrijwaring en garantie overeenkomstig het bijgevoegde garantiebewijs.
- Afdanken: www.maerklin.com/en/imprint.html

Funcities

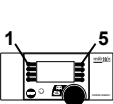
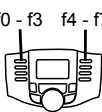
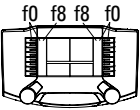
- Herkenning van het bedrijfssysteem: automatisch.
- Instelbare adressen:
 - 1-80** (Control Unit 6021/Mobile Station 60651/652)
 - 1-255** (Central Station 6021x/Mobile Station 60653)
- Vanaf de fabriek ingesteld: **33**
- Mfx-technologie voor het Mobile Station/Central Station. Naam af de fabriek: **EL 10.2505 NSB**
- Instelbare optrekvertraging (ABV).
- Instelbare afremvertraging (ABV).
- Instelbare maximumsnelheid.
- Instellen van de locomotiefparameters (adres, optrek-/afremvertraging, maximumsnelheid):
d.m.v. Control Unit, Mobile Station of Central Station.

Schakelbare functies					 Digital/Systems
Frontverlichting	function/off			Functie f0	Functie f0
Rangeerstand	f1	f1	Functie 1	Functie f1	Functie f1
ABV, uit	f4	Functie 4	Functie 4	Functie f4	Functie f4

Aviso de seguridad

- La locomotora solamente debe funcionar en un sistema de corriente propio (Märklin AC – Märklin Delta – Märklin Digital o Märklin Systems).
- Emplear únicamente fuentes de alimentación conmutadas y transformadores que sean de la tensión de red local.
- La alimentación de la locomotora deberá realizarse desde una sola fuente de suministro.
- Observe bajo todos los conceptos, las medidas de seguridad indicadas en las instrucciones de su sistema de funcionamiento.
- Para el funcionamiento convencional de la locomotora deben suprimirse las interferencias en la vía de conexión de la alimentación. Para ello debe emplearse el set supresor de interferencias 74046. El set supresor de interferencias no es adecuado para el funcionamiento en modo digital.
- No exponer el modelo en miniatura a la radiación solar directa, a oscilaciones fuertes de temperatura o a una humedad del aire elevada.
- **¡ATENCIÓN!** Esquinas y puntas afiladas condicionadas a la función.







Notas importantes

- Las instrucciones de empleo y el embalaje forman parte íntegra del producto y, por este motivo, deben guardarse y entregarse junto con el producto en el caso de venderlo o transmitirlo a otro.
- El mantenimiento, la conservación y las reparaciones deben ser realizadas siempre por adultos.
- Para reparaciones o recambios contacte con su proveedor Märklin especializado.

- Responsabilidad y garantía conforme al documento de garantía que se adjunta.
- Eliminación: www.maerklin.com/en/imprint.html

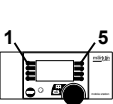
Funciones

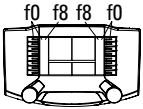
- Reconocimiento del sistema: automático.
- Códigos disponibles:
 - 1-80** (Control Unit 6021/Mobile Station 60651/652)
 - 1-255** (Central Station 6021x/Mobile Station 60653)
- Código de fábrica: **33**
- Tecnología mfx para la Mobile Station/Central Station.
Nombre de fábrica: **EL 10.2505 NSB**
- Arranque lento variable (ABV).
- Frenado lento variable (ABV).
- Velocidad máxima variable.
- Fijar parámetros de la locomotora (código, arranque y frenado, velocidad máxima):
por el Control Unit, Mobile Station o Central Station.

Funciones posibles				f0 - f3 f4 - f7 	 Digital/Systems
Alumbrado de cabeza, atenuado	function/off			Función f0	Función f0
Marcha de maniobra (sólo ABV)	f1	f1	Función 1	Función f1	Función f1
ABV, apagado	f4	Función 4	Función 4	Función f4	Función f4

Avvertenze per la sicurezza

- Tale locomotiva deve essere impiegata soltanto con un sistema di funzionamento adeguato per questa (Märklin AC, Märklin Delta, Märklin Digital oppure Märklin Systems).
- Impiegare soltanto alimentatori "switching" e trasformatori che corrispondono alla Vostra tensione di rete locale.
- La locomotiva non deve venire alimentata nello stesso tempo con più di una sorgente di potenza.
- Vogliate prestare assolutamente attenzione alle avvertenze di sicurezza nelle istruzioni di impiego per il Vostro sistema di funzionamento.
- Per il funzionamento tradizionale della locomotiva il binario di alimentazione deve essere protetto dai disturbi. A tale scopo si deve impiegare il corredo antidisturbi 74046. Tale corredo antidisturbi non è adatto per il funzionamento Digital.
- Non esponete tale modello ad alcun irraggiamento solare diretto, a forti escursioni di temperatura oppure a elevata umidità dell'aria.
- **AVVERTENZA!** Per motivi funzionali i bordi e le punte sono spigolosi.

Avvertenze importanti







- Le istruzioni di impiego e l'imballaggio costituiscono un componente sostanziale del prodotto e devono pertanto venire conservati nonché consegnati insieme in caso di ulteriore cessione del prodotto.
- Manutenzione, tenuta in efficienza e riparazioni possono venire eseguite soltanto da parte di adulti.
- Per le riparazioni o le parti di ricambio, contrattare il rivenditore Märklin.
- Prestazioni di garanzia e garanzia in conformità

all'accluso certificato di garanzia.

- Smaltimento: www.maerklin.com/en/imprint.html

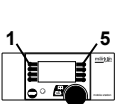
Funzioni

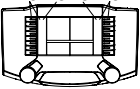
- Riconoscimento del tipo di funzionamento: automatico.
- Indirizzi impostabili:
1-80 (Control Unit 6021/Mobile Station 60651/652)
1-255 (Central Station 6021x/Mobile Station 60653)
- Indirizzo di fabbrica: **33**
- Tecnologia Mfx per Mobile Station / Central Station.
Nome di fabbrica: **EL 10.2505 NSB**
- Ritardo di avviamento modificabile (ABV).
- Ritardo di frenatura modificabile (ABV).
- Velocità massima modificabile.
- Regolazione dei parametri della locomotiva (indirizzo, ritardo di avviamento/frenatura, velocità massima): tramite Control Unit, Mobile Station oppure Central Station.

Funzioni commutabili				f0 - f3 f4 - f7 	 Digital/Systems
Illuminazione di testa, attenuata	function/off			Funzione f0	Funzione f0
Andatura da manovra	f1	f1	Funzione 1	Funzione f1	Funzione f1
ABV, spente	f4	Funzione 4	Funzione 4	Funzione f4	Funzione f4

Säkerhetsanvisningar





- Loket får endast köras med ett därtill avsett driftsystem (Märklin AC, Märklin Delta, Märklin Digital eller Märklin Systems).
- Använd endast nätadapterar och transformatorer anpassade för det lokala elnätet.
- Loket får inte samtidigt försörjas av mer än en kraftkälla.
- Beakta alltid säkerhetsanvisningarna i bruksanvisningen som hör till respektive driftsystemet.
- När motorvagnens lokdel ska köras med konventionell/ analog drift måste anlutningsskenan vara avstörd. Till detta använder man anslutningsgarnityr 74046 med avstörning och överbelastningsskydd. Avstörningsskyddet får inte användas vid digital körning.
- Modellen får inte utsättas för direkt solljus, häftiga temperaturväxlingar eller hög luftfuktighet.
- **WARNING!** Funktionsbetingade vassa kanter och spetsar.

Viktig information

- Bruksanvisningen och förpackningen är en del av produkten och måste därför sparas och alltid medfölja produkten.
- Underhåll, service och reparationer får endast utföras av vuxna personer.
- Kontakta din Märklinackhandlare för reparationer och reservdelar.
- Garantivillkor framgår av bifogade garantibevis.
- Hantering som avfall: www.maerklin.com/en/imprint.html

Funktioner

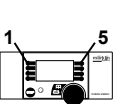
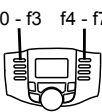
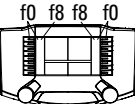
- Driftsättet igenkänns automatiskt.
- Inställbara adresser:
 - 1-80** (Control Unit 6021/Mobile Station 60651/652)
 - 1-255** (Central Station 6021x/Mobile Station 60653)
- Adress från tillverkaren: **33**
- Mfx-teknologi för Mobile Station / Central Station. Namn från tillverkaren: **EL 10.2505 NSB**
- Accelerationsfördröjning kan ändras (ABV).
- Bromsfördröjning kan ändras (ABV).
- Toppfart kan ändras.
- Inställning av lokparametrar (Adress, acceleration/bromsfördröjning, toppfart):
Via Control Unit, Mobile Station eller Central Station.

Kopplingsbara funktioner					 Digital/Systems
Frontstrålkastare, dämpade	function/off			Funktion f0	Funktion f0
Rangerkörning	f1	f1	Funktion 1	Funktion f1	Funktion f1
ABV, från	f4	Funktion 4	Funktion 4	Funktion f4	Funktion f4

Vink om sikkerhed





- Lokomotivet må kun bruges med et driftssystem (Märklin AC, Märklin Delta, Märklin Digital eller Märklin Systems), der er beregnet dertil.
- Anvend kun DC-DC-omformere og transformatorer, der passer til den lokale netspænding.
- Lokomotivet må ikke forsynes fra mere end én strømkilde ad gangen.
- Vær under alle omstændigheder opmærksom på de vink om sikkerhed, som findes i brugsanvisningen for Deres driftssystem.
- Ved konventionel drift af lokomotivet skal tilslutningssporet støjdæmpes. Dertil skal anvendes støjdæmpningssættet 74046. Støjdæmpningssættet er ikke egnet til digital drift.
- Modellen må ikke udsættes for direkte sollys, store temperaturudsving eller høj luftfugtighed.
- **ADVARSEL!** Skarpe kanter og spidser pga. funktionen.

Vigtige bemærkninger

- Betjeningsvejledning og emballage hører til produktet og skal derfor gemmes og medfølge, hvis produktet gives videre til andre.
- Service, vedligeholdelse og reparationer må kun udføres af voksne.
- For reparation eller reservedele bedes De henvende Dem til Deres Märklinforhandler.
- Garanti ifølge vedlagte garantibevis.
- Bortskafning: www.maerklin.com/en/imprint.html

Funktioner

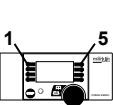
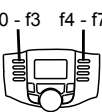
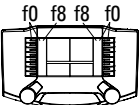
- Registrering af driftsarten: automatisk.
- Indstillelige adresser:
 - 1-80** (Control Unit 6021/Mobile Station 60651/652)
 - 1-255** (Central Station 6021x/Mobile Station 60653)
- Adresse af fabrikk: **33**
- Mfx-teknologi til Mobile Station / Central Station.
Navn af fabrikk: **EL 10.2505 NSB**
- Indstillelig kørselsforsinkelse (ABV).
- Indstillelig bremseforsinkelse (ABV).
- Indstillelig maksimalhastighed.
- Indstilling af lokomotivparametrene (adresse, kørsels-/bremseforsinkelse, maksimalhastighed):
Via Control Unit, Mobile Station eller Central Station.

Styrbare funktioner					 Digital/Systems
Frontbelysning	function/off			Funktion f0	Funktion f0
Rangergear	f1	f1	Funktion 1	Funktion f1	Funktion f1
ABV, fra	f4	Funktion 4	Funktion 4	Funktion f4	Funktion f4

CV (Parameter) • CV (Parameter) • CV (Paramètre) • CV (Parameter) • CV (Parámetro) • CV (Parametro) • CV (Parameter) • CV (Parameter)	CV-Nr.	Wert • Value • Valeur • Waarde • Valor • Valore • Värde • Værdi
Adresse • Address • Adresse • Adres • Código • Indirizzo • Adres • Adresse	01	01 - (80)* 255
Anfahrverzögerung • Acceleration delay • Temporisation accélération • Optrekvertraging • Regulación arranque • Ritardo di avviamento • Igångsättningsreglering • Kørselsforsinkelse	03	01 - (63)* 255
Bremsverzögerung • Braking delay • Temporisation de freinage • Afremvertraging • Frenado lento • Ritardo di frenatura • Bromsfördröjning • Bremseforsinkelse	04	01 - (63)* 255
Höchstgeschwindigkeit • Maximum speed • Vitesse maximale • Maximumsneilheid • Velocidad máxima • Velocità massima • Toppfart • Maksimalhastighed	05	01 - (63)* 255
Rückstellen auf Serienwerte • Reset to series value • Remettre aux valeurs de série • Terugzetten naar serie-instellingen • Restablecer los valores de serie • Ripristinare sui valori di serie • Återställa till standardvärden • Tibagestil til serieværdien	08	08

* () = Control Unit 6021 / Mobile Station 60651/60652

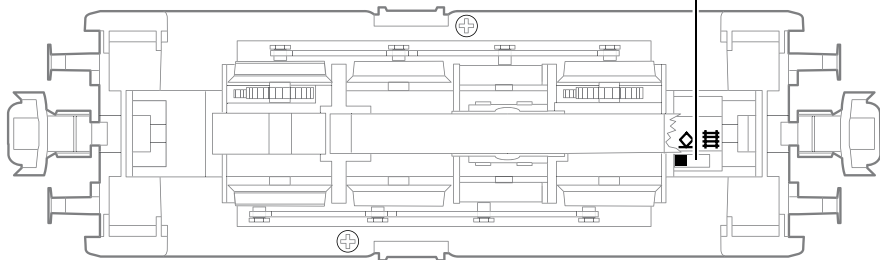
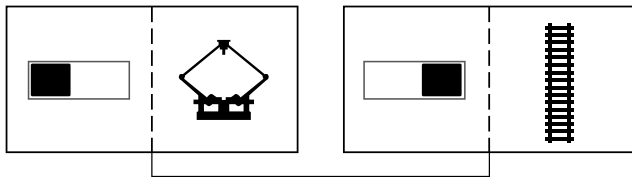
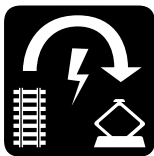

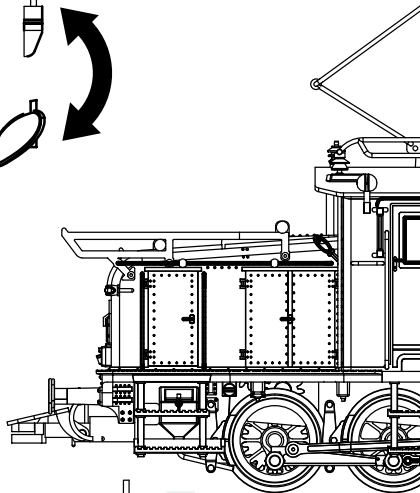
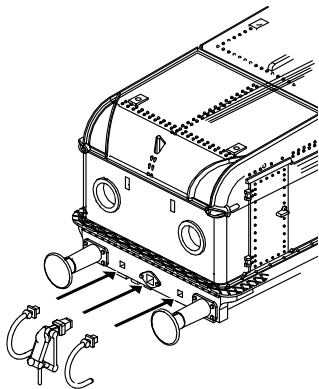
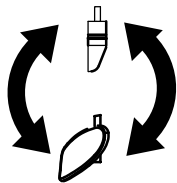

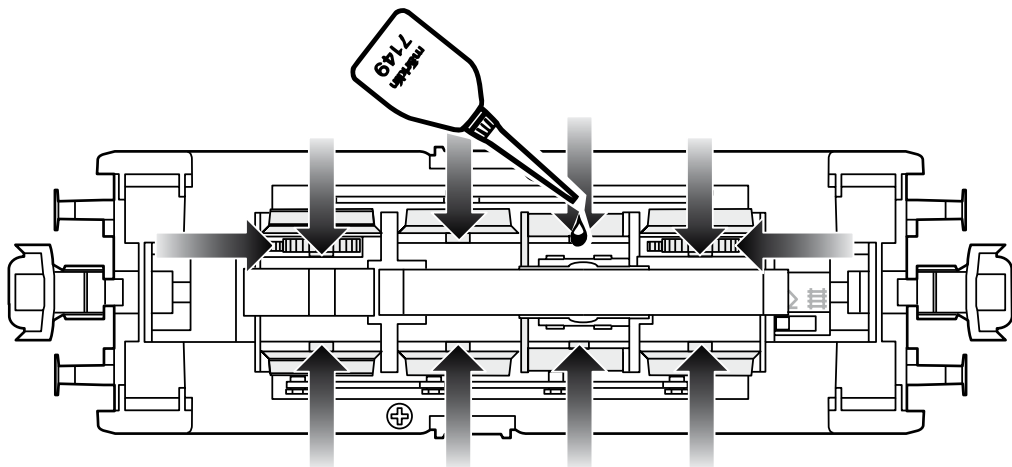

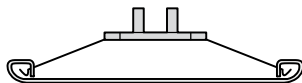
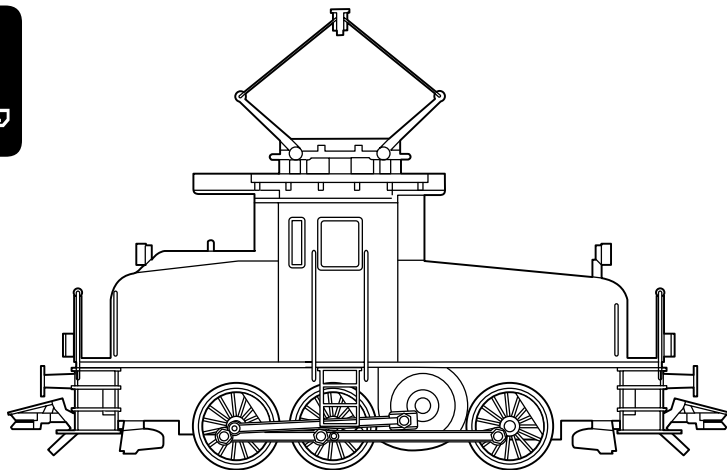
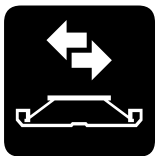

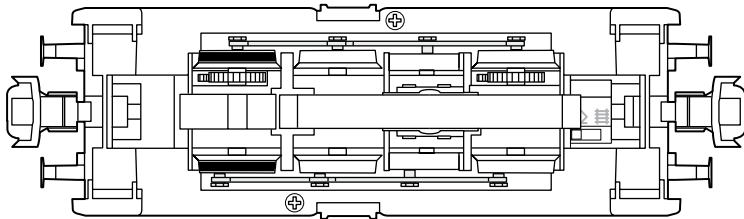
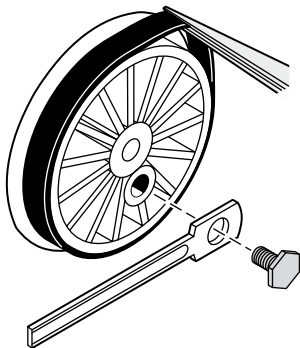
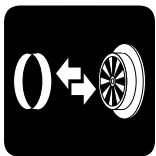

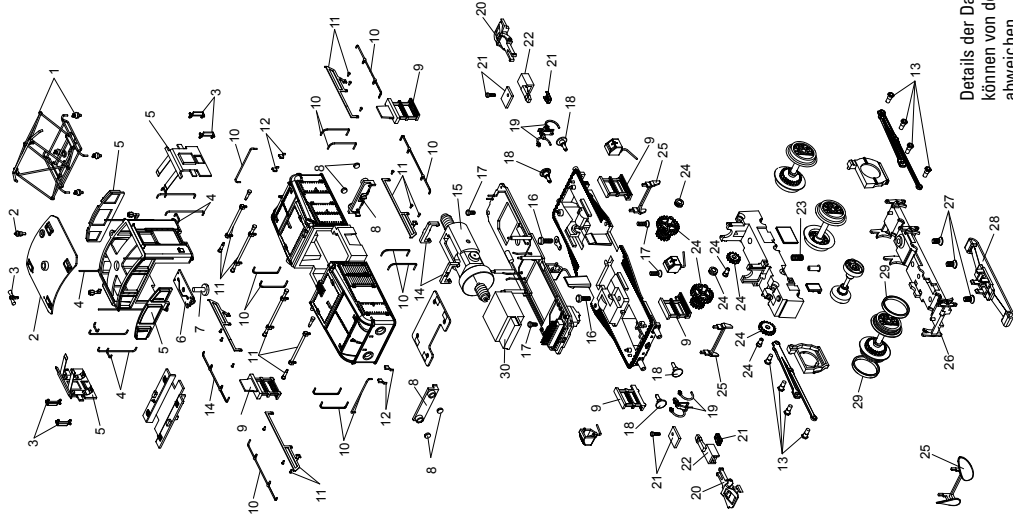

Details der Darstellung
können von dem Modell
abweichen.

1	Stromabnehmer mit Isolatoren	E318 572
2	Dach	E190 365
3	Kleinteile-Führerhaus	E116 216
4	Handstangen-Führerhaus	E235 035
5	Fenster	E235 036
6	Leiterplatte Führerhaus	E314 356
7	Schraube	E318 578
8	Lampe Lokgehäuse	E198 851
9	Treppen	E194 542
10	Griffstangen	E235 037
11	Laufschienen	E235 038
12	Kleinteile-Vorbau	E116 224
13	Schraube	E311 689
14	Motorhalter	E22 4127 00
15	Motor	E311 622
16	Schraube	E321 098
17	Schraube	E101 062
18	Puffer	E194 545
19	Haken u. Bremsleitungen	E32 2551 30
20	Kurzkupplung	E701 630
21	Kupplung	E311 709
22	Kupplungshalter	E311 642
23	Druckfeder	E214 330
24	Zahnräder, Bolzen, Buchsen	E185 240
25	Schienenräumer	E185 239
26	Achsabdeckung	E314 298
27	Schraube	E321 287
28	Schleifer	E306 328
29	Haftreifen	7 154
30	Decoder	198 734
	Zugvorricht. Bremsleitung	E311 711

Hinweis: Einige Teile werden nur ohne oder mit anderer Farbgebung angeboten.

Teile, die hier nicht aufgeführt sind, können nur im Rahmen einer Reparatur im Märklin-Reparatur-Service repariert werden.

Due to different legal requirements regarding electro-magnetic compatibility, this item may be used in the USA only after separate certification for FCC compliance and an adjustment if necessary.

Use in the USA without this certification is not permitted and absolves us of any liability. If you should want such certification to be done, please contact us – also due to the additional costs incurred for this.

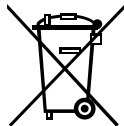

Gebr. Märklin & Cie. GmbH
Stuttgarter Str. 55 - 57
73033 Göppingen
Germany
www.maerklin.com

www.maerklin.com/en/imprint.html

233141/0613/Sm1CI
Änderungen vorbehalten
© Gebr. Märklin & Cie. GmbH