

# STADTKIRCHE

TOWN CHURCH  
ÉGLISE URBAINE  
STADSKERK



Art. Nr. 232271

**D**

Vor Beginn des Bastelns sollten Sie sich mit den Spritzlingen und der Anleitung vertraut machen. Sollte es einmal vorkommen, dass ein Teil im Bausatz fehlt, kreuzen Sie bitte das fehlende Teil in der Anleitung an und schicken Sie diese bitte an Fa. Gebr. FALLER GmbH, Abt. Kundendienst, kundendienst@faller.de, Kreuzstraße 9, 78148 Gütenbach. Sie erhalten dann umgehend Ersatz. Es kann vorkommen, dass bei einem Bausatz Einzelteile übrig sind.

**GB**

Before beginning with the assembly please familiarize yourself with the parts and read the instructions carefully. In case of missing parts please indicate these on the instructions leaflet with a circle and return the leaflet to Gebr. FALLER GmbH, kundendienst@faller.de, Kreuzstraße 9, D-78148 Gütenbach, Germany. You will receive the replacement by return. It may happen in a kit that some parts are not required.

**F**

Avant de commencer le montage de votre maquette bien lire la notice et repérer les grappes. Si une pièce manque dans une boîte, cochez la pièce correspondante sur la notice et renvoyez-la-nous à Gebr. FALLER GmbH, kundendienst@faller.de, Kreuzstraße 9, D-78148 Gütenbach (R.F.A.). Nous vous ferons parvenir la pièce par retour. Dans certains kits, il est possible que certaines pièces ne soient pas utilisées.

**NL**

Vóór het bouwen zou men de gietstukken en de handleiding moeten bestuderen. Indien onverhoopt een onderdeel aan het bouwpakket ontbreekt, gelieve men het ontbrekende deel in de handleiding aan te kruisen en deze te zenden aan Gebr. FALLER GmbH, kundendienst@faller.de, Kreuzstraße 9, D-78148 Gütenbach. U ontvangt dan omgaand en gratis het ontbrekende onderdeel. Het kan voorkomen dat u bij bepaalde bouwdozen onderdelen overhoudt.

Für den Zusammenbau des Modells empfehlen wir folgende FALLER-Artikel (sind nicht im Bausatz enthalten):  
For the assembly of the kit we recommend following FALLER products (not included in the kit):  
Pour l'assemblage du modèle, nous vous recommandons les articles FALLER suivants (non inclus dans le kit):  
Om dit model te bouwen adviseren wij de volgende FALLER producten (maken geen deel uit van deze bouwset):



Art. Nr. 170492  
FALLER-EXPERT

Flüssigkleber in Plastikflasche mit Spezialkanüle für feinste Klebstoffdosierung.

Liquid cement in plastic bottle with canule for very fine dosage.

Cette liquide en bouteille plastique avec bec verseur pour un dosage précis.

Vloeibare lijm in plastic-flescom met doseerbuisje om nauwkeurig te lijmen.



Art. Nr. 170688  
SPEZIAL-SETZENSCHNEIDER

zum gerätfreien Abtrennen von feinsten Spritzteilen.  
Nur für Polystyrol geeignet.

Special side cutter for cutting off ultra-fine moulded parts without burrs.  
Only suitable for polystyrene.

Pince coupante spéciale pour couper sans bavure les pièces moulées par injection. Convient uniquement au polystyrène.

Speciale zijknijplang voor het braamloos afsnijpen van de fijnste gietstukdelen. Alleen geschikt voor polystyrol.



ajckids.com  
planes, trains automobiles

Inhalt	Spritzlinge	1	2	3	4	5	6	7	8	9	10	11	12	13	14
Contents	Sprues	1	2	3	4	5	6	7	8	9	10	11	12	13	14
Contenu	Moulages	1	2	3	4	5	6	7	8	9	10	11	12	13	14
Inhoud	Gietstukken	1	2	3	4	5	6	7	8	9	10	11	12	13	14

Sa. Nr. 169 202 0

2

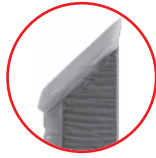
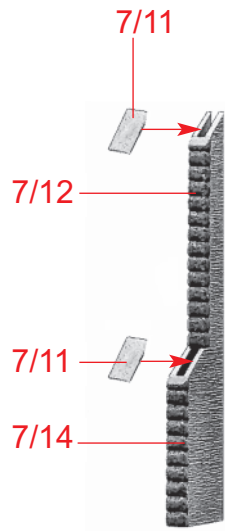
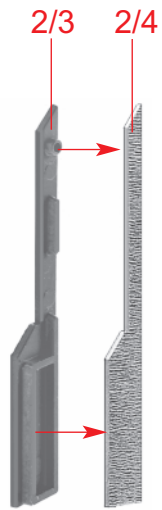

**(A)** 4 x

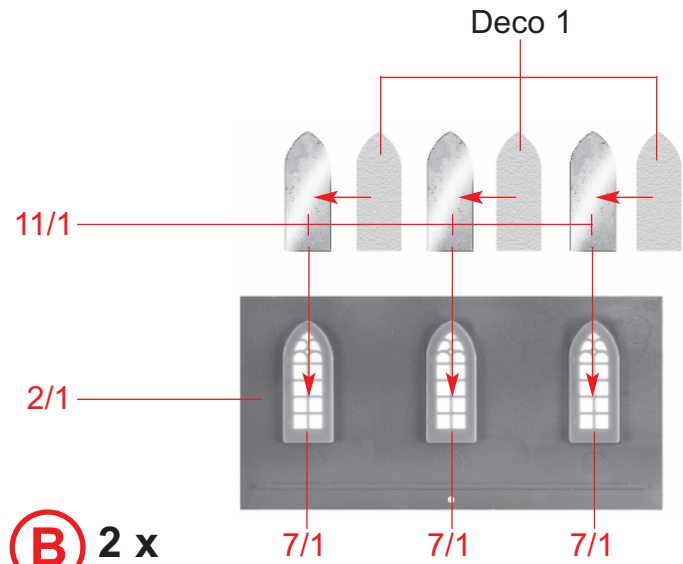

**(B)** 2 x

**(B)**

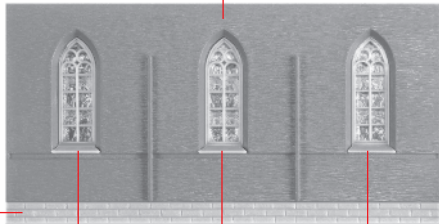

6/6

7/24

7/24

7/24

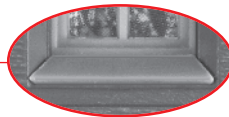

**(C)** 2 x

7/18

7/18

7/18

**(C)**

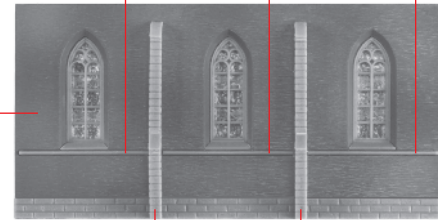

**(A)**

**(A)**

**(D)** 2 x

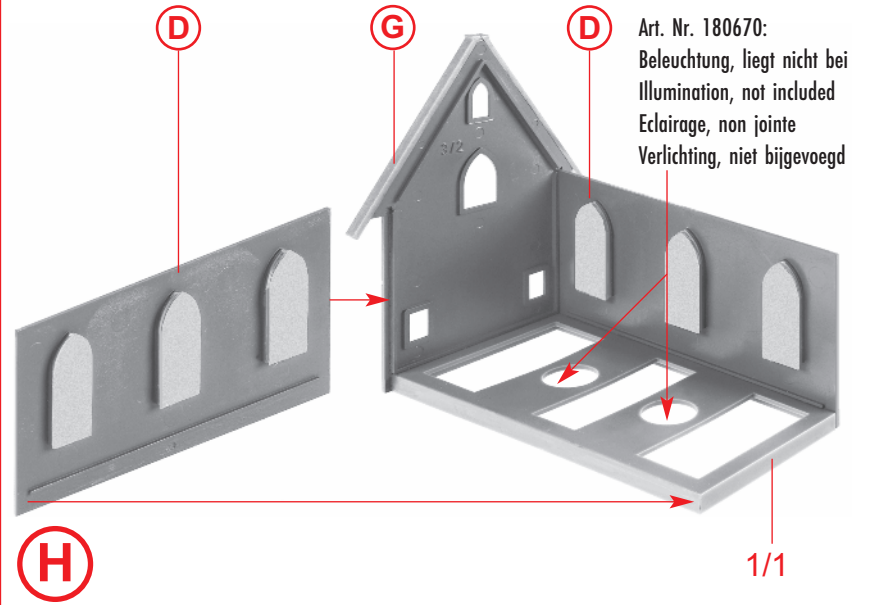
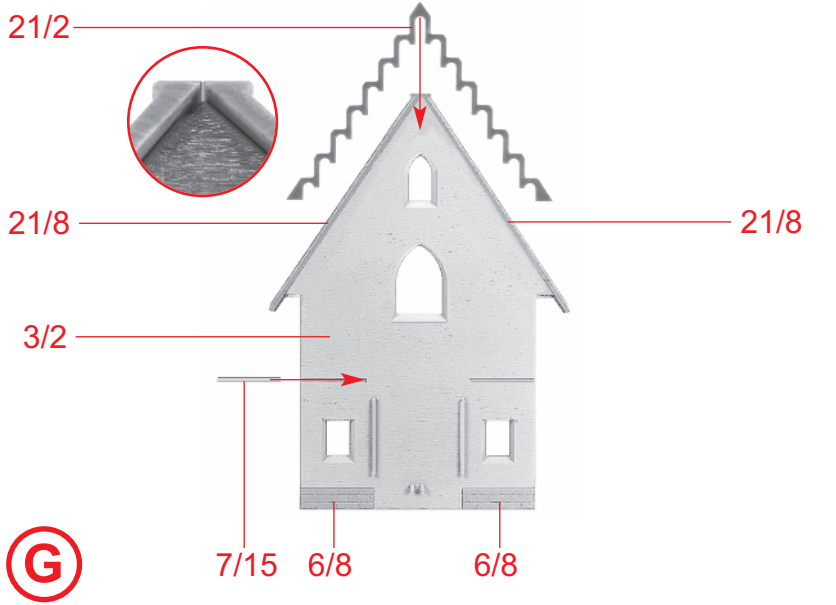
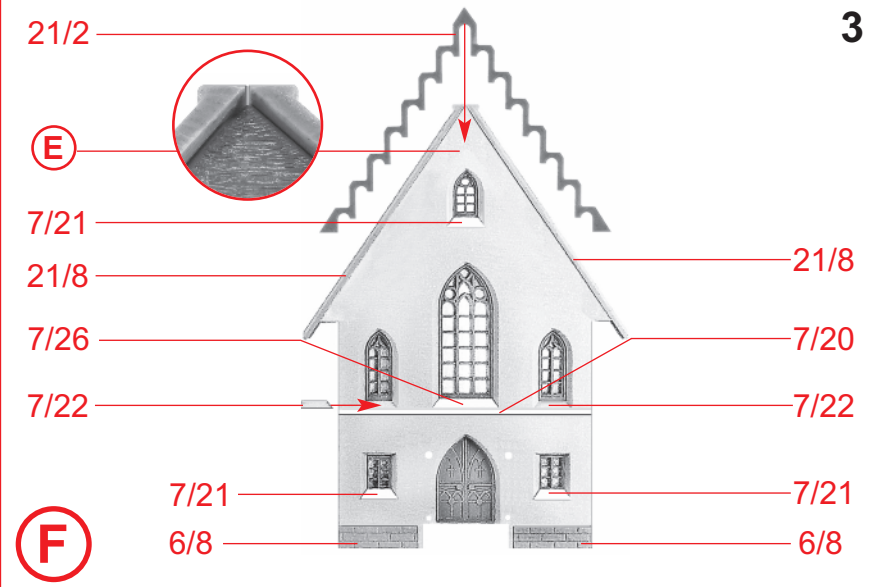
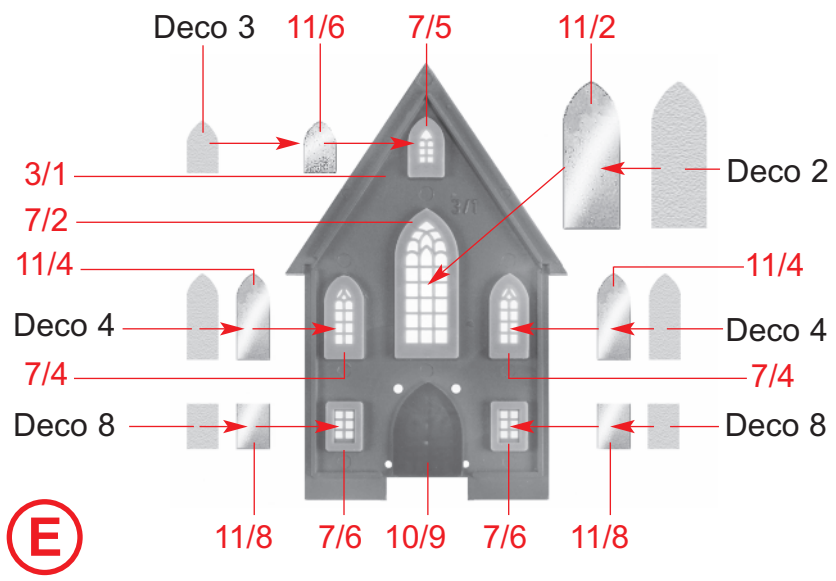

4

6/7

F

Papiermaske  
Papermask  
Masque  
Masker

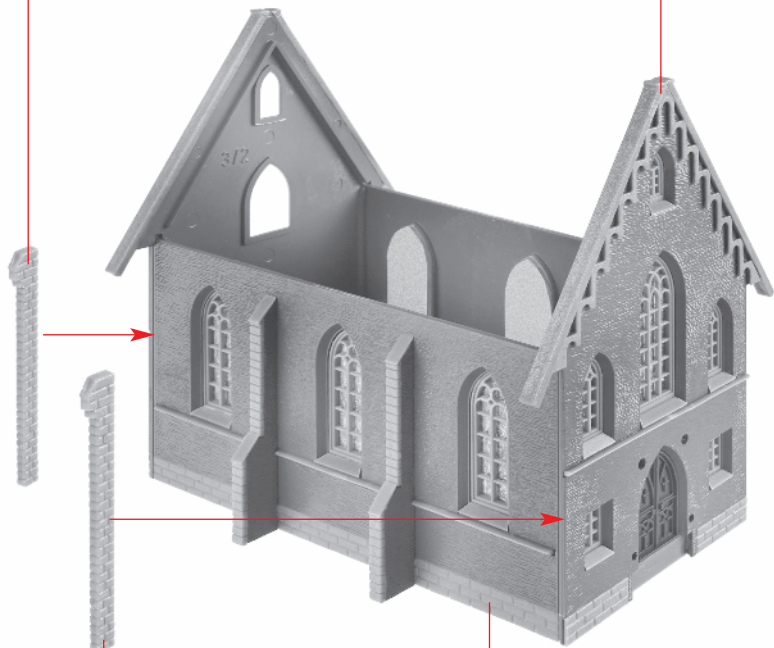

I

6/7

H

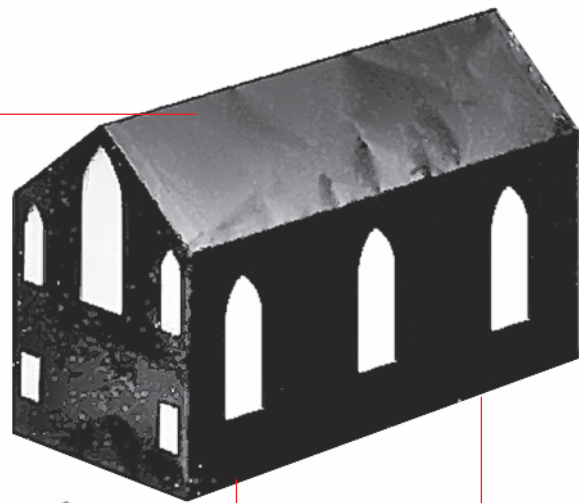

10/13

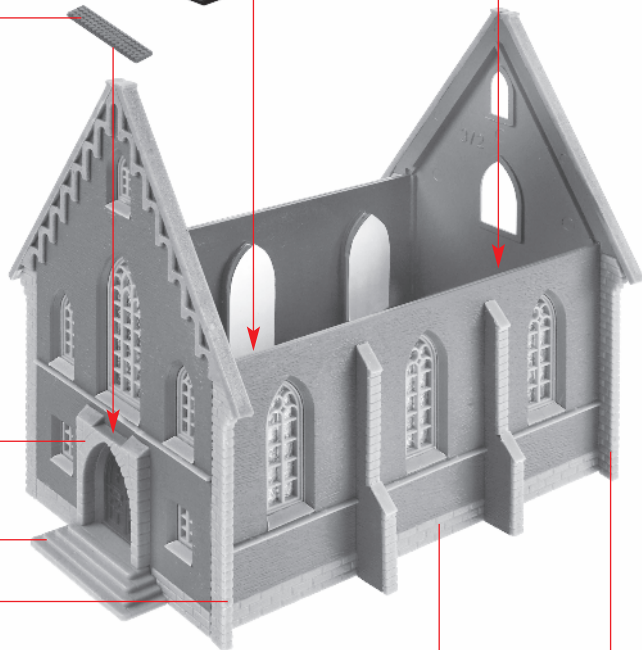

6/1

6/2

6/7

J

I

6/7

5/1



6/12

**K**

11/5 Deco 5

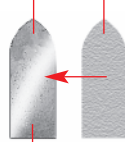

7/7

5/2

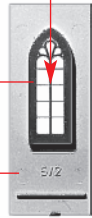

**L** 2 x 7/23 6/14

5/5 5/6



7/13

7/11

7/28



7/14

**M** 4 x

Papiermaske  
Papermask  
Masque  
Masker

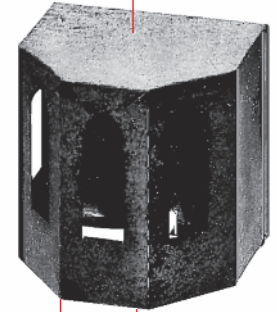

11/5 Deco 5

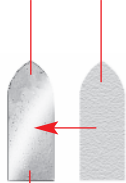

7/7

5/3

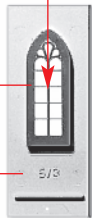

6/15 7/23

**N**

11/5 Deco 5

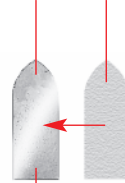

7/7

5/1

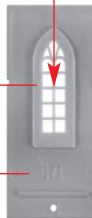

**O** 6/12 7/23

**K** 1/3 **L** **N** **L**

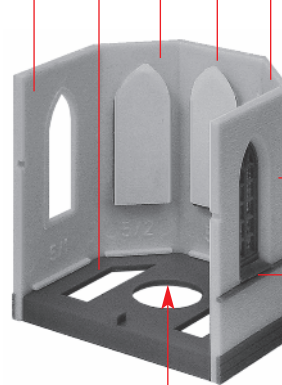

7/17

**P** Art. Nr. 180670:  
Beleuchtung, liegt nicht bei  
Illumination, not included  
Eclairage, non jointe  
Verlichting, niet bijgevoegd

**P**

**M**

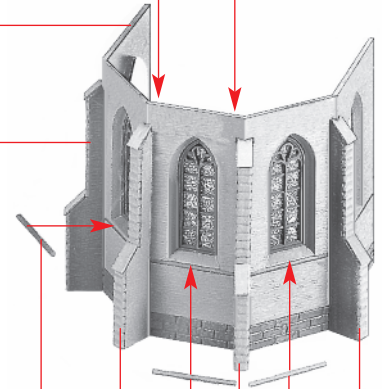

**M**

**Q**

7/16

**M**

7/16

7/16

**M**

6

**(R)** 6 x

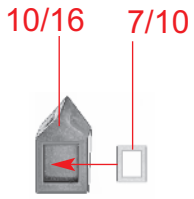

7/8

8/1

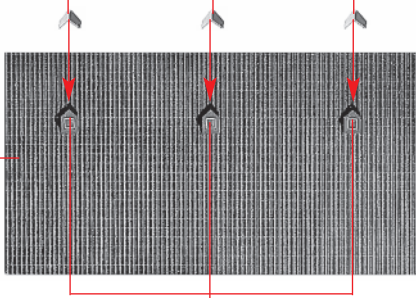

**(S)** 2 x

**(R)**

**(S)**

8/3

8/3

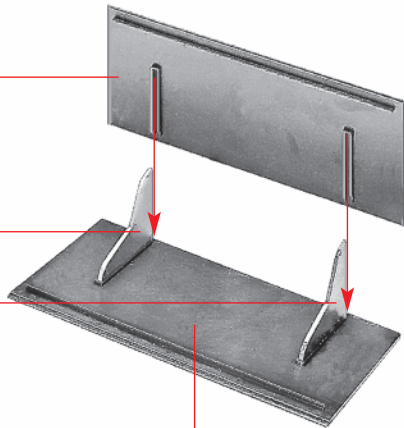

**(T)**

**(S)**

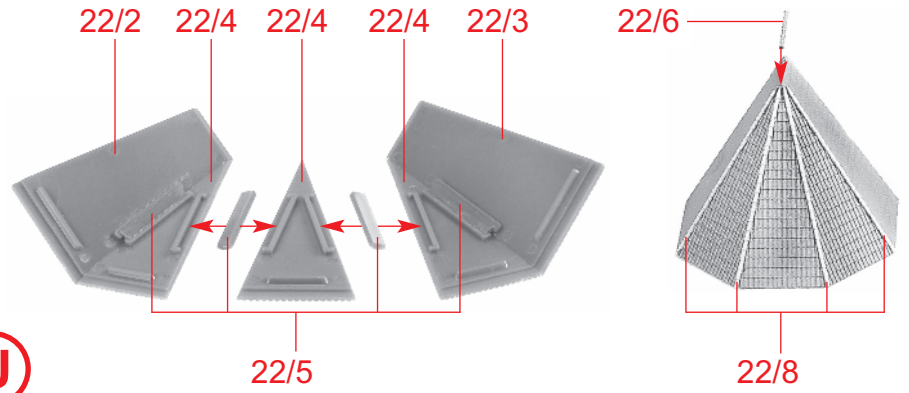

**(U)**

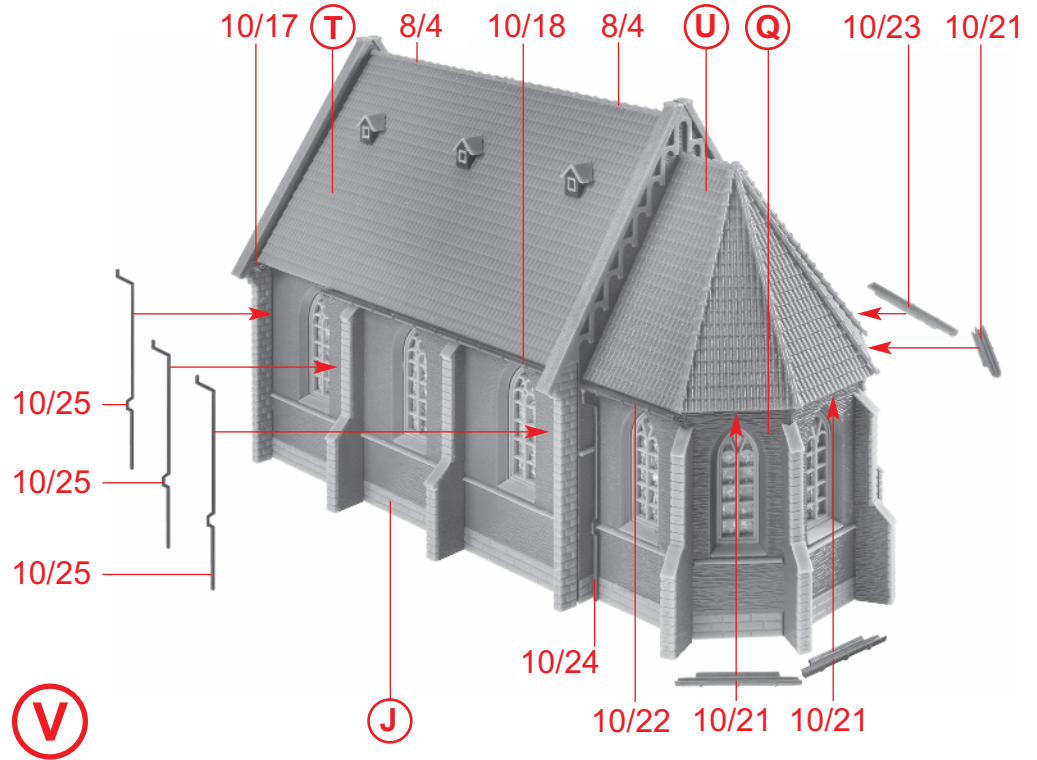

## Wichtige Hinweise zur Anleitung

Die Kirche kann sowohl mit Zwiebelturm als auch mit Spitzturm gebaut werden. Entscheiden Sie sich bitte vor der Montage des Turmes über die gewünschte Version.

Beim Bau mit Zwiebelturm richten Sie sich bitte nach Pos. A-F, beim Bau mit Spitzturm nach Pos. p-v.

Beide Turmarten lassen sich mit Spitzen (10/27 + 10/31) oder Kreuzen (10/15) verzieren. Für den Apsisturm sind dies die Teile 10/14 oder 10/26. Beim Bau mit Zwiebeltürmen wird das montierte Türmchen Pos. I auf das Dach der Apsis (Chor) geklebt.

## Important information

This church can be built with onion towers or spires. You must make the decision before you start assembling the towers. For an onion tower follow figs. A-F, for a spire follow figs. p-v. Both kinds can be topped with either points (10/27 + 10/31) or crosses (10/15).

For the turret above the choir use parts 10/14 or 10/26.

When assembled glue it onto the roof of the choir (fig. I).

## Conseil important

L'église peut être équipée de clochers d'un toit à bulbe ou d'un toit pointu.

Le choix doit être fait avant le montage des tours. Veuillez vous reporter aux figures A-F en cas de toit à bulbe, et aux figures p-v en cas de toit pointu. Les deux toits peuvent être équipés de la pointe (10/27 + 10/31) ou de la croix (10/15). Lors du montage de tour avec le toit à bulbe, la petite tour (en utilisant 10/14 ou 10/26) sera collée sur l'abside (fig. I).

## Belangrijke Aanwijzingen

De kerk kan worden gebouwd met een uivormige koepel of met spits torendak.

Vóór montage van de toren moet u besluiten welke versie u bouwt. Bij de bouw van de uivormige koepel volgt u pos. A-F. Bij de bouw van het spitse torendak pos. p-v. Op beide uitvoeringen kunnen de spitsen (deel 10/27 + 10/31) of de kruizen (deel 10/15) worden aangebracht. De delen 10/14 of 10/26 passen op het torentje van de apsis. Bij de bouw met uivormige koepels wordt het gemonteerde torentje pos. I op het dak van de apsis gelijmd.

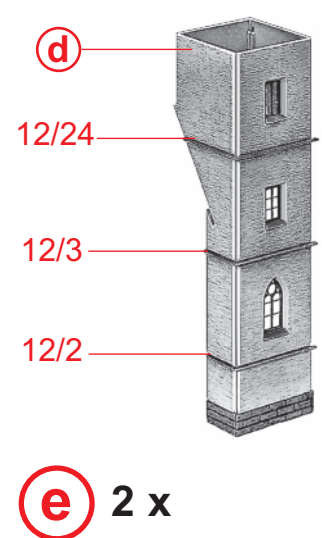
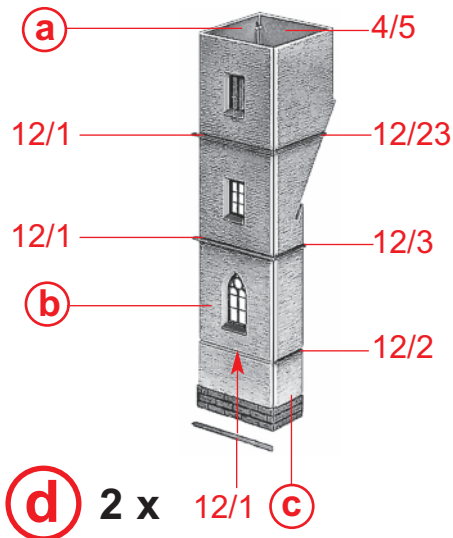
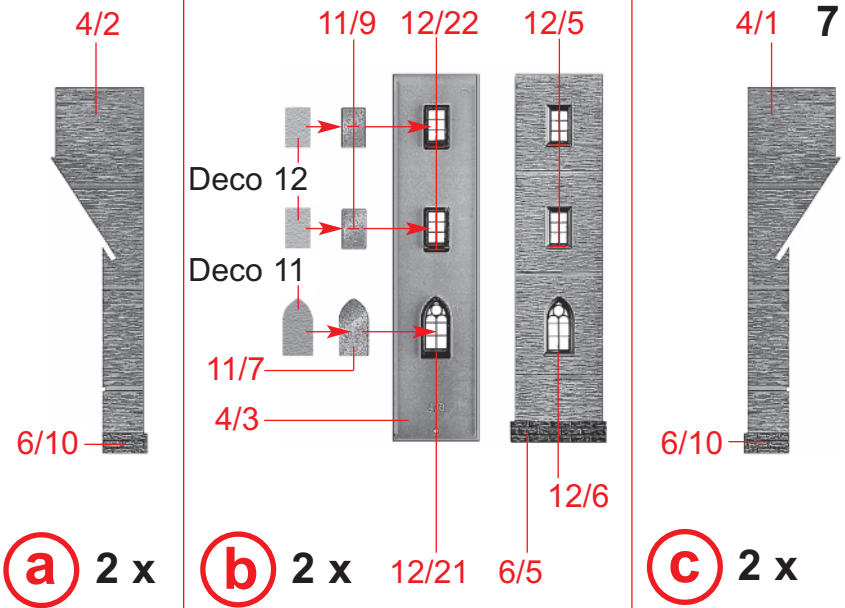

8

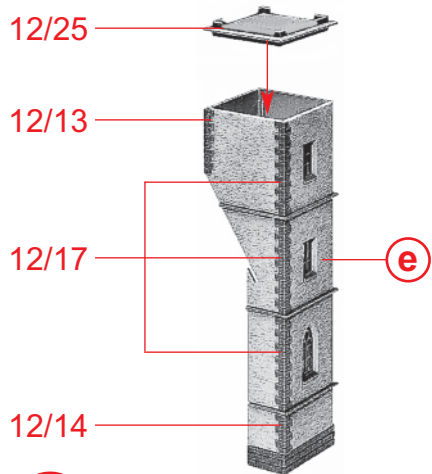

**f** 2 x

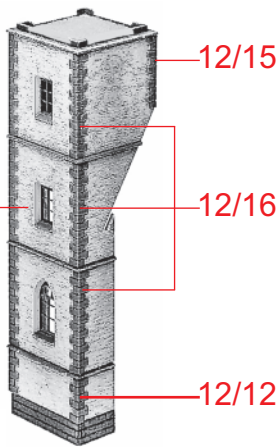

**g** 2 x

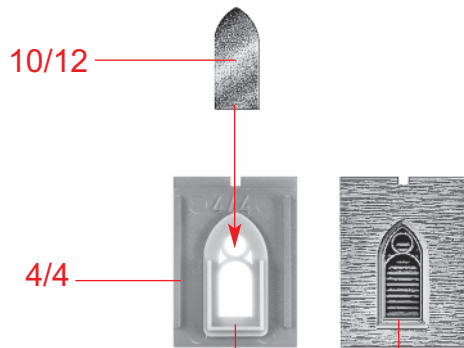

**h** 8 x 12/20 12/4

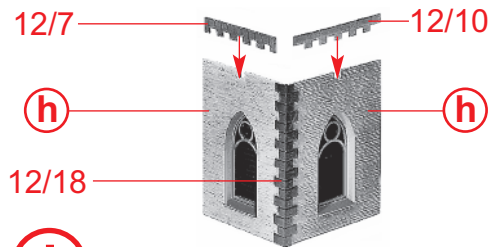

**i** 4 x

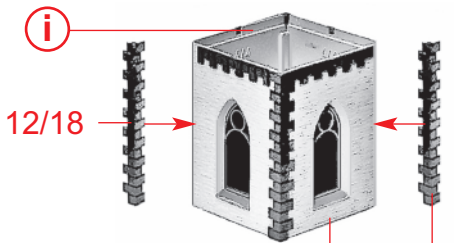

**j** 2 x 12/18

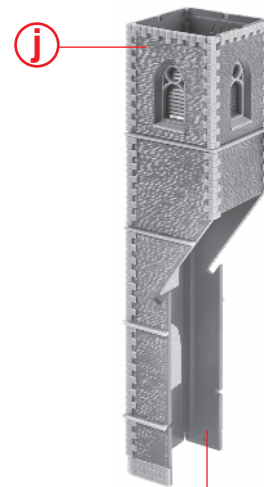

**k** 2 x g

Loch mit Teil 6/11 durchdrücken.  
Pierce hole with the help of part 6/11.  
Percer la trou à l'aide de 6/11.  
Opening met hulp van deel 6/11 doorsteken.

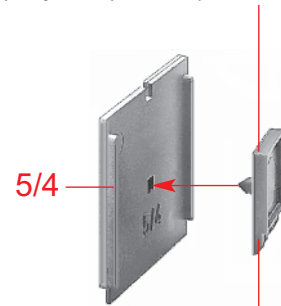

**l** 6 x 6/11

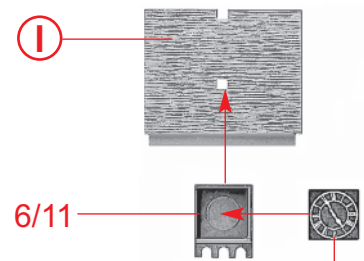

**m** 6 x Deco 10

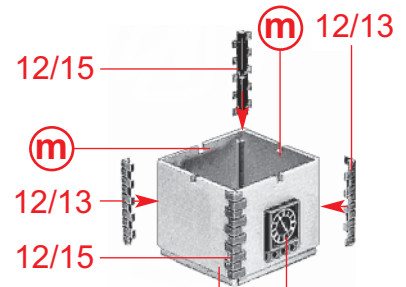

**n** 2 x 5/4 m

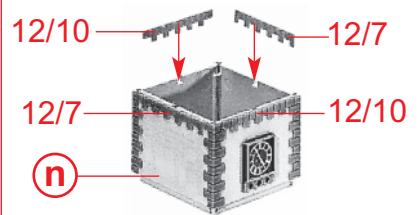

**o** 2 x



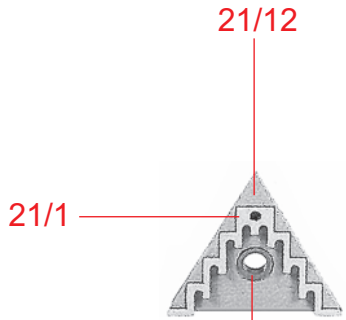

**(p)** 8 x 21/11

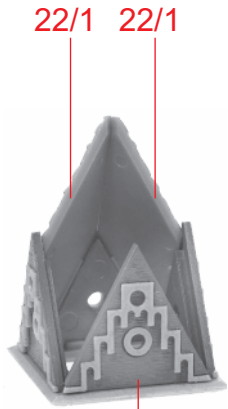

**(r)** 2 x (q)

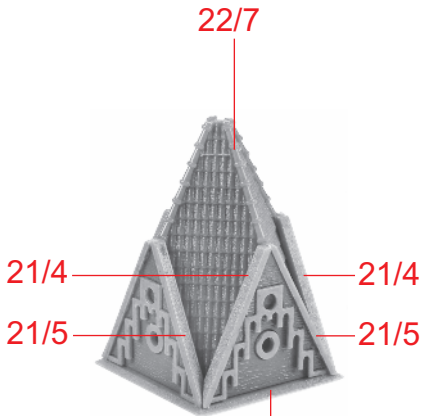

**(t)** 2 x (s)

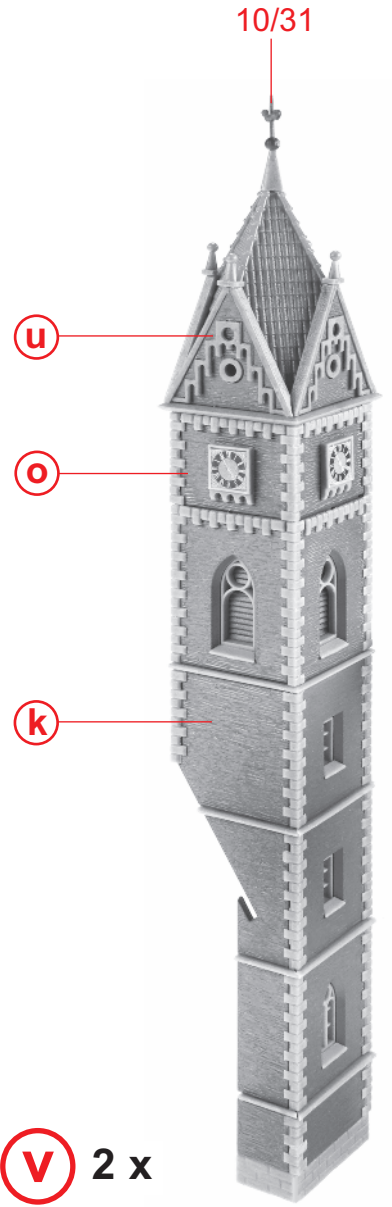

(u)  
(o)  
(k)  
**(v)** 2 x

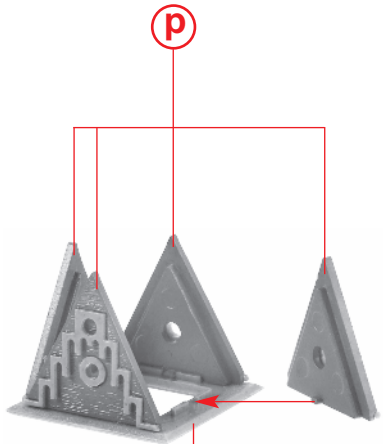

**(q)** 2 x 21/3

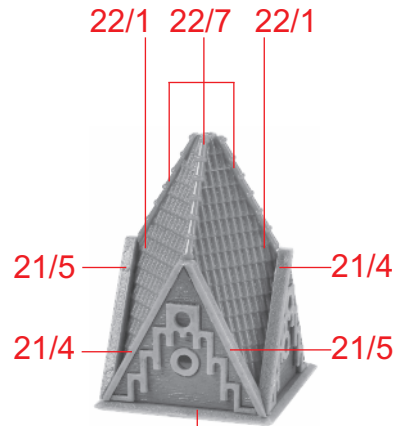

**(s)** 2 x (r)

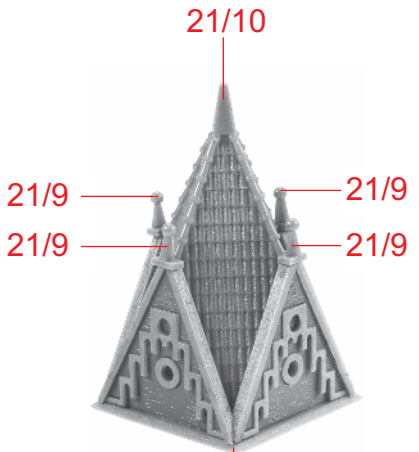

**(u)** 2 x (t)

**10 Variante 10/1**



**(A) 2 x**

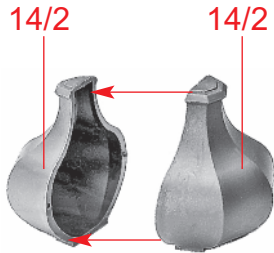

**(B) 2 x**

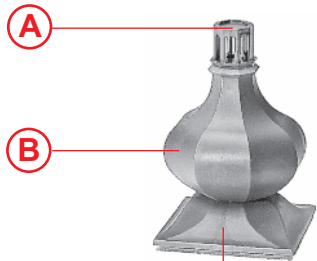

**(C) 2 x 14/1**

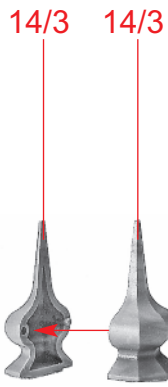

**(D) 2 x**

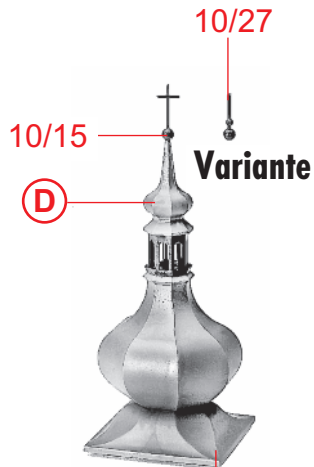

**(E) 2 x (C)**

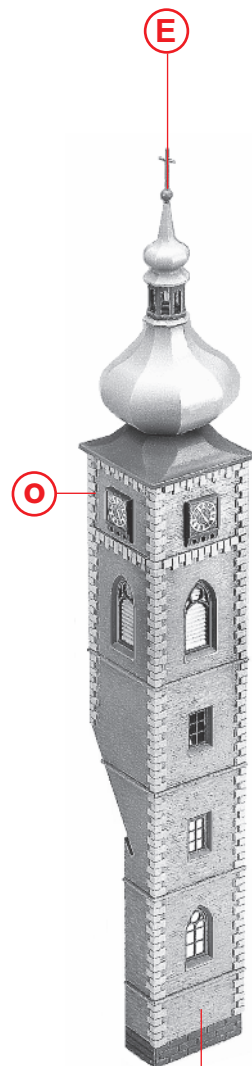

**(F) 2 x (k)**

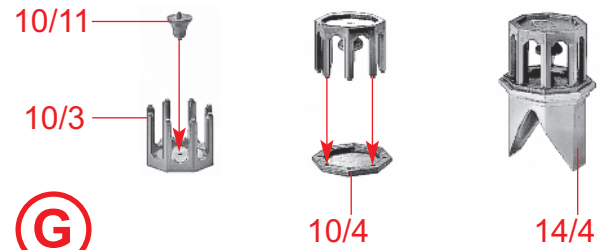

**(G)**

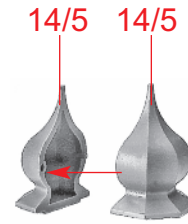

**(H)**

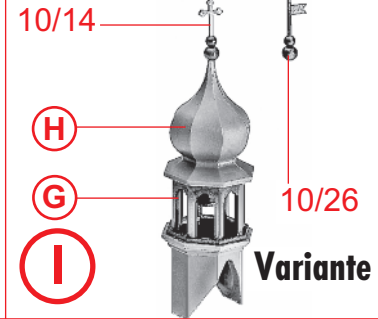

**(I)**

**Variante**

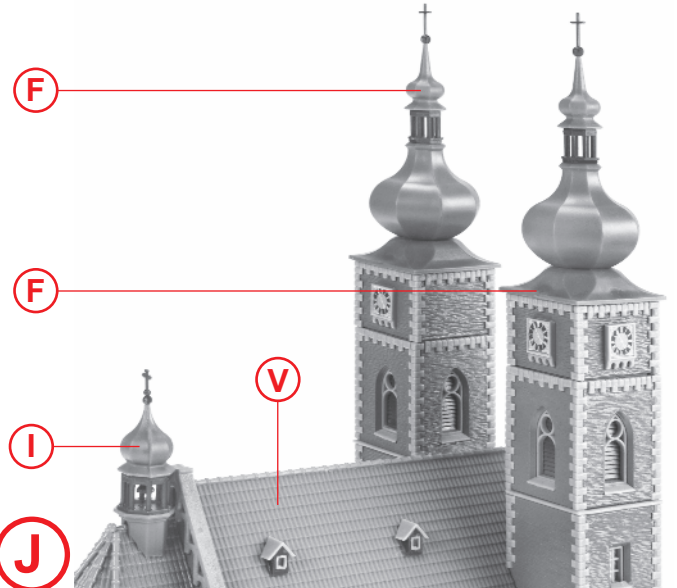

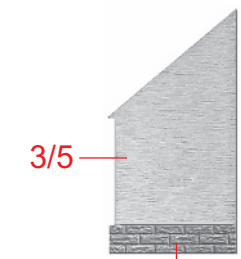

**(K)** 6/9

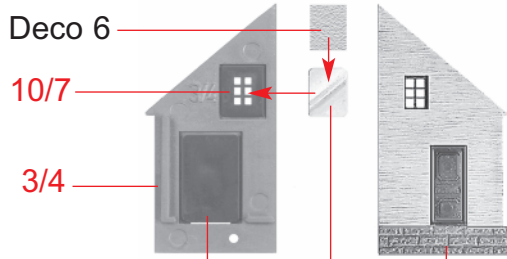

Deco 6  
10/7  
3/4  
**(L)** 10/10 11/10 6/9

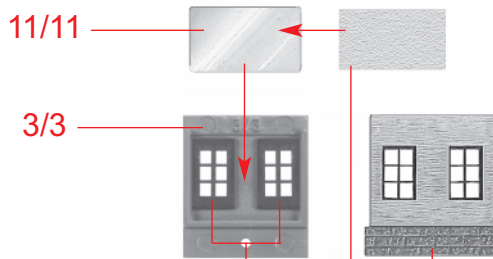

11/11  
3/3  
**(M)** 10/5 Deco 7 6/4

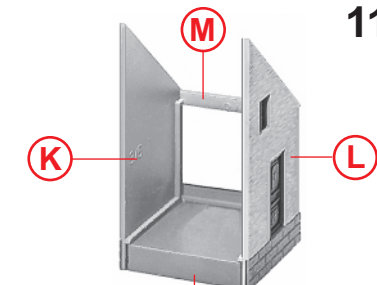

**(N)** 1/4

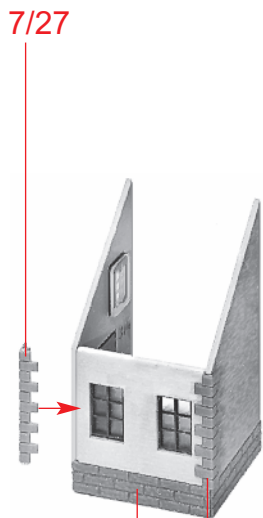

7/27  
**(O)** **(N)** 7/27

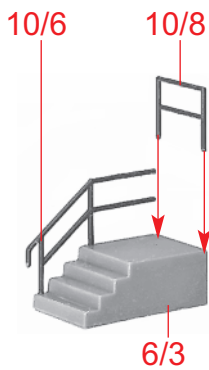

10/6 10/8  
**(P)** 6/3

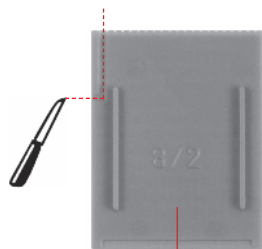

**(Q)** 8/2

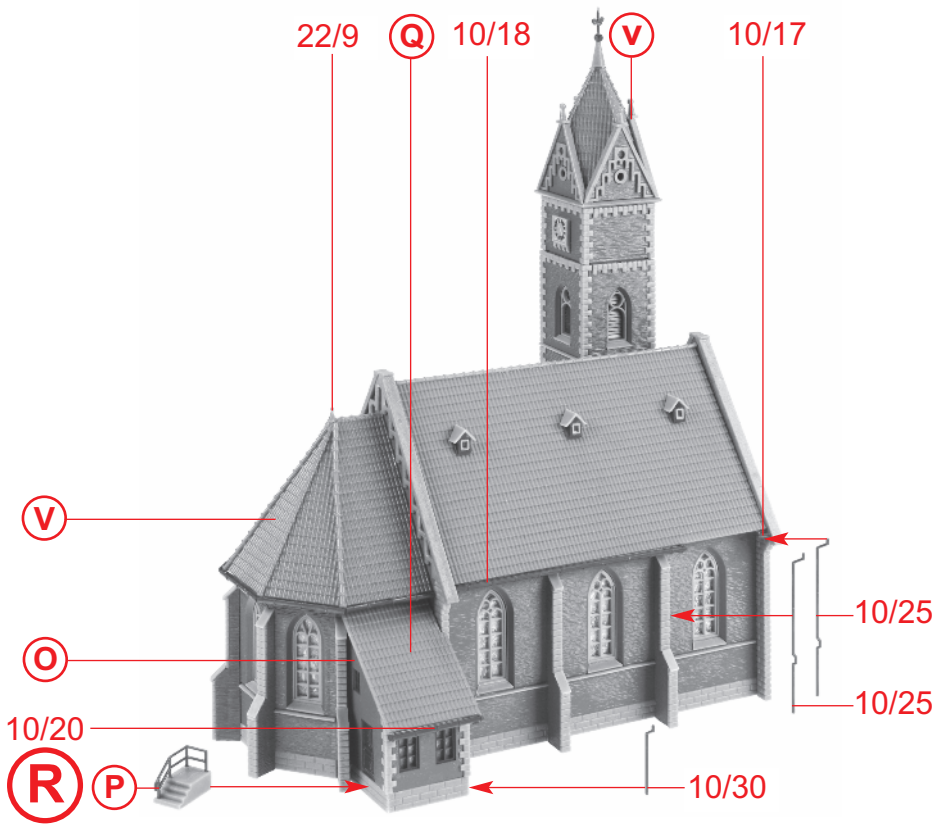

22/9 **(Q)** 10/18 **(V)** 10/17  
**(V)** 10/25 10/25  
10/20 **(R)** **(P)** 10/30

12

Deco 9



Deco 9

10/28

**S** 2 x

10/27



21/6

**T**

21/7



21/6

**U**

**T**

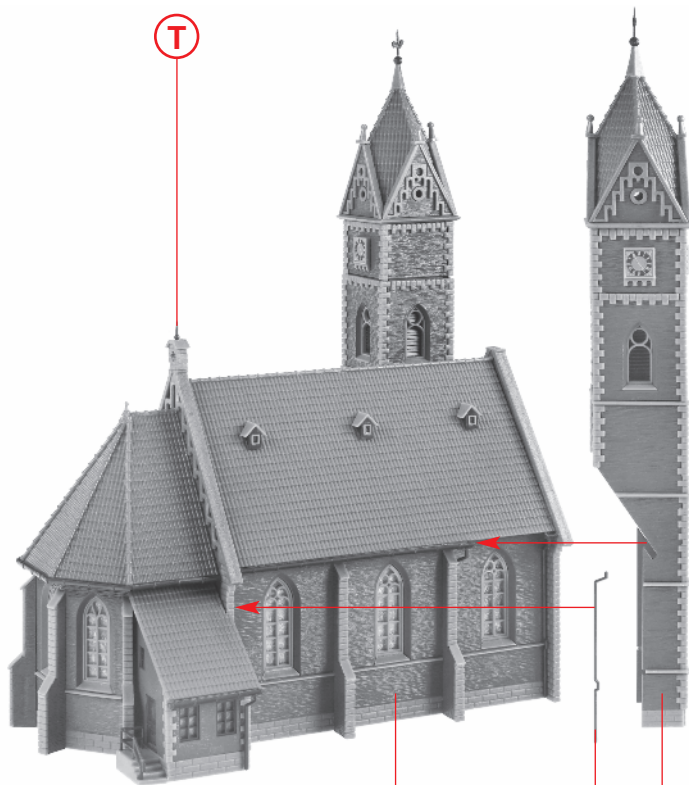

**V**

**R**

10/25

**V**

**W**

**S**

**V**



**U**

**S**

**V**