

POSTAMT

POST OFFICE

BUREAU DE POSTE

POSTKANTOOR



Art. Nr. 130933

D

Vor Beginn des Bastelns sollten Sie sich mit den Spritzlingen und der Anleitung vertraut machen. Sollte es einmal vorkommen, dass ein Teil im Bausatz fehlt, kreuzen Sie bitte das fehlende Teil in der Anleitung an und schicken Sie diese bitte an Fa. Gebr. FALLER GmbH, Abt. Kundendienst, kundendienst@faller.de, Kreuzstraße 9, 78148 Gütenbach. Sie erhalten dann umgehend Ersatz. Es kann vorkommen, dass bei einem Bausatz Einzelteile übrig sind.

GB

Before beginning with the assembly please familiarize yourself with the parts and read the instructions carefully. In case of missing parts please indicate these on the instructions leaflet with a circle and return the leaflet to Gebr. FALLER GmbH, kundendienst@faller.de, Kreuzstraße 9, D-78148 Gütenbach, Germany. You will receive the replacement by return. It may happen in a kit that some parts are not required.

F

Avant de commencer le montage de votre maquette bien lire la notice et repérer les grappes. Si une pièce manque dans une boîte, cochez la pièce correspondante sur la notice et renvoyez-la-nous à Gebr. FALLER GmbH, kundendienst@faller.de, Kreuzstraße 9, D-78148 Gütenbach (R.F.A.). Nous vous ferons parvenir la pièce par retour. Dans certains kits, il est possible que certaines pièces ne soient pas utilisées.

NL

Vóór het bouwen zou men de gietstukken en de handleiding moeten bestuderen. Indien onverhoopt een onderdeel aan het bouwpakket ontbreekt, gelieve men het ontbrekende deel in de handleiding aan te kruisen en deze te zenden aan Gebr. FALLER GmbH, kundendienst@faller.de, Kreuzstraße 9, D-78148 Gütenbach. U ontvangt dan omgaand en gratis het ontbrekende onderdeel. Het kan voorkomen dat u bij bepaalde bouwdozen onderdelen overhoudt.

Für den Zusammenbau des Modells empfehlen wir folgende FALLER-Artikel (sind nicht im Bausatz enthalten):

For the assembly of the kit we recommend following FALLER products (not included in the kit):

Pour l'assemblage du modèle, nous vous recommandons les articles FALLER suivants (non inclus dans le kit):

Om dit model te bouwen adviseren wij de volgende FALLER producten (maken geen deel uit van deze bouwset):



Art. Nr. 170492
FALLER-EXPERT

Flüssigkleber in Plastikflasche mit Spezialkanüle für feinste Klebstoffdosierung.

Liquid cement in plastic bottle with canule for very fine dosage.

Cette liquide en bouteille plastique avec bec verseur pour un dosage précis.

Vloeibare lijm in plastic-flescon met doseerbuisje om nauwkeurig te lijmen.



Art. Nr. 170688
SPEZIAL SEITENSCHNEIDER

zum gratfreien Abtrennen von einsten Spritzteilen.
Nur für Polystyrol geeignet.

Special side cutter for cutting off ultra-fine moulded parts without burrs. Only suitable for polystyrene.

Pince coupants spéciale pour couper sans bavure les pièces miniatures moulées par injection. Convient uniquement au polystyrène.

Speciale zijknijplang voor het braamloos afknippen van de fijste gietstukdelen. Alleen geschikt voor polystyrol.

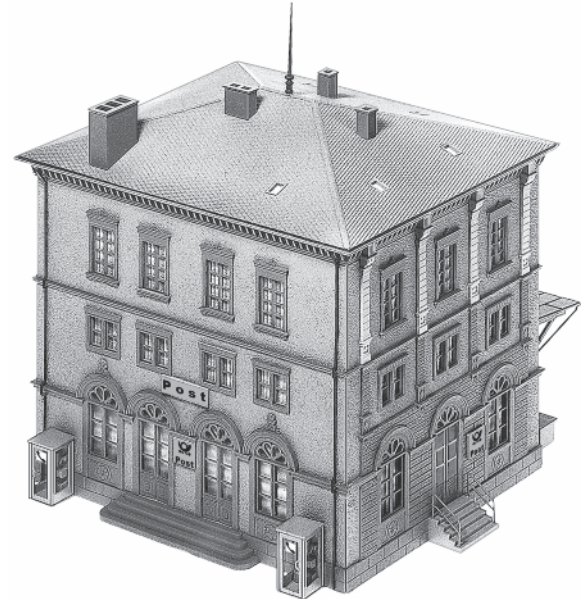

Inhalt	Spritzlinge	1	1	x	3	1	x	8	1	x	16	1	x	27	1	x
Contents	Sprues	2	1	x	4	1	x	12	3	x	25	1	x	3151	1	x
Contenu	Moulages	3	1	x	5	4	x	15	2	x	26	1	x			
Inhoud	Gietstukken															

Sa. Nr. 227 460 0

2

Fensterfolie
Das abgebildete Papier-Musterfenster mit transparentem Klebeband auf die beiliegende Fensterfolie kleben und diese ausschneiden. Fensterfolie vorsichtig mit wenig Klebstoff auf die Rückseite der Fensterrahmen aufkleben.
Window plastic sheet
Using clear adhesive tape fix the pattern window made of paper pictured to the window plastic sheet supplied, and cut that sheet out. Using very little glue, cautiously stick the window sheet to the back of the window frame.
Feuille transparente pour fenêtres
À l'aide de ruban adhésif transparent coller la fenêtre à dessin en papier représentée sur la feuille transparente fournie, et découper cette feuille. Coller avec précaution la feuille transparente, avec très peu de colle, au dos du cadre de la fenêtre.
Raamfolie
De afgebeelde papieren raamdecoratie met transparant plakband op de meegeleverde raamfolie plakken en uitknippen. Raamfolie voorzichtig met een beetje lijm op de achterzijde van de ramen lijmen.

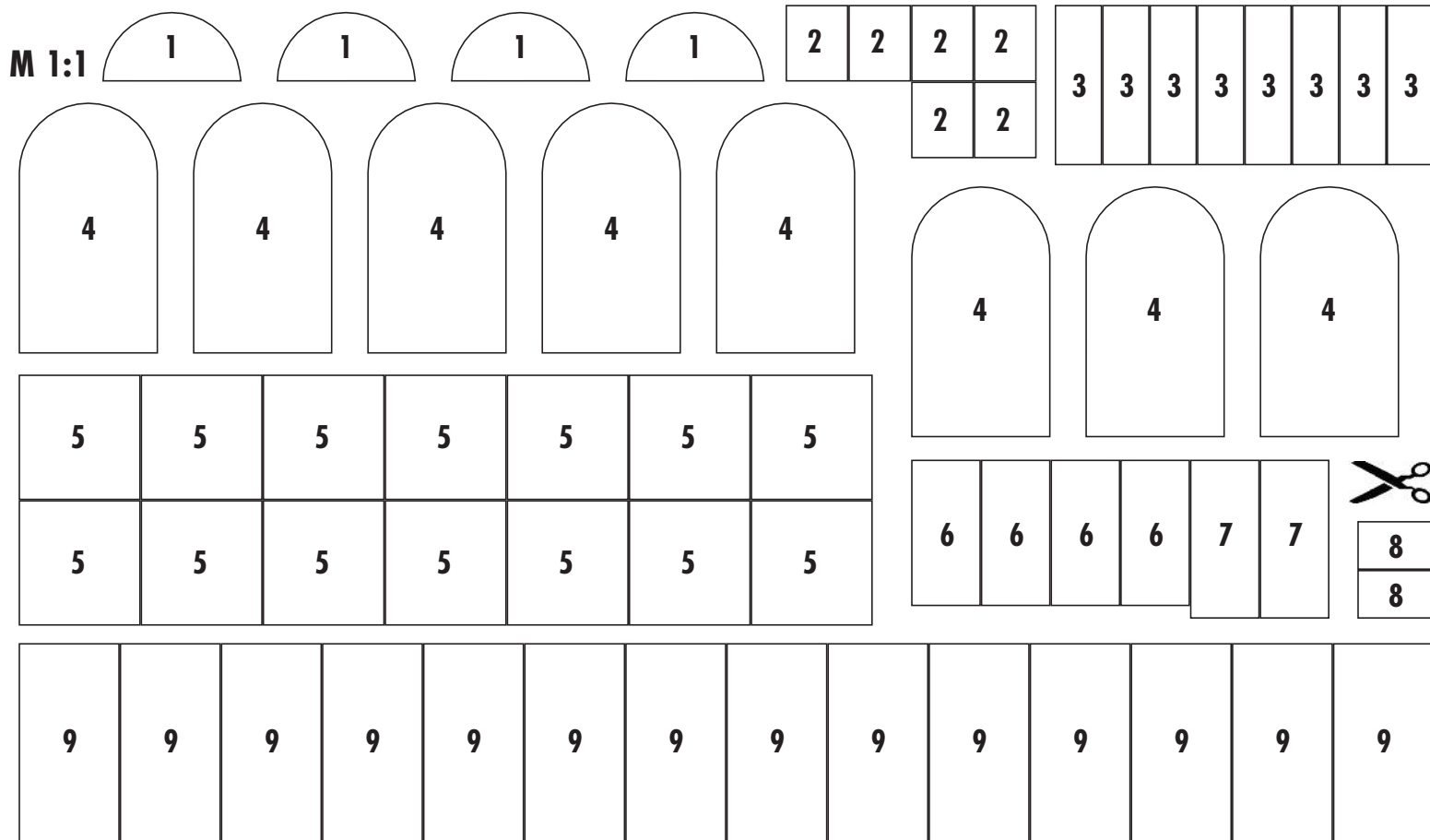

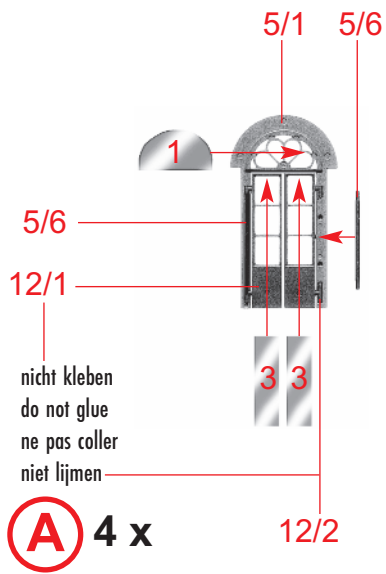

nicht kleben
do not glue
ne pas coller
niet lijmen

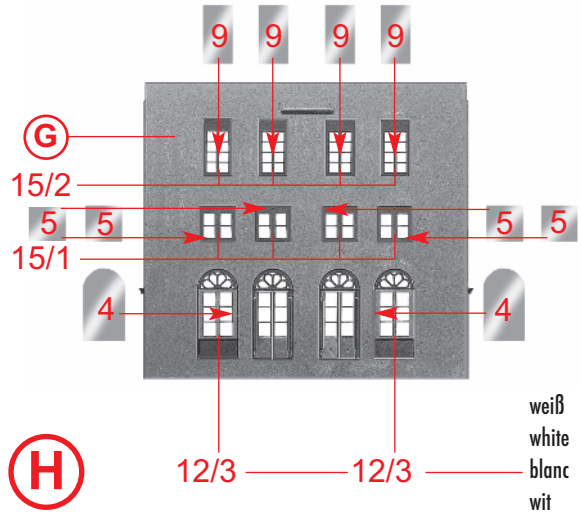
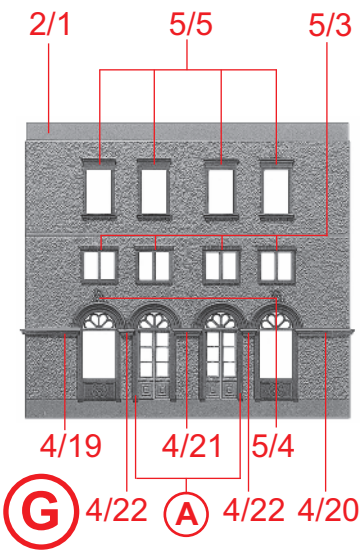
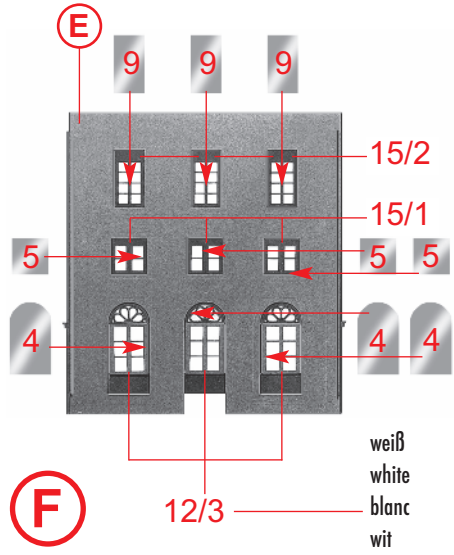
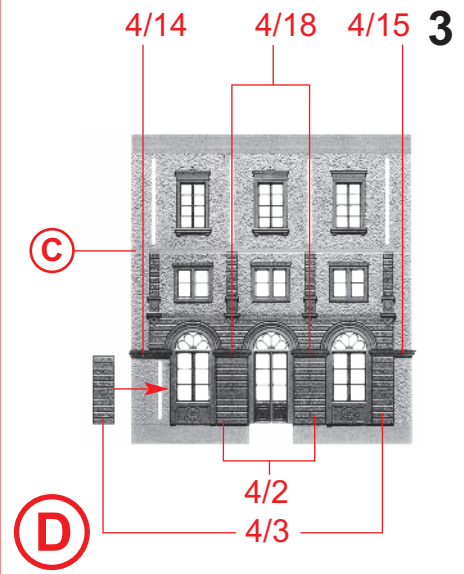
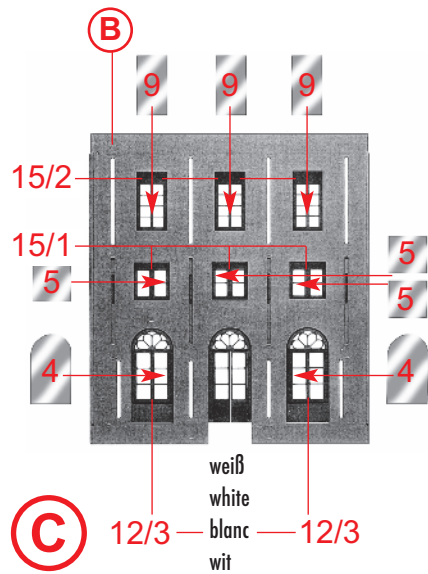
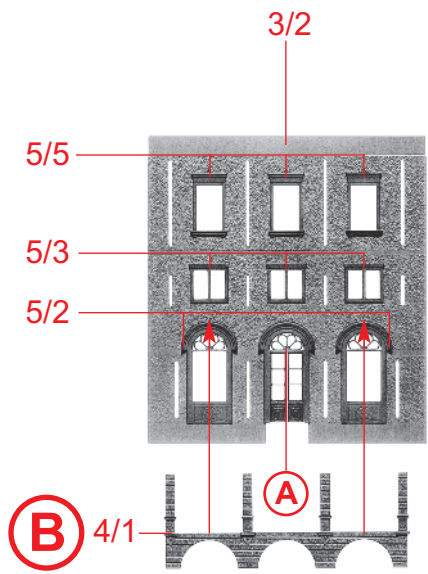

4

25/6

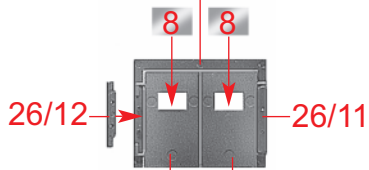

nicht kleben
do not glue
ne pas coller
niet lijmen

I 26/3 26/2

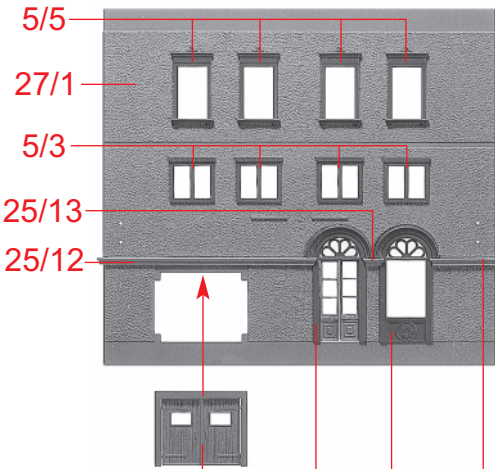

J **I** **A** 5/2 25/14

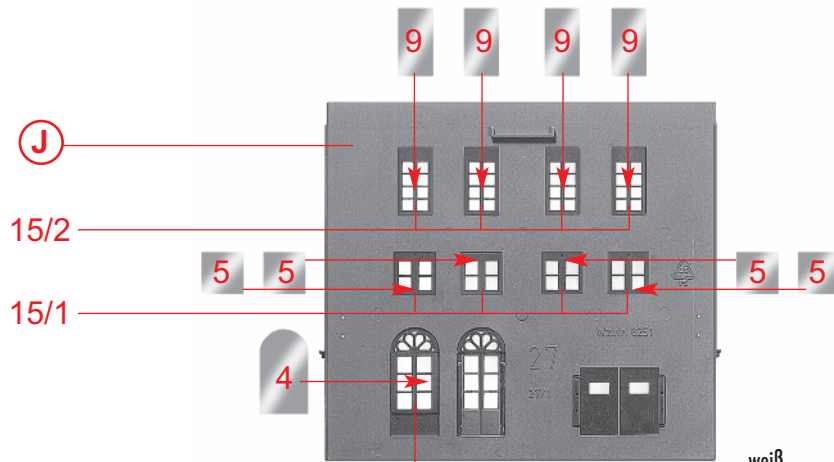

K 12/3
weiß
white
blanc
wit

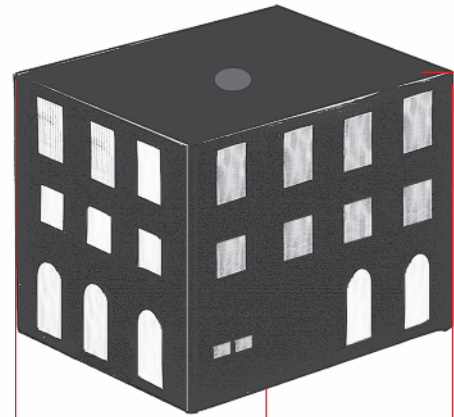

Papiermaske
Papermask
Masque
Masker

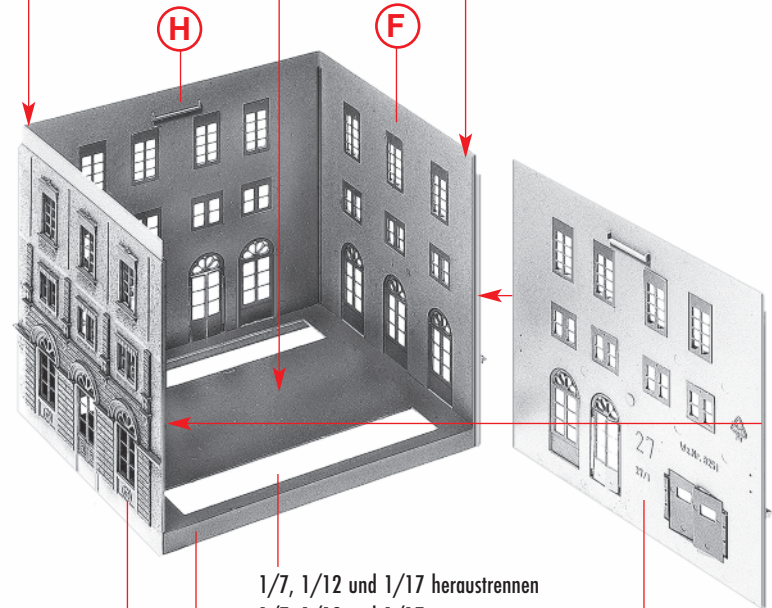

L **D** 1/1
1/7, 1/12 und 1/17 heraustrennen
1/7, 1/12 and 1/17 rip out.
1/7, 1/12 et 1/17 retirer.
1/7, 1/12 een 1/17 eruit nemen.

K

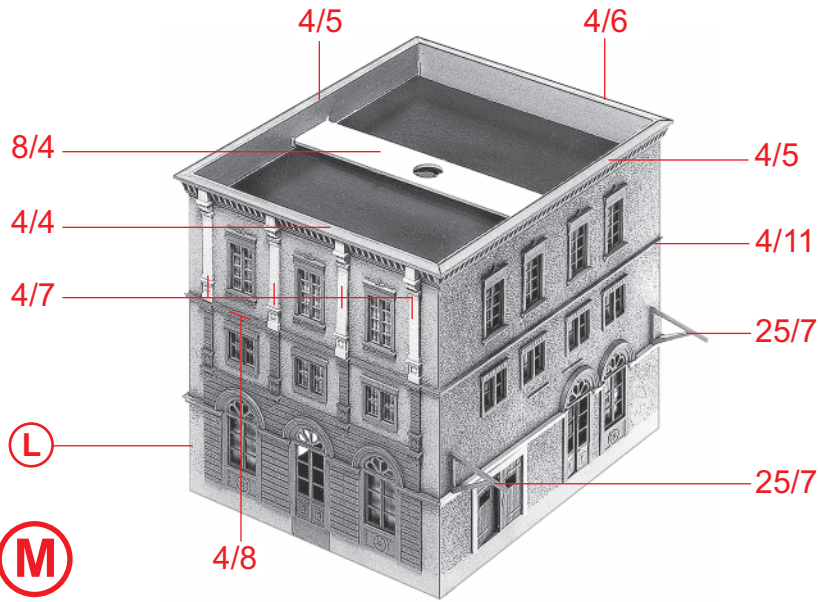

Ⓜ

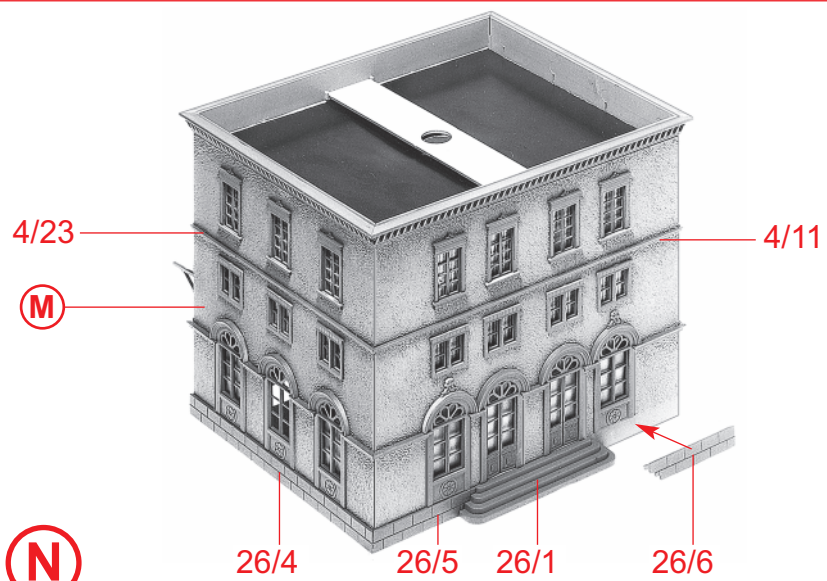

Ⓝ

Art. Nr. 180667:
 Beleuchtung, liegt nicht bei
 Illumination, not included
 Eclairage, non jointe
 Verlichting, niet bijgevoegd

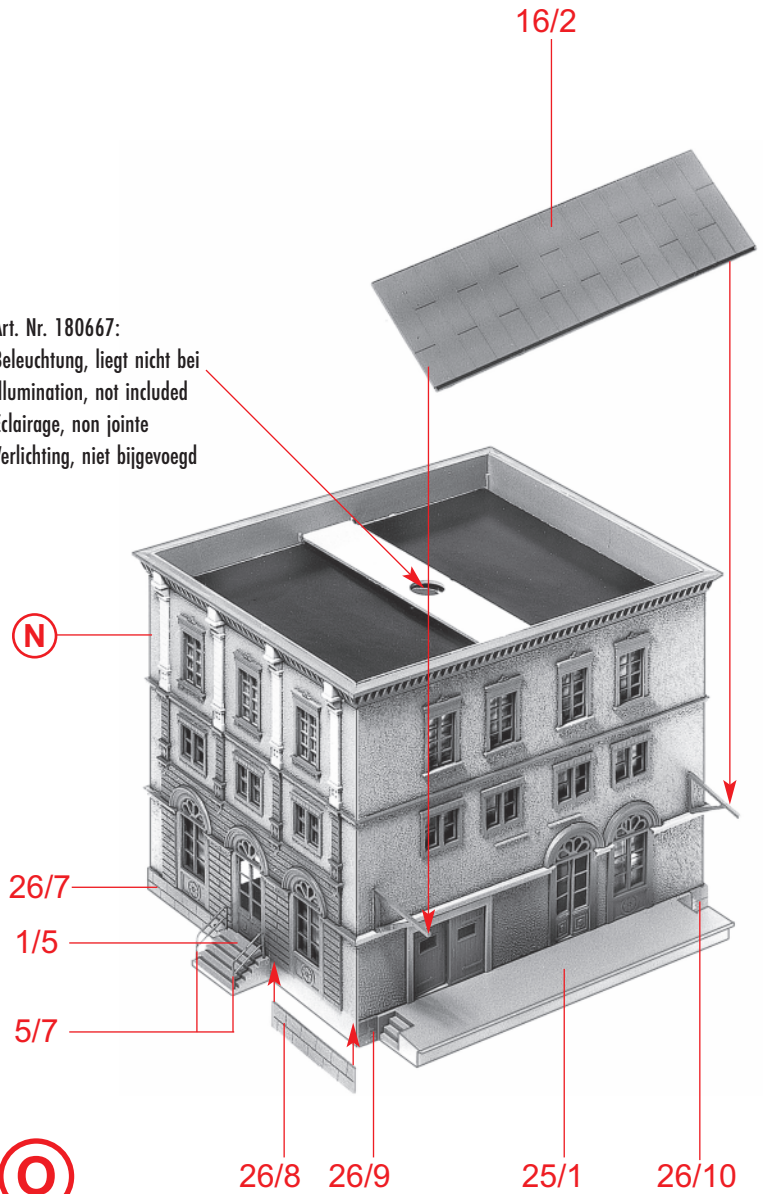

Ⓞ

6

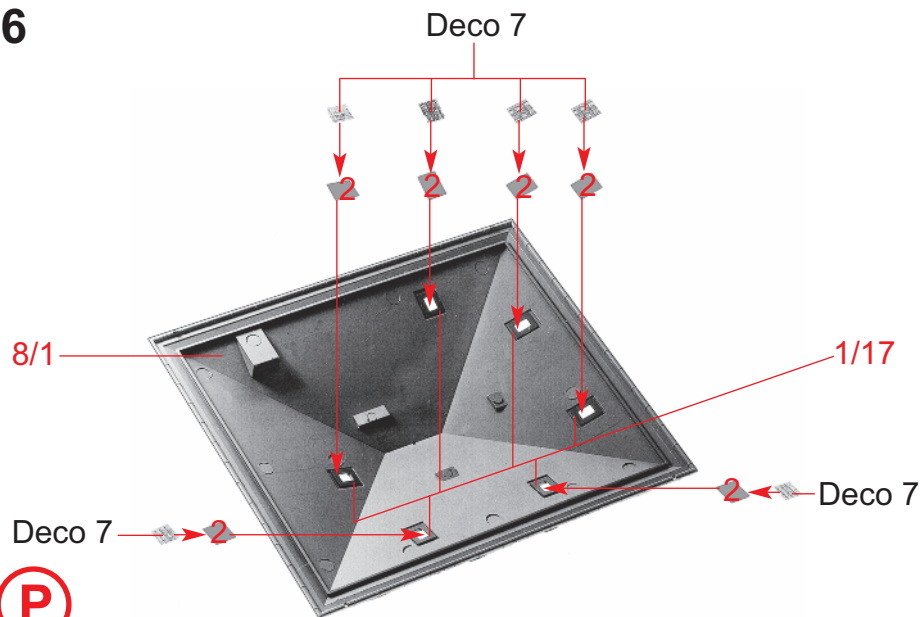

P

O

T

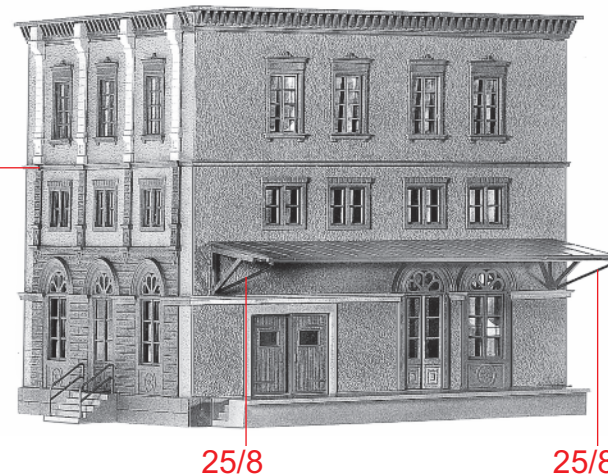

Q

P

T

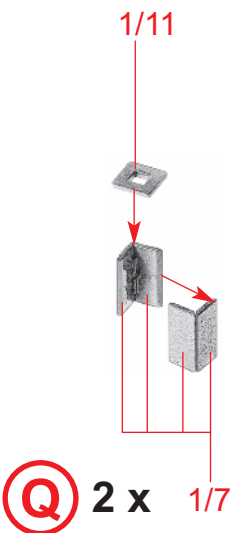
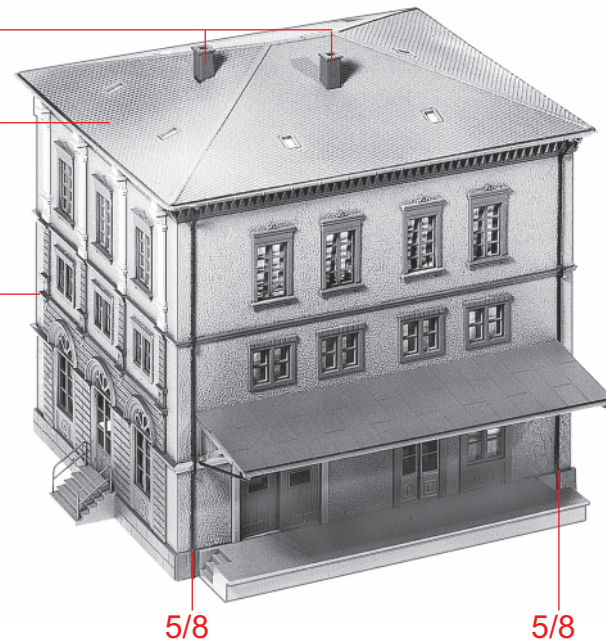

Q

2 x 1/7

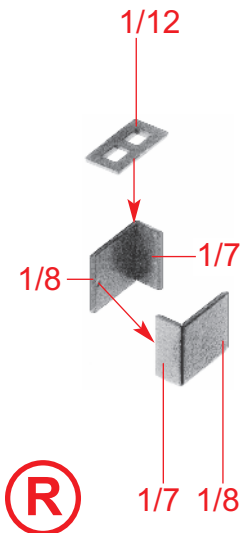

R

1/7 1/8

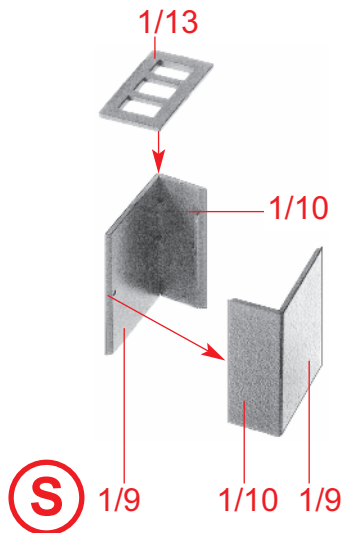

S

1/9 1/10 1/9

U

5/8

5/8

Deco 8



Deco 2



V 2 x

25/4



W

25/5

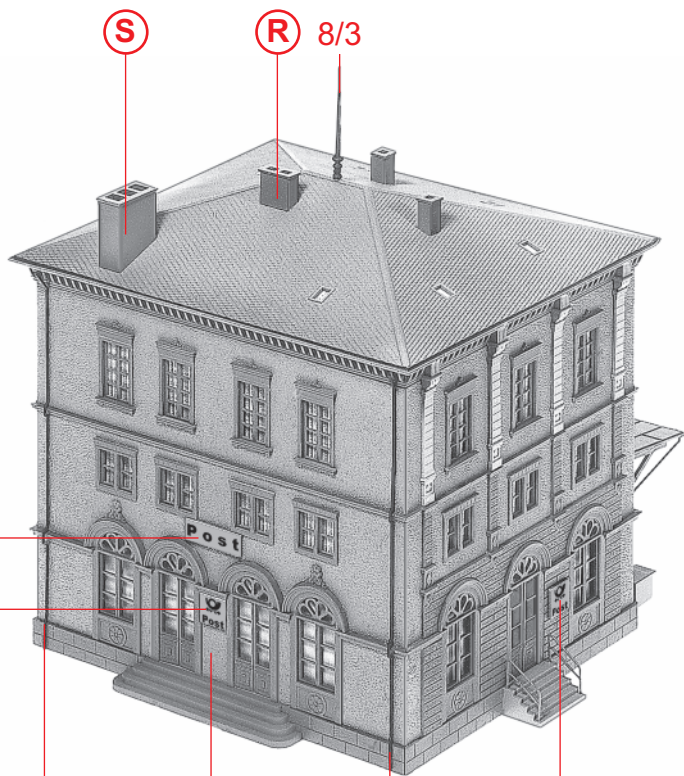

S

R 8/3

W

V

X

5/8

U

5/8

V

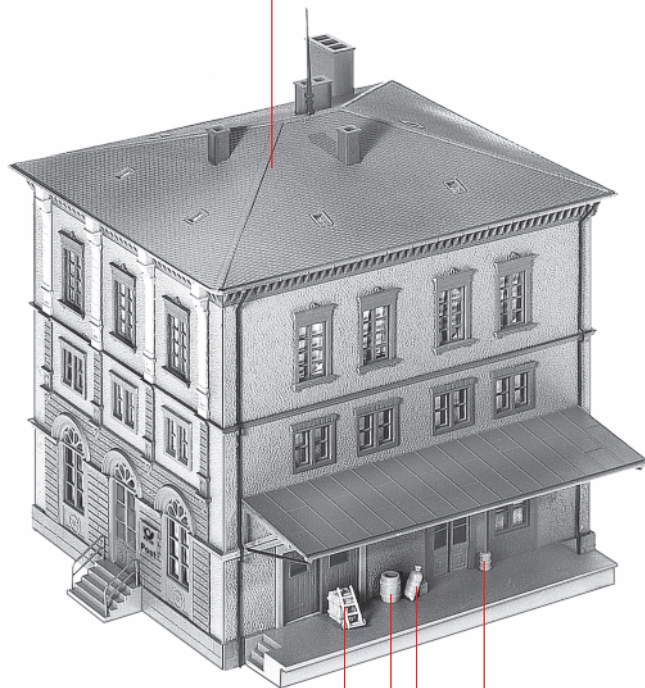

X

Y

Ausschmückungsteile
 Decoration parts
 D'éléments décoratifs
 Decoratiedelen

8

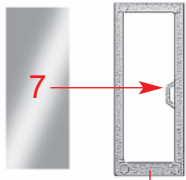

7

3/5

a 2 x

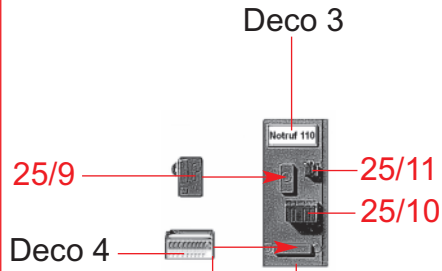

Deco 3

25/9

25/11

25/10

Deco 4

b 2 x 3/2 3/1

Deco 5



3/10

g 4 x

Deco 5



3/11

h 2 x

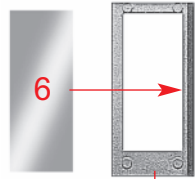

6

3/4

c 2 x

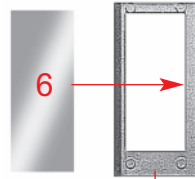

6

3/3

d 2 x

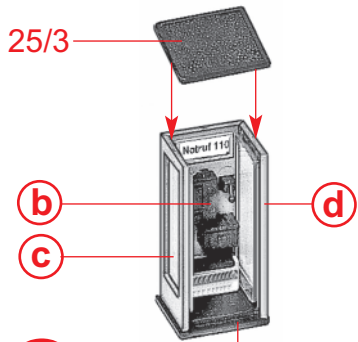

25/3

b

c

d

e 2 x 25/2

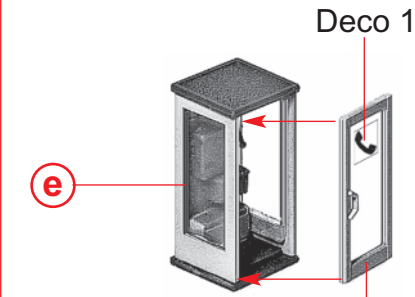

Deco 1

e

a

f 2 x

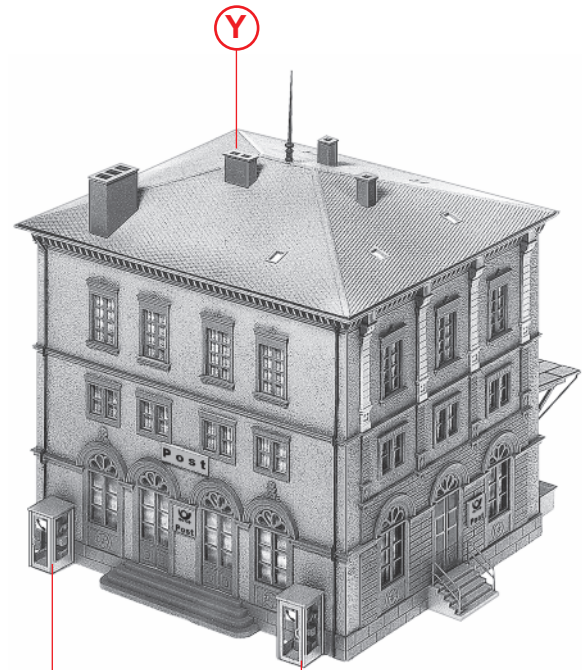

Y

f

f

i