

Fachwerkhaus

Half-timbered house
Maison à pans de bois
Vakwerkhuis



Art. Nr. 130266

D

Vor Beginn des Bastelns sollten Sie sich mit den Spritzlingen und der Anleitung vertraut machen. Sollte es einmal vorkommen, dass ein Teil im Bausatz fehlt, kreuzen Sie bitte das fehlende Teil in der Anleitung an und schicken Sie diese bitte an Fa. Gebr. FALLER GmbH, Abt. Kundendienst, kundendienst@faller.de, Kreuzstraße 9, 78148 Gütenbach. Sie erhalten dann umgehend Ersatz. In diesem Bausatz sind einige Kunststoffteile übrig.

GB

Before beginning with the assembly please familiarize yourself with the parts and read the instructions carefully. In case of missing parts please indicate these on the instructions leaflet with a circle and return the leaflet to Gebr. FALLER GmbH, kundendienst@faller.de, Kreuzstraße 9, D-78148 Gütenbach, Germany. You will receive the replacement by return. Some of the parts in this box are not needed to construct the model.

F

Avant de commencer le montage de votre maquette bien lire la notice et repérer les grappes. Si une pièce manque dans une boîte, cochez la pièce correspondante sur la notice et renvoyez-la-nous à Gebr. FALLER GmbH, kundendienst@faller.de, Kreuzstraße 9, D-78148 Gütenbach (R.F.A.). Nous vous ferons parvenir la pièce par retour. Dans cette boîte se trouvent quelques pièces qui ne seront pas utilisées pour le montage.

NL

Vóór het bouwen zou men de gietstukken en de handleiding moeten bestuderen. Indien onverhoopt een onderdeel aan het bouwpakket ontbreekt, gelieve men het ontbrekende deel in de handleiding aan te kruisen en deze te zenden aan Gebr. FALLER GmbH, kundendienst@faller.de, Kreuzstraße 9, D-78148 Gütenbach. U ontvangt dan omgaand en gratis het ontbrekende onderdeel. Van dit bouwpakket worden enkele kunststof delen niet gebruikt.

Für den Zusammenbau des Modells empfehlen wir folgende FALLER-Artikel (sind nicht im Bausatz enthalten):
For the assembly of the kit we recommend following FALLER products (not included in the kit):
Pour l'assemblage du modèle, nous vous recommandons les articles FALLER suivants (non inclus dans le kit):
Om dit model te bouwen adviseren wij de volgende FALLER producten (maken geen deel uit van deze bouwset):



Art. Nr. 170492
FALLER-EXPERT

Flüssigkleber in Plastikflasche mit Spezialkanüle für feinste Klebstoffdosierung.

Liquid cement in plastic bottle with canule for very fine dosage.

Colle liquide en bouteille plastique avec bec verseur pour un dosage précis.

Vloeibare lijm in plastic-flescon met doseerbuisje om nauwkeurig te lijmen.



Art. Nr. 170688
SPEZIAL-SEITENSCHNEIDER

zum gratfreien Abtrennen von feinsten Spritzteilen.
Nur für Polystyrol geeignet.

Special side cutter for cutting off ultra-fine moulded parts without burrs.
Only suitable for polystyrene.

Pince coupante spéciale pour couper sans bavure les pièces miniatures moulées par injection. Convient uniquement au polystyrène.

Speciale zijkniptang voor het braamloos afknippen van de fijnste gietstukdelen. Alleen geschikt voor polystyrol.

ajckids.com
planetarium automobiles



| | | | | | | | | | |
|-----------------|-------------|-----|-----|----|-----|------|-----|------|-----|
| Inhalt | Spritzlinge | 9 A | 1 x | 11 | 1 x | 14 A | 1 x | 16 A | 1 x |
| Contents | Sprues | 9 B | 1 x | 12 | 1 x | 15 A | 1 x | 16 B | 1 x |
| Contenu | Moulages | 10 | 1 x | 13 | 1 x | 15 B | 1 x | 17 | 1 x |
| Inhoud | Gietstukken | | | | | | | | |

Sa. Nr. 223 810 0

2

Fensterfolie

Die beiliegende Fensterfolie entsprechend der Abbildungen ausschneiden und vorsichtig mit wenig Klebstoff auf die Rückseite der Fensterrahmen aufkleben.

Window foil

Cut the attached window foil according the illustrations and glue it carefully with a little glue to the rear side of the window frames.

Feuillet transparent pour fenêtres

Découper le feuillet transparent pour fenêtres inclus d'après l'illustration. Coller proprement avec un peu de colle sur la face arrière du cadre des fenêtres.

Vensterfolie

De meegeleverde vensterfolie conform de afbeeldingen uitknippen of uitsnijden en voorzichtig met een beetje lijm op de achterzijde van het raam plakken.

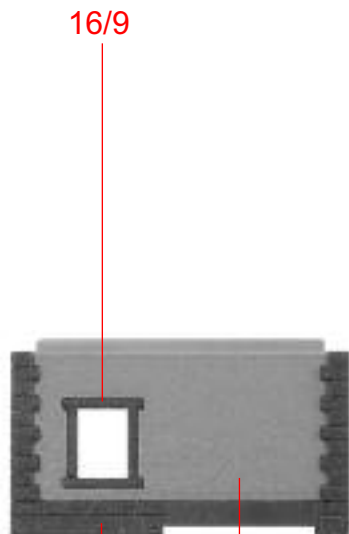

A

16/4

16/15

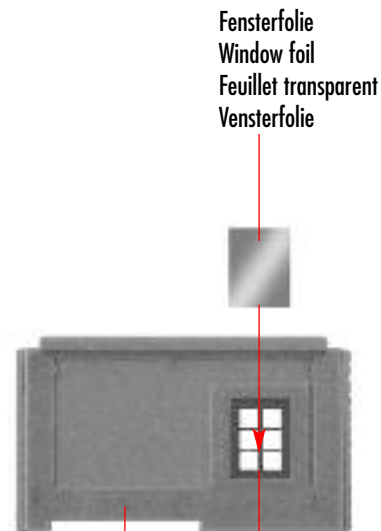

B

A

15/21

Fensterfolie
Window foil
Feuillet transparent
Vensterfolie

C

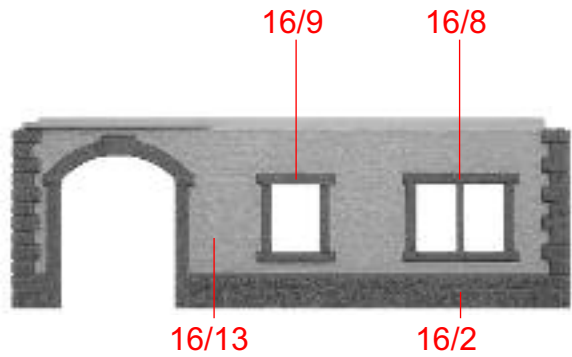

D

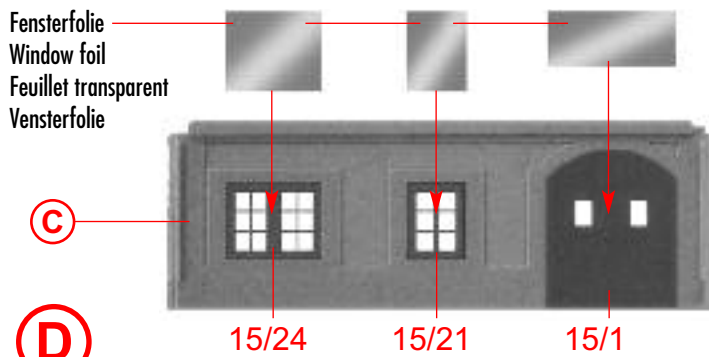

E

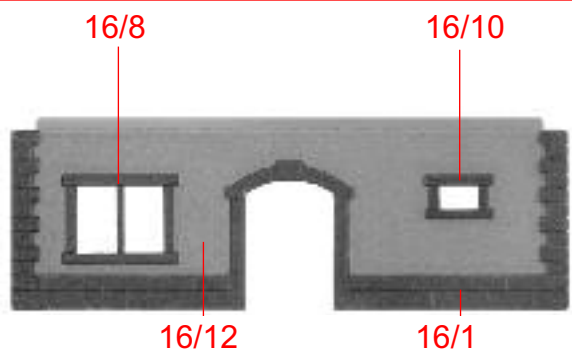

F

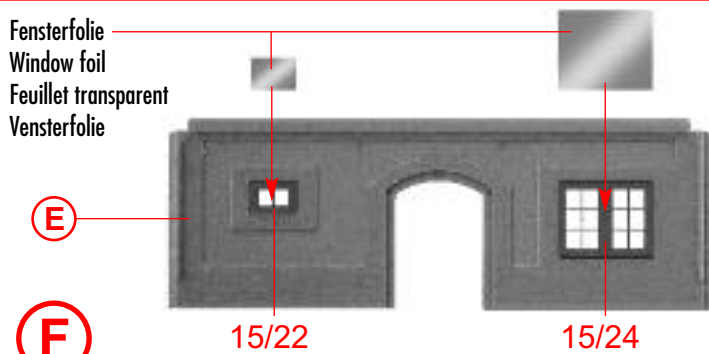

G

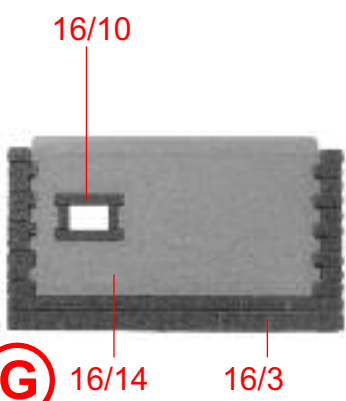

H

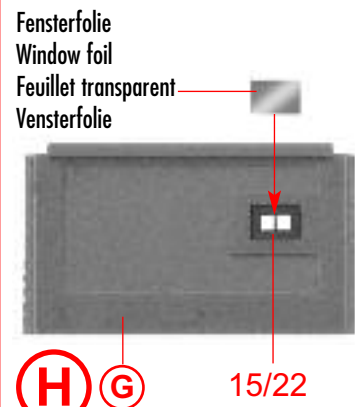

I

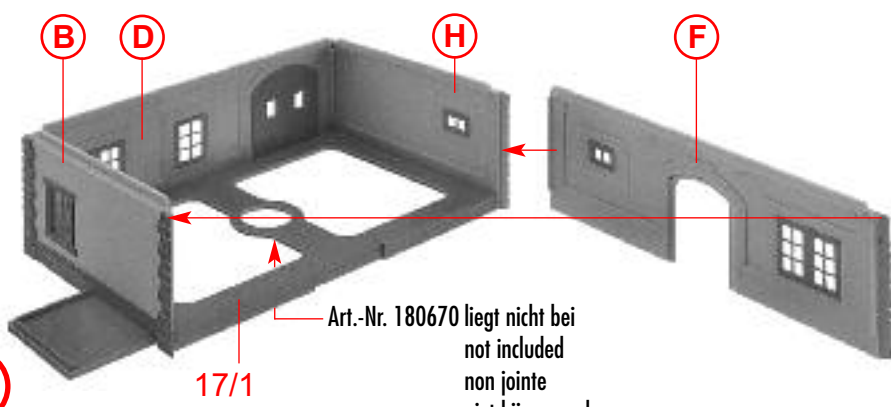

4

10/4

11/11

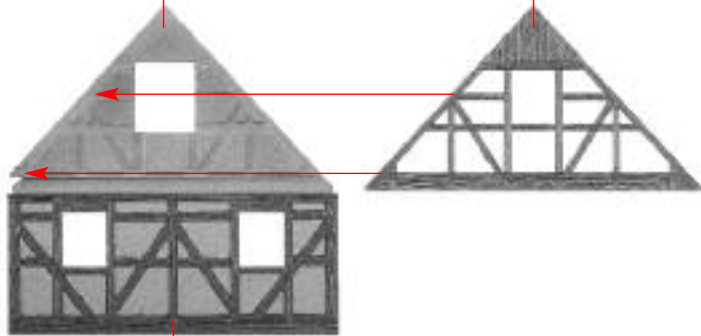

J

11/4

Fensterfolie
Window foil
Feuillet transparent
Vensterfolie

Deco 6

Fensterfolie
Window foil
Feuillet transparent
Vensterfolie

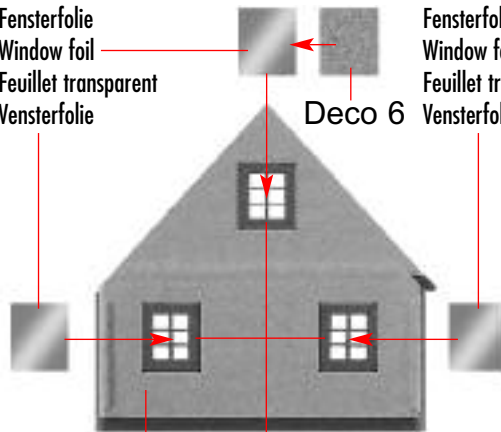

K

J

14/2

9/11

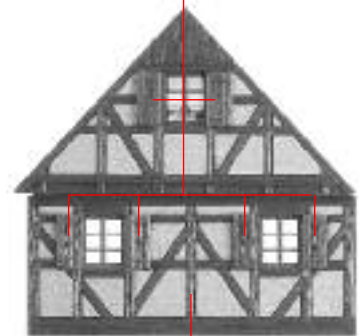

L

K

9/11

11/3

10/3

M

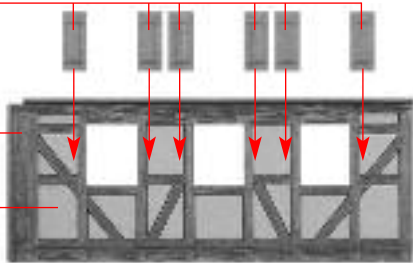

9/11

11/5

10/5

O

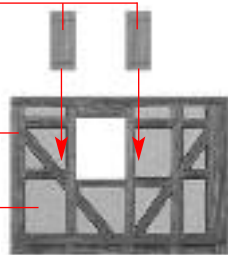

Fensterfolie
Window foil
Feuillet transparent
Vensterfolie

M

14/2

N

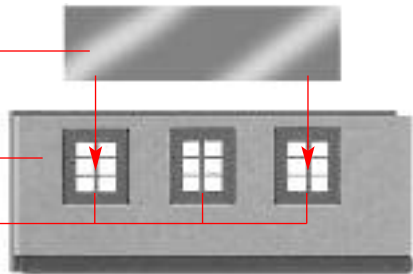

Fensterfolie
Window foil
Feuillet transparent
Vensterfolie

O

14/2

P

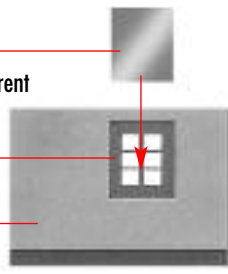

P

L

N

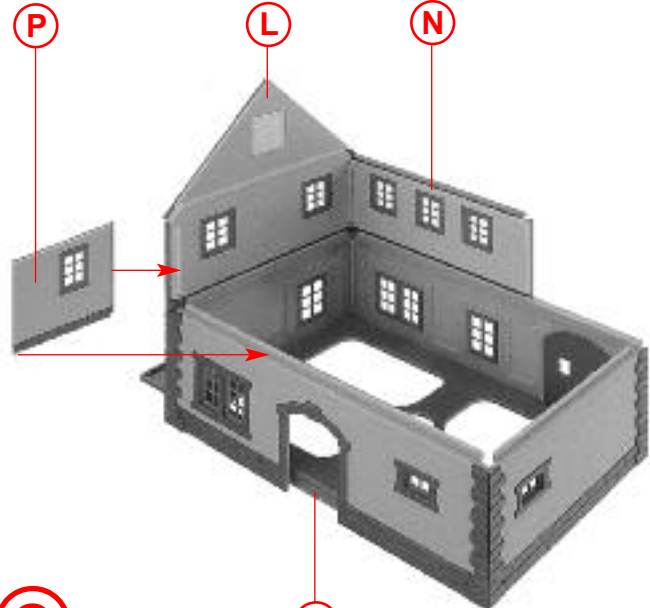

Q

I

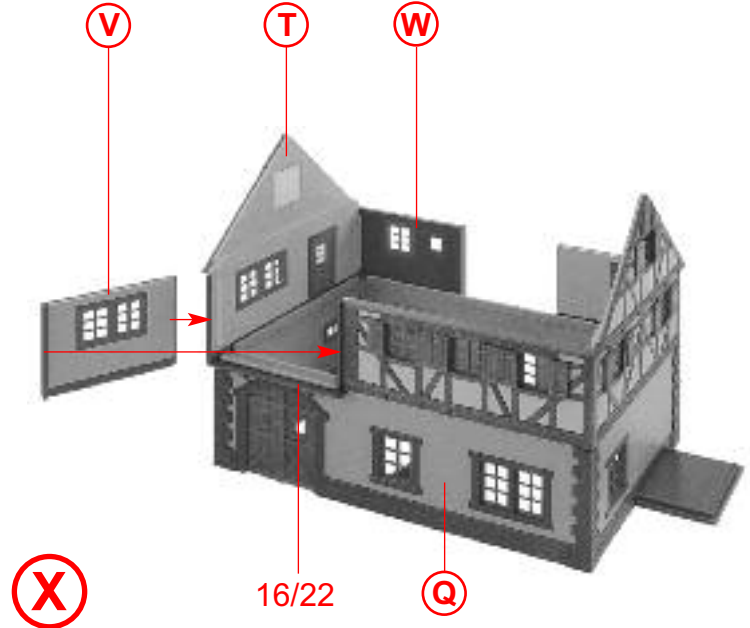
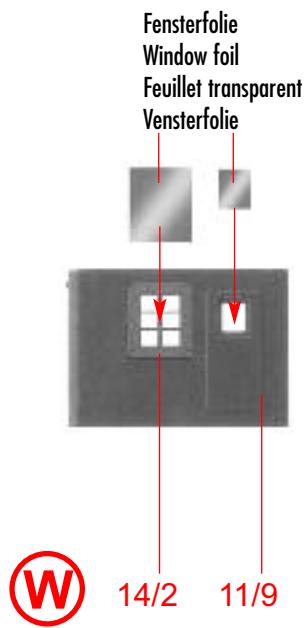
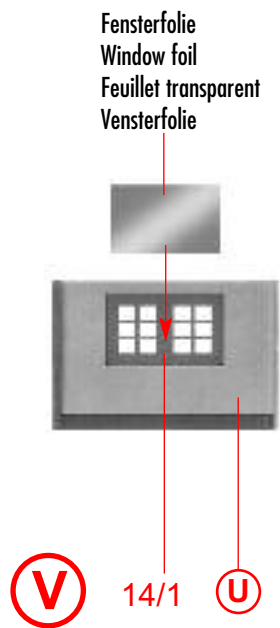
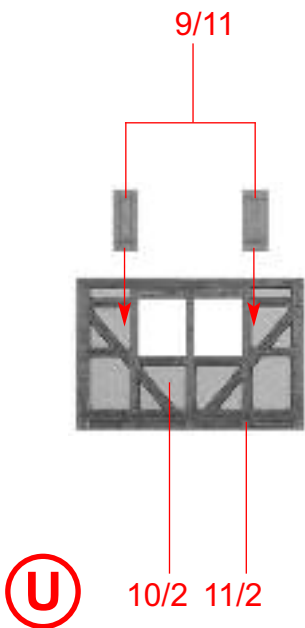
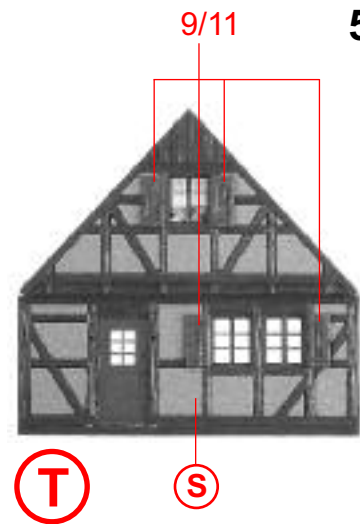
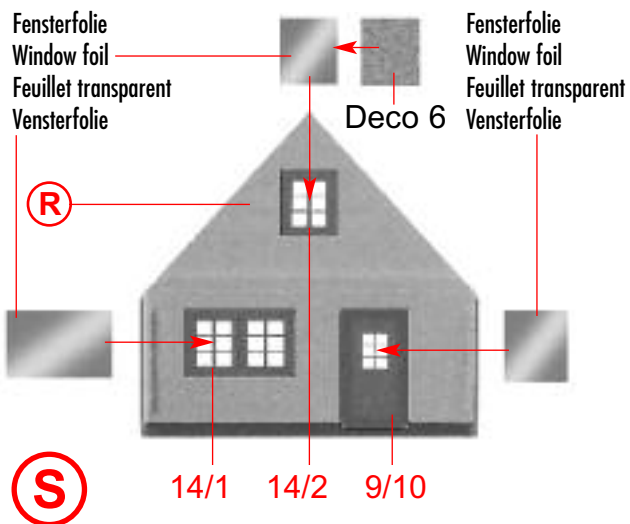
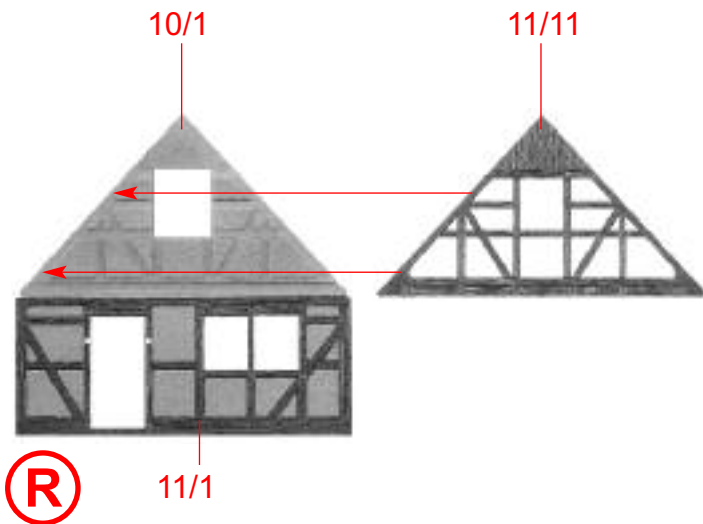

6

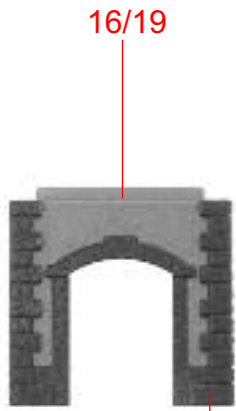

16/19

(a)

16/5

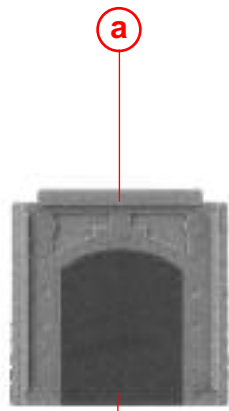

(a)

15/2

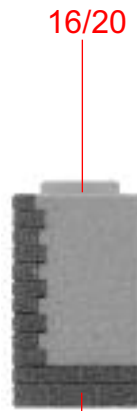

16/20

(c)

16/6



16/21

(d)

16/7

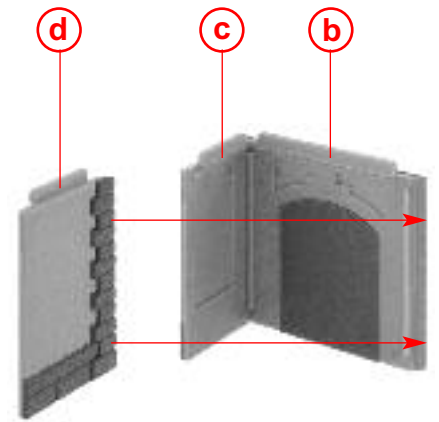

(d)

(c)

(b)

(e)

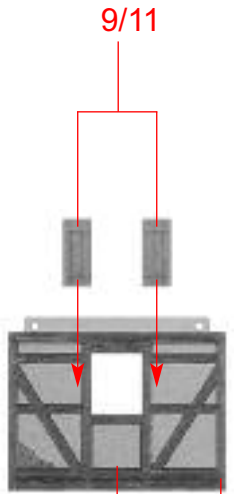

9/11

(f)

10/8

11/8

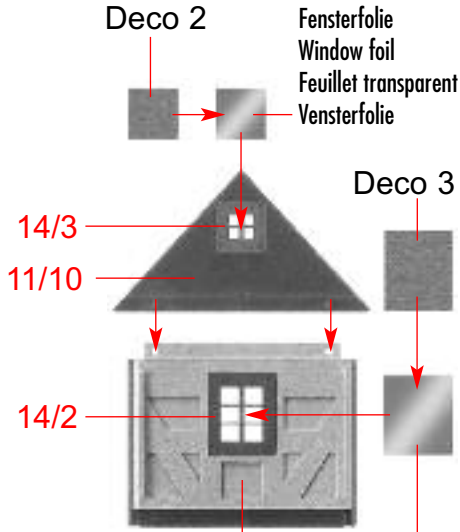

Deco 2

Fensterfolie
Window foil
Feuillet transparent
Vensterfolie

14/3

11/10

Deco 3

14/2

(f)

Fensterfolie
Window foil
Feuillet transparent
Vensterfolie

(g)

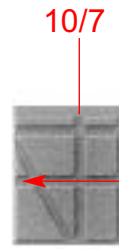

10/7

(h)

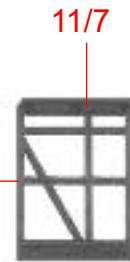

11/7



10/6

(i)



11/6

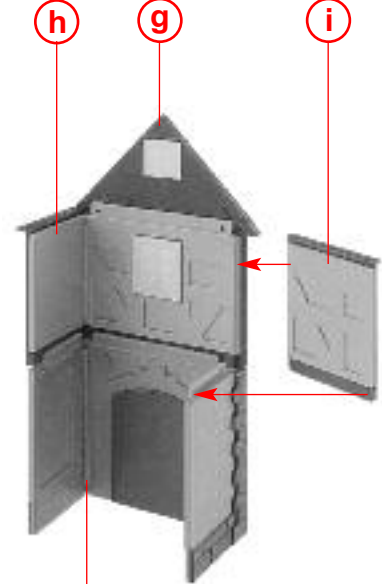

(h)

(g)

(i)

(j)

(e)

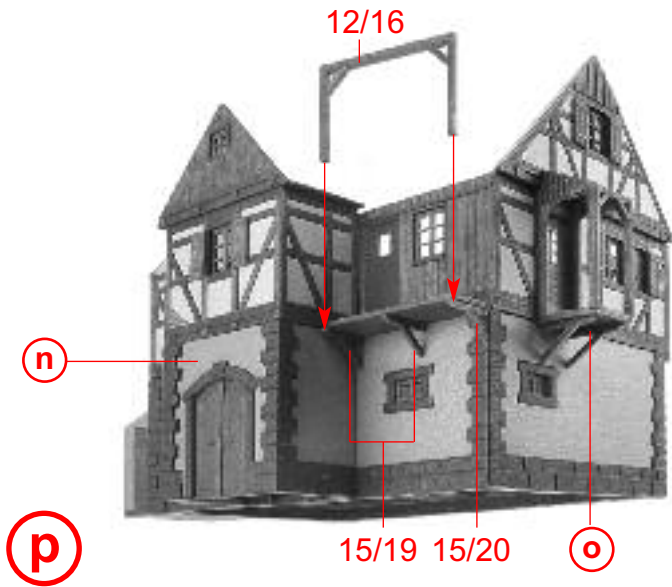
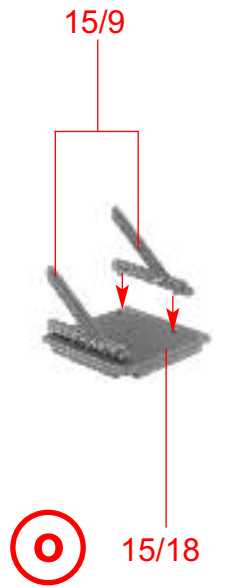
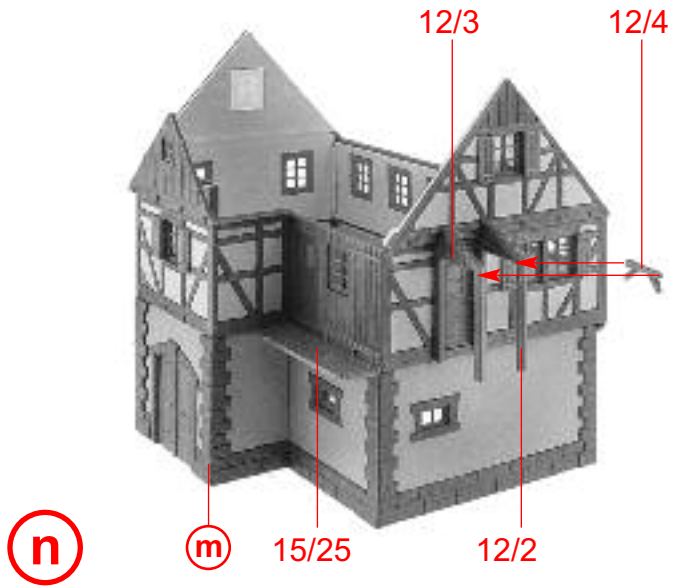
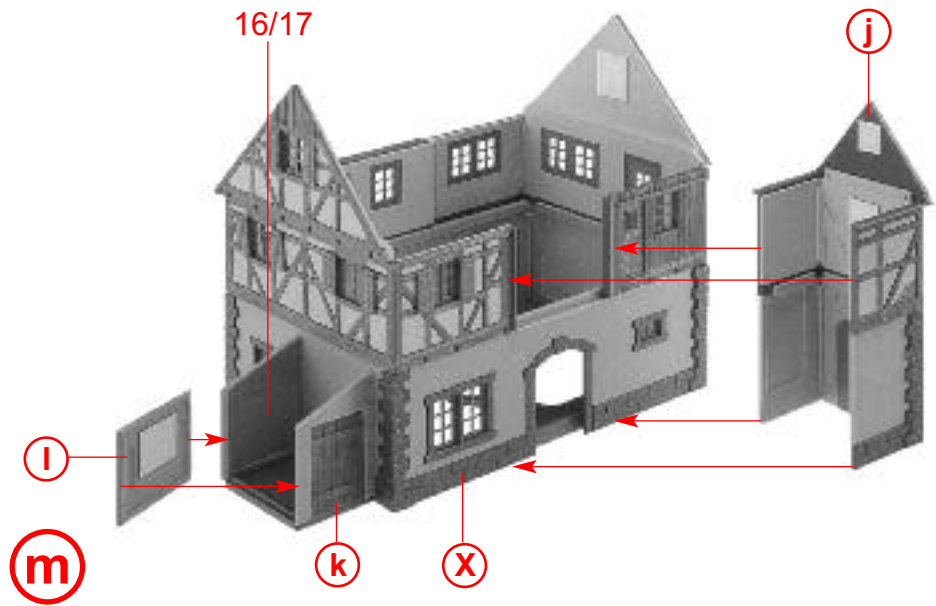
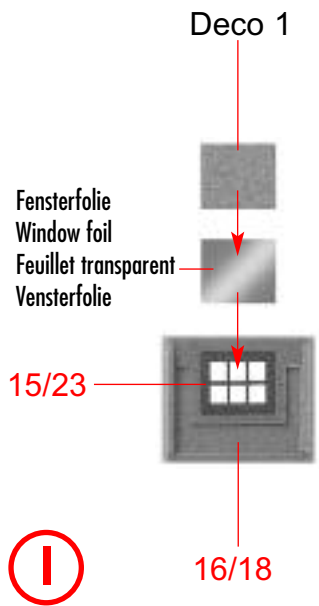
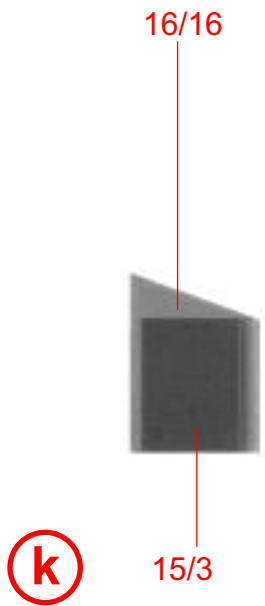

8

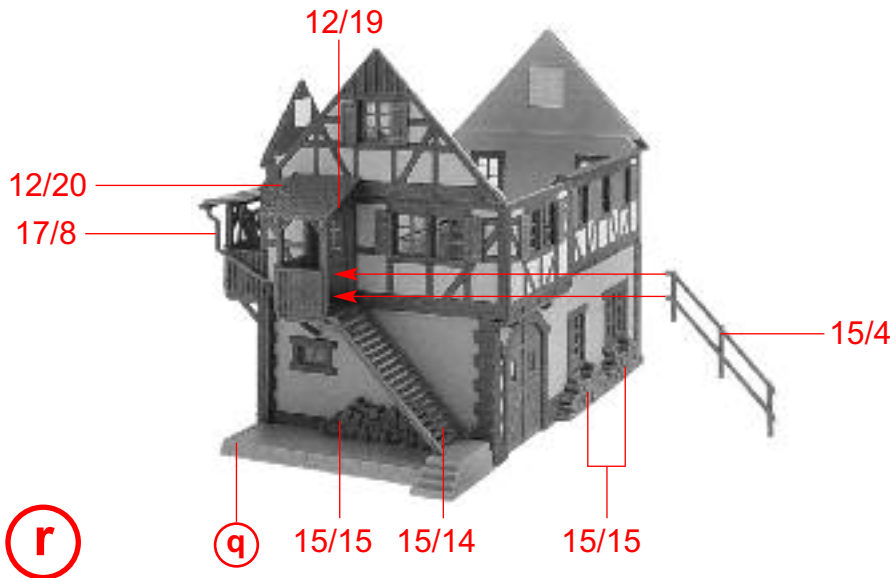
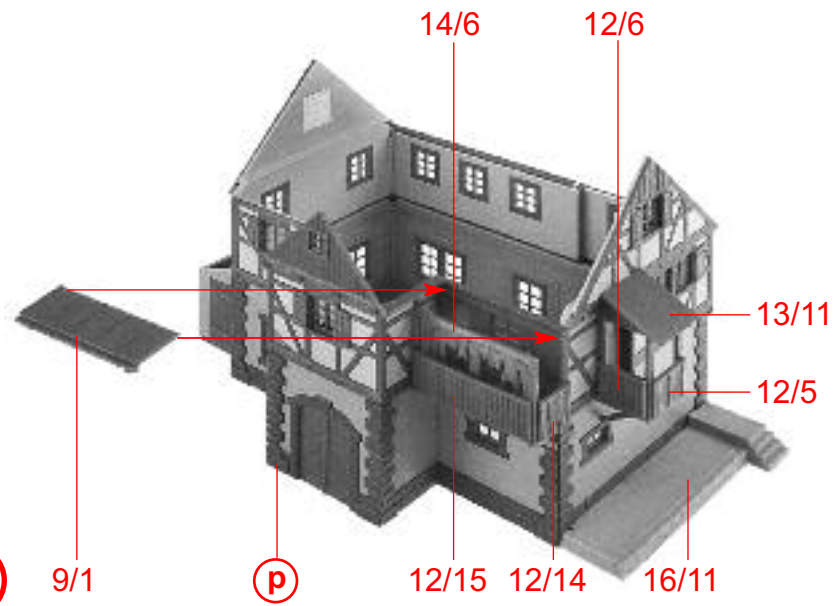

Papiermaske
 Papermask
 Masque
 Masker **M2**



M1

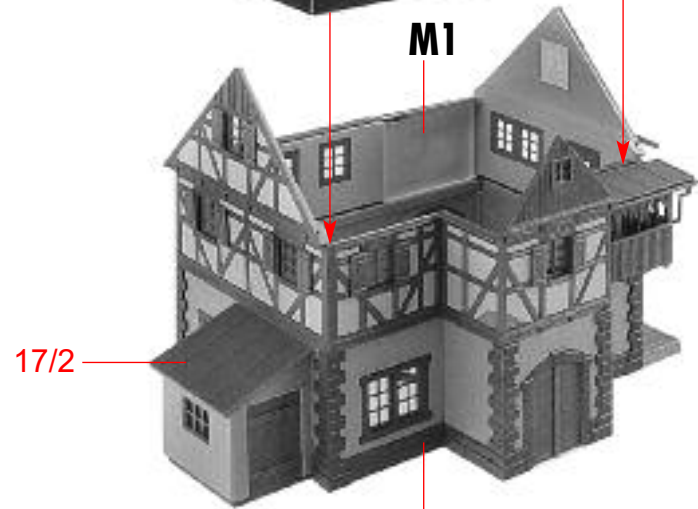

13/1 13/8 13/2

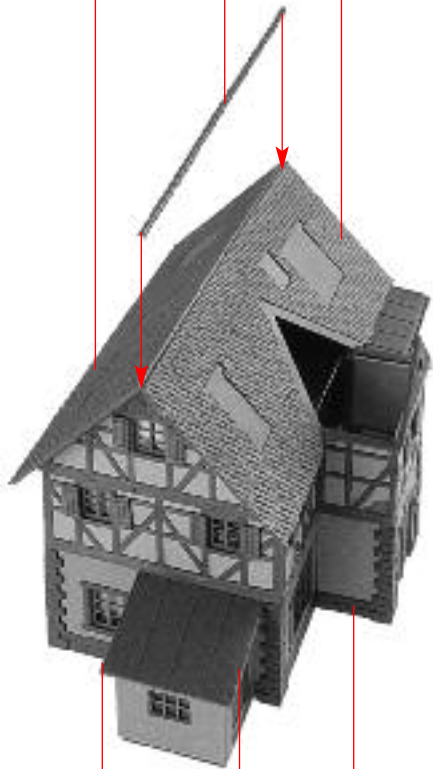

t

15/17

15/16

s

12/21 12/22 13/4 13/3

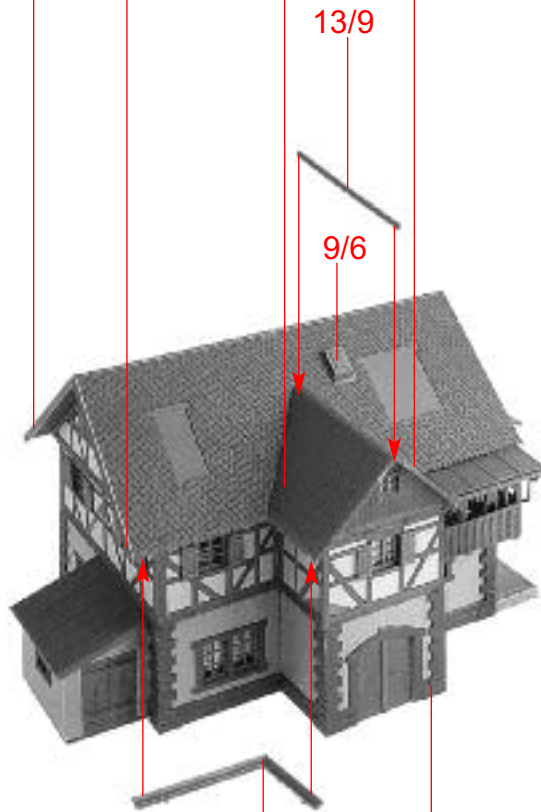

u

9/3

t

12/24 12/23 9/2 12/21

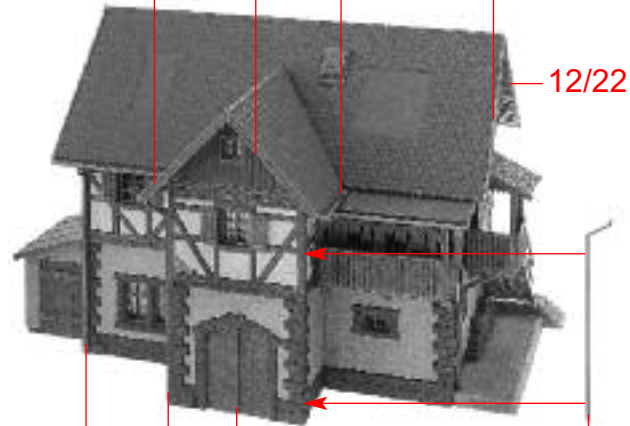

v

17/7

17/4

u

17/4

10

Deco 4

Deco 5

Fensterfolie
Window foil
Feuillet transparent
Vensterfolie

Fensterfolie
Window foil
Feuillet transparent
Vensterfolie

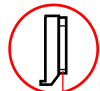
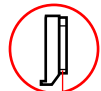

14/5

14/4

(A) 4 x 12/11

(C) 2 x 12/10

10/9

10/10

(E) 10/12 10/11

(D)

9/4

17/5

17/4

(G)

(V)

12/12

12/13

12/12

12/13

(A)

(B) 4 x

(C)

(D) 2 x

13/10

13/7

13/7

(F) **(E)**

13/6

(B) 9/5

13/6

13/5

(F)

(H) 13/5

(G)

(D)

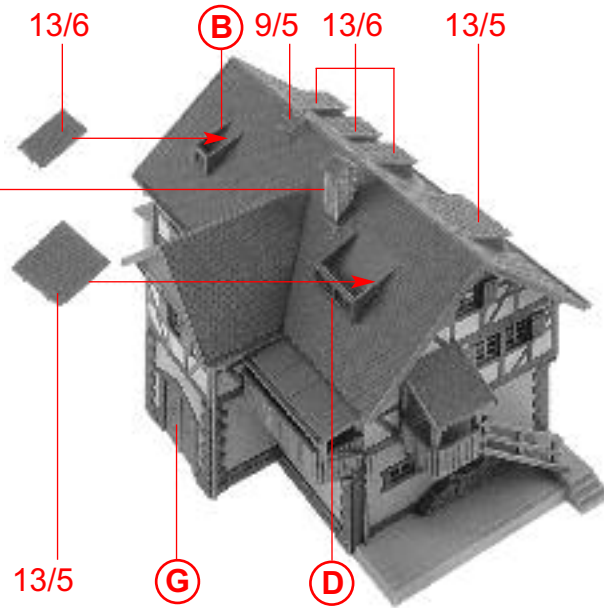
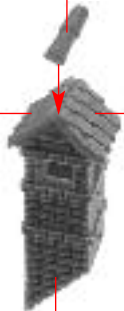
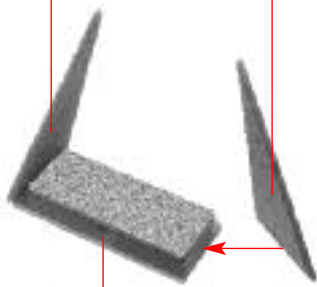
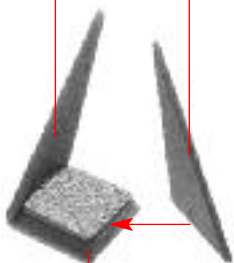
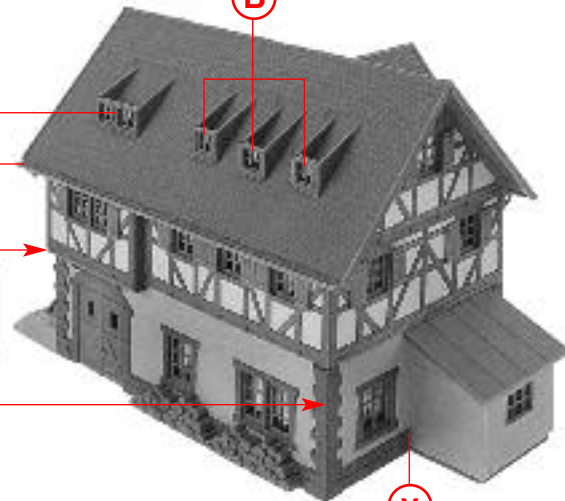
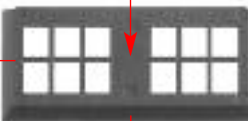
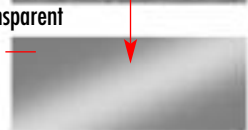
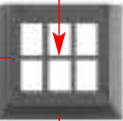
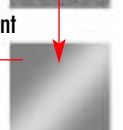
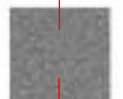

| | | | |
|---------|--------|----------|-------|
| Inhalt | Tüte | Contents | bag |
| Contenu | sachet | Inhoud | zakje |

12/17

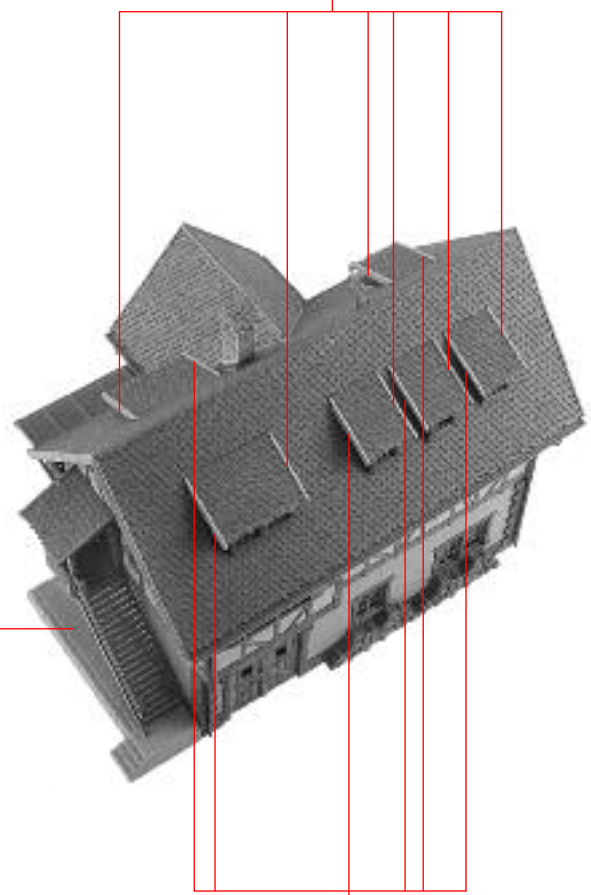

H

I

12/18

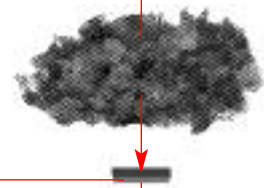

12/26

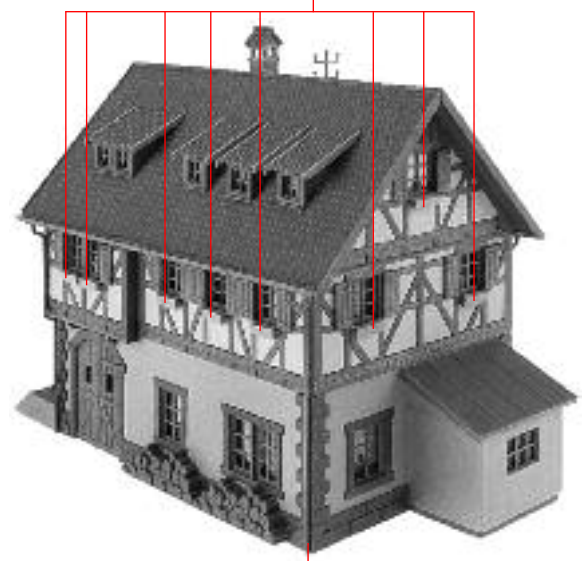

J

I

12

| | | | |
|---------|--------|----------|-------|
| Inhalt | Tüte | Contents | bag |
| Contenu | sachet | Inhoud | zakje |

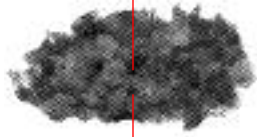

12/26

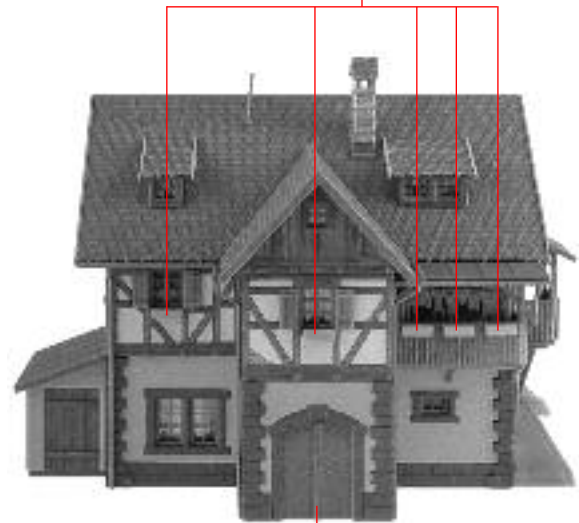

K

J

| | | | |
|---------|--------|----------|-------|
| Inhalt | Tüte | Contents | bag |
| Contenu | sachet | Inhoud | zakje |

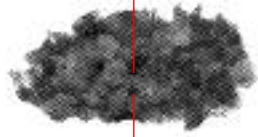

12/26



L

K

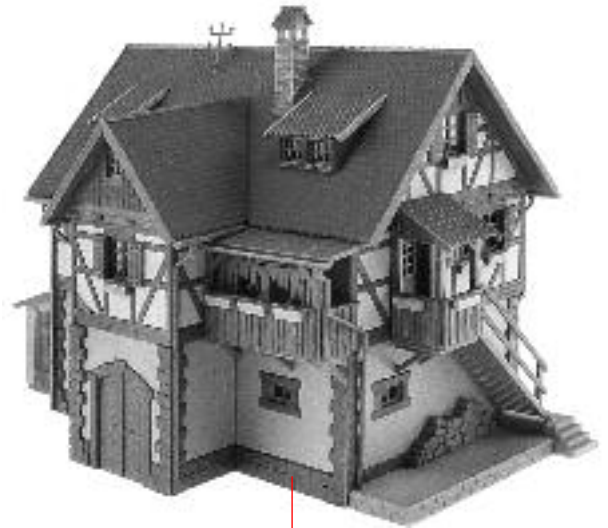

M

L