

HAUPTFEUERWACHE

CENTRAL FIRE STATION

POSTE DE POMPIERS CENTRAL

HOOFDGEBOUW VAN DE BRANDWEER



Art. Nr. 130163

D

Vor Beginn des Bastelns sollten Sie sich mit den Spritzlingen und der Anleitung vertraut machen. Sollte es einmal vorkommen, dass ein Teil im Bausatz fehlt, kreuzen Sie bitte das fehlende Teil in der Anleitung an und schicken Sie diese bitte an Fa. Gebr. FALLER GmbH, Abt. Kundendienst, kundendienst@faller.de, Kreuzstraße 9, 78148 Güttenbach. Sie erhalten dann umgehend Ersatz. Es kann vorkommen, dass bei einem Bausatz Einzelteile übrig sind.

GB

Before beginning with the assembly please familiarize yourself with the parts and read the instructions carefully. In case of missing parts please indicate these on the instructions leaflet with a circle and return the leaflet to Gebr. FALLER GmbH, kundendienst@faller.de, Kreuzstraße 9, D-78148 Güttenbach, Germany. You will receive the replacement by return. It may happen in a kit that some parts are not required.

F

Avant de commencer le montage de votre maquette bien lire la notice et repérer les grappes. Si une pièce manque dans une boîte, cochez la pièce correspondante sur la notice et renvoyez-la-nous à Gebr. FALLER GmbH, kundendienst@faller.de, Kreuzstraße 9, D-78148 Güttenbach (R.F.A.). Nous vous ferons parvenir la pièce par retour. Dans certains kits, il est possible que certaines pièces ne soient pas utilisées.

NL

Vóór het bouwen zou men de gietstukken en de handleiding moeten bestuderen. Indien onverhoopt een onderdeel aan het bouwpakket ontbreekt, gelieve men het ontbrekende deel in de handleiding aan te kruisen en deze te zenden aan Gebr. FALLER GmbH, kundendienst@faller.de, Kreuzstraße 9, D-78148 Güttenbach. U ontvangt dan omgaand en gratis het ontbrekende onderdeel. Het kan voorkomen dat u bij bepaalde bouwdozen onderdelen overhoudt.

Für den Zusammenbau des Modells empfehlen wir folgende FALLER-Artikel (sind nicht im Bausatz enthalten):
For the assembly of the kit we recommend following FALLER products (not included in the kit):
Pour l'assemblage du modèle, nous vous recommandons les articles FALLER suivants (non inclus dans le kit):
Om dit model te bouwen adviseren wij de volgende FALLER producten (maken geen deel uit van deze bouwset):



Art. Nr. 170492
FALLER-EXPERT
Flüssigkleber in Plastikflasche mit Spezialkanüle für feinste Klebstoffdosierung.

Liquid cement in plastic bottle with canule for very fine dosage.

Cette liquide en bouteille plastique avec bec verseur pour un dosage précis.

Vloeibare lijm in plastic-flescom met doseerbuisje om nauwkeurig te lijmen.



Art. Nr. 170698
SPEZIAL-SETZENSCHNEIDER
zum geräusefreien Abtrennen von feinsten Spritzteilen.
Nur für Polystyrol geeignet.

Special side cutter for cutting off ultra-fine moulded parts without burrs. Only suitable for polystyrene.

Pince coupante spéciale pour couper sans bavure les pièces miniatures moulées par injection. Convient uniquement au polystyrène.

Speciale zijknipslang voor het braamloos afknippen van de fijnste gietstukdelen. Alleen geschikt voor polystyrol.



ajckids.com
planes, trains automobiles

Inhalt	Spritzlinge	13	1 x	15	1 x	18	1 x	21	1 x
Contents	Sprues	14 A	1 x	16	1 x	19	2 x	22	1 x
Contenu	Moulages	14 B	1 x	17	2 x	20	1 x	23	1 x
Inhoud	Gietstukken								

Inhalt	Spritzlinge	24	1 x	27	2 x	30	2 x	33	2 x
Contents	Sprues	25	1 x	28	2 x	31	1 x	37	1 x
Contenu	Moulages	26	1 x	29	3 x	32	1 x		
Inhoud	Gietstukken								

Sa. Nr. 130 163 1

Fensterfolie

Die beiliegende Fensterfolie entsprechend der benötigten Größe ausschneiden und vorsichtig mit wenig Klebstoff auf die Rückseite der Fensterrahmen aufkleben.

Window foil

Cut the attached window foil according the illustrations and glue it carefully with a little glue to the rear side of the window frames.

Feuille transparent pour fenêtres

Découper le feuille transparent pour fenêtres inclus d'après l'illustration. Coller proprement avec un peu de colle sur la face arrière du cadre des fenêtres.

Vensterfolie

De meegeleverde vensterfolie conform de afbeeldingen uitknippen of uitsnijden en voorzichtig met een beetje lijm op de achterzijde van het raam plakken.

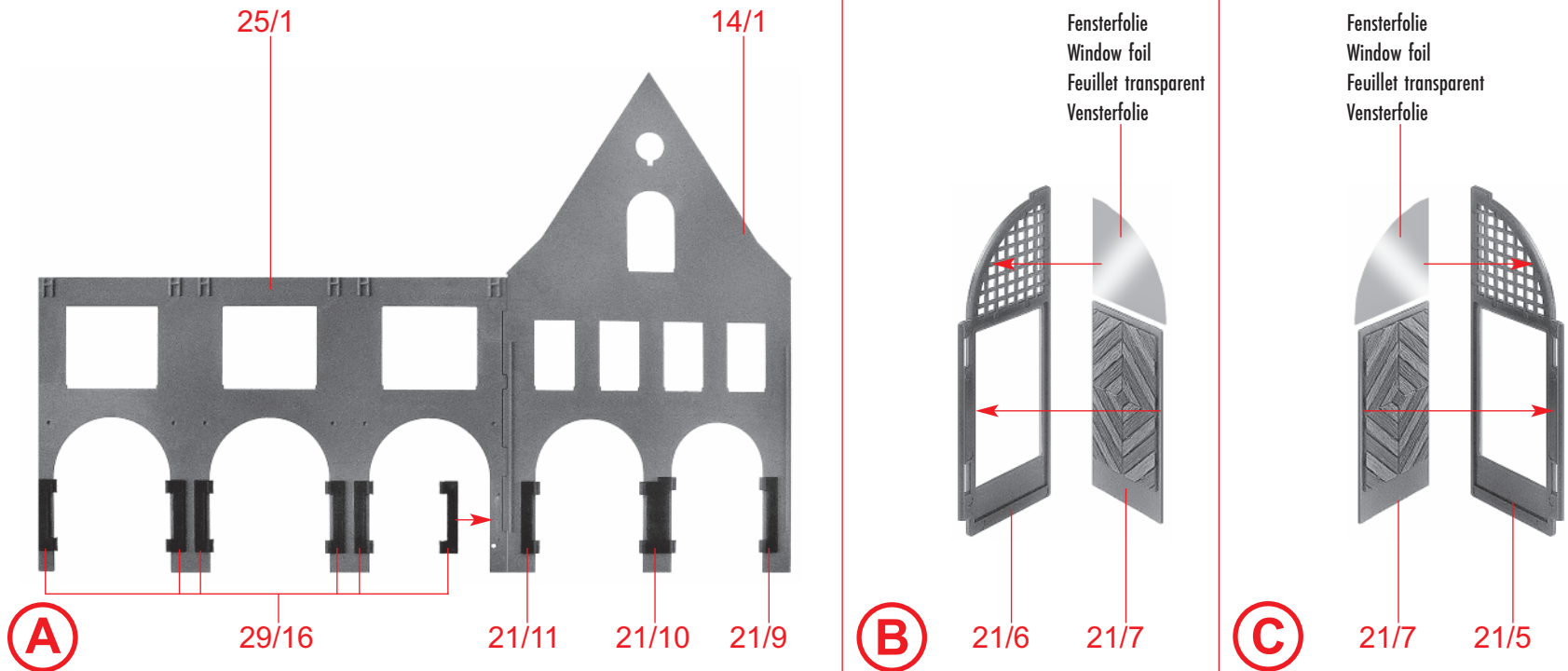

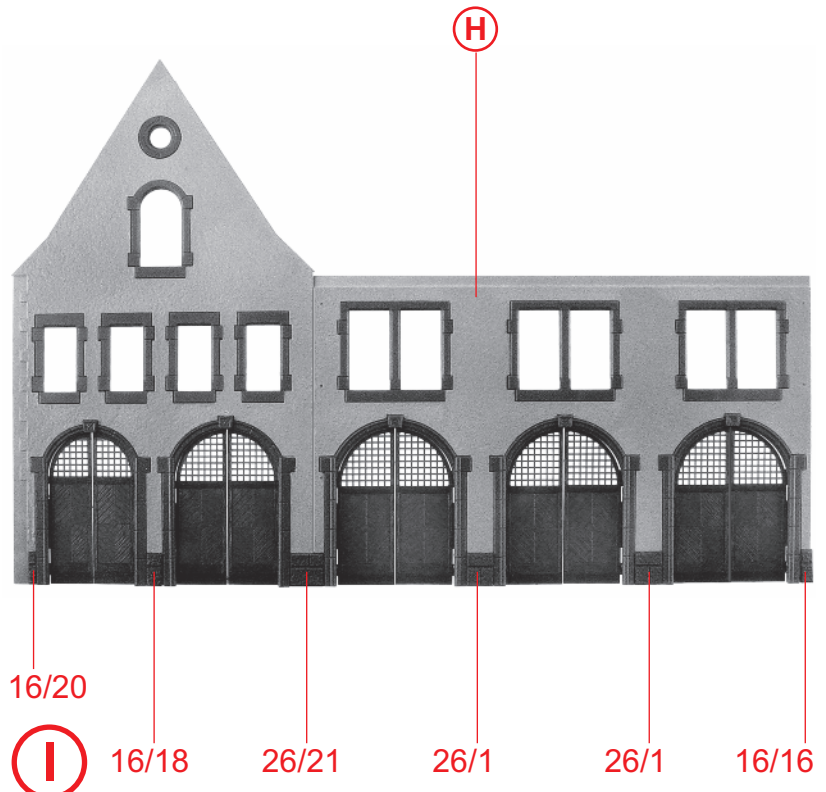
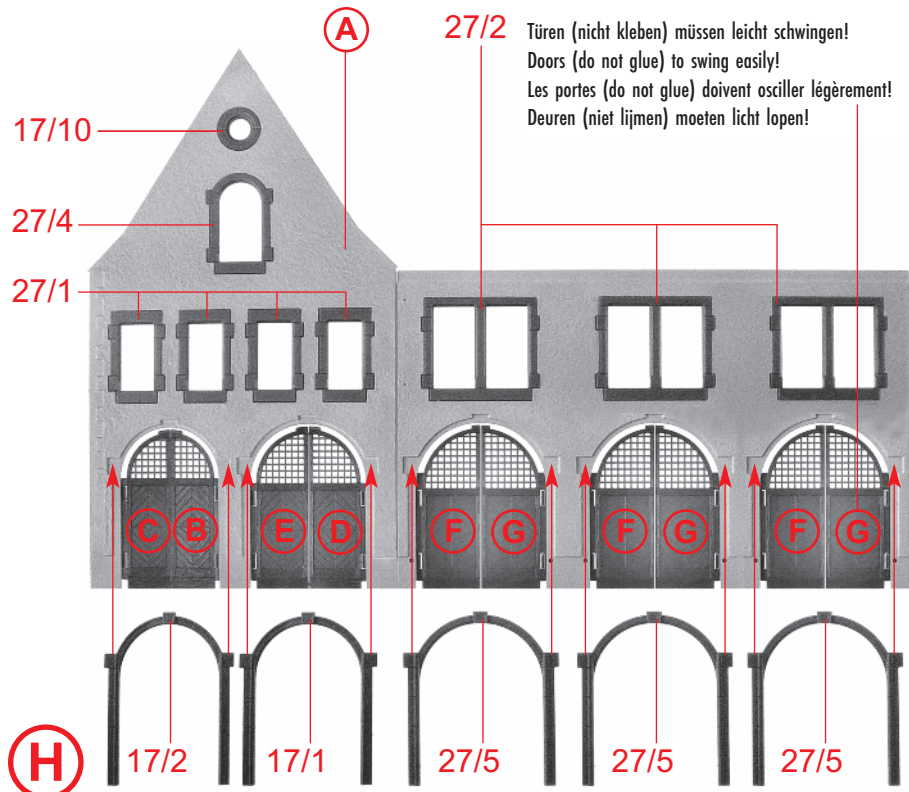
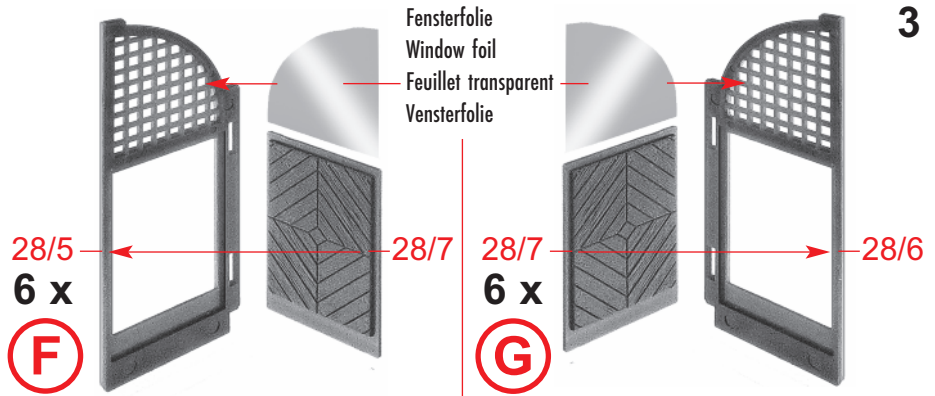
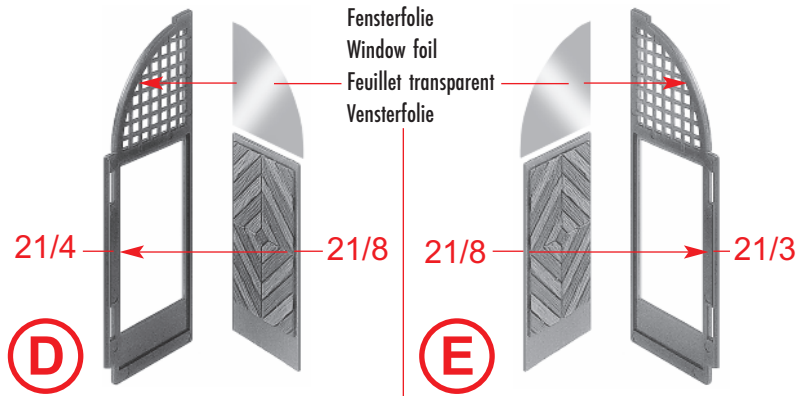

4

I

Fensterfolie
Window foil
Feuillet transparent
Vensterfolie

Deco 19

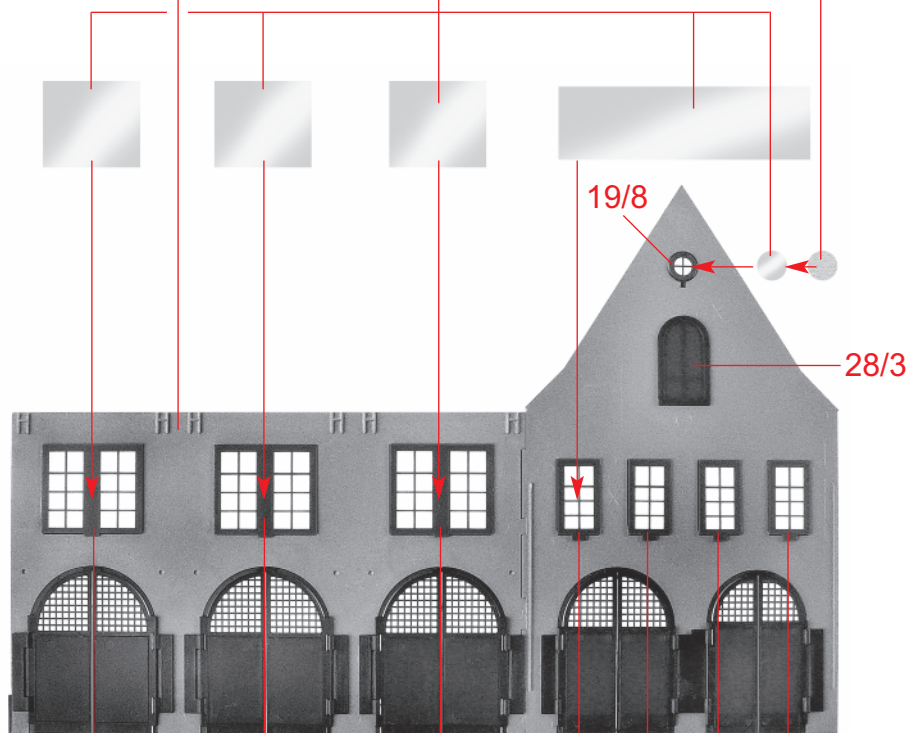

J

30/1

30/2

25/2

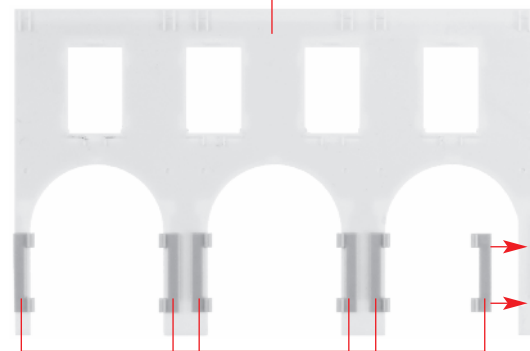

K

37/2

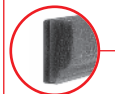

L

26/10

27/8

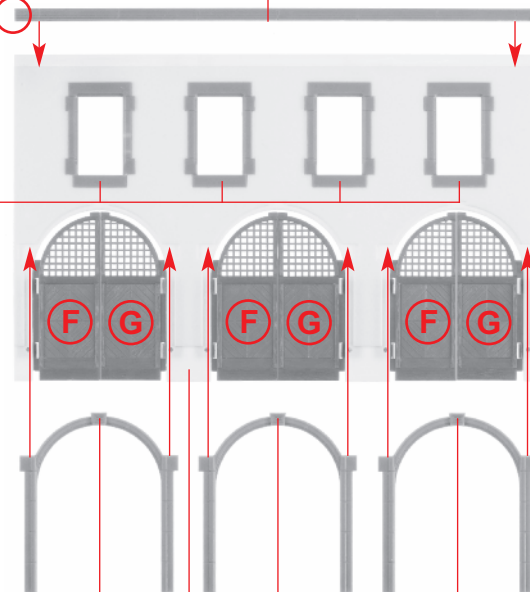

27/5

K

27/5

27/5

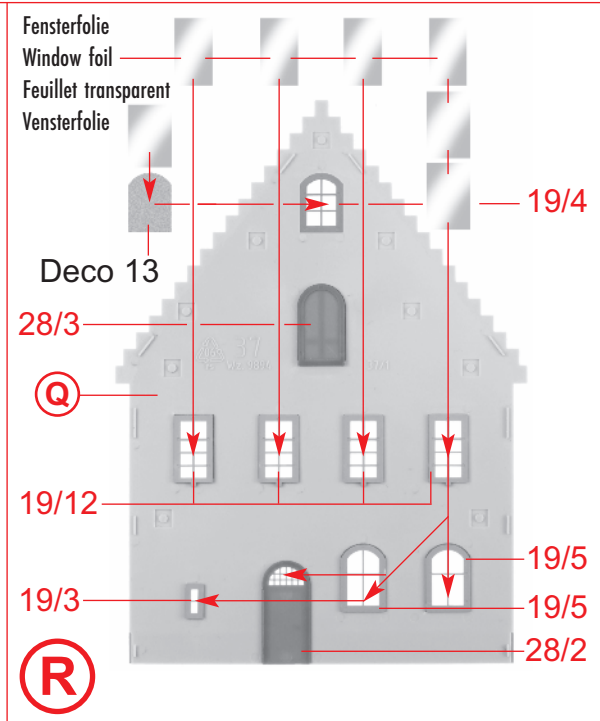
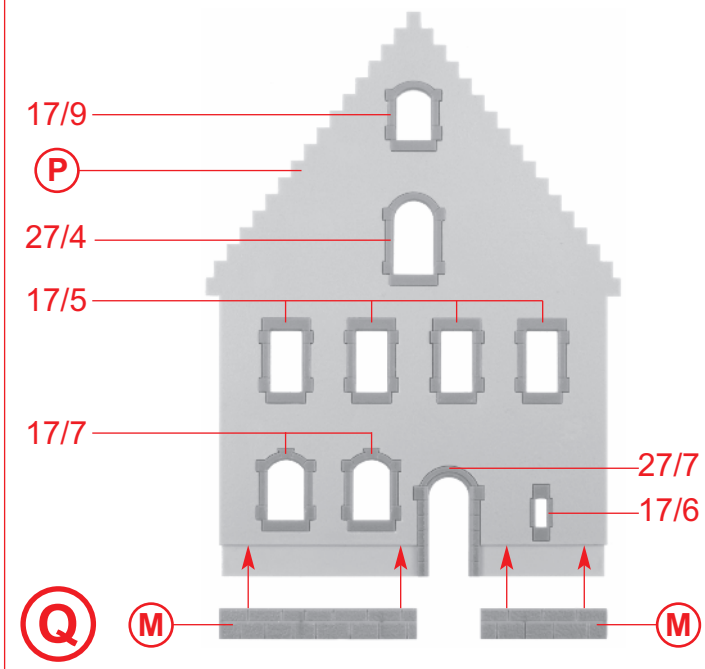
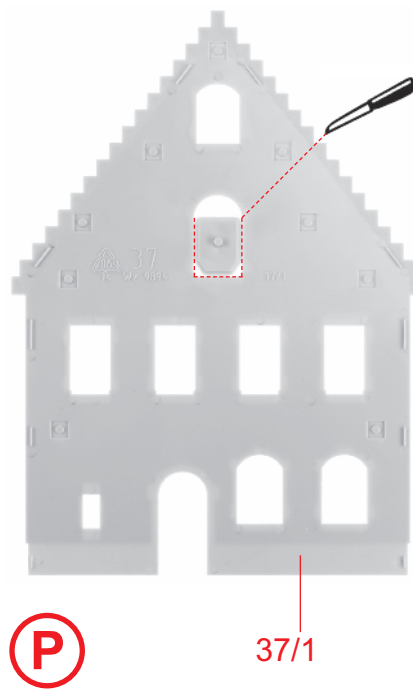
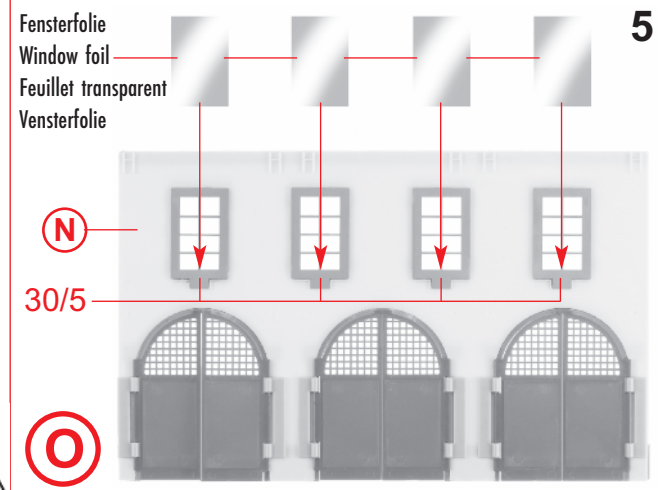
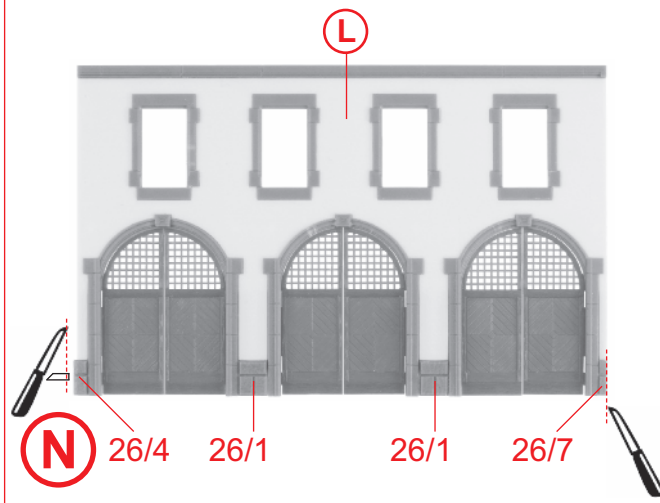
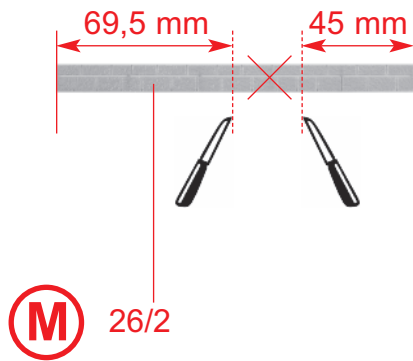

6

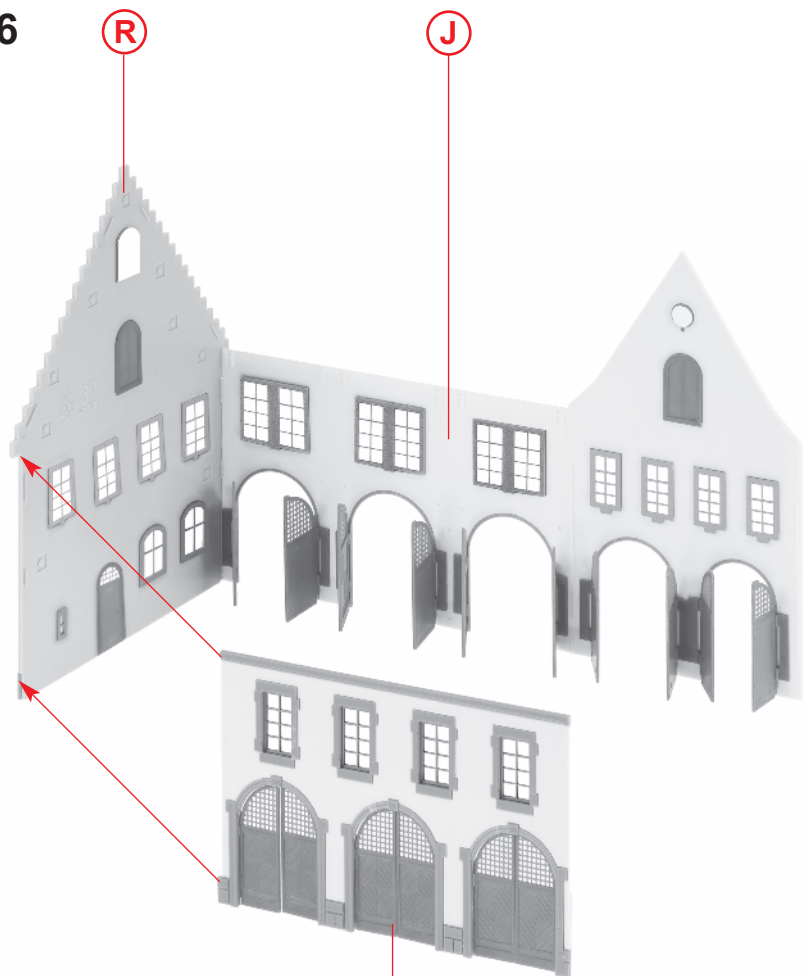

S

O

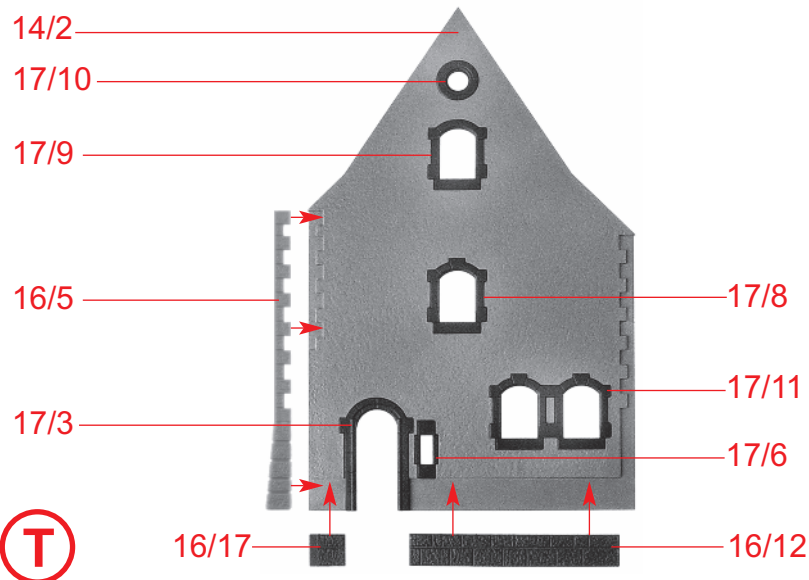

T

T

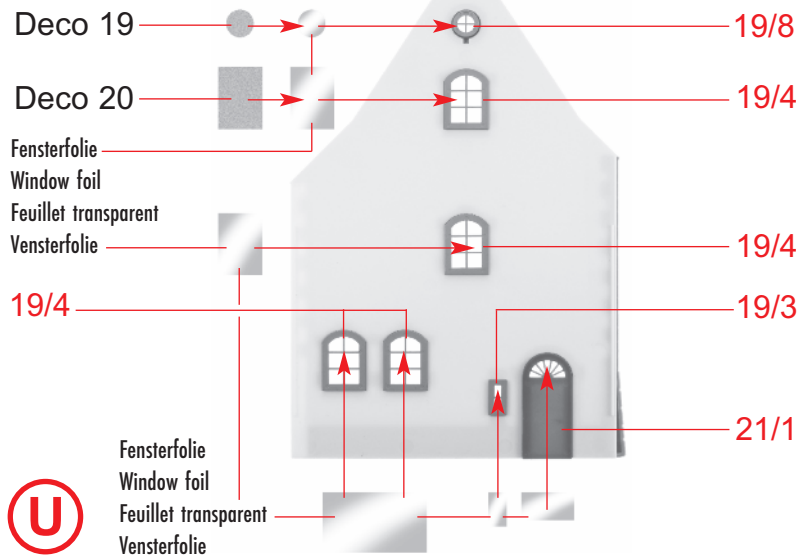

U

8

20/4

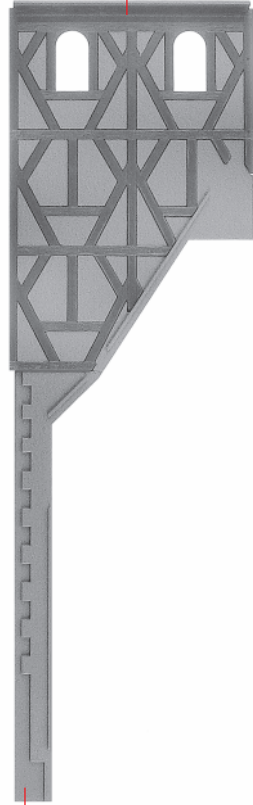

Fensterfolie
Window foil
Feuillet transparent
Vensterfolie

Deco 17

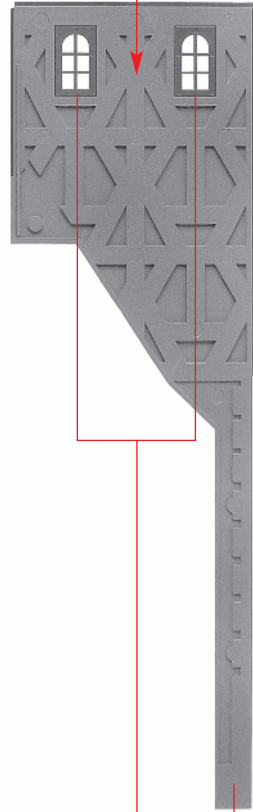
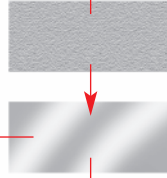

19/1

a

20/3

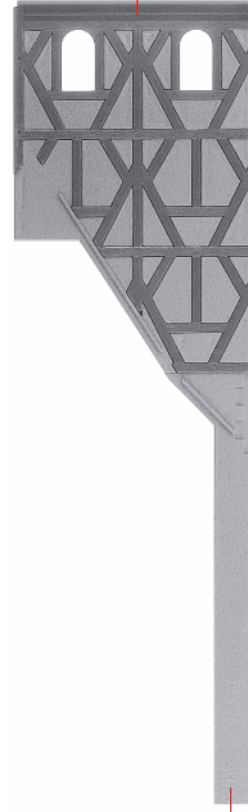

15/3

Deco 17

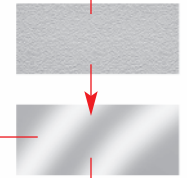

Fensterfolie
Window foil
Feuillet transparent
Vensterfolie

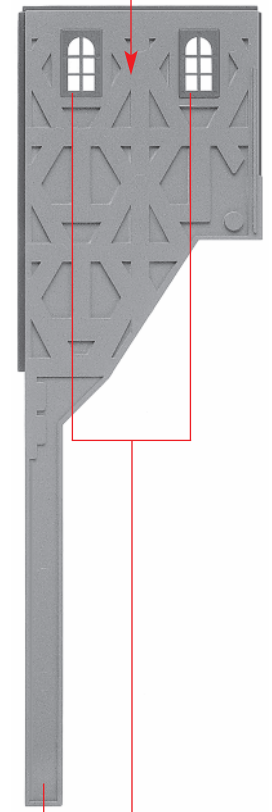

19/1

c

a

13/2

b

c

d

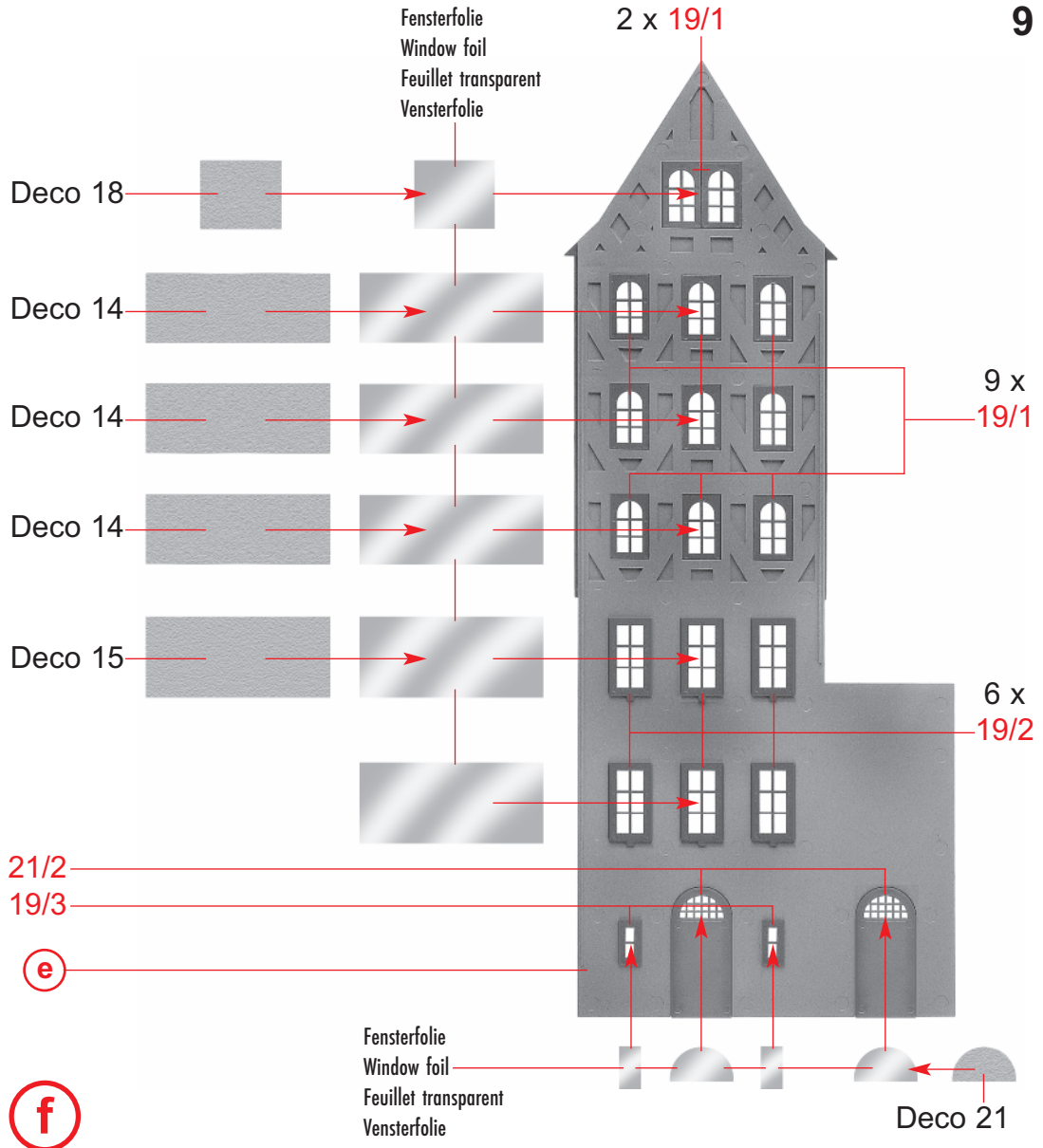
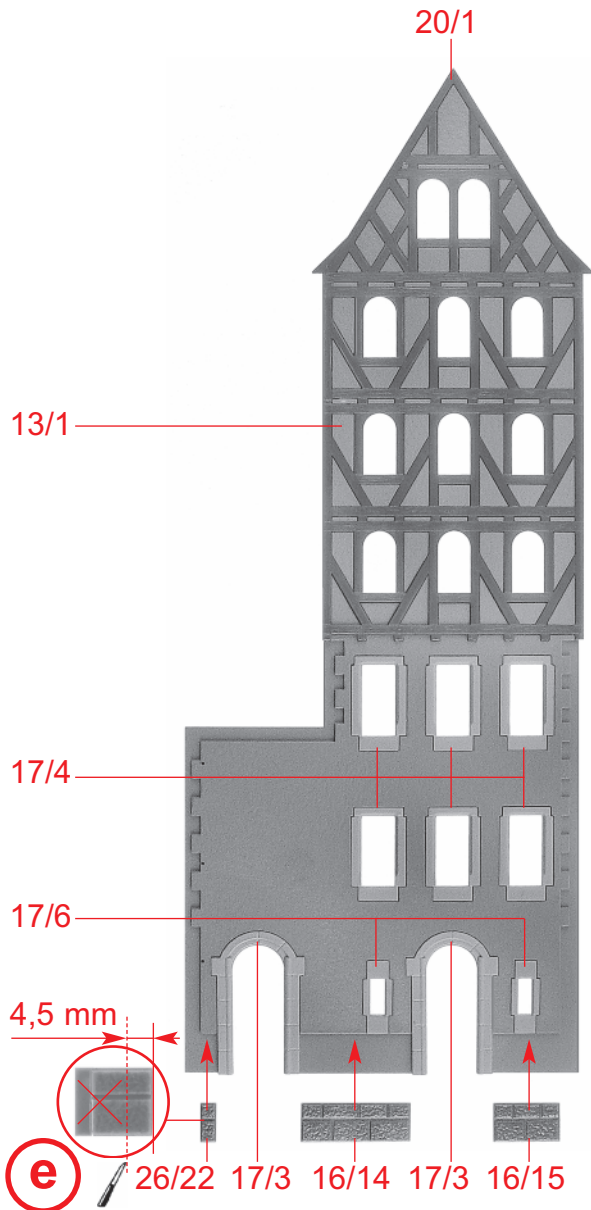

10

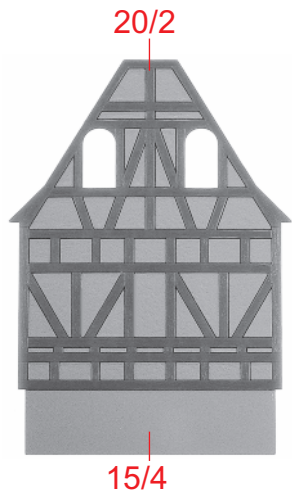

g

Deco 16



Fensterfolie
Window foil
Feuillet transparent
Vensterfolie

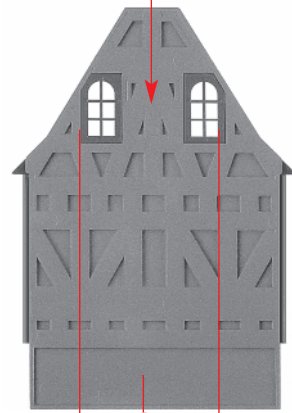

19/6 g 19/7

h

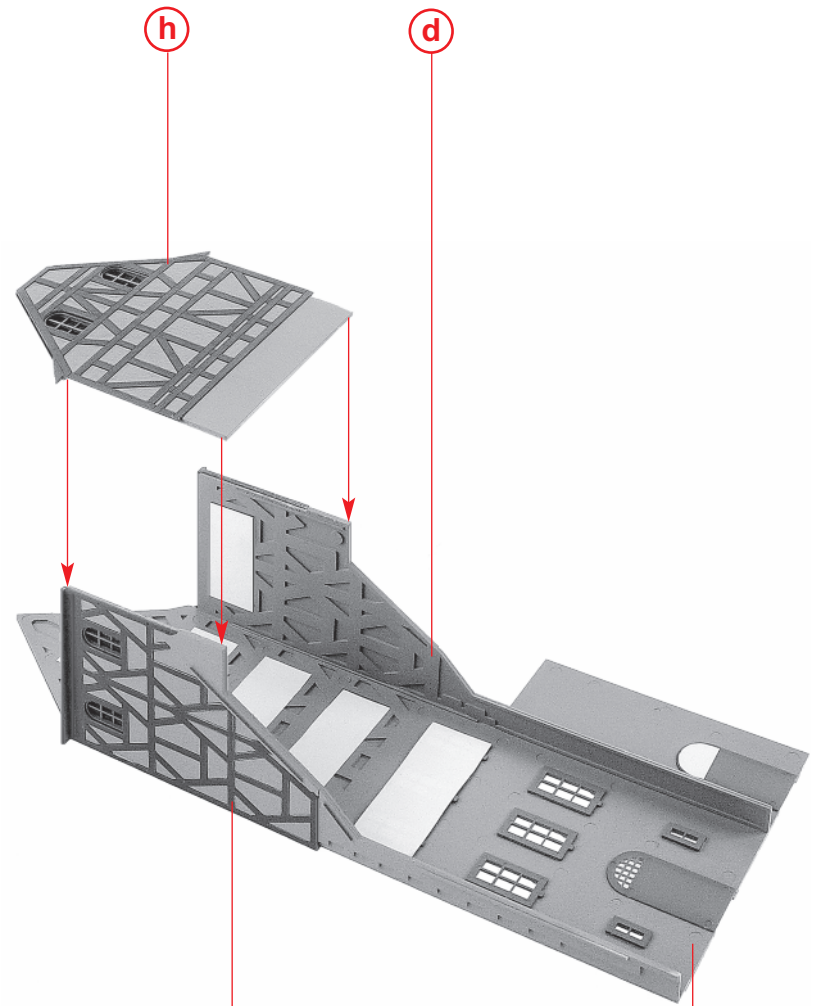

i

b

f

31/2

31/1

Papiermaske
Papermask
Masque
Masker **M5**

i

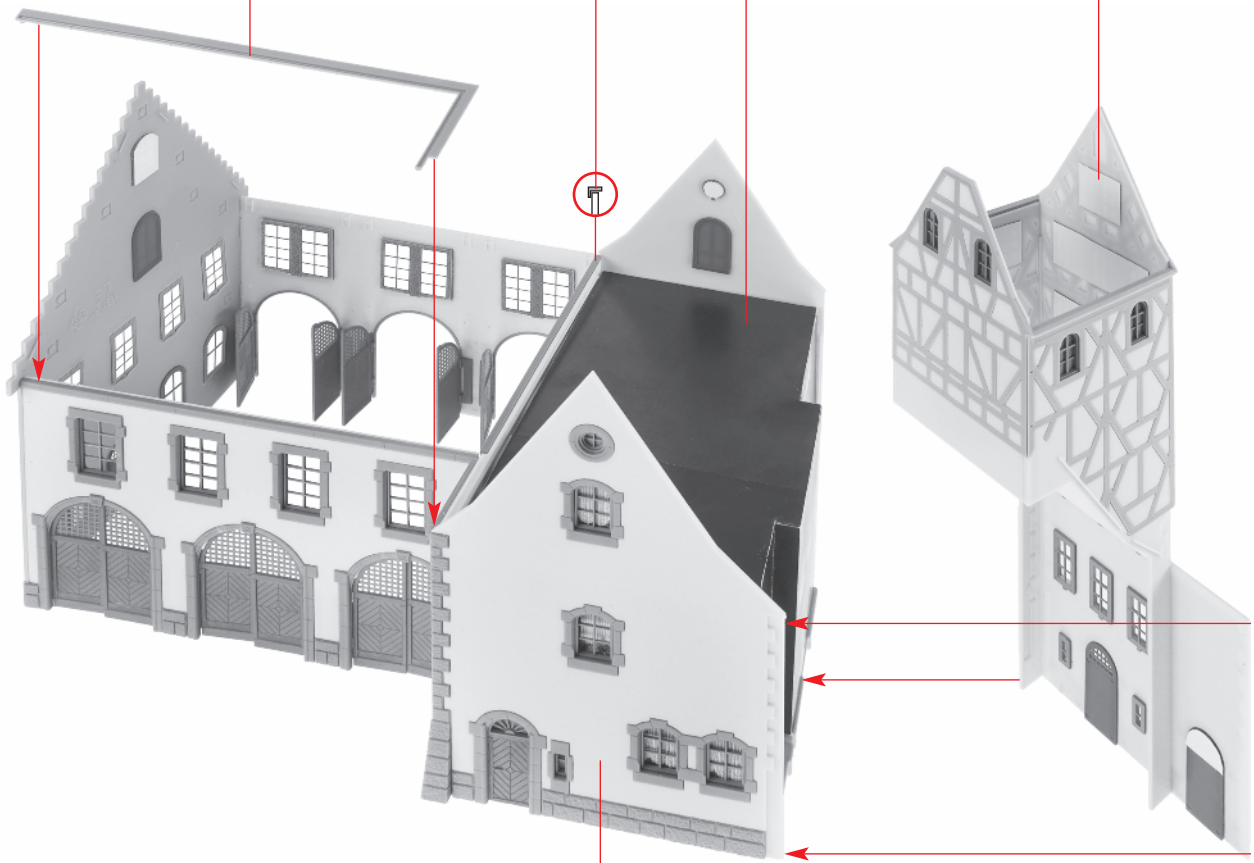

j

z

17/12

17/7

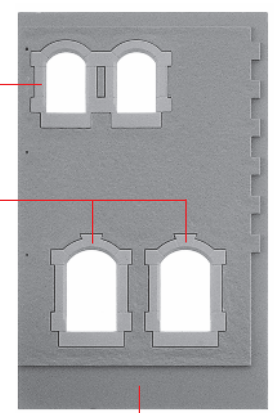

15/2

k

Fensterfolie
Window foil
Feuillet transparent
Vensterfolie



k

19/11

19/5

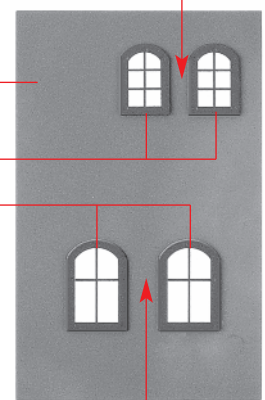

Fensterfolie
Window foil
Feuillet transparent
Vensterfolie

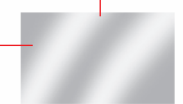

l

12

①

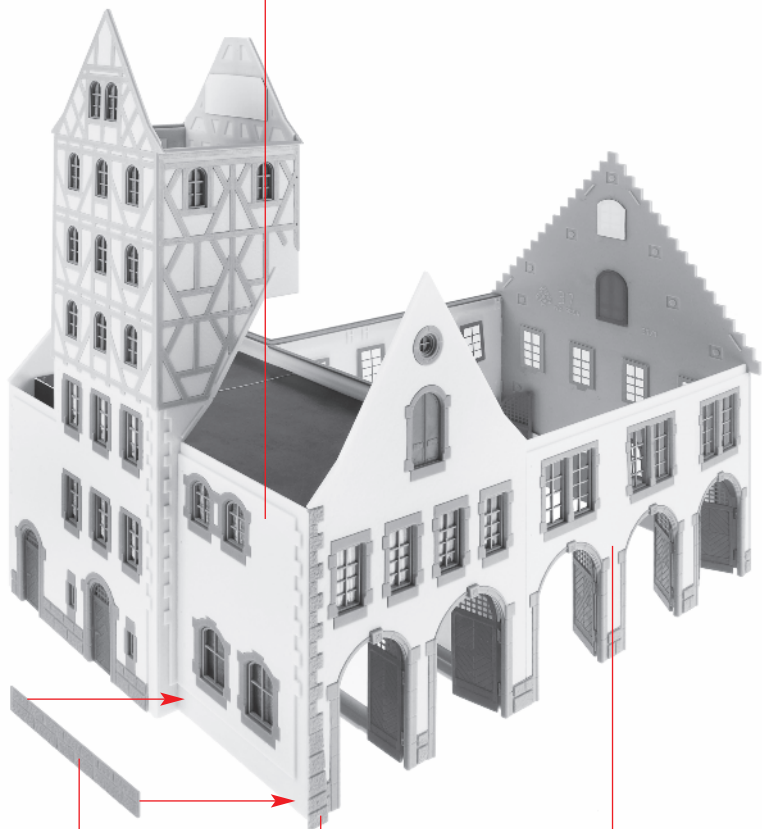

③

16/13

16/5

④

16/23

26/12

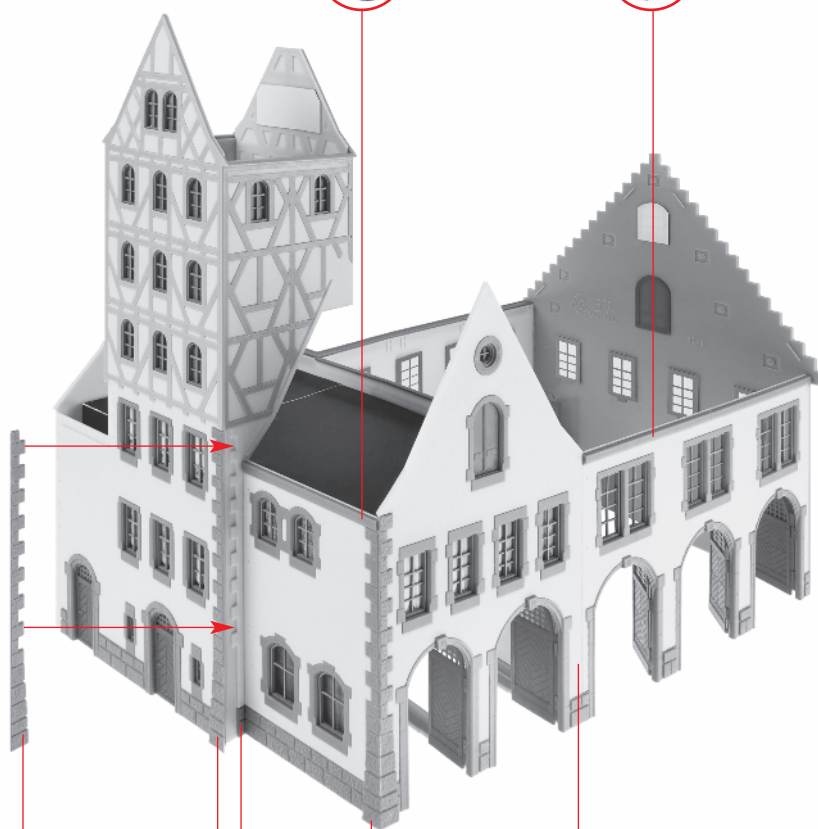

16/4

16/20

⑤

16/3

16/6

⑥

16/10 16/9

16/21

22/3

22/4

Papiermaske hier kleben
 Papermask glue here
 Masque coller ici
 Masker **M14** hier lijmen

Mit Alleskleber kleben.
 Use all-purpose glue.
 Utiliser de la colle universelle.
 Met een universele lijm lijmen.

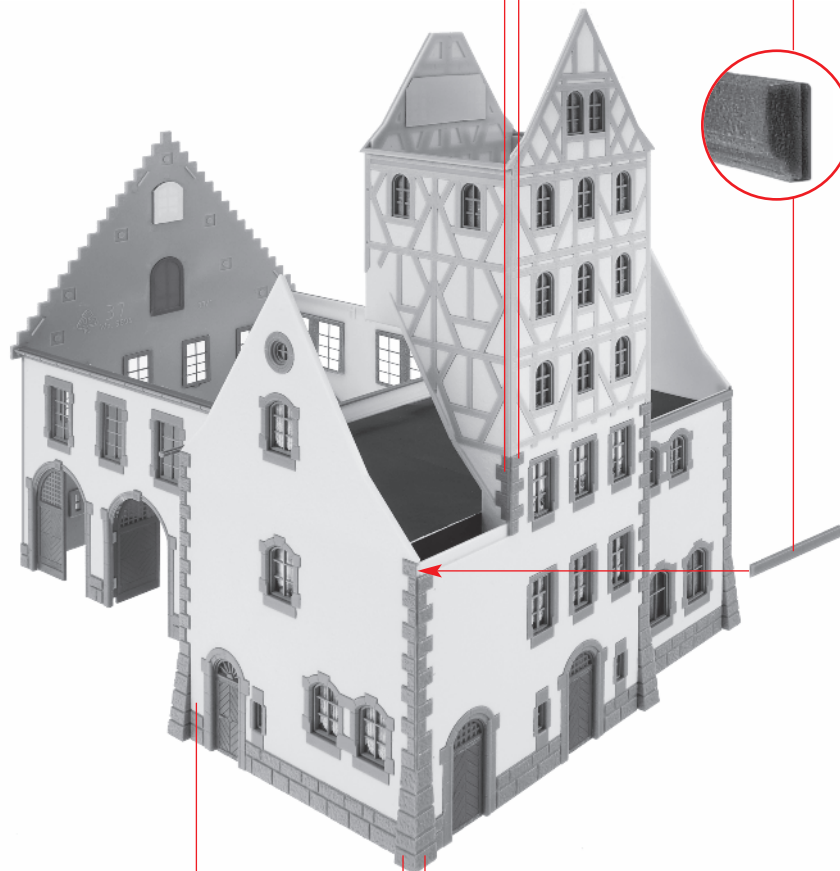

o

n

16/1 16/2

p

o

31/5 31/6

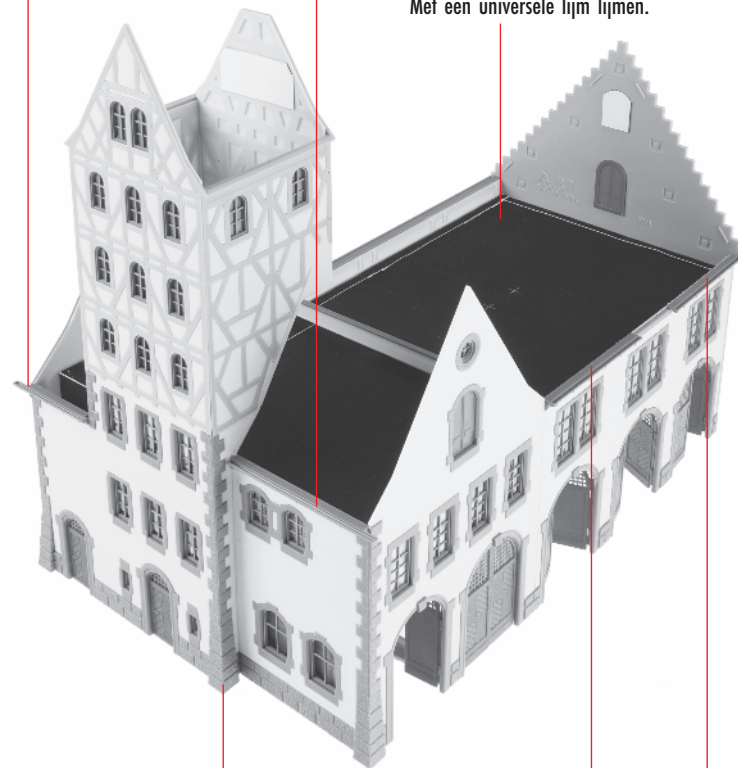

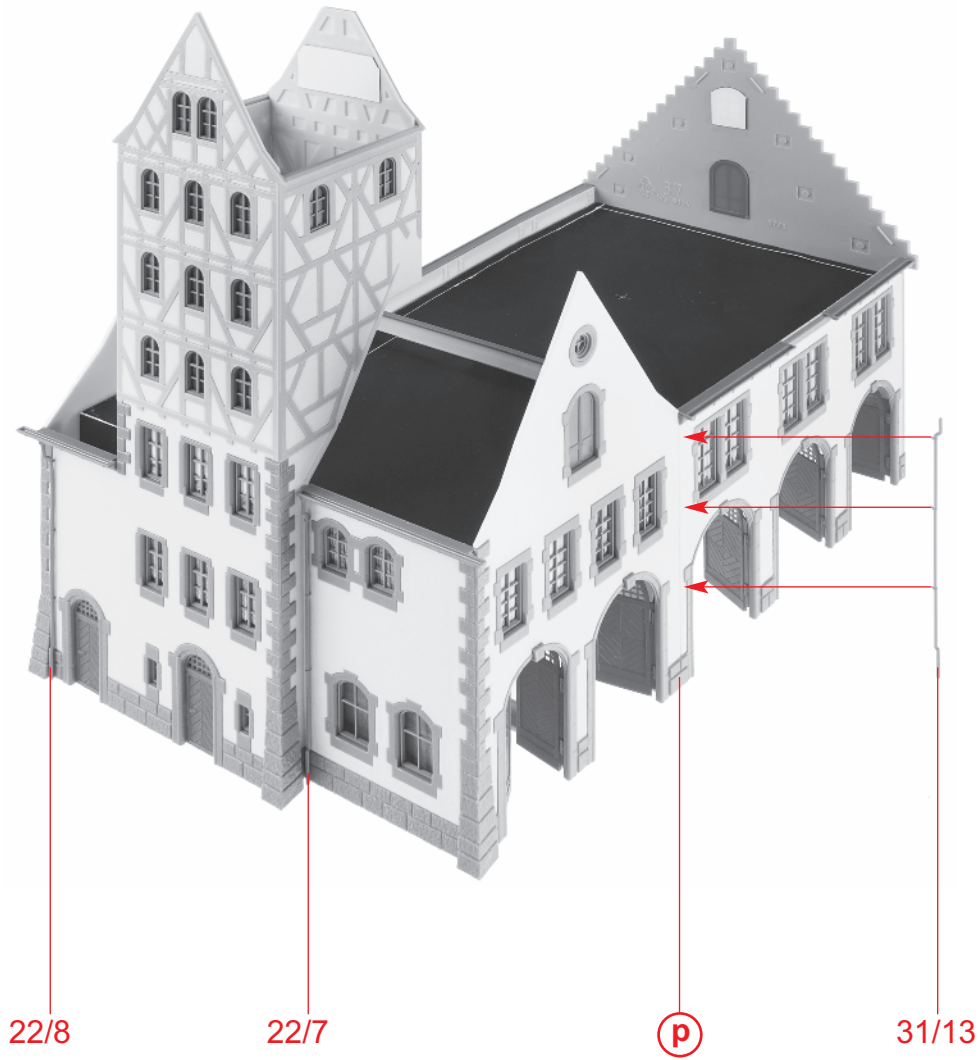

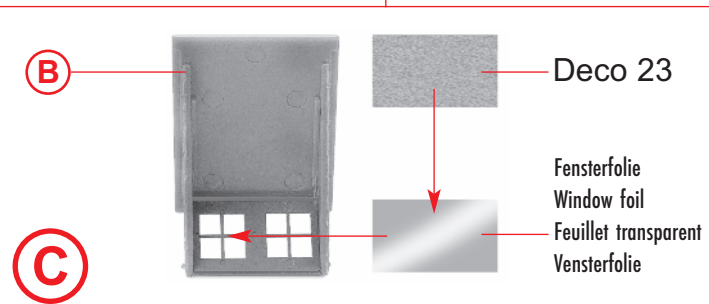
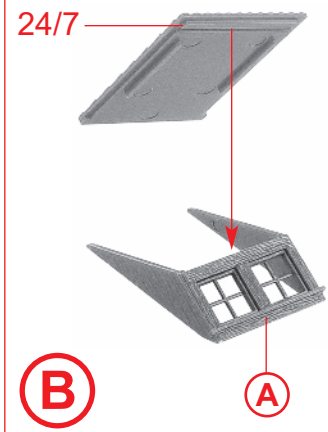
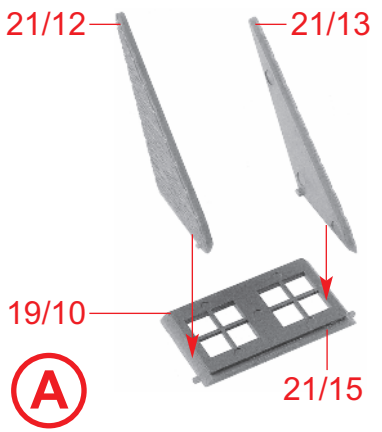
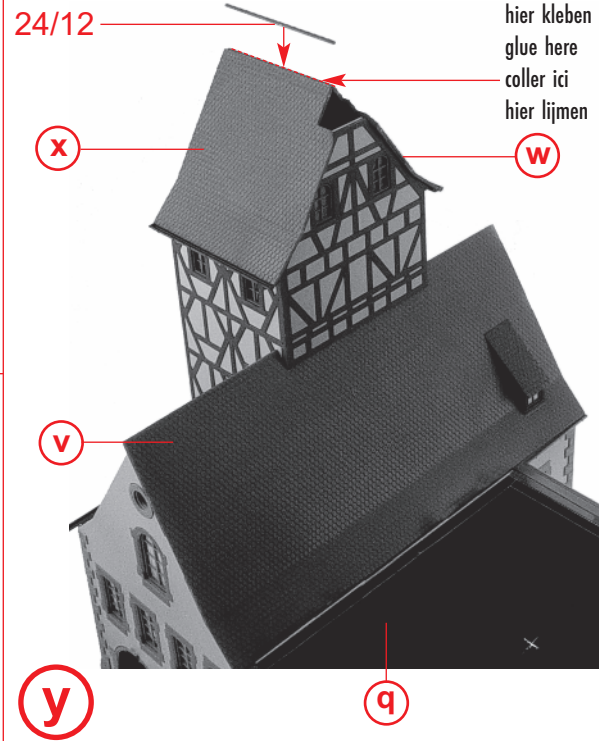
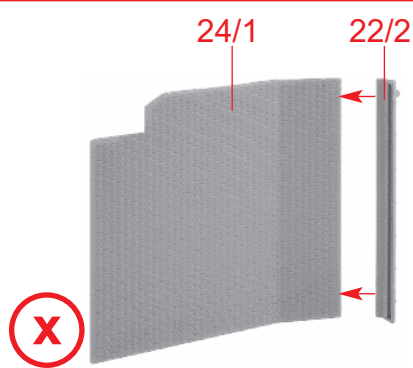
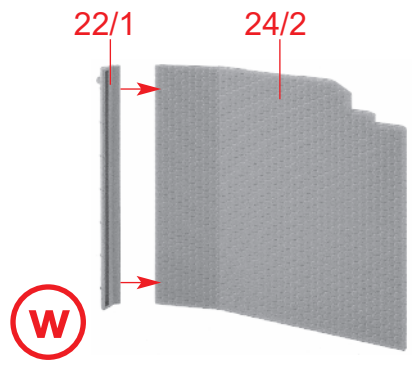
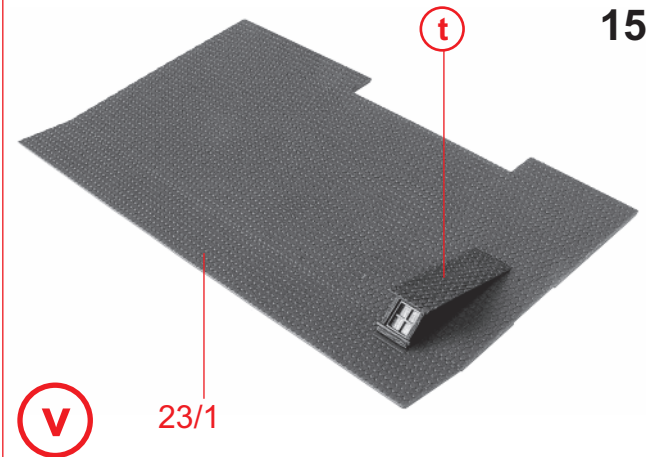
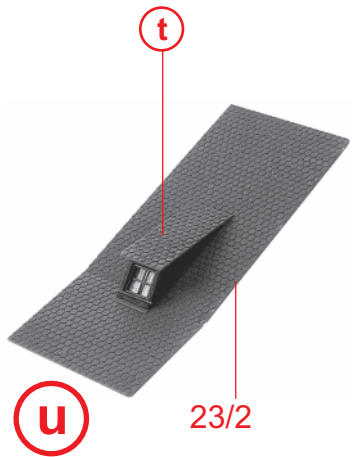
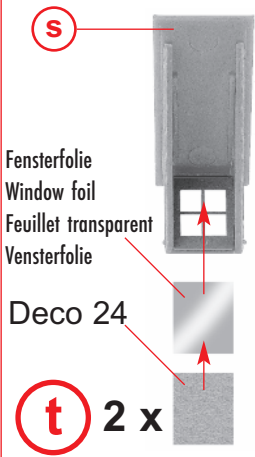
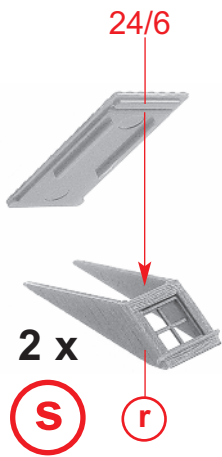
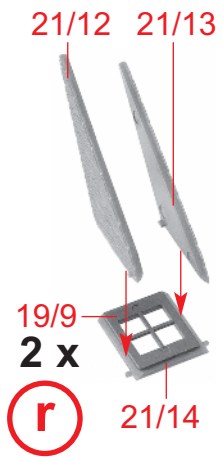

16

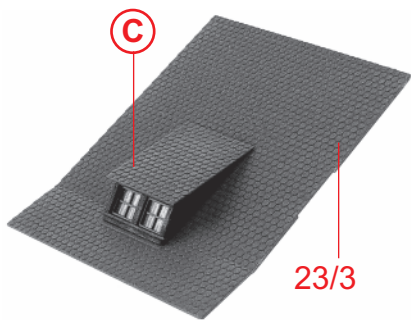

D

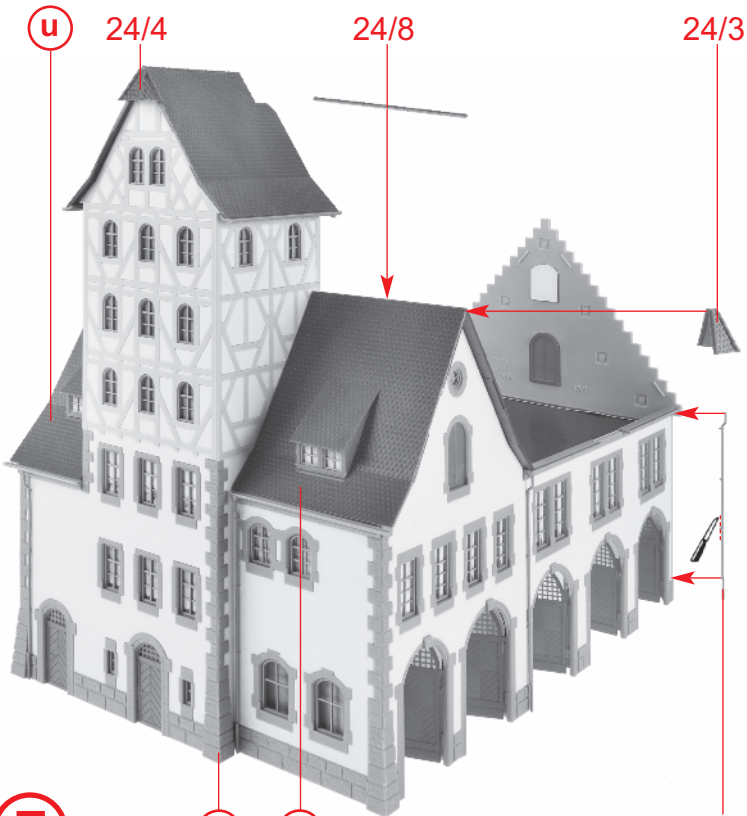

E

y

D

22/7

F

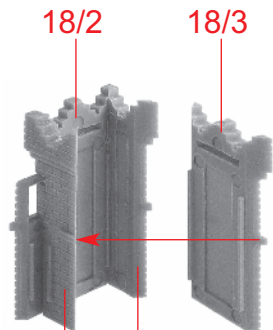

G

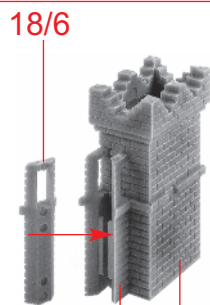

H

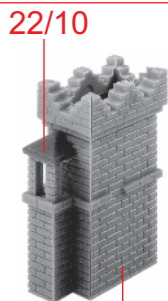

G

I

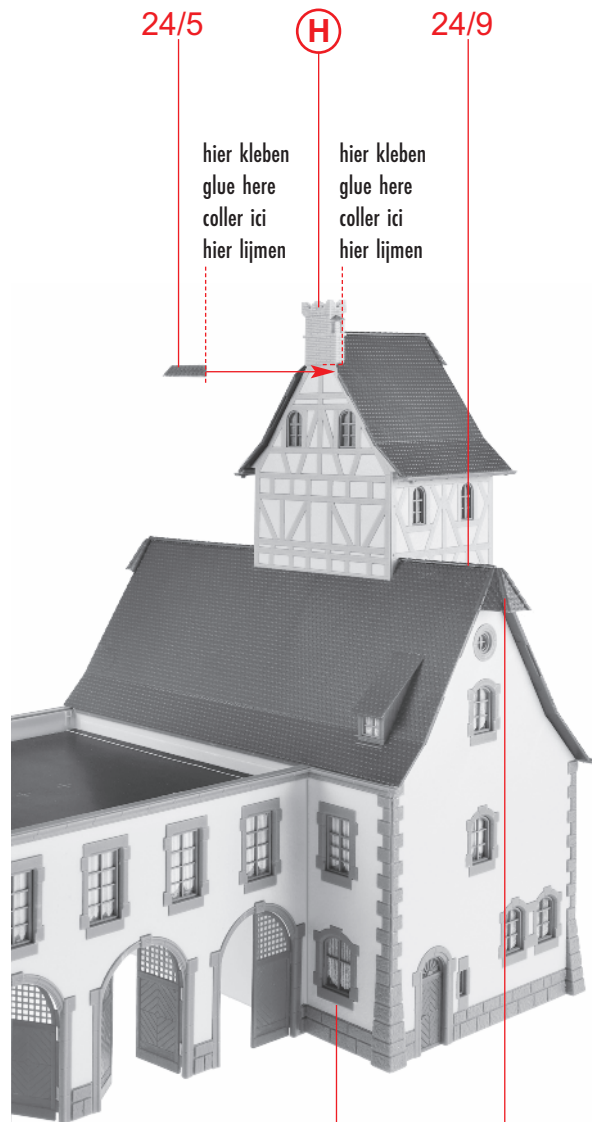

E

24/3

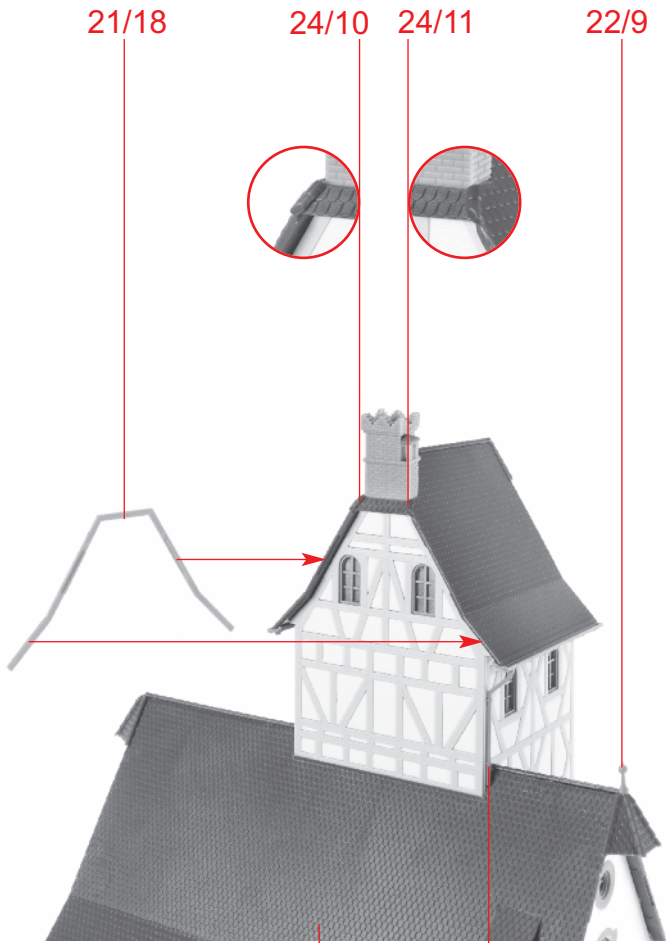

J

I

22/6

K

J

21/20

21/19

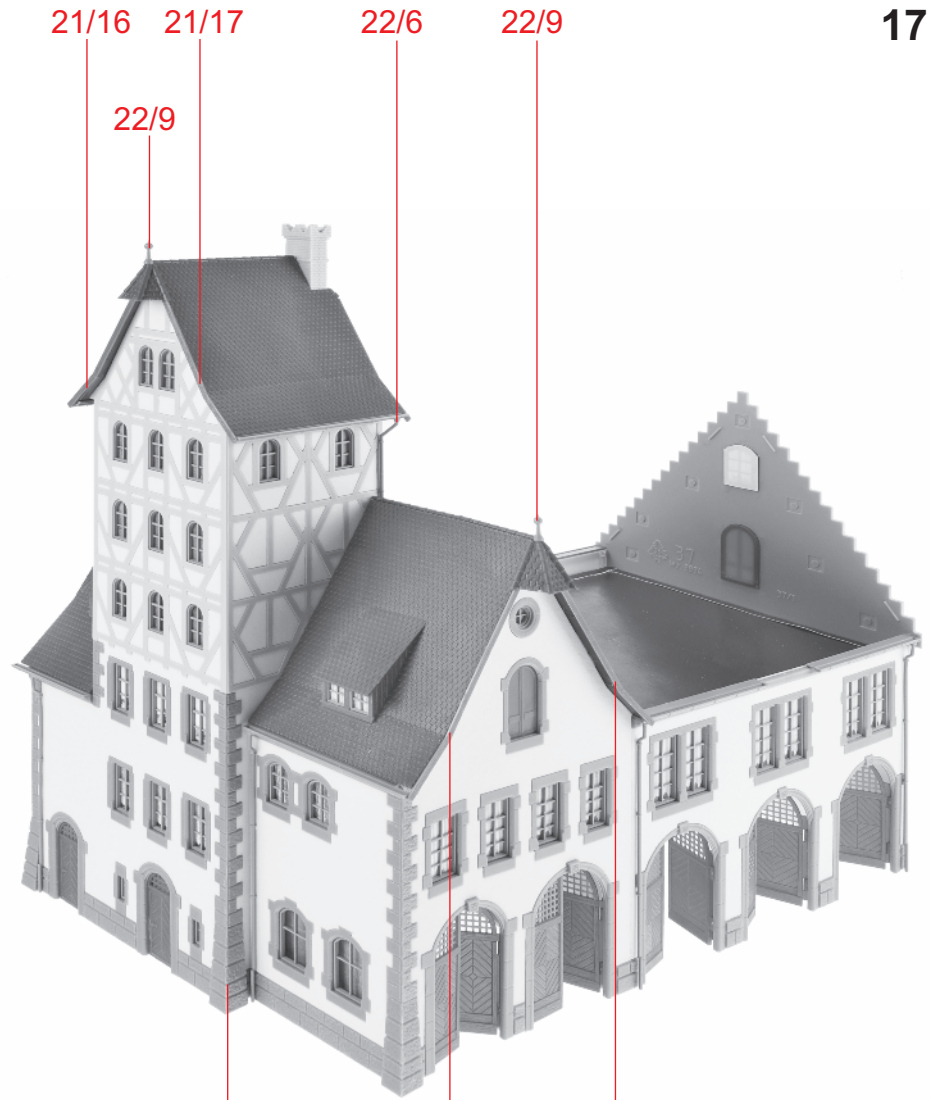

18

Deco 28

Fensterfolie
Window foil
Feuillet trans.
Vensterfolie

29/3
30/4

5 x

(L)

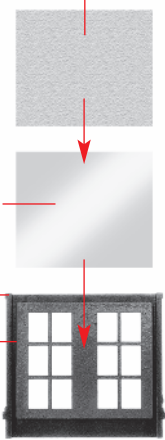

29/14

5 x

(M)

25/6

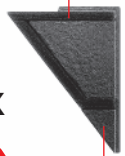

(N)

(M)

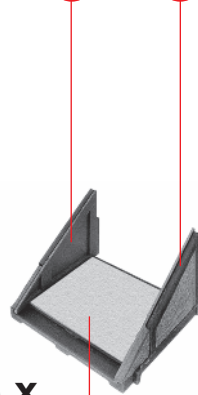

29/8

29/9

5 x

(P)

(O)

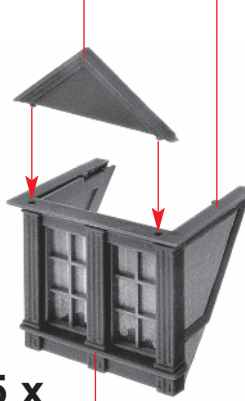

33/4

5 x

(Q)

33/3

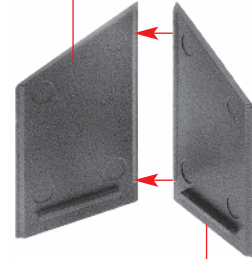

(Q)

5 x

(R)

(P)



Deco 29

Fensterfolie
Window foil
Feuillet trans.
Vensterfolie

30/3

(S)

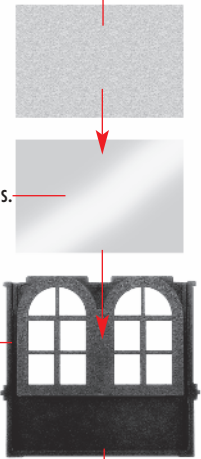

29/13

(T)

25/5

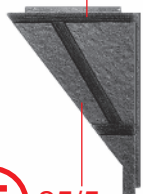

(U)

(T)

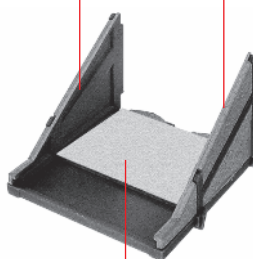

29/10

29/11

(W)

(V)

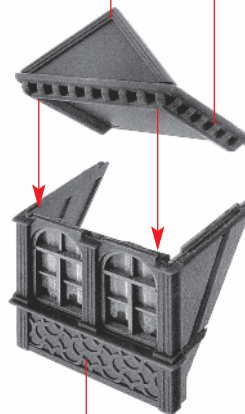

33/2

(X)

33/1

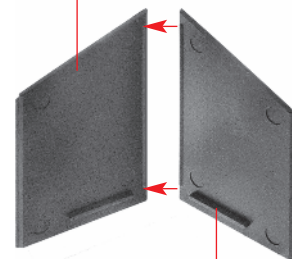

(X)

(Y)

(W)



29/2

25/4

(V)

(S)

Deco 30

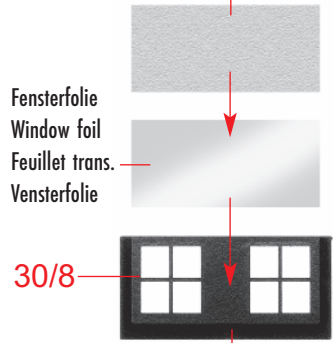

a 2 x 29/1

33/5

a

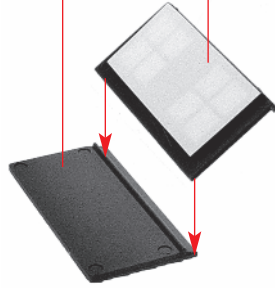

b 2 x

R

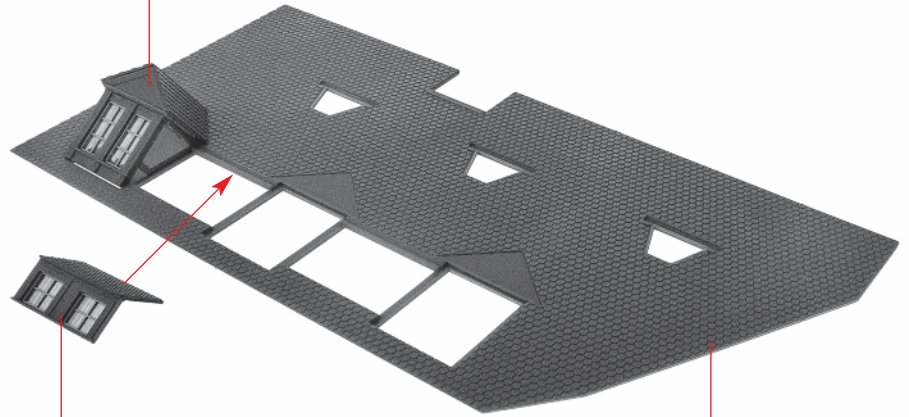

c **b**

32/2

28/10 28/8 28/9

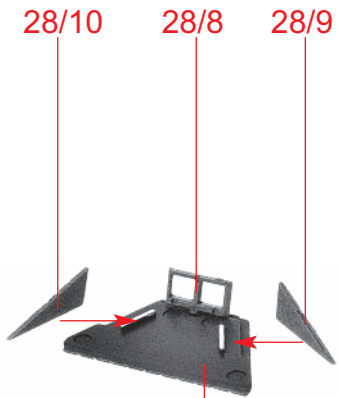

d 6 x 33/6

Deco 31

Fensterfolie
Window foil
Feuille transparent
Vensterfolie

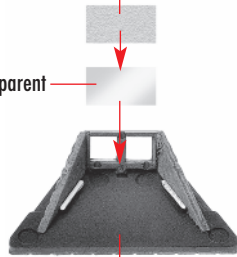

e 6 x **d**

R

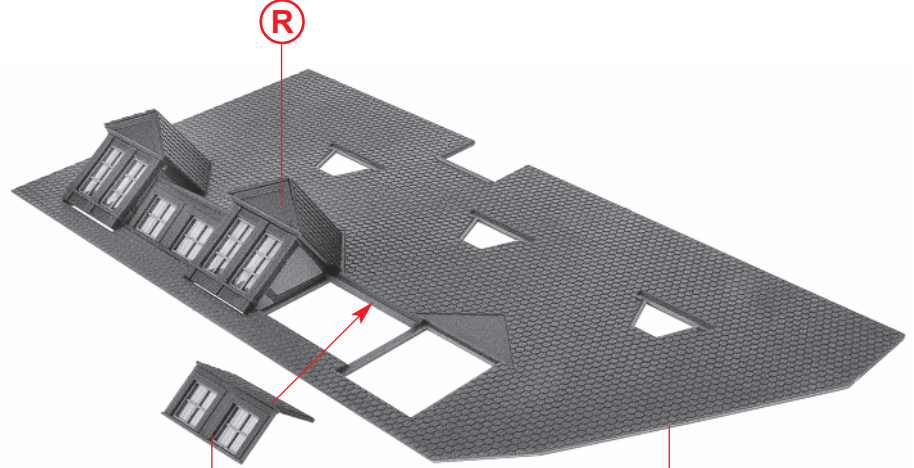

f **b**

c

20

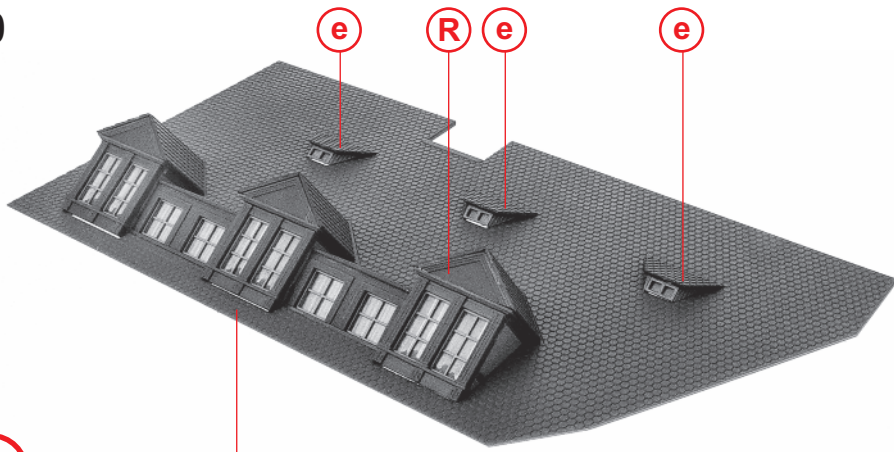

g

f

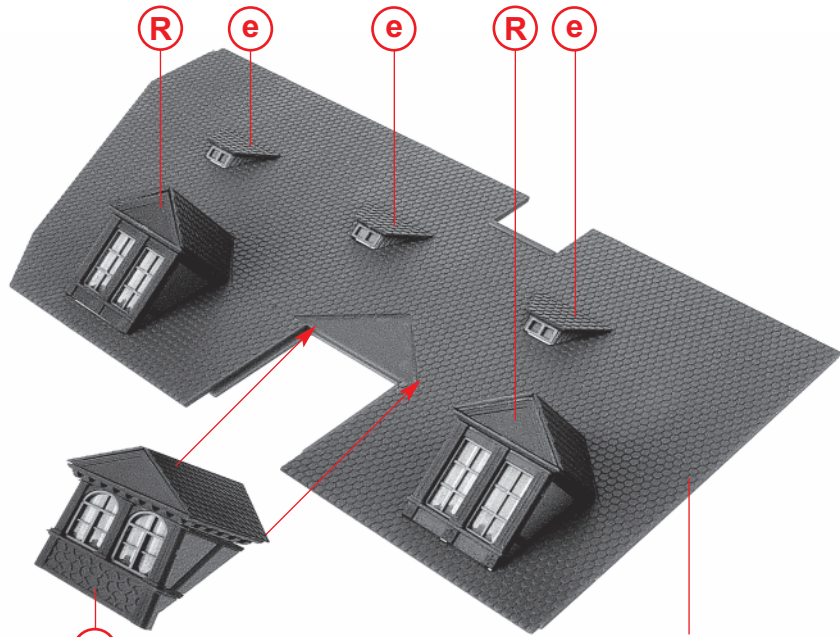

h

Y

32/1

28/4

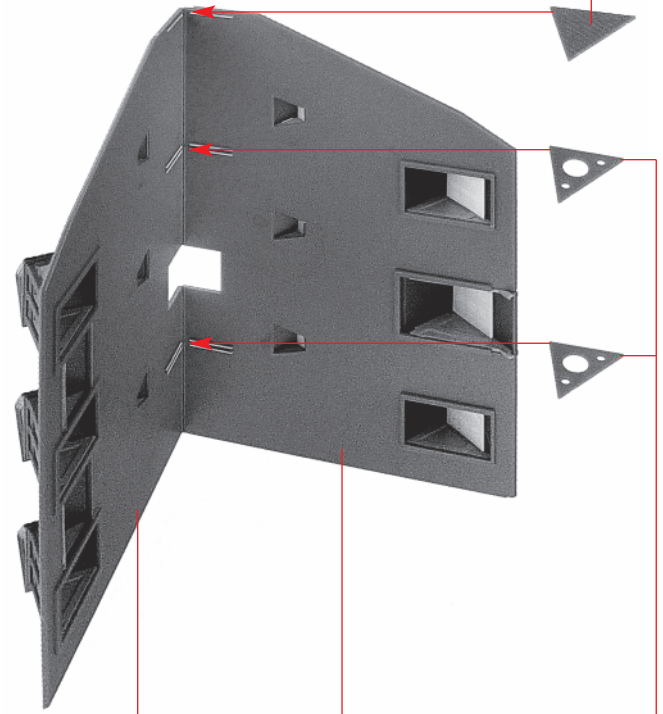

i

g

h

32/3

33/7 33/10 33/9 33/7 33/8 33/7

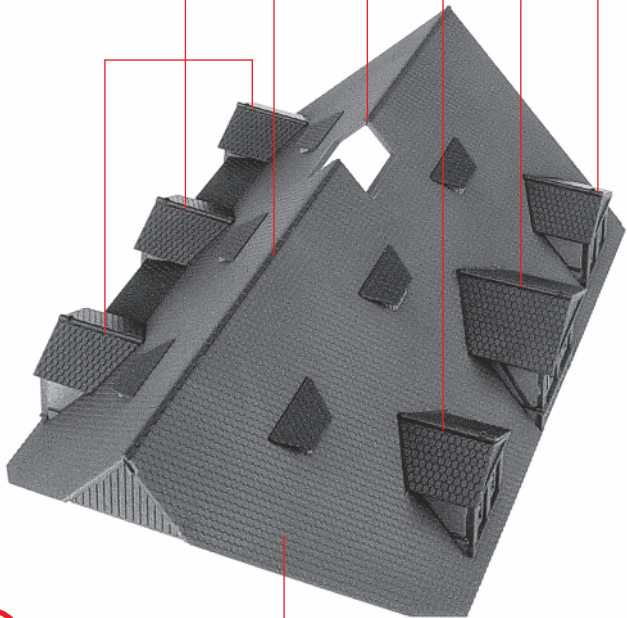

j

i

31/7 31/8 31/7

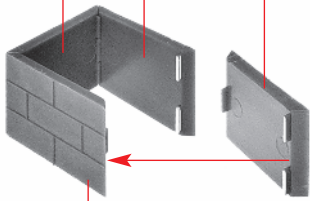

k

31/8

31/9 31/9

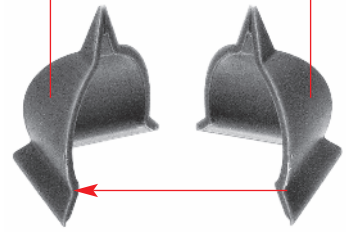

l

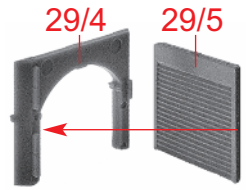

29/4

29/5

m

4 x

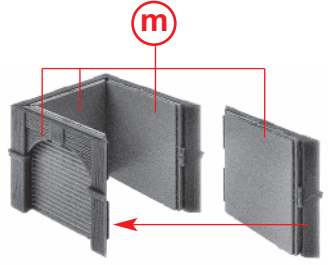

n

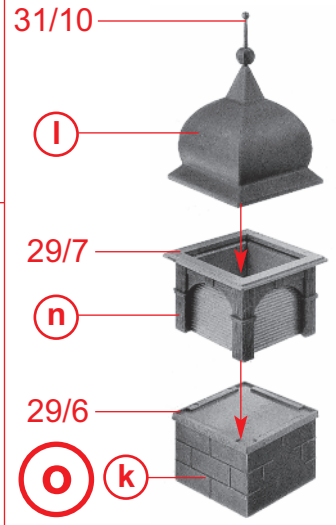

l

29/7

n

29/6

o

k

o

31/11

31/11

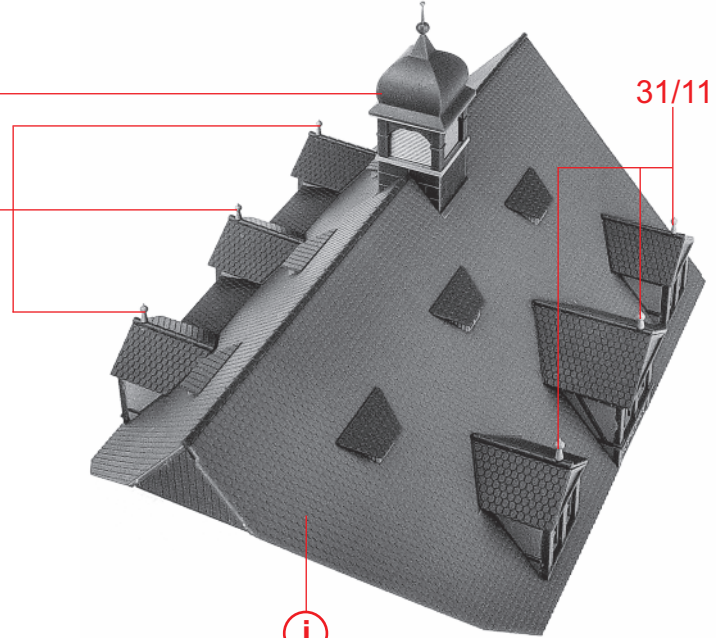

p

j

31/12

p

nicht kleben
do not glue
ne pas coller
niet lijmen

31/12

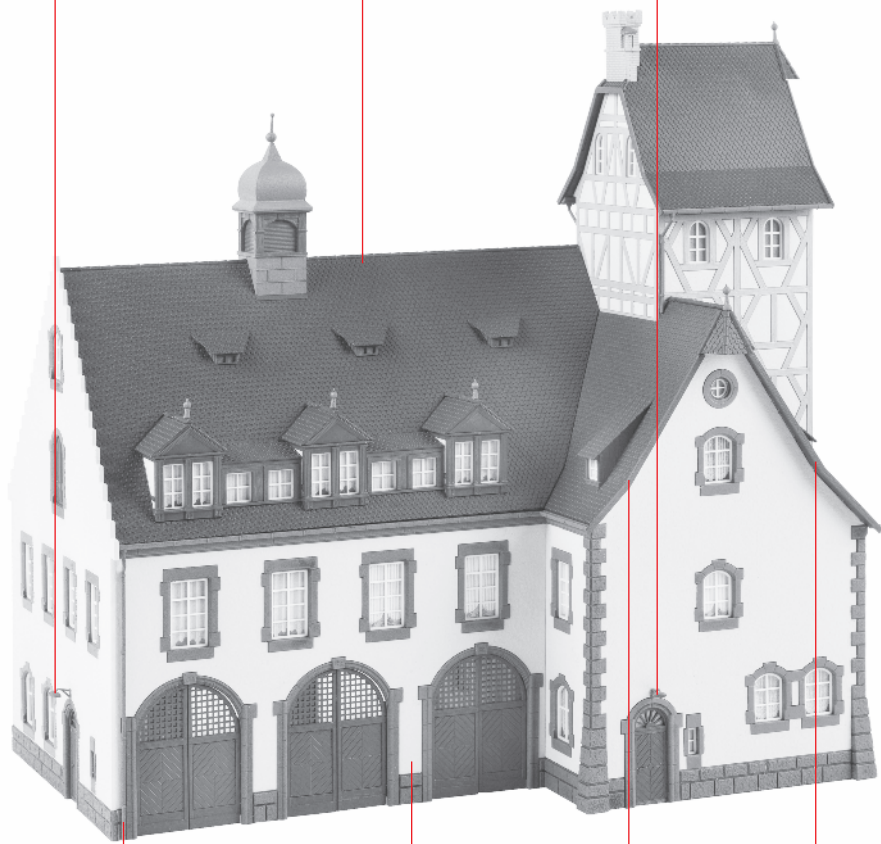

31/13

K

21/20

21/19

q

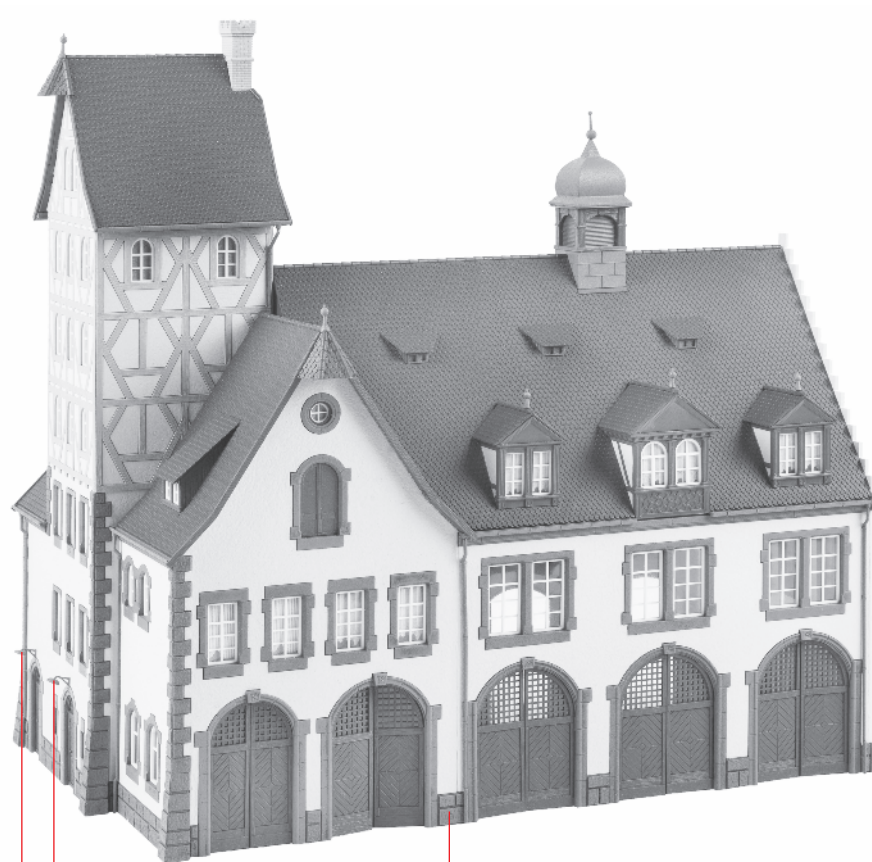

r

31/12

q

Modellbau leicht gemacht

Klebstoffe für den Profi-Modellbauer



170490

SUPER-EXPERT

25 g

Seit über 10 Jahren werden die FALLER EXPERT-Klebstoffe angeboten. Dieser Klebstoff für den Profi reagiert schneller, klebt schneller und dauerhafter. Mit Spezialkanüle und Kanülenschutzkappe.



170492

EXPERT

25 g

Dieser Klebstoff wird nach einer neuen Rezeptur hergestellt, das sorgt für optimale Klebergebnisse. Die Spezialkanüle ermöglicht eine besonders feine Klebstoffdosierung. Der Klebstoff kann in kleinsten Punkten, auch an schwer zugänglichen Stellen, auf die zu klebenden Teile aufgetragen werden.



170500

Modellbaukleber

10 g

für blitzschnelle Klebearbeiten. Dieser Sekundenkleber (Cyanacrylat) besitzt verbesserte Klebeeigenschaften, fließt in kleinste Spalten und neigt weniger zum Kriechen. Damit lassen sich fast alle Klebeverbindungen herstellen. Kühl und dunkel lagern.