

BAHNHOF »SCHIERKE«



»SCHIERKE« STATION

GARE DE »SCHIERKE«

STATION »SCHIERKE«

Art. Nr. 110136

D Vor Beginn des Bastelns sollten Sie sich mit den Teilerahmen und der Anleitung vertraut machen. Sollte es einmal vorkommen, dass ein Teil im Bausatz fehlt, kreuzen Sie bitte das fehlende Teil in der Anleitung an und schicken Sie diese bitte an Fa. Gebr. FALLER GmbH, Abt. Kundendienst, kundendienst@faller.de, Kreuzstraße 9, 78148 Gütenbach. Sie erhalten dann umgehend Ersatz. Es kann vorkommen, dass bei einem Bausatz Einzelteile übrig sind. Bitte behandeln Sie die Holz- und Kartenteile äußerst vorsichtig und sorgfältig. Die Teile sind stoß- und feuchtigkeitsempfindlich. Kontrollieren Sie den Bausatz vor Beginn auf Vollständigkeit und Unversehrtheit der Teile. Trennen Sie die einzelnen Teile vorsichtig mit einem scharfen Bastelmesser aus dem Teilerahmen. Beachten Sie, dass die Teile bereits nach kurzer Zeit gut aneinander haften und nur schwer wieder voneinander getrennt werden können.

GB Before you start you should familiarize yourself with the parts frame and the instruction manual. If a part should be missing then please mark the missing part in the instruction manual and send it to Gebr. FALLER GmbH, Abt. Kundendienst, kundendienst@faller.de, Kreuzstrasse 9, D-78148 Gütenbach. You will then immediately receive a replacement part. It may happen, that in a kit single parts are not being used. Please treat the parts very carefully and accurately. The parts are shock-sensitive and moisture-sensitive. Check the kit for completeness of contents and intactness of parts. Carefully separate the parts with a hobby knife from the parts frame. Kindly note, that the parts already stick together after short time and that they can hardly be separated again.

F Avant de commencer le montage, veuillez vérifier les grappes de pièces et consulter la notice de montage. Si une des pièces est manquante, marquez la d'une croix dans la notice de montage et renvoyez nous cette dernière avec vos coordonnées à Fa. Gebr. FALLER GmbH, Abt. Kundendienst, Kreuzstraße 9, D-78148 Gütenbach ou par e-mail à kundendienst@faller.de. Nous vous ferons parvenir une pièce de remplacement. Dans certains kits, il est possible que certaines pièces ne soient pas utilisées. Veuillez manipuler les pièces en bois et carton avec prudence et soin. Les pièces sont sensibles aux chocs et à l'humidité. Avant de commencer l'assemblage, vérifiez que toutes les pièces sont présentes et en bon état. Prélevez soigneusement les pièces du cadre, une par une, avec un couteau de modéliste à lame acérée. Notez que les pièces assemblées deviennent rapidement solitaires et qu'il est difficile de les séparer par la suite. Vérifiez bien la justesse des assemblages !

NL Voordat u met het bouwen van start gaat adviseren wij u de onderdelen te controleren en de bouwbeschrijving te bestuderen. Als het onverhoopt voorkomt dat een onderdeel in de bouwdoos mist of beschadigd is, kruis dan het desbetreffende onderdeel op de handleiding aan en stuur deze naar: Gebr. Faller GmbH, afd. Kundendienst, Kreuzstrasse 9, D-78148 Gütenbach. Mailen kan ook: kundendienst@faller.de. U ontvangt het gewenste onderdeel per omgaande. Het kan voorkomen dat u bij bepaalde bouwdozen onderdelen overhoudt. Behandel de houten en kartonnen onderdelen s.v.p. voorzichtig en zorgvuldig. De onderdelen kunnen makkelijk beschadigd raken en zijn gevoelig voor vocht. Snijd de onderdelen voorzichtig met een scherp mes uit het onderdelen raamwerk. Houd er s.v.p. rekening mee dat de onderdelen al na korte tijd vast aan elkaar hechten en moeilijk weer van elkaar gescheiden kunnen worden.

Für den Zusammenbau des Modells empfehlen wir folgende FALLER-Artikel: Art. Nr. 170494 + 170687 (liegen nicht bei).

For the assembly of the kit we recommend following FALLER products: Art. Nr. 170494 + 170687 (not included).

Pour l'assemblage du modèle, nous vous recommandons les articles FALLER suivants: Art. Nr. 170494 + 170687 (non jointe).

Om dit model te bouwen adviseren wij de volgende FALLER producten: Art. Nr. 170494 + 170687 (niet bijgevoegd).

ajkids.com
planes, trains automobiles

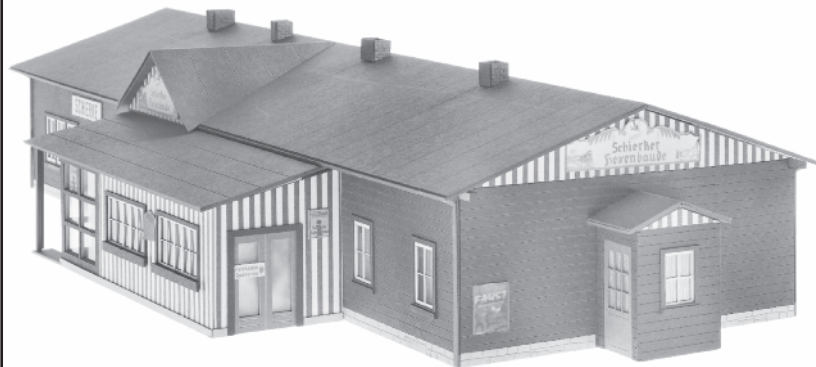

Inhalt	Spritzlinge	1	1	x	4	1	x	7	1	x	10	1	x	13	1	x
Contens	Sprues	2	1	x	5	1	x	8	1	x	11	1	x	14	1	x
Contenu	Moulesges	3	1	x	6	1	x	9	1	x	12	1	x	15	1	x
Inhoud	Gietstukken															

Sa. Nr. 110 136 1



Art. Nr. 170494
FALLER-EXPERT LASERCUT

Dieser Klebstoff verbindet Holz-, Karton-, Styropor- und Decorflechteile miteinander. Ideal für den Bau von Laser-Cut-Modellen geeignet.

This glue joins wood, cardboard, Styrofoam, and decorating parts. Ideal for building Laser-Cut-Models.

Cette colle relie les pièces en bois, carton, polystyrène deco-flex. Idéal pour la construction de modèles laser-cut.

Deze lijm verbindt houten, kartonnen, piepschuimen en decorfleex delen met elkaar. Ideaal geschikt voor het bouwen van laser cut modellen.

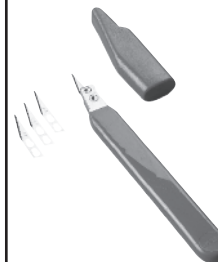

Art. Nr. 170687
FALLER-BASTELMESSER
wie es die Profi-Modellbauer für ihre Arbeit verwenden. Komplett mit 3 Ersatzklingen. Weitere Ersatzklingen erhalten Sie direkt über den FALLER-Kundendienst.

like the professional modellers use for their work. Complete with 3 spare blades. You can order additional spare blades directly via the FALLER customer service.

tout comme les constructeurs de modèles professionnels l'utilisent pour leur travail. Complet avec 3 lames de remplacement. D'autres lames de remplacement sont disponibles directement chez le service de clientèle de FALLER.

zoals het de profi-modellbouwers voor hun werk gebruiken. Compleet met 3 reservemesjes. Verdere reservemesjes verkrijgt u direct via de FALLER-klantenservice.

Fensterfolie

Die beiliegende Fensterfolie entsprechend der benötigten Größe ausschneiden und vorsichtig mit wenig Klebstoff auf die Rückseite der Fensterrahmen aufkleben.

Window foil

Cut the attached window foil according the illustrations and glue it carefully with a little glue to the rear side of the window frames.

Feuillet transparent pour fenêtres

Découper le feuillet transparent pour fenêtres inclus d'après l'illustration. Coller proprement avec un peu de colle sur la face arrière du cadre des fenêtres.

Vensterfolie

De meegeleverde vensterfolie conform de afbeeldingen uitknippen of uitsnijden en voorzichtig met een beetje lijm op de achterzijde van het raam plakken.

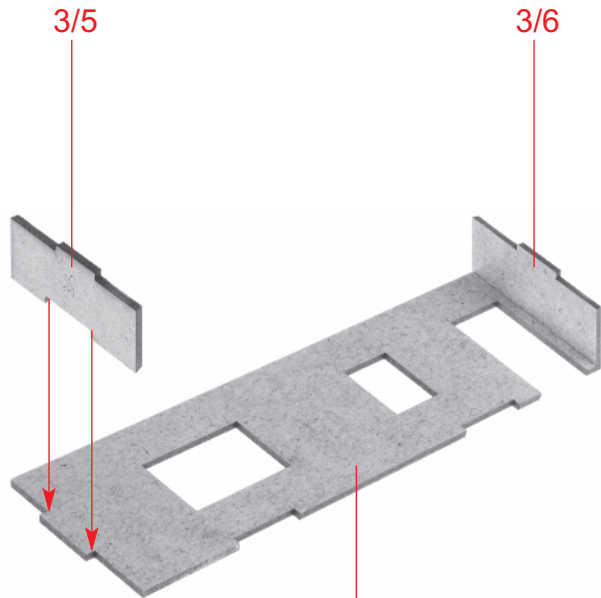

A

3/4

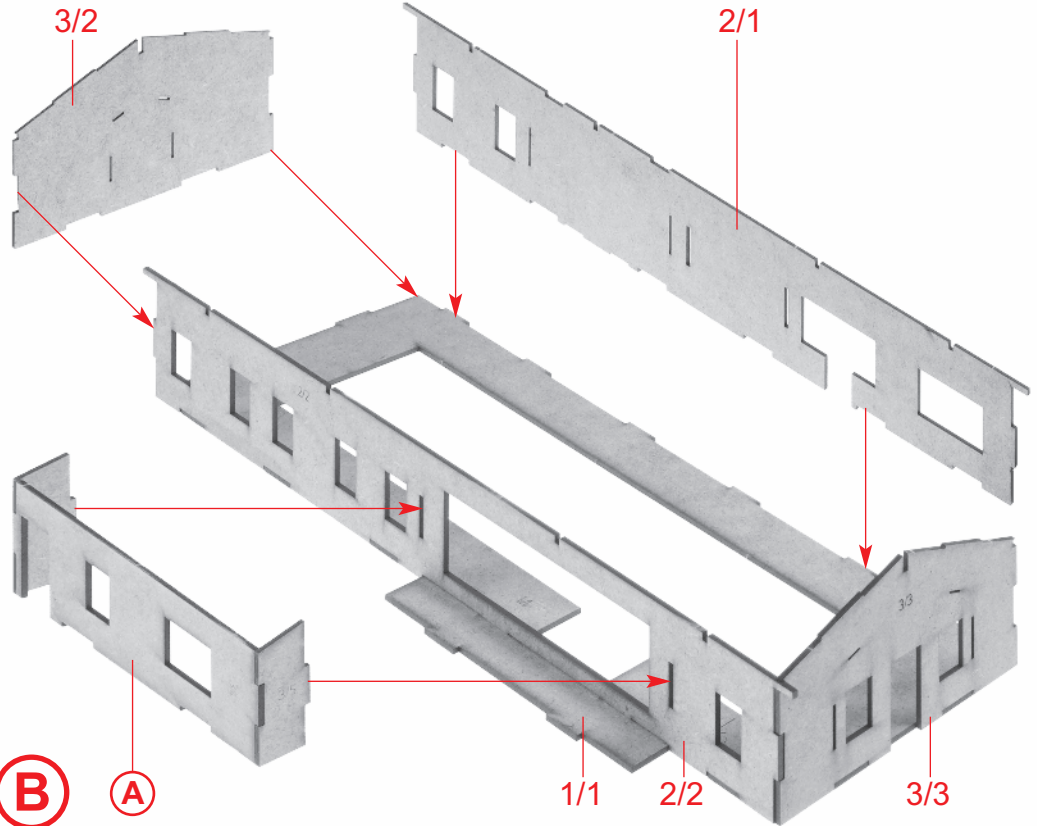

B

A

1/1

2/2

3/3

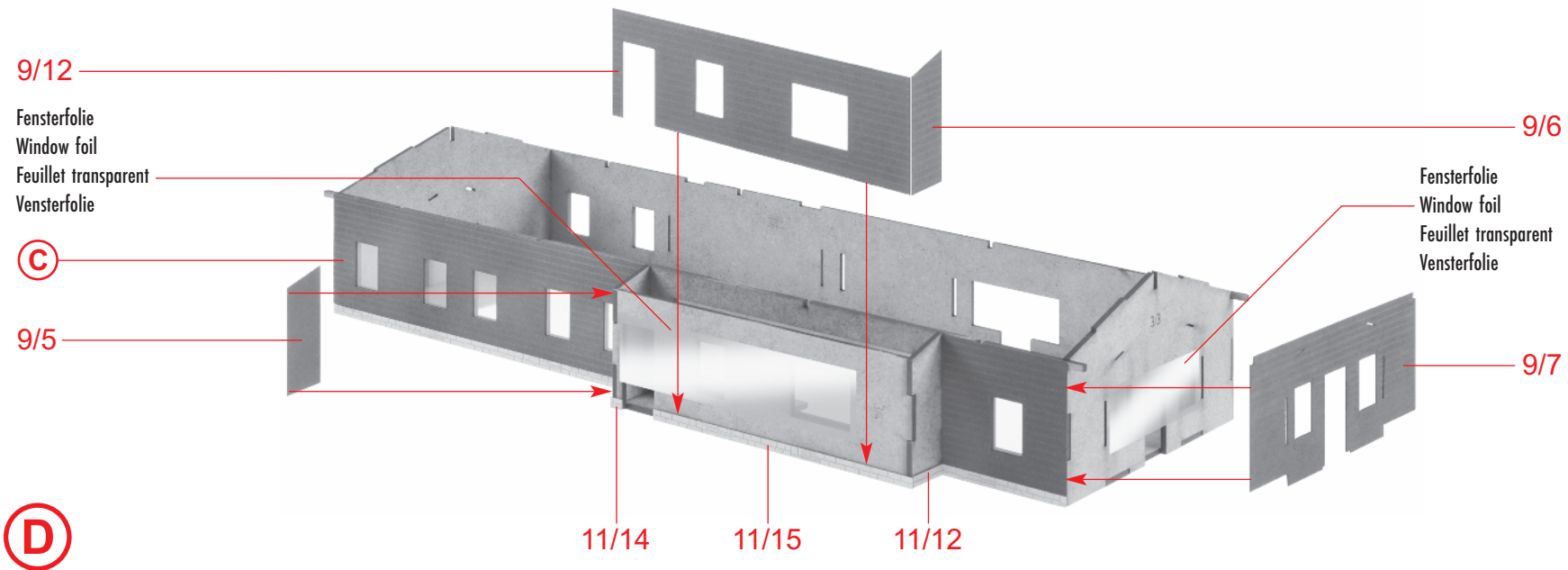
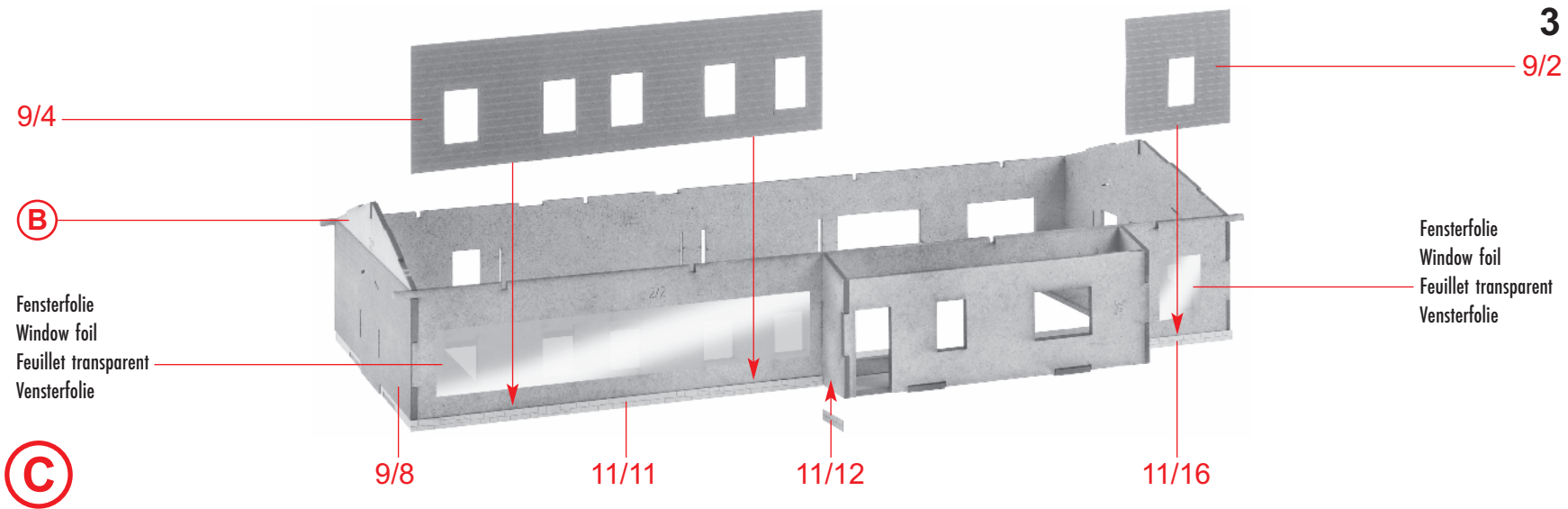

4

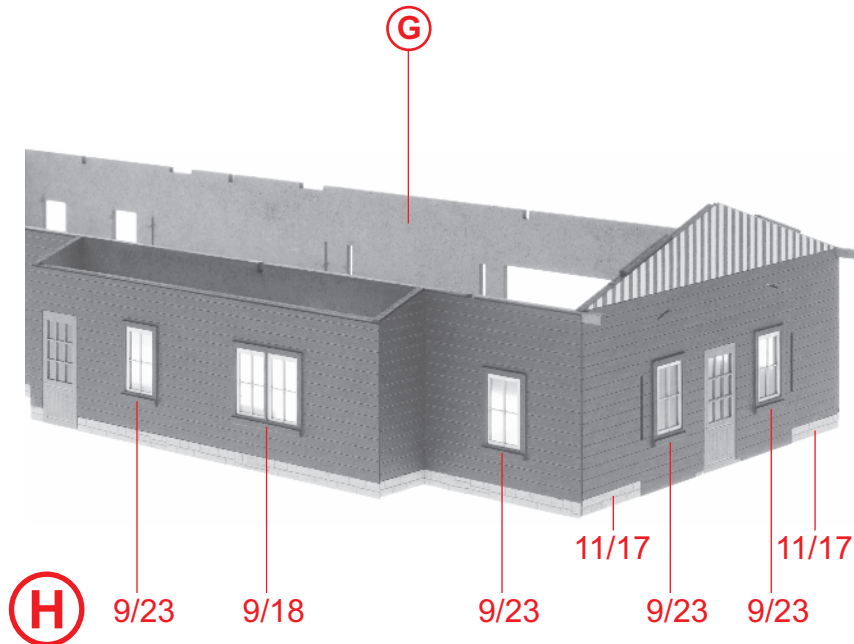
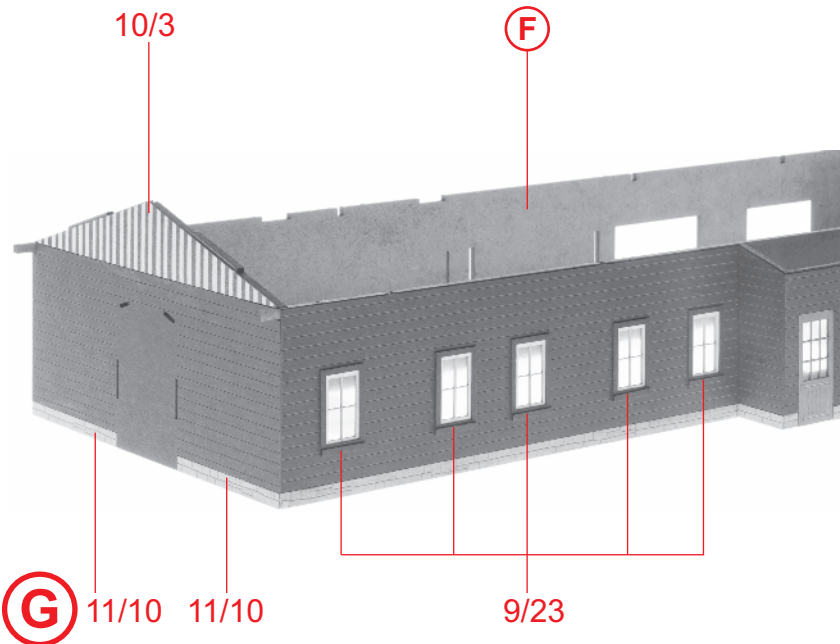
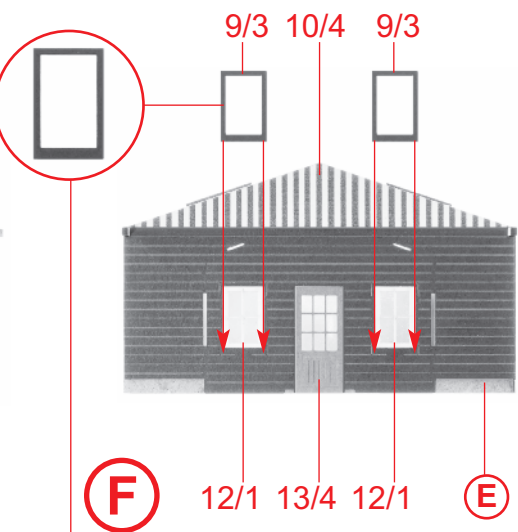
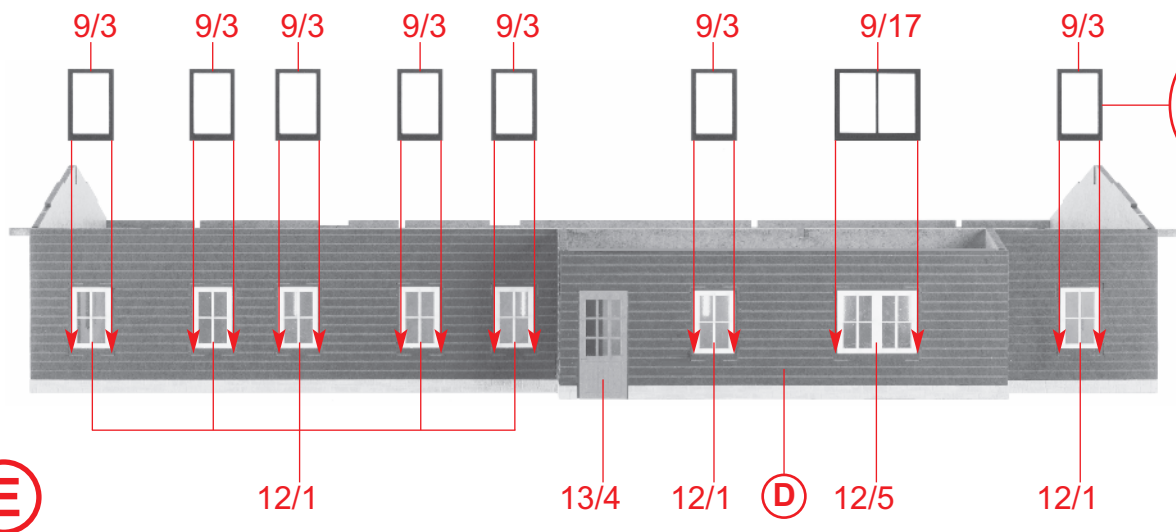

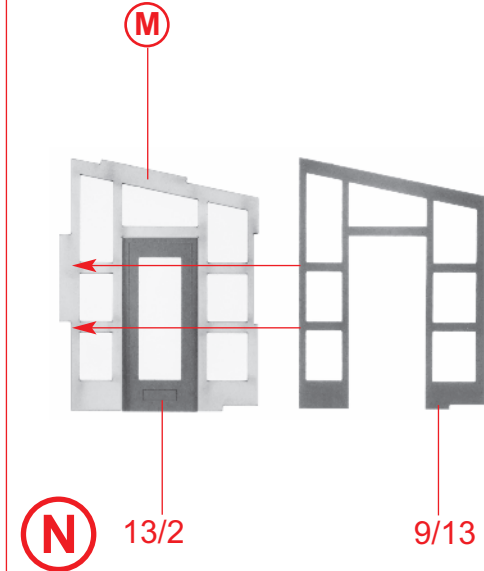
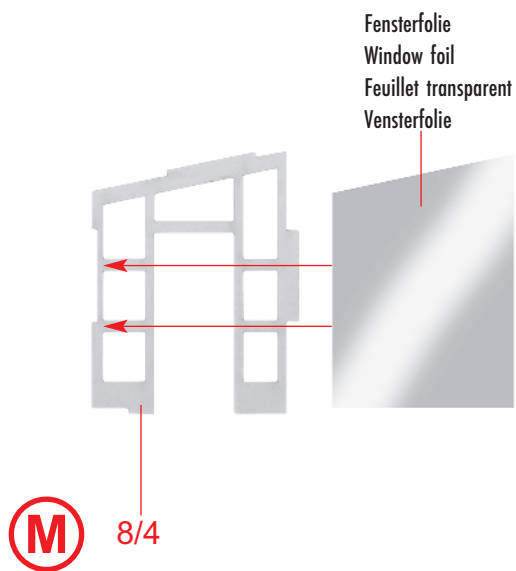
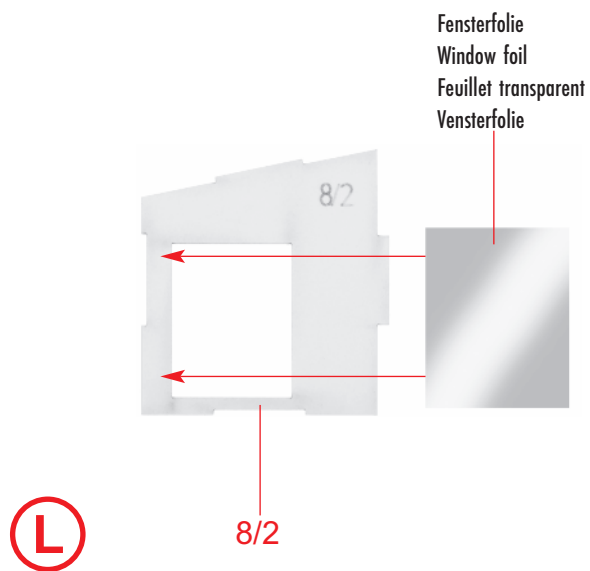
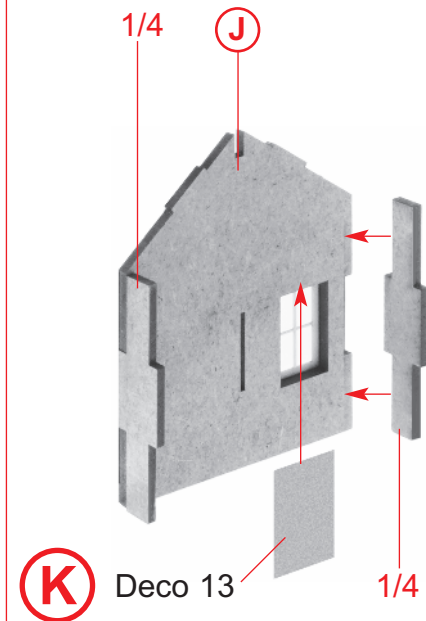
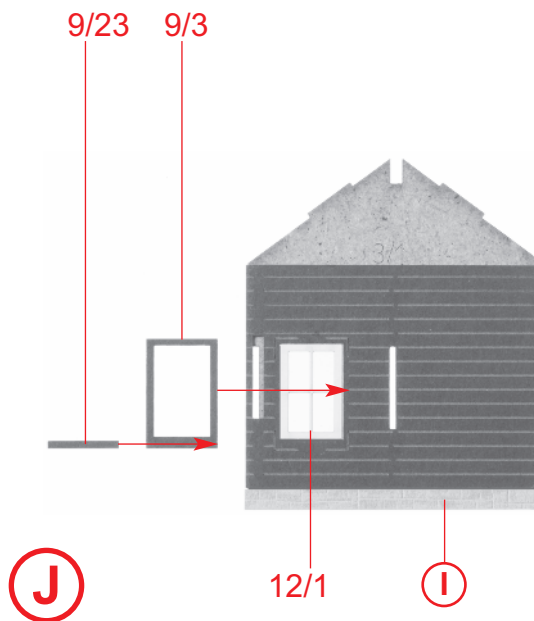
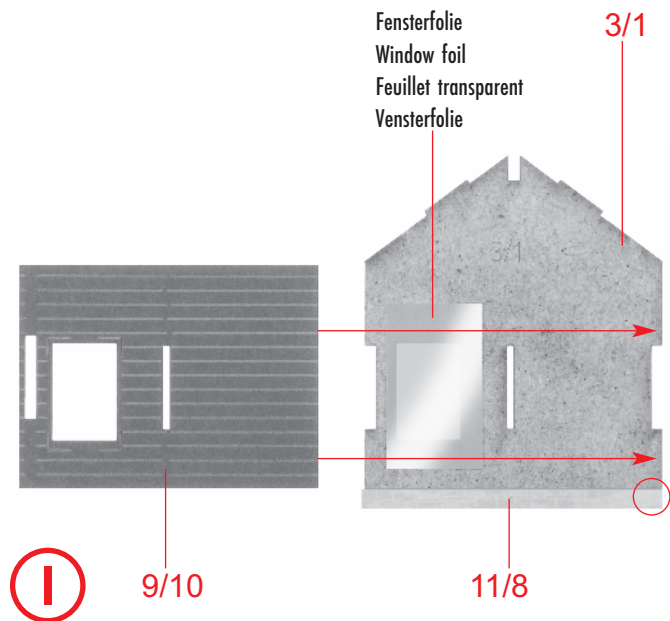

6

10/1

9/22

9/22

Fensterfolie
Window foil
Feuillet transparent
Vensterfolie

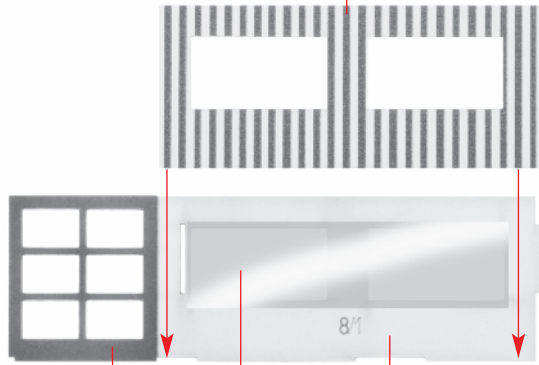

Fensterfolie
Window foil
Feuillet transparent
Vensterfolie

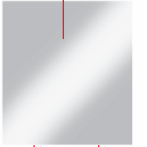
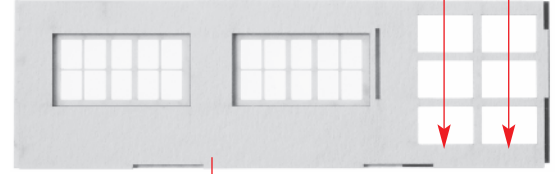
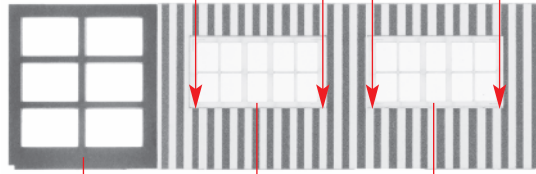

Ⓞ

9/14

8/1

Ⓟ

Ⓞ

12/3

12/3

Ⓞ

Ⓟ

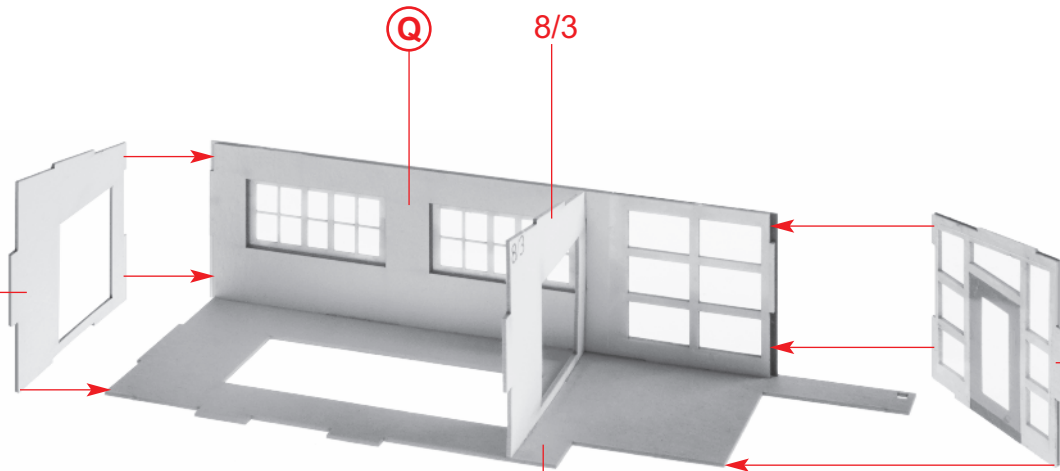

Ⓛ

Ⓞ

8/3

Ⓝ

7/1

Ⓟ

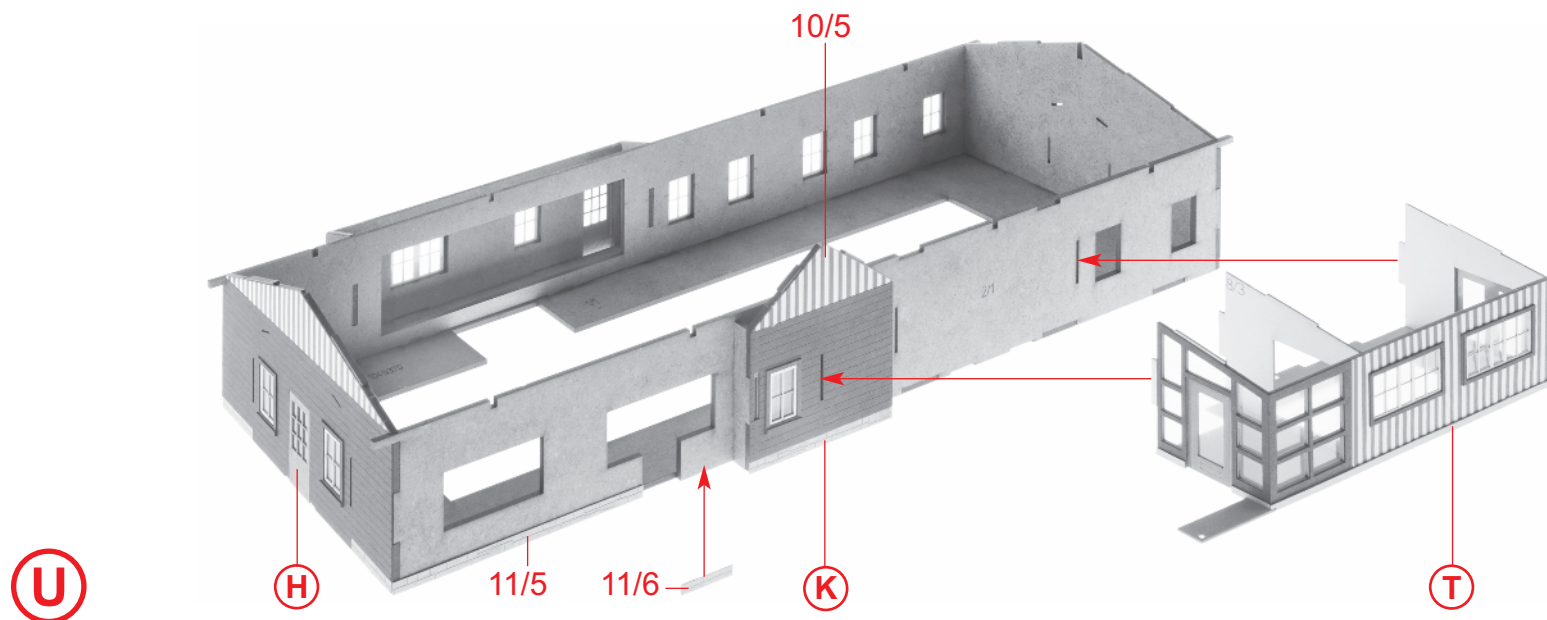
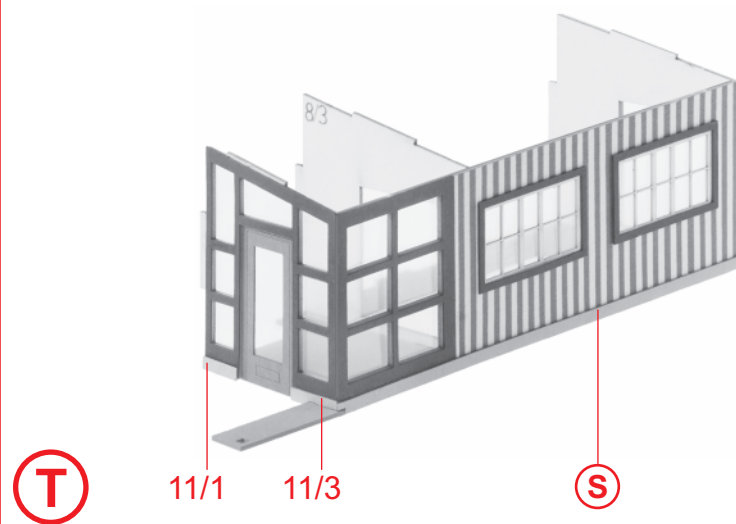
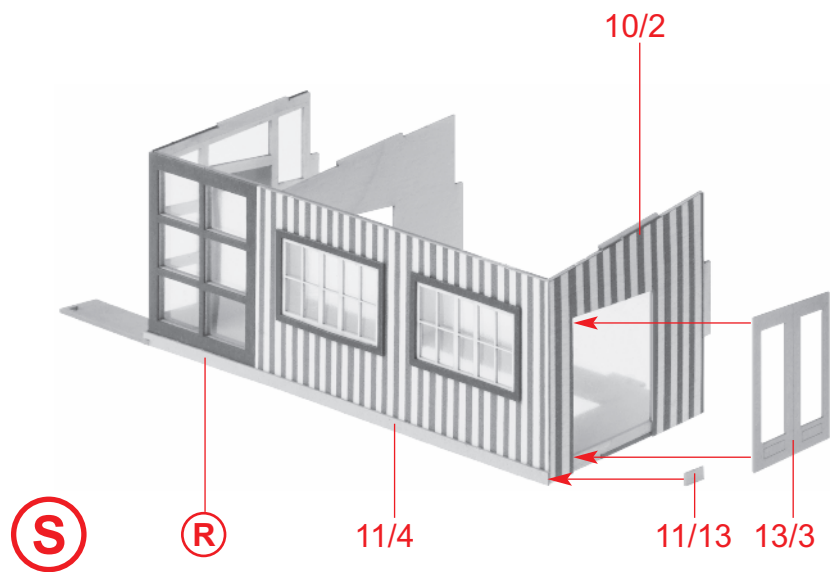

8

9/1

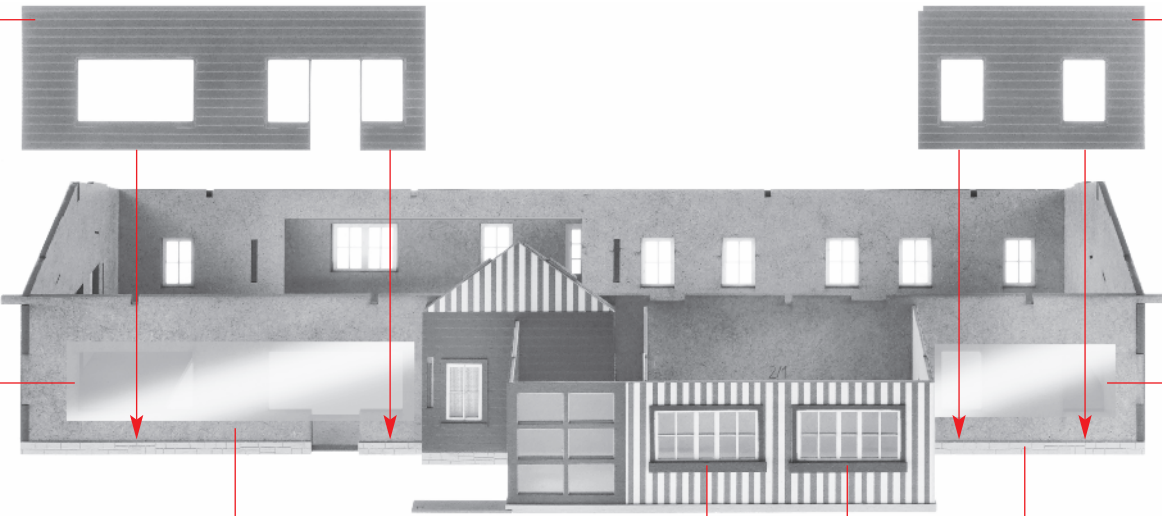

9/9

Fensterfolie
Window foil
Feuillet transparent
Vensterfolie

Fensterfolie
Window foil
Feuillet transparent
Vensterfolie

V

U

4/8

4/8

11/9

9/15

9/3

9/3

9/3

9/3

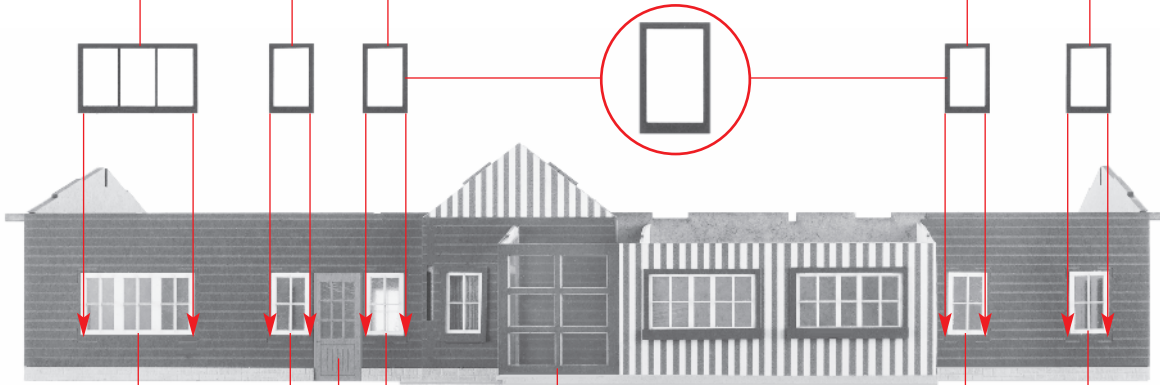

W

12/4

12/1

12/1

13/4

V

12/1

12/1

4/2

4/2

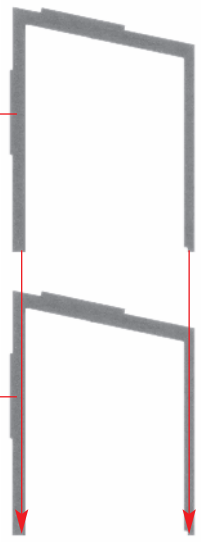

4/1

4/1

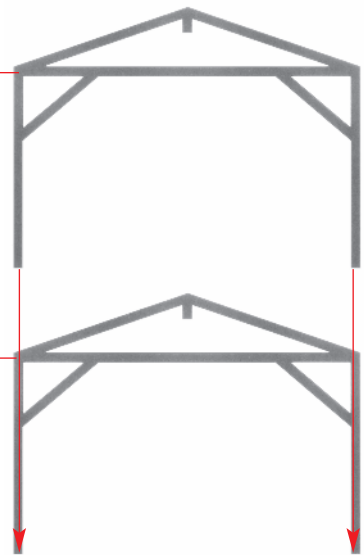

Papiermaske
Papermask
Masque
Masker **M3**

Papiermaske
Papermask
Masque
Masker **M2**

6/2

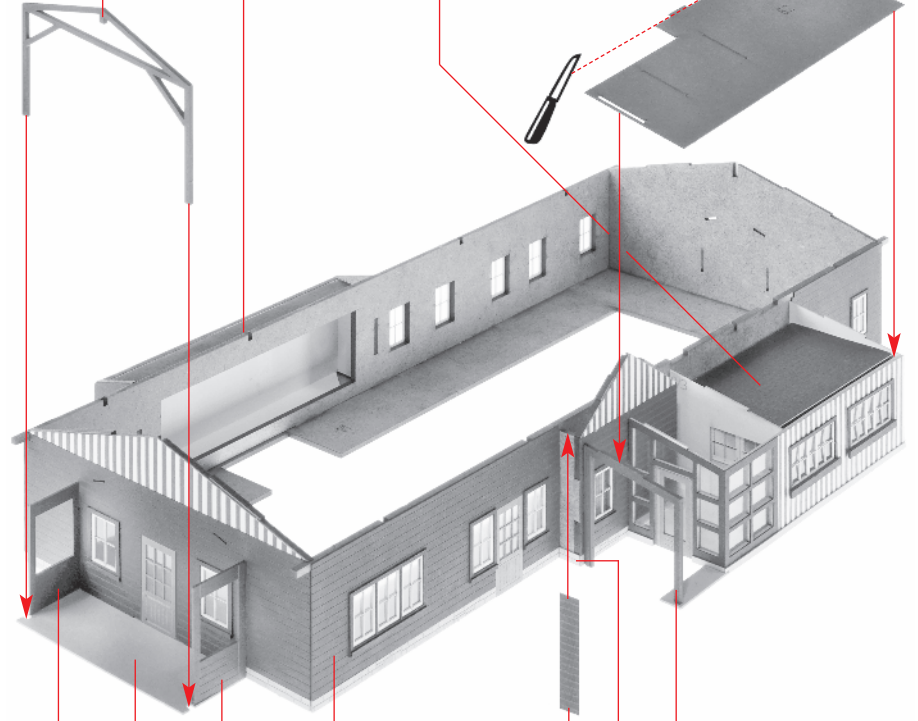

4/4

4/3

7/2



11/7

9/11



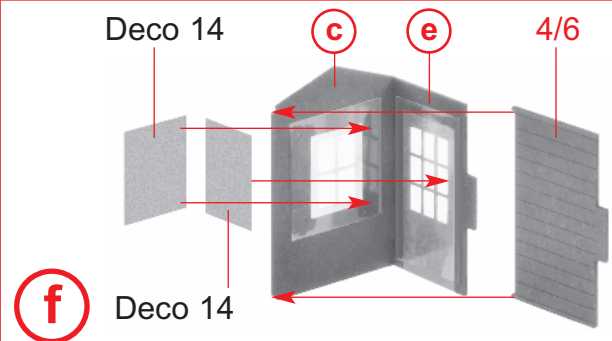
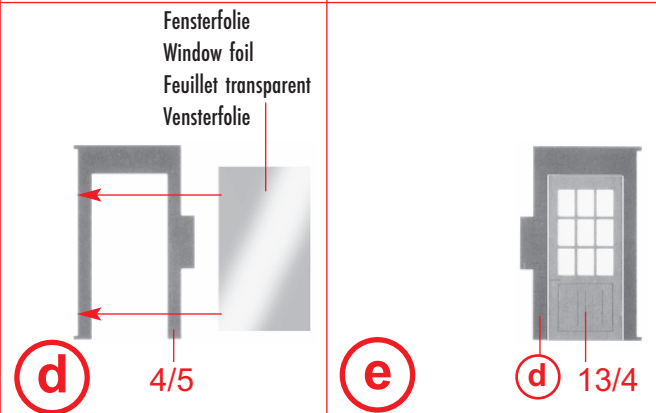
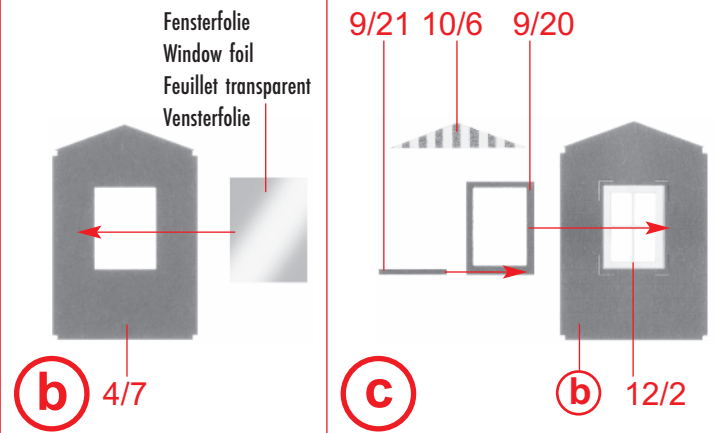
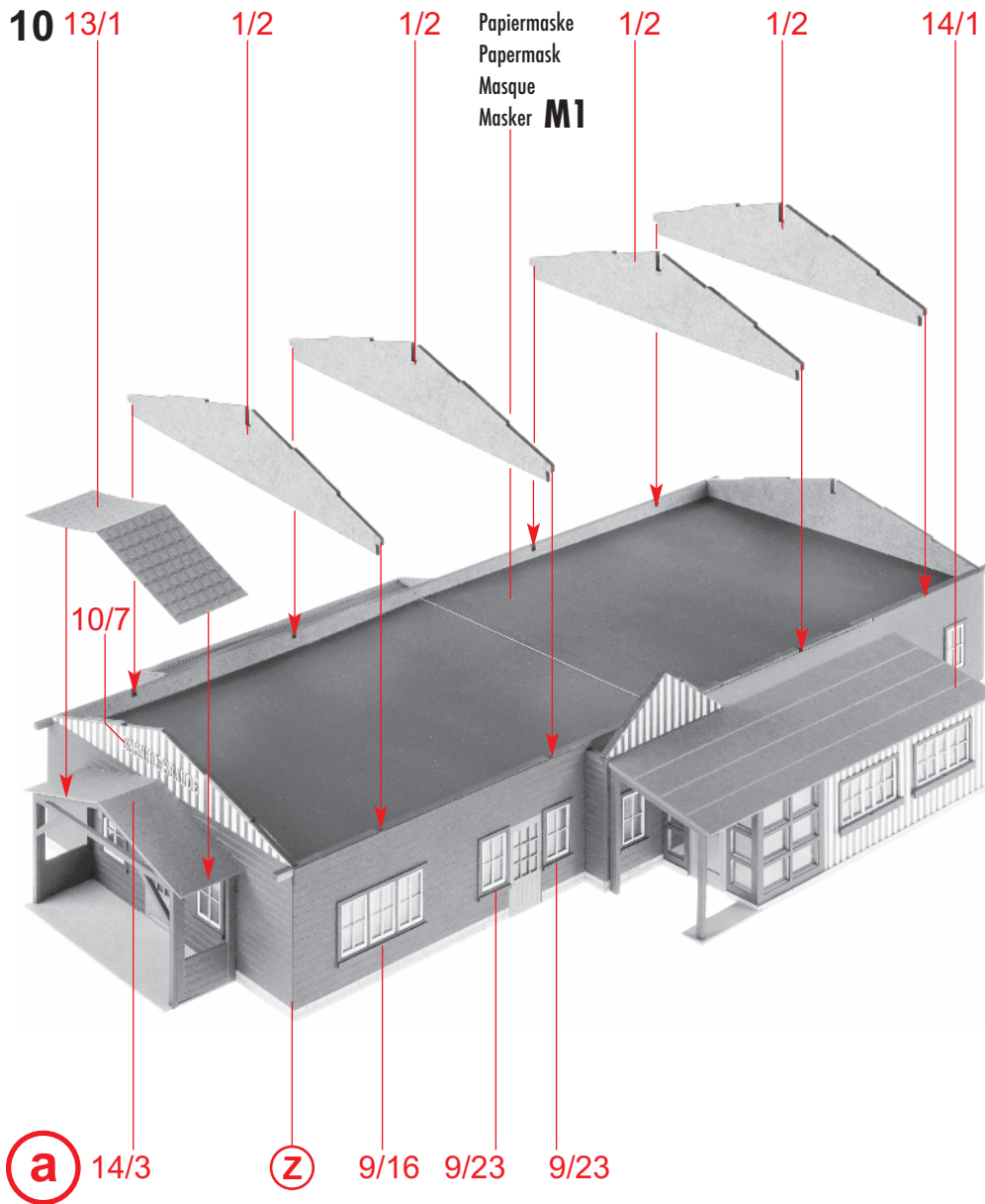

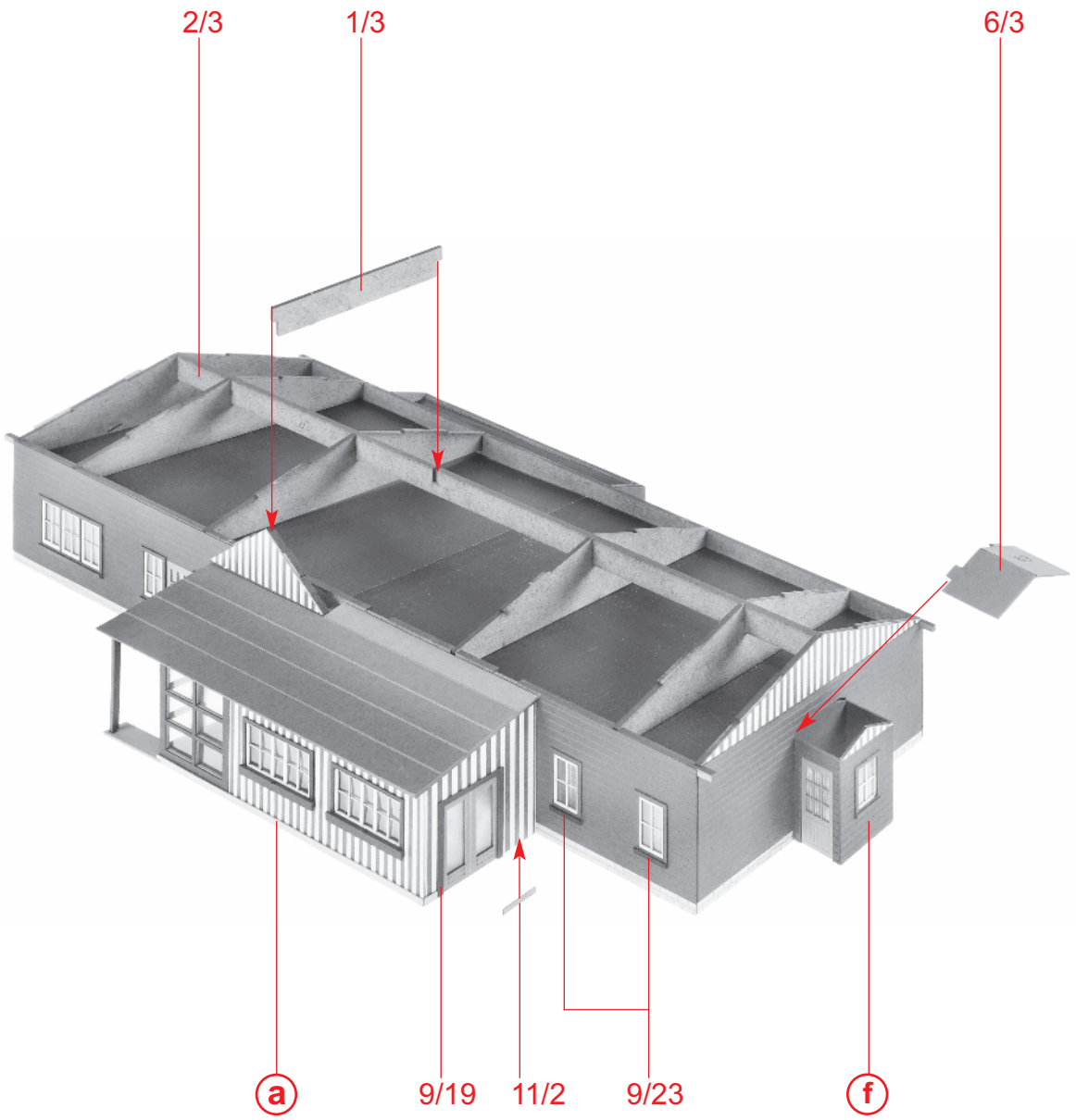

g

a

9/19

11/2

9/23

f

12

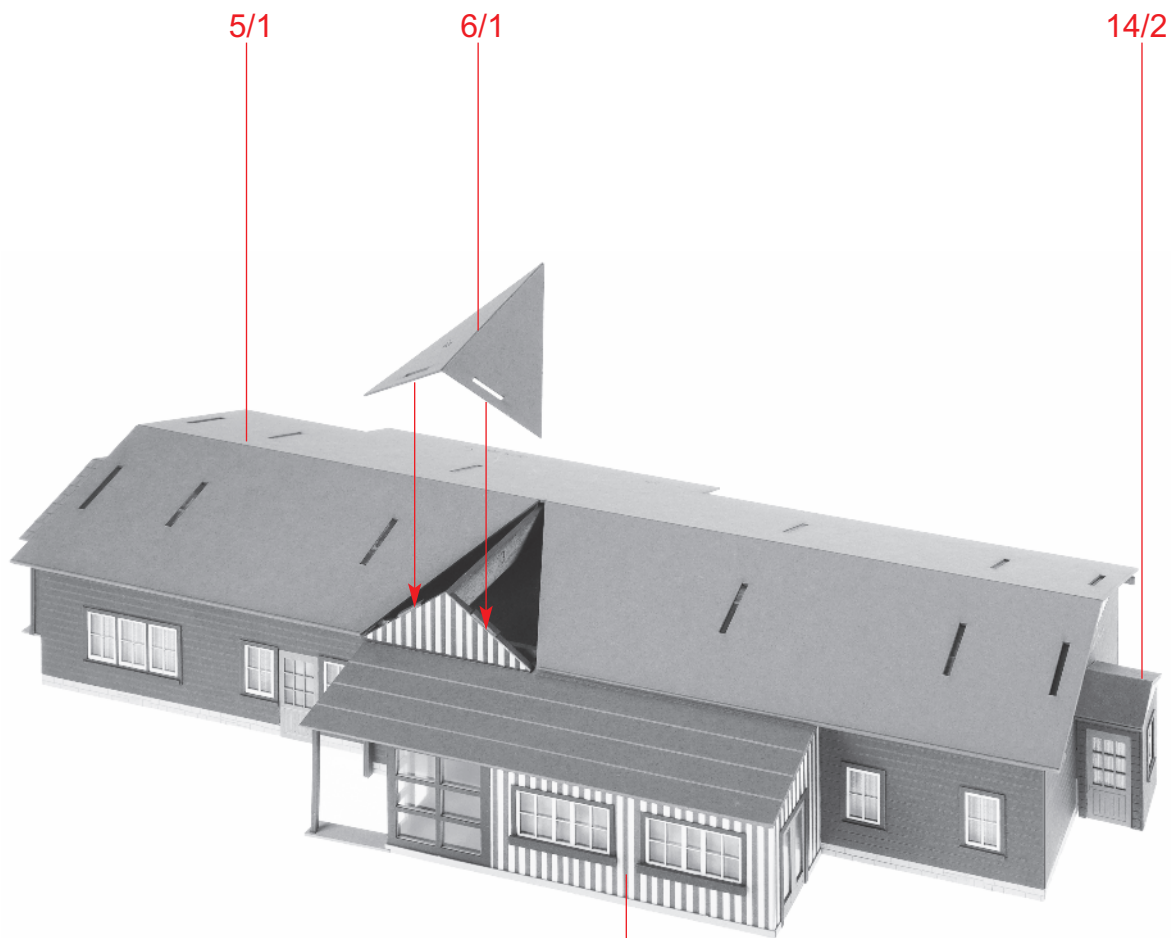

5/1

6/1

14/2

h

g

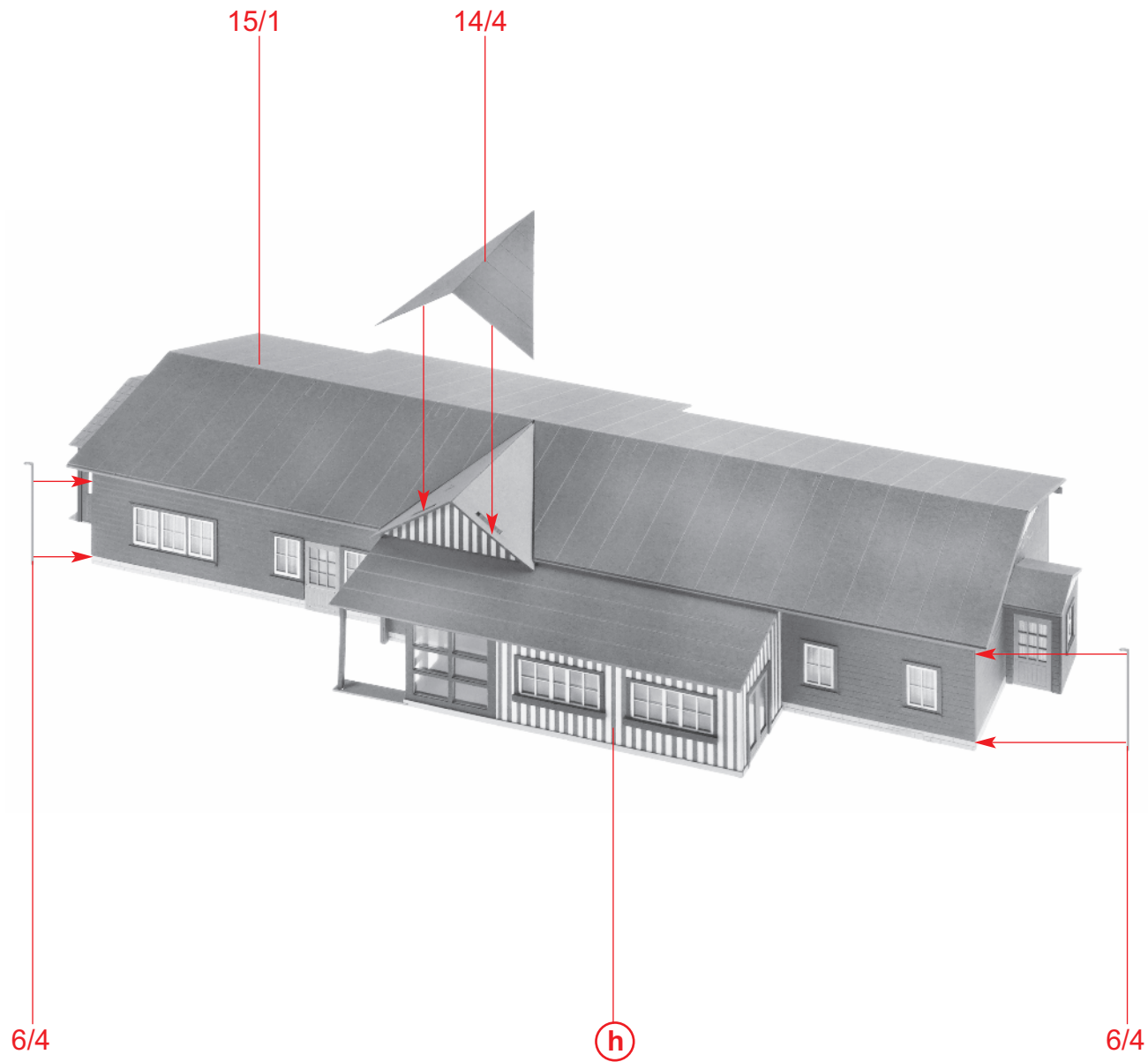

14

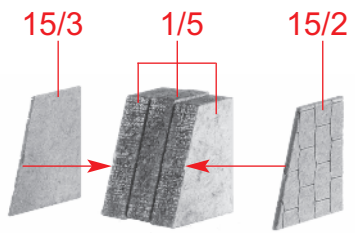

j

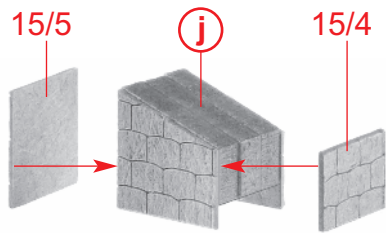

k



l

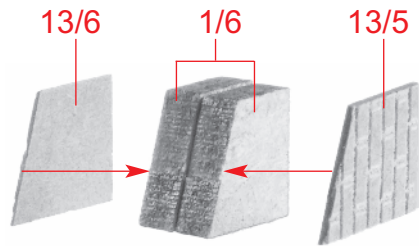

m

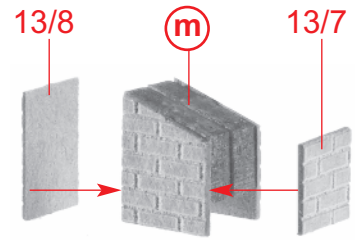

n

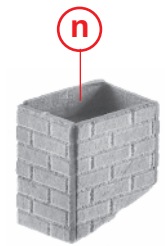

o

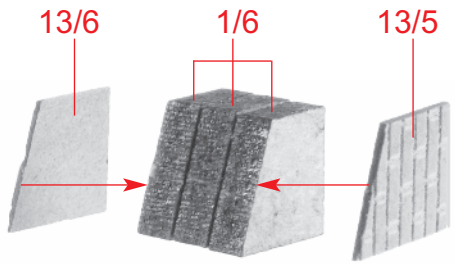

p

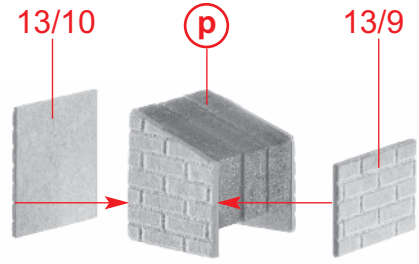

q

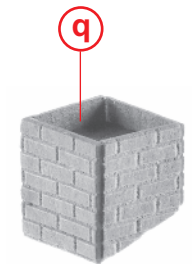

r

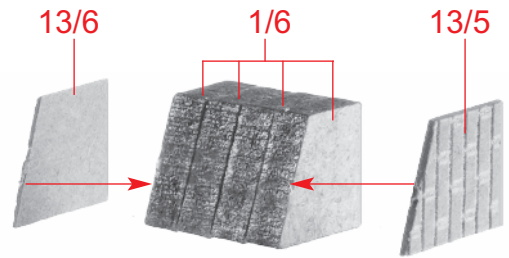

s

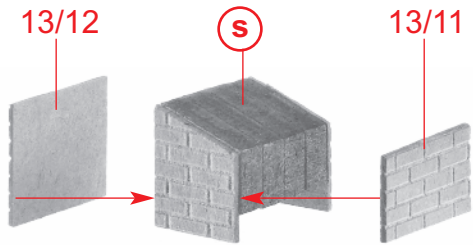

t

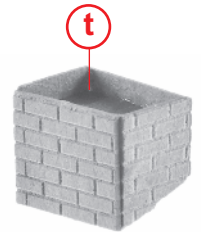

u

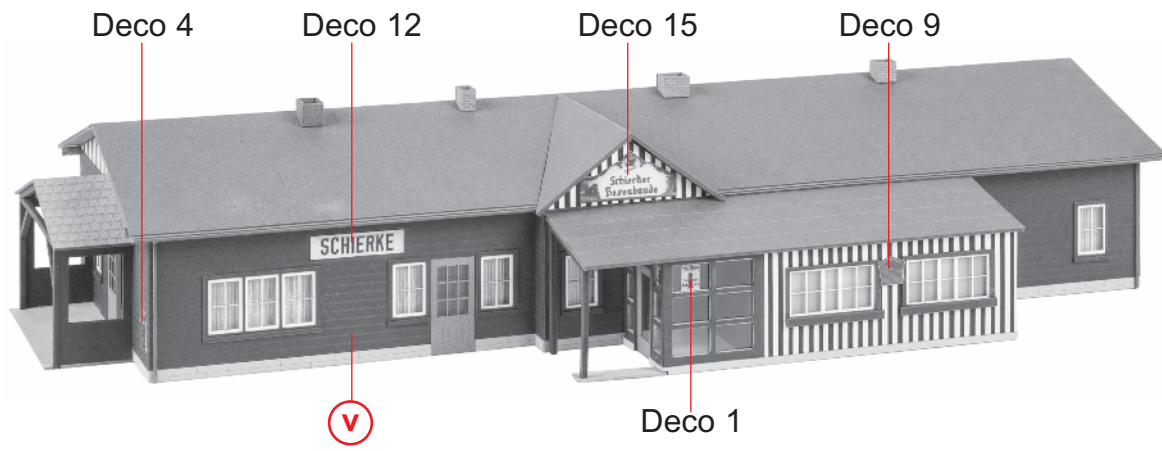
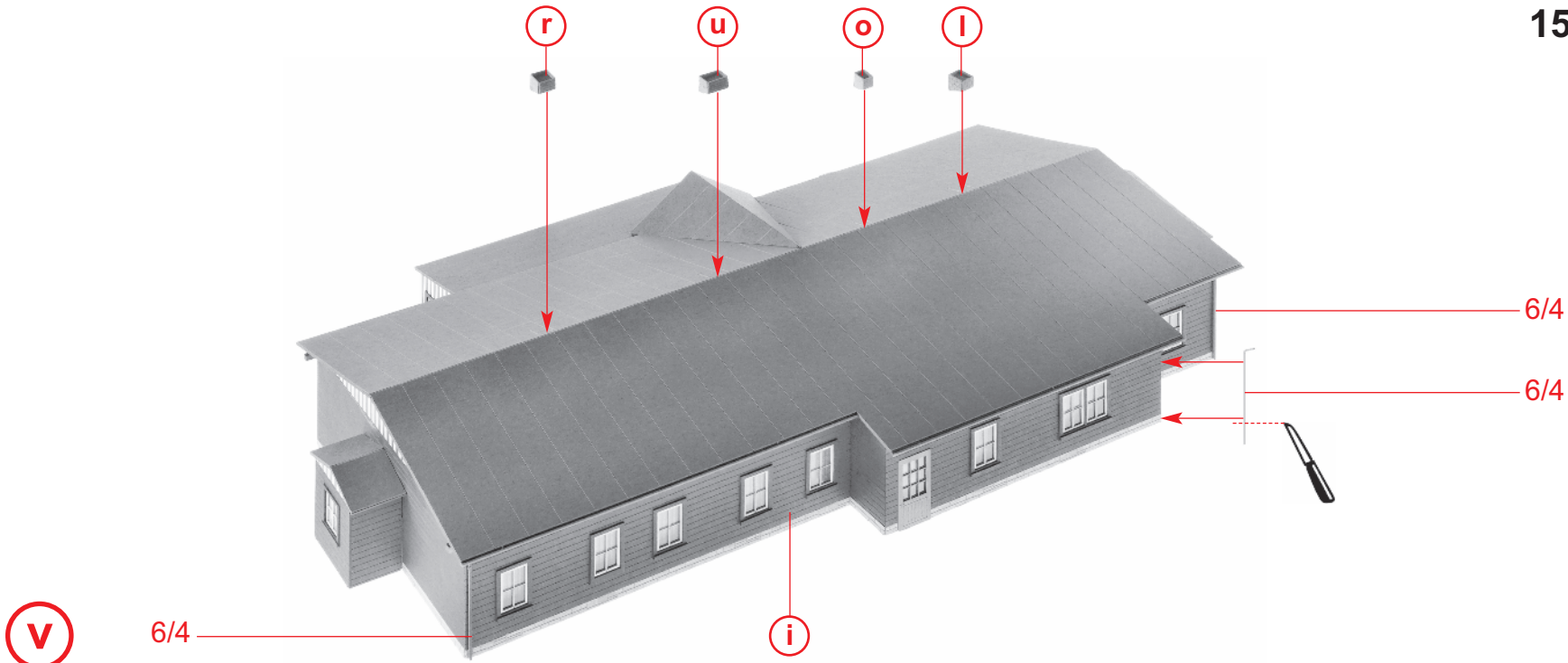

16

Deco 7

Deco 6

Deco 16

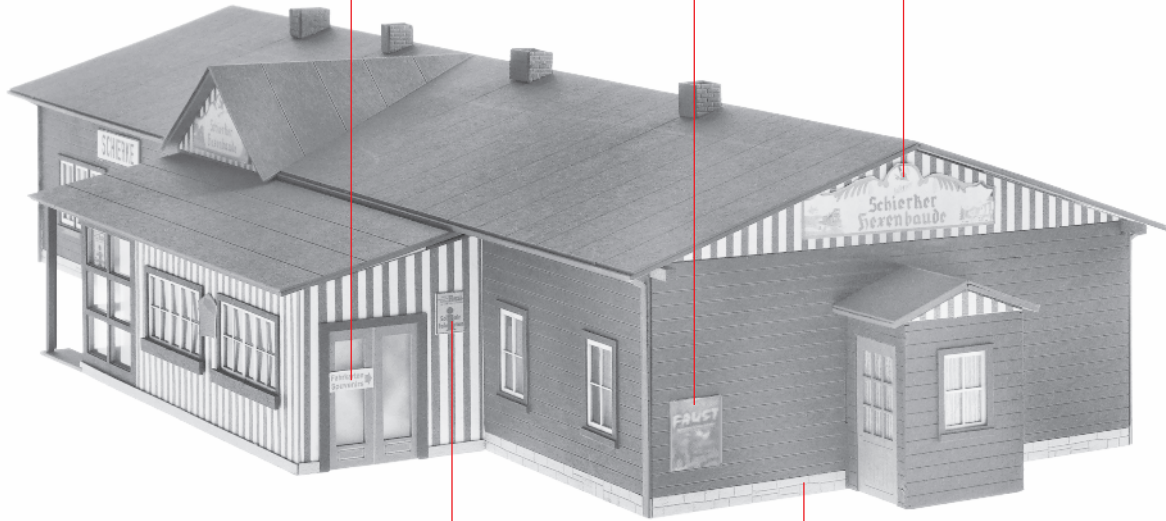

Deco 1

