

ECoSBoost Digital Amplifier

Instruction manual

Second Edition, July 2013



Content

1. EG Declaration of Conformity	3
2. WEEE-Declaration	3
3. Important Remarks-Please read this chapter first ...3	
Warning.....	4
4. Introduction – Why Booster?	4
5. Unpacking and starting up	4
5.1. Content of package	4
5.2. Locating the device	4
5.2.1. Screw the device tight	4
6. Features of the ECoSBoost	5
6.1. Power Amplifier	5
6.1.1. Fan control.....	5
6.2. Data formats.....	5
6.2.1. What does M4 mean?.....	5
6.3. mfx® feedback	5
6.4. DCC RailCom® feedback	5
6.5. ECoSlink	5
7. Appropriate digital command stations	5
7.1. ESU ECoS.....	5
7.2. Märklin® central station®.....	5
8. Power supply	6
8.1. Power supply	6
8.2. Power supply unit	6
8.2.1. 5A Power supply	6
8.2.1.1. Setting the input voltage and output voltage...6	
8.2.1.2. Practical voltage settings	6
8.2.2. 9A Power supply	7
8.2.3. Connections.....	7
8.3. Track connection	7
ECoSBoost 4A 50010.....	7
ECoSBoost 8A 50011	7
8.3.1. Wiring two-conductor tracks.....	8
8.3.2. Wiring three-conductor tracks.....	8
8.4. ECoSlink connection	8
8.5. Status-LED	9
9. Dividing the layout	9
9.1. Power section	9
9.2. Separate circuit for magnetic accessories.....	9
9.3. Transition from digital into analog sections.....	9
10. How to configure the ECoSBoost	10
10.1. Change the name of the booster.....	10
10.2. Set maximum current.....	10
10.3. Change the short-circuit behaviour.....	10
10.4. Ping the booster.....	10
11. Software-Updates	10
12. Stop” and “Go” button	11
13. Current monitor of the ECoS/Central Station	11
14. Support and Assistance	11
15. ECoS System overview	12
16. Technical data	13
16.1. Technical data ECoSBoost 4A 50010	13
16.2. Technical data ECoSBoost 8A 50011	13
17. Warranty Certificate	15

Copyright 1998 - 2013 by ESU electronic solutions ulm GmbH & Co KG. Mistakes, changes resulting in technical advancement, availability and all other rights reserved. Electrical and mechanical characteristics, dimensions and sketches are subject to change without prior notice. ESU may not be held responsible for any damage or consequential loss or damage caused by inappropriate use of the product, abnormal operating conditions, unauthorised modifications to the product, etc. Not suitable for children under 14 years of age. Inappropriate use may result in injury due to sharp points and edges.

Märklin® is a registered trademark of Gebr. Märklin® und Cie. GmbH, Göppingen, Germany. RailCom® is a registered trademark of Lenz Elektronik GmbH, Giessen. RailComPlus® is a registered trademark of Lenz Elektronik GmbH, Giessen. All other trademarks are the property of their respective legal owners.

According to its policy ESU electronic solutions ulm GmbH & Co KG continues to develop its products. Therefore ESU reserves the right to implement changes and improvements to any of the products listed in the ESU documentation.

Duplication and preproduction of this documentation in any shape or form requires prior written consent from ESU.

Declaration of Conformity

1. EG Declaration of Conformity

We, ESU electronic solutions ulm GmbH & Co. KG, Edisonallee 29, D-89231 Neu-Ulm, Germany, declare herewith in sole responsibility compliance of the product

ECoSBoost 4A 50010

ECoSBoost 8A 50011

to which this declaration is related to, with the following standards:

EN 71 1-3 : 1988 / 6 : 1994 – EN 50088 : 1996 – EN 55014, Part 1 + Part 2 : 1993

EN 61000-3-2 : 1995 – EN 60742 : 1995 – EN 61558-2-7 : 1998

According to the guidelines as per

88 / 378 / EWG – 89 / 336 / EWG – 73 / 23 / EWG

the ECoSBoost bears the CE mark.

2. WEEE-Declaration

Disposal of old electrical and electronic devices (applicable in the European Union and other European countries with separate collection system).



This mark on the product, the packaging or the relevant documentation indicates, that this product may not be treated as ordinary household garbage. Instead this product has to be delivered to a suitable disposal point for recycling of electrical or electronic equipment. By disposing of this product in the appropriate manner you help to avoid negative impact on the environment and health that could be

caused by inappropriate disposal. Recycling of materials contributes to conserve our natural environment. For more information on recycling this product please contact your local administration, the rubbish disposal service or the shop where you have purchased this product.

Batteries do not belong into household trash!

Please do not dispose of discharged batteries in your household trash: take them to a collection point at your local town hall or dealer. Thus you assure an environmentally friendly way of disposal.

3. Important Remarks–Please read this chapter first

We congratulate you to your purchase of an ESU ECoSBoost digital amplifier.

This manual will guide you step by step through the multitude of possibilities of the ECoSBoost. However, have one request:

Please read this manual carefully prior to initial operation. Although the ECoSBoost is robustly constructed there is the risk of damage due to incorrect wiring. If in doubt, avoid any „costly“ experiments!



- ECoSBoost is only intended for the use with electrical model train layouts. Never operate ECoSBoost without paying attention and never use it for controlling devices designed for transporting persons.



- ECoSBoost is not a toy. Make sure that children use this device only when adults are present.

- Only use the power supply provided for ECoSBoost. Other transformers may lead to reduced output or in extreme cases to damage of the command station.

- Use the power supply provided with ECoSBoost for the energy supply for ECoSBoost only and not for any other household appliances.

- Never use Y-adapters in order to provide power to other devices for your model trains! An unintended connection to ground could lead to damage or destruction of your ECoSBoost or the connected command station!

- Check the power supply regularly for damage on the housing or the main cable. Damaged parts may not be used under any circumstances! Do not attempt to repair the power supply! This may be fatal!

- Assure adequate ventilation of the power supply. Do not install in furniture without sufficient air circulation since this could lead to overheating or fire!

- Assure adequate ventilation of the ECoSBoost. Do not install in furniture without sufficient air circulation since this could lead to overheating or fire!

- ECoSBoost may only be operated with the devices described in this manual. Even if other devices (also from other suppliers) may have the same plugs and sockets does this not automatically indicate that such devices may be operated with ECoSBoost. Any other use as described here is not permitted.

- Adhere to the wiring diagrams shown in this manual when connecting your layout. Other circuitry could lead to damage of ECoSBoost or your command station.

- Do not drop your ECoSBoost command station or subject it to mechanical impact or vibrations. Such rough treatment could cause breakage of components within the device.

- Never expose your ECoSBoost to rain, humidity or direct sunlight. In case of high temperature variations (e.g. when you take your ECoSBoost from the cold car to your comfortably heated house) please wait for a few hours until the device has adjusted to the temperature before switching it on.

Introduction & Starting up

- When using ECoSBoost outside you must protect it from the elements under all circumstances! Only keep ECoSBoost outside as long as you run trains and avoid temperatures below 8° Celsius or above 30° Celsius.
- Do not use any aggressive chemicals, cleaning solutions or solvents for cleaning ECoSBoost. Never use liquids or spray for cleaning the monitor. Instead use a clean slightly (!) moist cloth and only when ECoSBoost is switched off.
- Do not attempt to open ECoSBoost.



Warning

Your model railway layout must never be left unattended! An unnoticed short circuit may lead to fire risk due to heating!

4. Introduction – Why Booster?

As with analogue, a sufficient power supply for the layout is essential for the safe operation of your ECoS command station or your Märklin® central station®. All power consuming devices on the layout such as locomotives, wagon lighting sets, turnouts, signals etc. have to be powered with energy.

This task is performed by the so-called “boosters”.

Boosters amplify the track signals produced by the digital command station and power the connected track section.

Both the ESU ECoS as well as the Märklin® central station ® have installed such a booster.

If the power consumption of all running trains is however, higher than the maximum current the command station is able to supply, you must divide your layout in to sections. Every section will be powered by its own booster. The ECoSBoost is exactly meant to be for this task. It is perfectly prepared for being used with the ESU ECoS or the Märklin® central station®.



The question, whether additional boosters are needed, cannot be answered easily in practice as it is difficult to determine the actual power requirement of your layout.

You can roughly estimate the power requirement as follows:

Running locos without LokSound:

Gauge N:	Between 350mA and 600mA
Gauge H0:	Between 450mA and 1000mA
Big gauges:	Between 750mA and 2000mA

Running locos with LokSound:

Gauge N or H0:	Between 450mA and 1100mA
Big gauges:	Between 1500mA and 3500mA
<u>Interior lighting:</u>	ca. 50mA per bulb or LED
<u>Turnout motor:</u>	Between 500mA and 1500mA

5. Unpacking and starting up

The ECoSBoost is safely protected in a carton with a two-part blister when delivered. Please keep the packaging and this manual in a safe place for later use. Only the original packaging guarantees protection from transport damage.

5.1. Content of package

Please check that all items are contained in the package immediately after opening it.

- ECoSBoost digital amplifier
- For 50010: power supply 90VA
- For 50011: power supply 180VA
- Separate power supply cable for Euro sockets
- Separate power supply cable for US sockets
- One piece of 2-pole track connector terminal
- Instruction manual (this booklet)

If one of the components mentioned here should be missing, please contact your retailer or dealer immediately.

5.2. Locating the device

Place the ECoSBoost on a flat, clean and dry surface within sight of your model train layout.. Provide suitable conditions for your ECoSBoost: ideally operate the ECoSBoost at room temperature. Avoid heat sources in the immediate surroundings.

Put up your ECoSBoost in such a way that the cooling slits at the front are not covered. Only then a sufficient air circulation will be ensured. Please consider that the fans start temperature-controlled and might produce exhaust air.

5.2.1. Screw the device tight

The ECoSBoost can be directly screwed onto the layout. You just need to remove the (only attached) transparent cover and using wood screws, secure through the ECoSBoost as shown in figure 1.

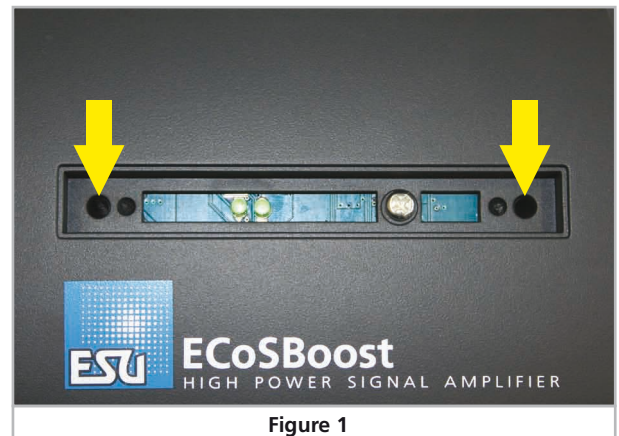

Figure 1

Features & Appropriate command stations

6. Features of the ECoSBoost

The ECoSBoost is available in two versions which, respectively, have a different maximum output.

6.1. Power Amplifier

The integrated power amplifier of the ECoSBoost corresponds exactly to the internal booster of the ECoS.

- The ECoSBoost 4A version 50010 is able to supply the track section with an output current of up to 4 Ampere. It is meant for gauges N, TT and H0.
- The ECoSBoost 8A version 50011 is able to supply the track section with an output current of up to 8 Ampere. It is meant for gauges 0, I and G.



Never operate the 8A version with H0 or even smaller-sized layouts, during a short circuit your locomotives can be irreparably damaged.

6.1.1. Fan control

Every ECoSBoost comes with one (50010) or respectively two (50011) fans, which start to cool the booster from a certain temperature. The start-up of the fan(s) cannot be influenced from the outside. As soon as the temperature has fallen to a normal level, the fan(s) will switch off.



After switch on, the fan(s) will shortly run for 3.5 seconds. This is a normal procedure and may not be considered as a malfunction.

6.2. Data formats

The ECoSBoost can basically amplify and output the following data formats:

- DCC, also with RailCom® and global Detector installed
- Märklin® Motorola®
- Selectrix®
- M4 / mfx®

Only the command station is able to create data formats and deliver them to the tracks. The ECoSBoost itself can amplify the signals, not create them.

6.2.1. What does M4 mean?

At some points in this catalog you will notice the term „M4“ for the first time rightly wonder what this might mean.

M4

This question can be answered quite simply: from 2009 forward, M4 is the name data protocol that was chosen by ESU to be implemented in their decoders. Decoders with the M4 protocol are one hundred percent compatible with command using mfx®. At such stations (e.g. Märklin® Central Station®) they will be recognized automatically and all playing functions are available just like when using mfx® other hand, our ESU command stations using M4 will recognize all (Märklin® and mfx® decoders without any restrictions and will still work without any problems. the (mutual) inventor of mfx® we can assure you of this. In short: the technique stays the same, only the name has been changed.

6.3. mfx® feedback

Every ECoSBoost has an integrated mfx® feedback module. When the ECoSBoost is connected to a mfx®-compatible command station, e.g. the Märklin® central station or ESU ECoS, all locomotives that are equipped with a mfx® decoder will be recognised. The ECoSBoost is 100% compatible with mfx®.

6.4. DCC RailCom® feedback

Each ECoSBoost is equipped with a “global detector” for the bi-directional NMRA DCC transmission (“RailCom”).

6.5. EcoSlink

Each ECoSBoost is connected to the digital command station via the EcoSlink bus. The appropriate bus cable is included in the packaging of every ECoSBoost. The EcoSlink bus enables the booster to receive track signals as well as control and status messages at the same time. Like every other device connected to the EcoSlink, the ECoSBoost will be recognised by the command station and can also be easily configured this way. Thus you are also able to assign any name to each ECoSBoost. Furthermore, the maximum output current of each ECoSBoost can be configured individually as well as the short-circuit behaviour (compare chapter 10.3.).

Since it is possible to connect up to 128 devices to the EcoSlink, your layout may grow without limitation. Each ECoSBoost represents an independent device.

If needed, the command station will transfer new firmware versions onto the ECoSBoost, therefore it is always possible to extend the functionality of the ECoSBoost in this manner.

7. Appropriate digital command stations

The ECoSBoost is appropriate for every digital command station with an ECoSlink-“busmaster”.

7.1. ESU ECoS

The ECoSBoost can be operated with every ESU ECoS command station or Central Station® „Reloaded“. ECoSBoost is able to generate the following data formats: DCC with RailCom®, Motorola®, Selectrix® and M4.



A RailCom® feedback is possible, however, the ECoS or Central Station® „Reloaded“ must have a firmware version higher than 3.6.0. You might have to update the ECoS first to this software version before you can use the ECoSBoost.

The most recent version of the ECoS software is always available at www.esu.eu via the ECoS support forum.

7.2. Märklin® central station®

The ECoSBoost can be also used with the Märklin® central station®. ECoSBoost is able to generate the mfx® and Motorola® data format. The mfx® feedback is fully guaranteed.



The Märklin® central station® must have software version 2.0.4 or higher to be able to recognise the ECoSBoost. You might have to update the central station® first to this software version before you can use the ECoSBoost.

Please contact your dealer regarding the update or refer to our website www.esu.eu for further information.

Wiring details

8. Power supply

8.1. Power supply

The ECoSBoost 4A gets its power via a 2.1mm DC-socket, the ECoSBoost 8A via a 4-pin Mini-DIN socket. Basically all DC or AC transformers with a correct output voltage can be used to power the ECoSBoost 4A, provided they generate sufficient power. With the ECoSBoost 8A you must exclusively use the supplied power supply. The secondary (supply) voltage corresponds with the track voltage; voltage stabilising or adjustment does not take place. The ECoSBoost has its own internal protective circuitry for under-voltage and overload (-current).

VIn: 14V to 19V AC or DC
Input current: Max. 5A for 4A version,
Max. 10A for 8A version



- The peak voltage of the transformer may not exceed 21V in open circuit operation. Otherwise the electronics of the ECoSBoost could be possibly destroyed.

8.2. Power supply unit



- Only use the power supply provided for ECoSBoost. Other transformers may lead to reduced output or in extreme cases to damage of the command station. We will not accept any warranty claims arising from the use of a different power supply!



- Please use the power supply provided with ECoSBoost solely for powering ECoSBoost. Do not use it for other household appliances.
- Check the power supply regularly for any visible damage of the housing or the mains cable. Damaged parts may never be used! Do not attempt to repair the power supply! Extreme danger – risk of fatal injury!
- Make sure there is sufficient ventilation around the power supply. Mounting in furniture without air circulation may lead to overheating or even fire!

Depending on the version, a power supply with the following characteristics is delivered with the ECoSBoost:

8.2.1. 5A Power supply

VIn: 100V – 240 V AC, 50 / 60 Hz
Input current: 1.8A max.
VOut: Adjustable from 15V - 21V DC, stabilised
Output current: 5A max.
Plug: DC plug, 2.1mm, 1.8m wire harness
a) Power-LED (red)
b) Output socket (low voltage)
c) Main socket

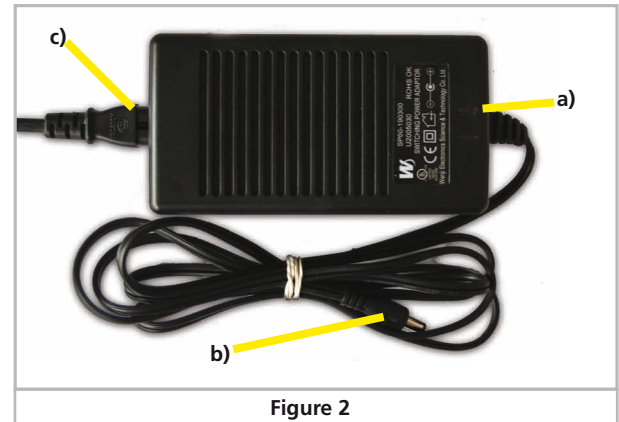

Figure 2

8.2.1.1. Setting the input voltage and output voltage

The power pack generates a stabilised voltage that serves to power your model train layout. The output voltage must be adjusted to the appropriate value subject to the scale of your trains.

For this purpose there is a small, round opening at the front of the power pack that allows you to set the voltage with the aid of a screw driver:

Left hand limit: ca. 14.5V
Right hand limit: ca. 21.5V

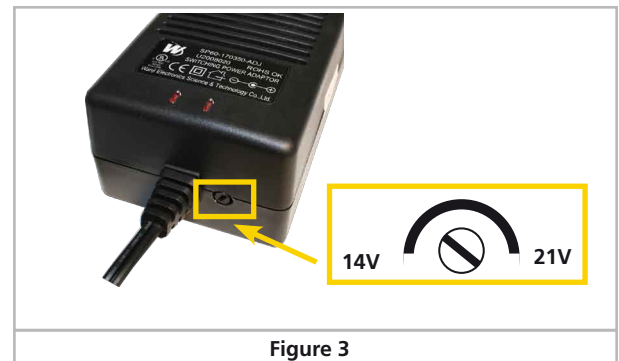

Figure 3

8.2.1.2. Practical voltage settings

We recommend the following settings for the different scales:

- N gauge: 15V - 16V
- H0 DC (DCC): 16V - 18V
- H0 three-rail-system: 18V - 20V
- 1 gauge: 18V - 21V
- G gauge: 20V - 21V

Wiring details

8.2.2. 9A Power supply

VIn: 100V – 240 V AC, 50 / 60 Hz
Input current: 3.6A max.
VOut: 19V DC, stabilisiert
Output current: 9.5A max.
Plug: 4-pin power Mini-DIN plug, 1.8m wire harness

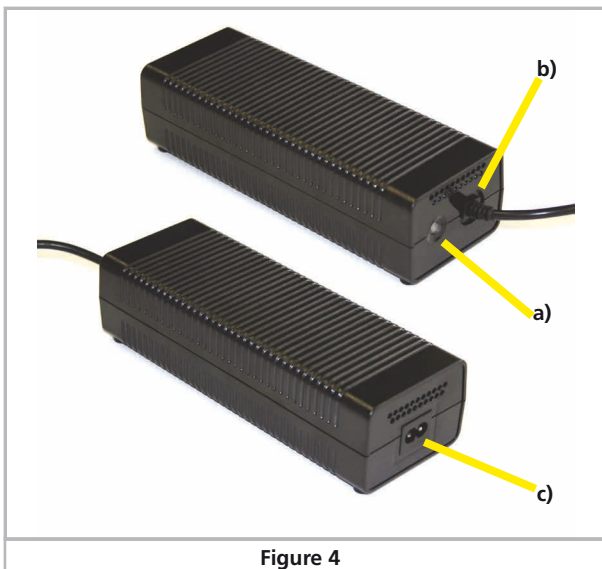

Figure 4

- a) Power-LED (red)
- b) Output socket (low voltage)
- c) Main socket

8.2.3. Connections

- First of all connect the power supply cable with the corresponding socket of the power supply. Then plug the cable in an appropriate power socket.

Figure 4 shows how the power supply can be connected to the ECoSBoostBoost.

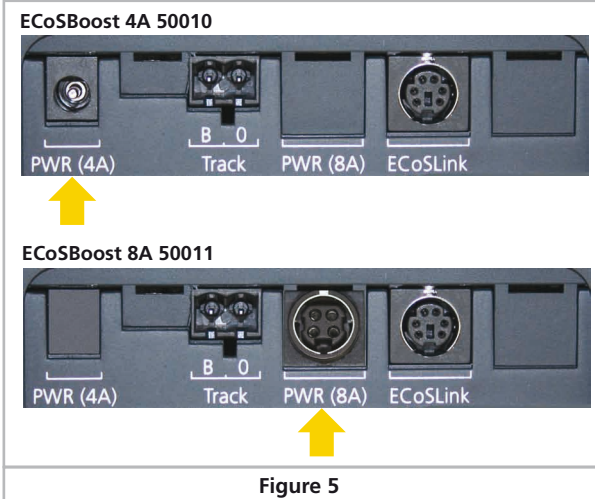

Figure 5

- To ECoSBoostBoost 4A 50010: the power supply will be connected via a 2.1mm DC socket.
- To ECoSBoostBoost 8A 50011: the power supply will be connected via a 4-pin Mini-DIN socket.



Never use Y adapters for connecting the power supply to other devices of your model railway layout besides the ECoSBoostBoost! This could cause an inadmissible contact to ground that could lead to the destruction of your ECoSBoostBoost!



The power supply generates a stabilised voltage that serves to power your model train layout. A voltage of 18V can be too high for some N gauge decoders or locos. Therefore, we recommend a lower track voltage when using the ECoSBoostBoost 4A for N gauge layouts.

8.3. Track connection

The tracks are connected via a two-way socket with a removable plug. Please make sure that you use cables of adequate size (cross-section) for your track power. We recommend wires of at least 0.75mm² (better: 1.5mm²) cross section. In larger layouts connect track power every two meters to the tracks.

ECoSBoost uses an H4-bridge (full bridge) for the track power. Therefore with ECoSBoostBoost – contrary to older Märklin® systems - there is no „Common“ (Ground).

Wiring details

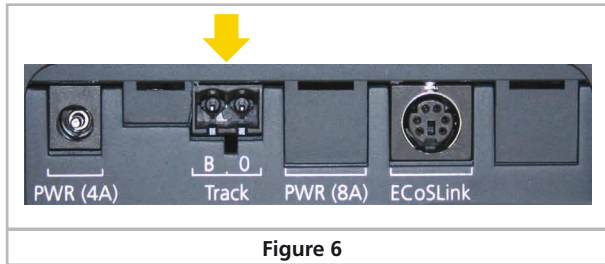

- Never connect another digital system or analogue transformer to the same circuit as the ECoSBoost. The ECoSBoost may be damaged or destroyed!



- Depending on the respective version, the ECoSBoost supplies up to 8A track current. Always consider if you actually need such a high output current. In case of a short circuit your locos may be damaged and there may be risk of fire! Also refer to chapter 10.2 regarding the current reduction.

- Please always ensure that the polarity of all track sections is identical! Terminal "B" of the first ECoSBoost and terminal „B" of the following booster must be connected to the same side of the track! Otherwise, this will lead to short-circuits whenever a locomotive crosses the district boundaries between the sections!



Remove all capacitors that may possibly have been wired to the track power supply cable in your layout. They would cause a strong heat build-up of the booster and impair the power output. Almost in every connecting track in an analogue starter kit (Roco®, Märklin®) are, respectively were, capacitors installed.

8.3.1. Wiring two-conductor tracks

Wiring takes place as shown. Polarity is not an issue (for DCC or Selectrix®).

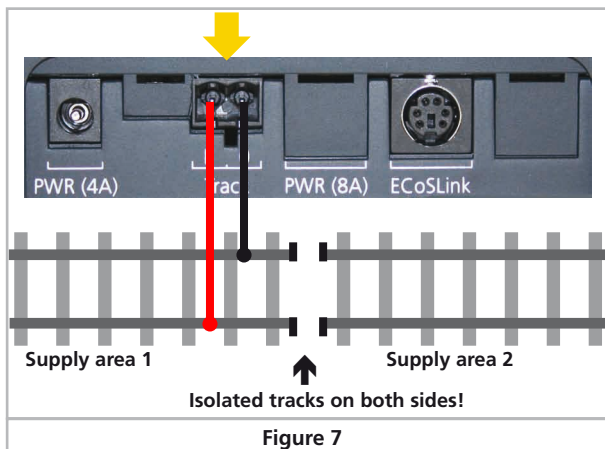

8.3.2. Wiring three-conductor tracks

Please pay attention to the right polarity, as otherwise some older decoders (e.g. k83) will not work.

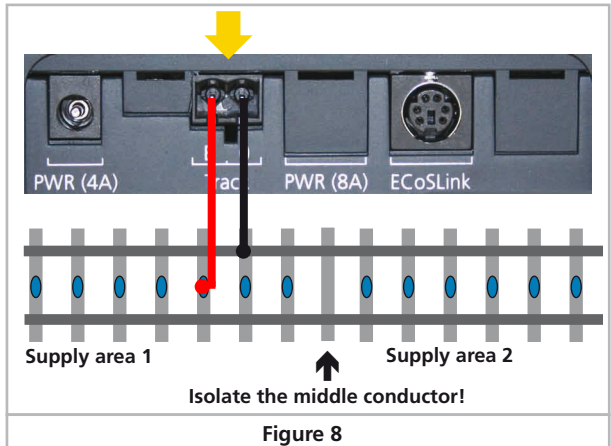

Wiring takes place as shown. If your new Motorola® locos work but the old k83 accessory decoders and older Märklin® locos do not it is most likely that polarity has been swapped.

Märklin® offers a suitable connecting track for the C-track system. Part number 74046 is not suitable! For the K track system you should use the connecting track No. 2290.

8.4. ECoSLink connection

Via the bus cable that is included in delivery, the ECoSBoost can be connected to one of the ECoSLink-Connect sockets of the command station. Please make sure that the cable is in the correct position.

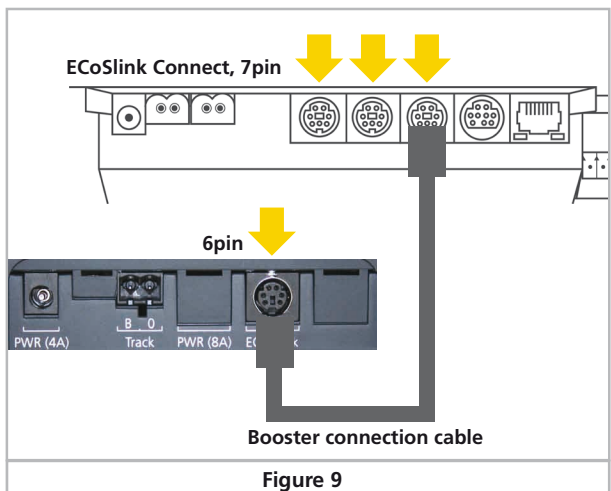

Dividing the layout



To avoid incorrect connection the amount of contact pins varies on both sides. Please only use the supplied cable that comes with the delivery. Make sure the position of the pins is correct when you plug the cable in.

Don't exert too much pressure, the pins could break or bend!

If there are to connect more than three ECoSBoost devices, the ECoS link-Bus can be extended via the ECoSlink Terminal, ordering no. 50093. Alternatively, you may use a Märklin terminal (Märklin 60125).

8.5. Status-LED

The ECoSBoost has a green status LED on its top. It shows the current operating mode:

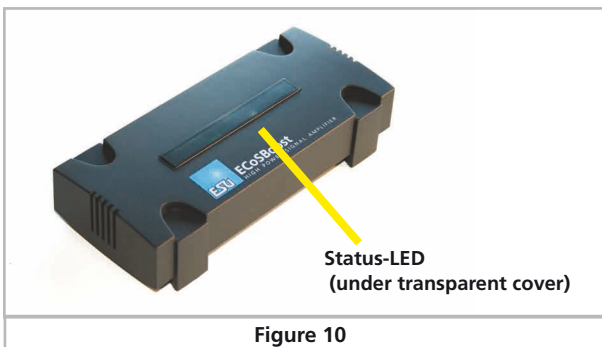

Figure 10

LED out:	No voltage supply or ECoSBoost Booster receives new firmware („update“) from command station.
LED continuously on:	Normal operating mode: connection to command station is established, track voltage is applied.
LED flashing short-long:	No connection to command station: Power supply is OK, but ECoSlink- cable is not, resp. not correctly connected.
LED flashing slowly:	Connection to command station is established, track voltage is switched off.
LED flashing quickly:	Connection to command station is established, track voltage is switched off due to overload or short-circuit.
LED flash. short-short:	Booster is pinged by command station.

9. Dividing the layout

To ensure a trouble-free operation of your layout, proper planning of the track sections is essential. We are glad to assist you here with some ideas.

9.1. Power section

Please consider the arrangement of the power sections very carefully! Assign the transitions between each of the single booster sections in a way they are rarely passed by trains.

The following divisions are useful:

- Station / Depot
- Mainline (probably divided in several sections)
- Side/branch-line (probably divided in several sections)

Regardless of the size of each single circuit, there should be a current supply from the booster to the tracks every 1.5 – 2 metres: as the transition resistance of the track sections is not negligible, the omission to feed the tracks every 1.5 – 2 metres may lead to a failing short-circuit detection due to voltage drops within the tracks.



If vehicles, which are far away from the feeding point slow down, it is – in most cases - a sign of insufficient power supply.

Each circuit needs to be separated by a single-pole isolation. This means to disrupt the contact studs of three-conductor tracks and at least one of the two-conductor tracks.

We recommend only using boosters of the same type. In a mixed operation it is likely that problems may occur whenever a locomotive crosses a district boundary due to a greatly varying time related behaviour and track voltage.

If a mixed operation is, however, unavoidable, it must be noted that a rocker contact for separating the centre rail is required at the district boundaries.

Furthermore, the track voltage of every district boundary should be as high as possible and at the same level.



Please make sure that locomotives or trains do not stop directly on a joint and bridge two district boundaries. Hereby, the outputs of both boosters will be electrically connected. Depending on the layout of the boosters and, respectively, their supply voltage equalizing currents might flow which will lead to the destruction of the booster after some time.

9.2. Separate circuit for magnetic accessories

For larger layouts we recommend to use another booster to switch all the magnet accessories separately. In this way it will be still possible to switch magnetic accessories, if the track is powered off, e.g. by a short circuit. This will increase the operating safety significantly.

9.3. Transition from digital into analog sections



With a transition from a digital section into an analogue supplied section there are certain things you must pay attention to. The track separation as explained in chapter 8.3. will not be sufficient here.



You have to isolate the digital part of your layout from the analogue on both sides at the transition points in order to avoid an electrical contact. To do so, please either use isolating track connectors or saw the track profiles.

How to configure the ECoSBoost

However, there would be a short circuit caused by the wheels anyway between the digital and the normal traction current that could destroy the ECoSBoost. To avoid this problem you need to install a separation module between the digital and the analogue section. For two-conductor tracks we recommend to use the e.g. ROCO 10768. It switches the supply of the joint section between the digital and the analogue section immediately when a short circuit occurs through crossing.

For three-conductor tracks we recommend to use track rockers as well as a both-sided track isolation (also the outer conductors!).

10. How to configure the ECoSBoost

After being connected, the ECoSBoost can be used right from the start. The command station recognises the booster automatically and integrates it into the system. This will take a few seconds. If the registration was successful, the status LED of the ECoSBoost will light steadily (compare chapter 8.5). However, it can be useful to change some of the settings.



All settings are carried out directly on the ECoSBoost / central station @. As described in chapter 20.3. of the ECoSBoost manual, all the ECoSBoost devices connected will be listed in the setup menu, submenu "ECoSlink devices".

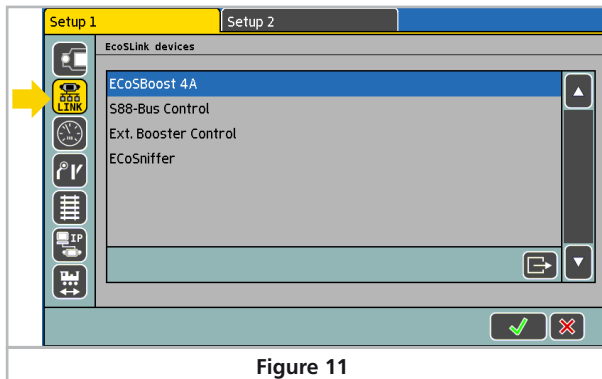

Figure 11



You are able to adjust the settings by selecting the booster desired in the setup menu "ECoSlink devices", then click onto the "Edit" button.

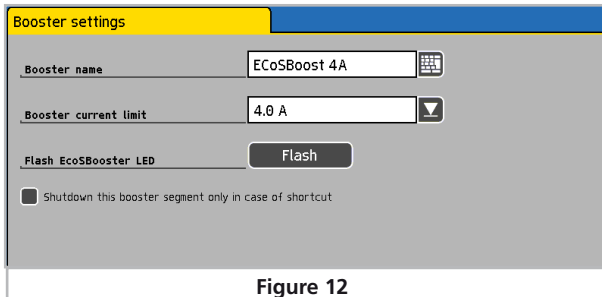

Figure 12

10.1. Change the name of the booster

The default factory name of the booster can be changed at any time, so it is easier to distinguish the boosters. The name set will remain even when used with another command station.

10.2. Set maximum current

In the choice list "Current limit of the internal booster" you can reduce the maximum current if so desired. Never set the current limited to a higher value as necessary in order to avoid damage or welded rails in case of a short circuit.

10.3. Change the short-circuit behaviour

You are able to determine the short-circuit behaviour of each booster separately.

If the respective booster causes the short circuit itself, it will switch off the tracks in every case and signalise the switch-off by its LED status. Due to security reasons you will not be able to take any influence on this behaviour.

However, if you activate the option "Ignore short circuit of other boosters", the ECoSBoost will not switch off when the short circuit took place in another booster section. By doing so, each single booster can be set to remain switched on, although there has been a short circuit within another layout section.

Especially on larger layouts it is useful to activate this option for all the boosters connected: so only the booster in whose section the short circuit took place will be switched off. This makes troubleshooting much easier.



If magnetic accessory decoders are powered by a separate ECoSBoost, as described in chapter 9.2., this booster should also ignore the short circuits of other boosters to make sure that in case of a malfunction it is still able to switch turnouts and signals.



Independent from all the settings made here, all ECoSBoost devices will always switch off if you press the "Stop" button of your ECoSBoost, resp. central station@. In this case the "Stop" button has priority.

10.4. Ping the booster

To find the booster selected among several connected boosters just click the "Flash" button. The booster will then flash short.

11. Software-Updates

The ECoSBoost software can be also updated for the ECoSlink bus, like any other device. Thus it is possible to upgrade new functions or remove weak points.

An update can only be carried out when the booster is connected to a command station. Every time you switch on the ECoSBoost, the command station will check if a latest firmware is available and will update all the boosters connected automatically. New firmware for boosters is therefore always an integrated part of the central software.



During the update the boosters cannot be accessed, the LED status shuts off. The status bar of the command station will show an update symbol.

12. Stop” and “Go” button

If you have at least one or more ECoSBoost devices connected to your command station, the behaviour of the Stop- and Go-buttons will change.

Stop

After briefly pushing the “Stop” button the command station will immediately interrupt the track current and all external boosters. The display shows “Emergency Stop”, the red “Stop” button is lit. Use the “Stop” button in case of danger or when you place or remove a loco on or from the tracks.

If the boosters are configured to switch off in case of a short circuit or an overload, the “Stop” button will also blink red.

Go

The “Go” button releases the “Emergency Stop”, resp. the short circuit. The internal and the external boosters are re-activated. Operation may continue.

If the “Go” button blinks green then at least one ECoSBoost booster in the system has been shut down due to a short circuit. However, at least one booster remains active. In this operating status all boosters can be re-activated by pressing the “Go” button.

13. Current monitor of the ECoS/Central Station

The current monitor provides valuable information regarding the energy demand of your layout. With its assistance you can determine the actual power consumption of your layout and thus better plan its power districts.

From ECoS software version 1.1.0 or central station® 2.0.4. you will find the current monitor in the set-up menu by pressing the respective symbol:

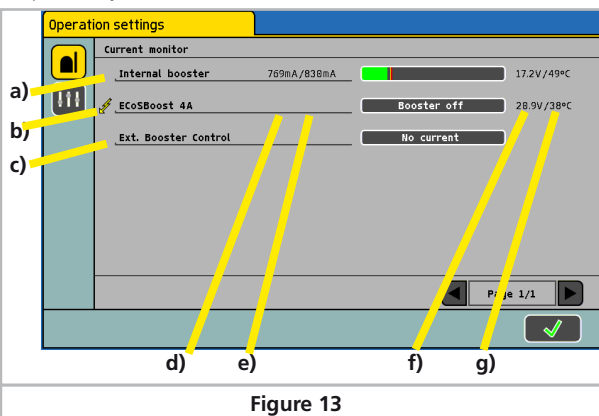

Figure 13

- a) List of all internal boosters in the system
- b) Separate display for every ECoSBoost (with triggered short circuit)
- c) Display for external DCC or 6017 boosters
- d) Present current / maximum current
- e) Bar display of weighted average (tendence)

- f) Present track voltage in the booster district
- g) Present internal temperature of the booster

The current monitor will always offer you an overview over your layout’s current supply situation. The current monitor also shows which booster has been switched off due to a short circuit.

14. Support and Assistance

Your model train dealer or hobby shop is your competent partner for all questions regarding your LokPilot decoder. In fact he is your competent partner for all questions around model trains.

There are many ways to get in touch with us. For enquiries please use either email, fax (please provide your fax-no. or email address) or go to www.esu.eu/en/forum and we will reply within a few days.

Please call our hotline only in case of complex enquiries that can’t be dealt with by email or fax. The hotline is often very busy and you may encounter delays. Rather send an email or fax and also check our website for more information. You will find many hints under “Support / FAQ” and even feedback from other users that may help you with your particular question.

Of course we will always assist you; please contact us at:

USA & Canada (English support), please contact:

Phone: +1 (570) 649-5048
Tuesday & Thursday 9:00am - 3:00pm (CT)
+1 (866) 591-6440
Fax: support@loksound.com
Email: support@loksound.com
Mail: ESU LLC
477 Knopp Drive
US-PA-17756 Muncy

Germany and all other countries, please contact:

Fax: +49 (0) 731 - 1 84 78 - 299
Email: www.esu.eu/en/forum
Mail: ESU GmbH & Co. KG
- Technical support -
Edisonallee 29
D-89231 Neu-Ulm

www.esu.eu

ECoS System overview

15. ECoS System overview

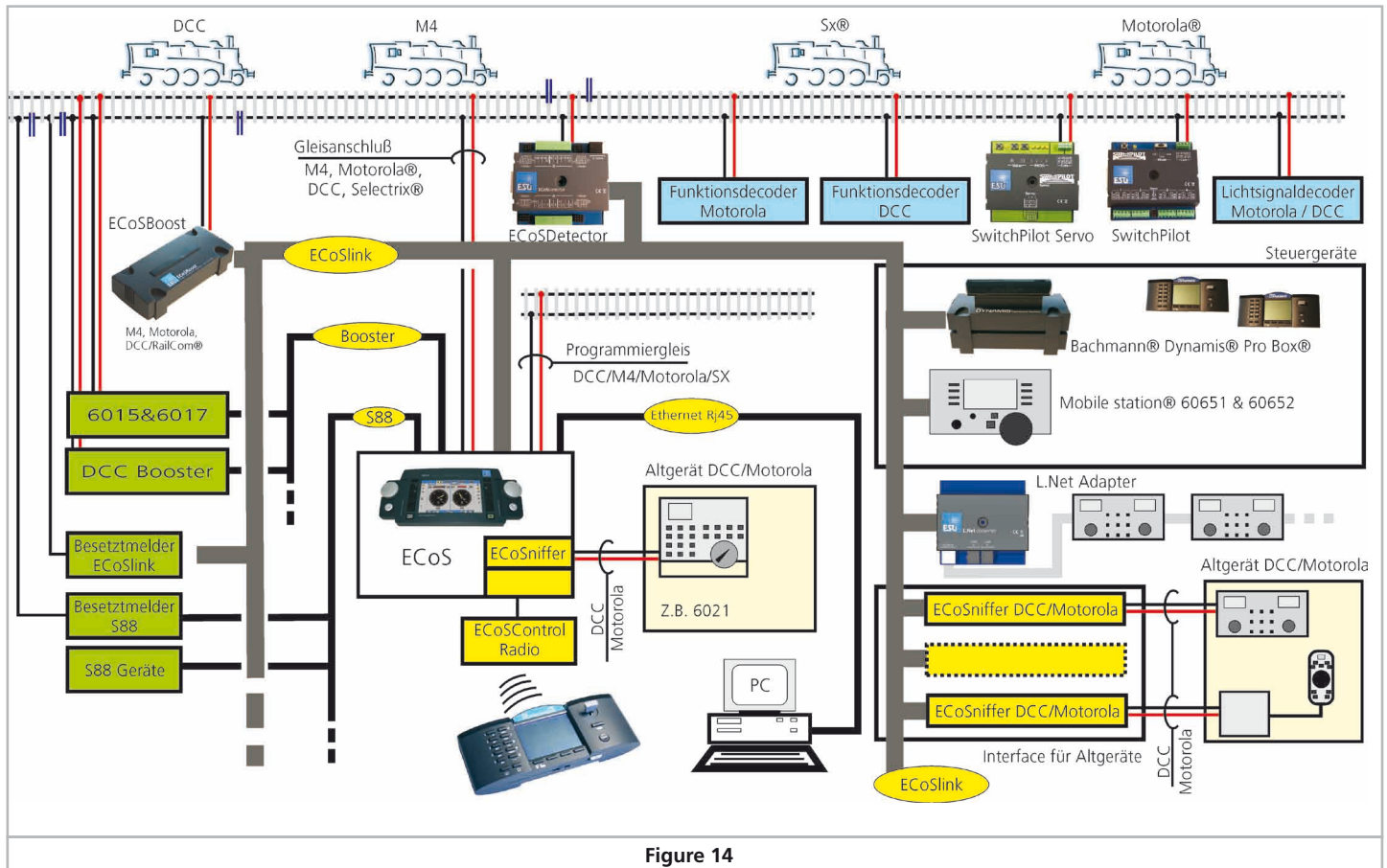

Figure 14

16. Technical data

16.1. Technical data ECoSBoost 4A 50010

Hardware

H4 booster with 4.0 A continuous output power. Output is overload and short-circuit protected. Thermally overload protection. Galvanically separation of track output and ECoSlink bus.

NMRA DCC BiDirectional feedback module "RailCom®" with integrated cutout-device.

Integrated mfx® feedback module / M4

Operational modes

Use with ESU ECoSBoost or Märklin® central station.

Supported data formats: DCC, Motorola®, Selectrix®, mfx®, M4

Dimensions

180 x 76 x 40 mm (7 x 3 x 1.5 inch)

Included in delivery

ECoSBoost with 4.0A output power, power supply 15-21V / 5A (120-240VA), connecting terminals for track connection, detailed instruction manual

16.2. Technical data ECoSBoost 8A 50011

Hardware

H4 booster with 8.0 A continuous output power. Output is overload and short-circuit protected. Thermally overload protection. Galvanically separation of track output and ECoSlink bus.

NMRA DCC BiDirectional feedback module "RailCom®" with integrated cutout-device.

Integrated mfx® feedback module / M4

Operational modes

Use with ESU ECoSBoost or Märklin® central station.

Supported data formats: DCC, Motorola®, Selectrix®, mfx®, M4

Dimensions

180 x 76 x 40 mm (7 x 3 x 1.5 inch)

Included in delivery

ECoSBoost with 8.0A output power, power supply 15-21V / 9,5A (120-240VA), connecting terminals for track connection, detailed instruction manual

Warranty card

1. Customer data

(Please write in block letters)

Name:
Street:
ZIP / City:
Country:
Email:
Phone:
Date:
Signature:..... X

4. Description of fault (use extra page, if necessary)

5. Proof of purchase

Please add the receipt to your return!

6. Your retailer / hobby store

--

Retailer's stamp or address



Warranty Certificate

17. Warranty Certificate

24 Months warranty form date of purchase

Dear customer,

Congratulations on purchasing this ESU product. This quality product was manufactured applying the most advanced production methods and processes and was subject to stringent quality checks and tests.

Therefore ESU electronic solutions ulm GmbH & Co. KG grants you a warranty for the purchase of ESU products that far exceeds the national warranty as governed by legislation in your country and beyond the warranty from your authorised ESU dealer, ESU grants an extended

Manufacturer's warranty of 24 months from date of purchase

Warranty conditions:

This warranty is valid for all ESU products that have been purchased from an authorised ESU dealer.

Any service, repair or replacement under this warranty requires proof of purchase. The filled in warranty certificate together with the receipt from your ESU dealer serves as proof of purchase. We recommend keeping the warranty certificate together with the receipt.

In case of a claim please fill in the enclosed failure report card as detailed and precise as possible and return it with your faulty product.

Please use the appropriate postage when shipping to ESU.

Extent of warranty / exclusions:

This warranty covers the repair or replacement free of charge at the discretion of ESU electronic solutions ulm GmbH & Co. KG of any faulty parts that are caused by design faults or faults in production, material or transport. Any further claims are explicitly excluded.

The warranty expires:

1. In case of wear and tear due to normal use.
2. In case of conversions of ESU – products with parts not approved by the manufacturer.
3. In case of modification of parts.
4. In case of inappropriate use (different to the intended use as specified by the manufacturer).
5. If the instructions as laid down in the user manual by ESU electronic solutions ulm GmbH & Co. KG were not adhered to.

There is no extension of the warranty period due to any repairs carried out by ESU or re-placements.

You may submit your warranty claim either with your dealer or by shipping the product in question with the warranty certificate, the receipt of purchase and the fault description directly to ESU electronic solutions ulm GmbH & Co. KG at:

Electronic solutions ulm GmbH & Co. KG
- Service department -
Edisonallee 29
D - 89231 Neu-Ulm
GERMANY



ESU P/N 04011-10679