

CG2142 Instruction Manual

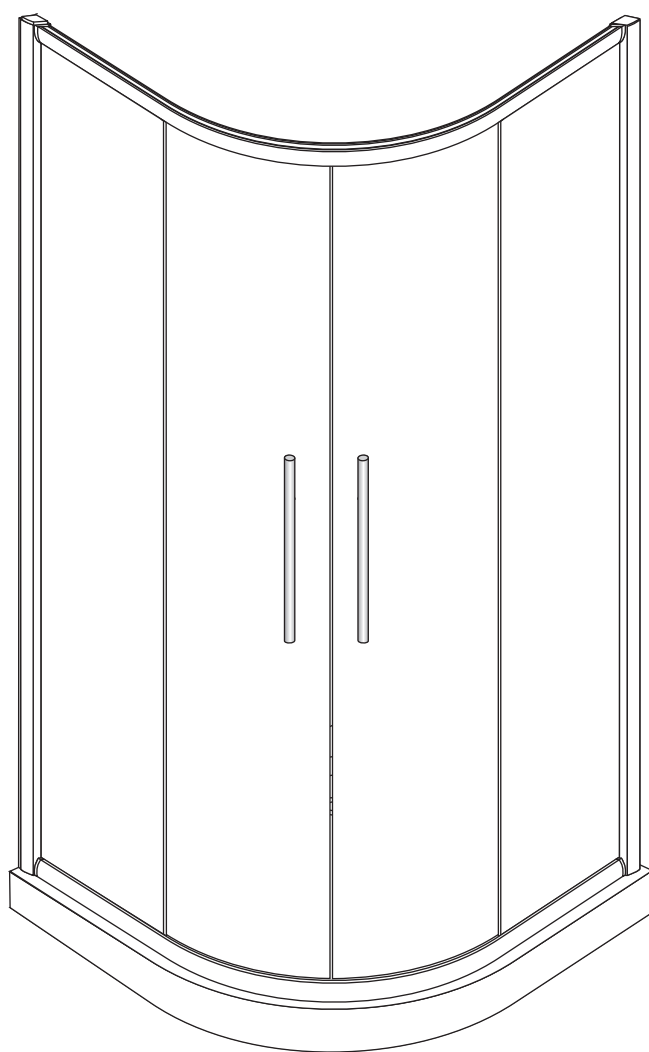

◆ General Information

Please inspect the product immediately upon receipt for transit damage, missing packs/parts or manufacturing fault. Damage reported later cannot be accepted. Please handle the product with care avoiding knocks and shock loading to all sides and edges of the glass.

Notes: Safety glass can not be re-worked.

Please read these instructions carefully before start of installation.

Special care should be taken when drilling walls to avoid hidden pipes or electrical cables.

Note: This product is heavy and may require two people to install.

Aftercare instructions

After use, your shower should be cleaned with soap and water. This is particularly important in hard water districts where insoluble lime salts may be deposited and allowed to build up.

Cleaners of a gritty or abrasive nature should not be used. Care should be taken to avoid contact with strong chemicals such as organic solvents and strippers.

Glass cleaners can be used but with caution, if in doubt contact the manufacturer of the cleaner in question.

Please keep these instructions for aftercare and customer service details.

Tools Required



This product is heavy and may require two people to install.



◆ Assembly Drawing

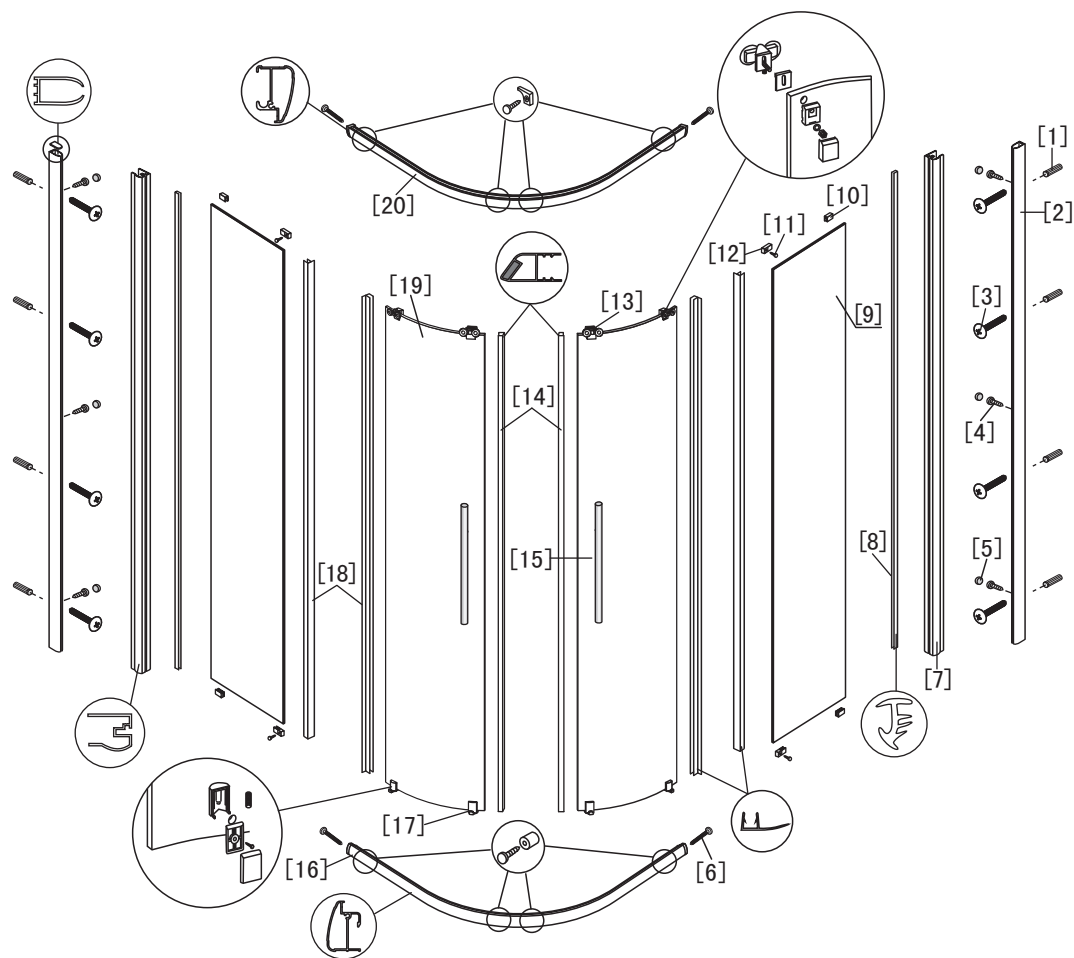

- [1] 入墙胶粒8个
- [2] 靠墙材2根
- [3] M4x35大扁头螺丝8个
- [4] M4x8自攻螺丝8个
- [5] 螺丝盖帽6个
- [6] M4x35圆头自攻螺丝4个
- [7] 铝材2根
- [8] 胶条2根
- [9] 固定扇2扇
- [10] 小“U”槽4个

- [11] M4x14自攻螺丝12个
- [12] 小压块4个
- [13] 上滑轮4套
- [14] 磁条2根
- [15] 拉手2套
- [16] 下轨道1根
- [17] 下挂钩4套
- [18] 门侧挡水胶条4根
- [19] 活动门2扇
- [20] 上轨道1根

◆ Installation Steps

Step 1

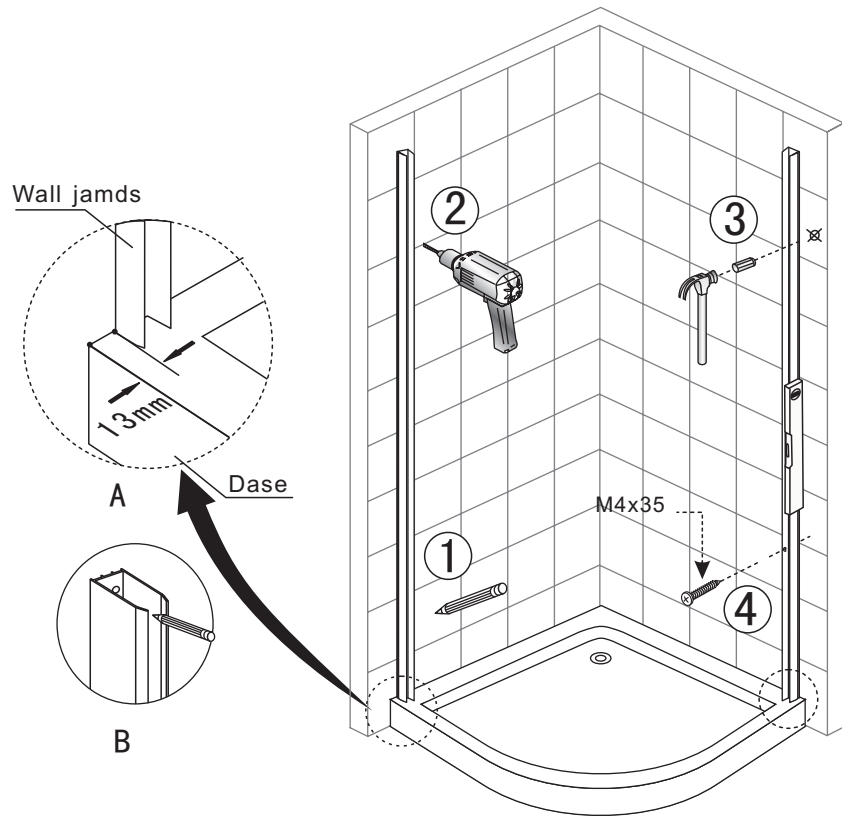

Step 2

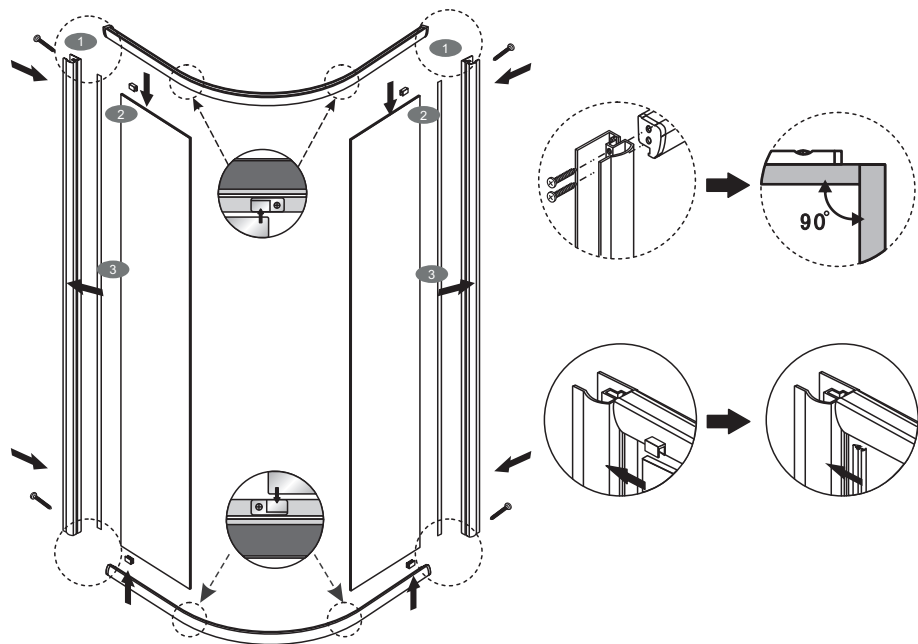

Step 3

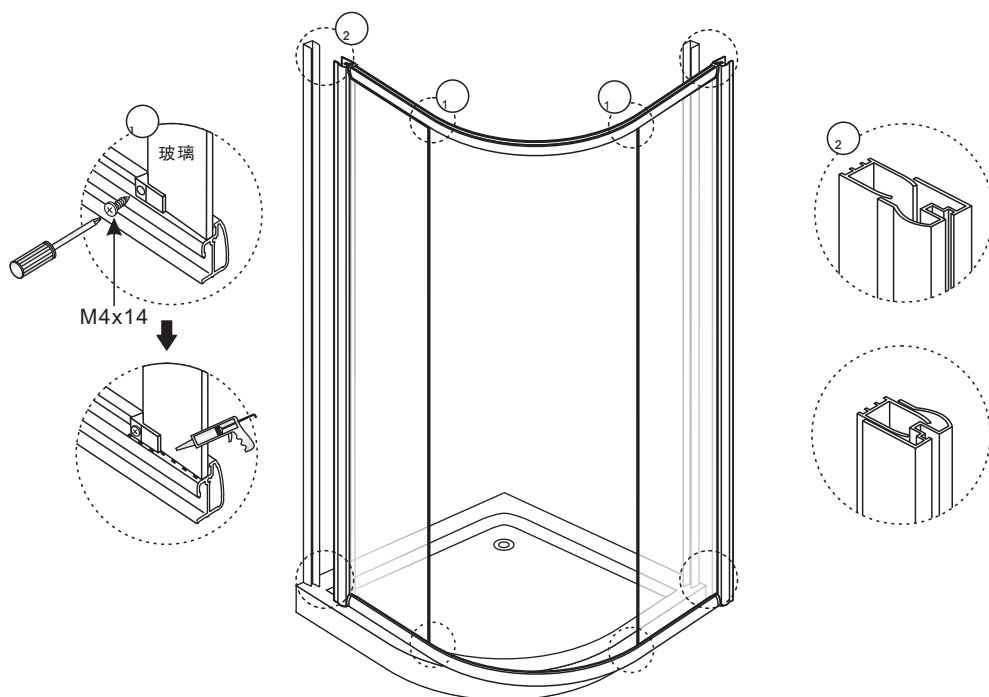

Step 4

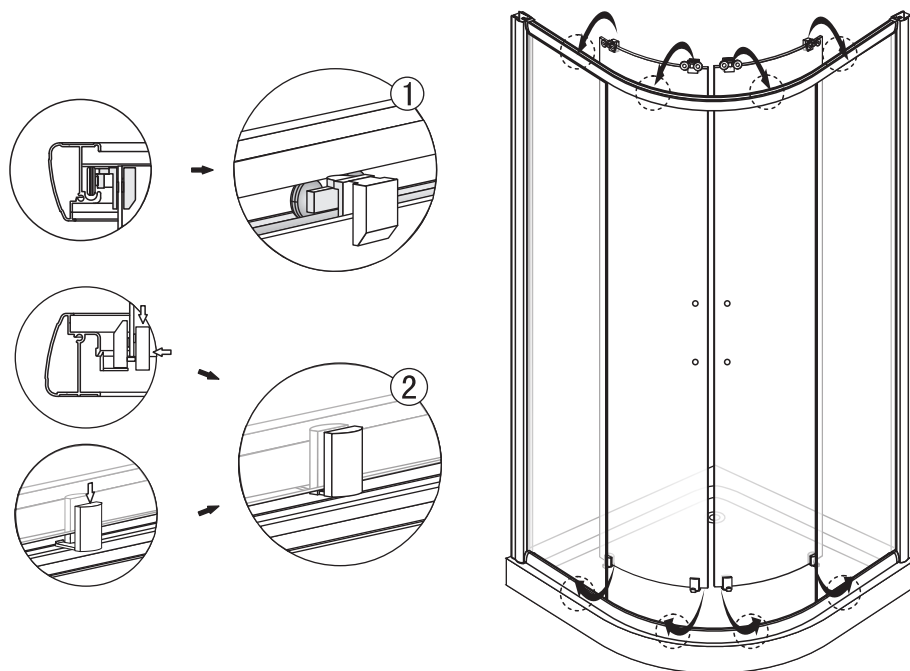

Step 5

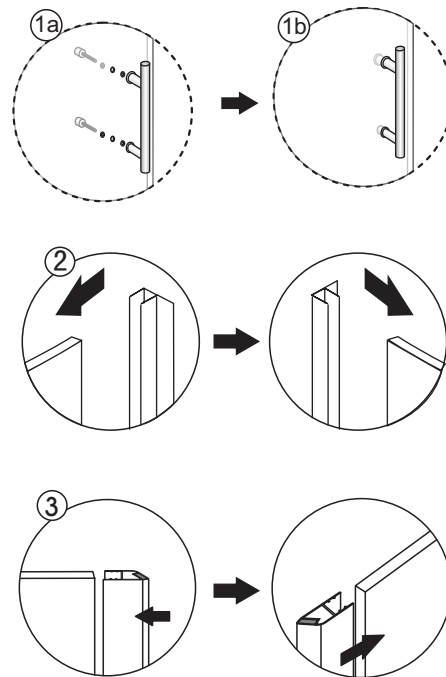
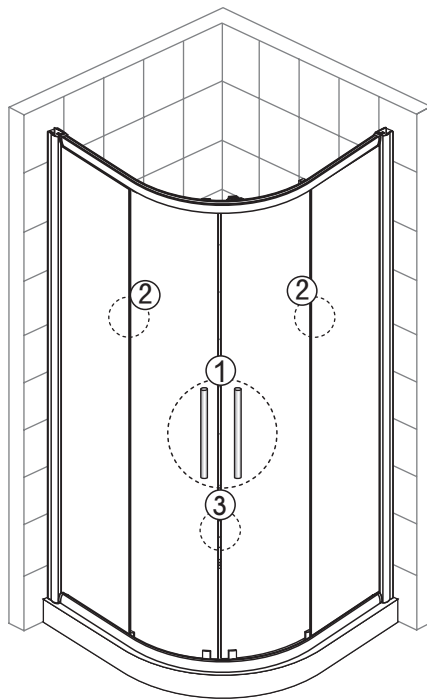

Step 6

