

# B.lux

## SPEERS S

By David Abad



### Description:

Suspension lamp system crafted in copper or brass. Features a high-luminance LED light source. It includes a glass lens that focuses the light and enhances its luminous efficiency. An optional opal diffuser provides

dispersed lighting. Available in monochrome copper or brass finishes, each with a gloss exterior and a satin interior. Versions include a white or textured matte black exterior, combined with a shade interior in satin brass or copper. Speers 1 is available in a surface version (S1) and is not dimmable. Versions with 2, 3, 4 and 6 surface suspension fixtures (S2, S3, S4, and S6) are dimmable.

SPEERS S1

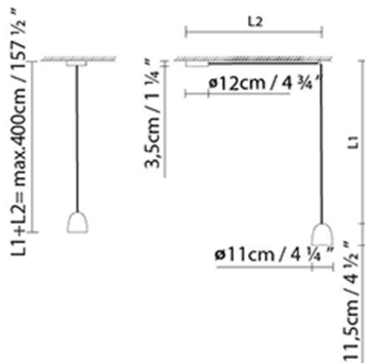

SPEERS SR1

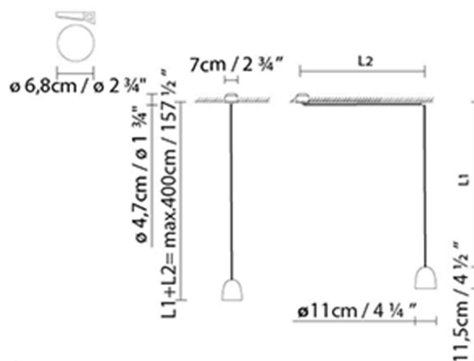

SPEERS S2

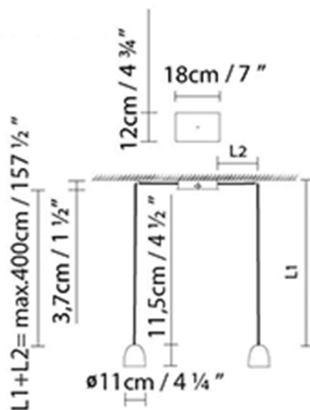

SPEERS S3

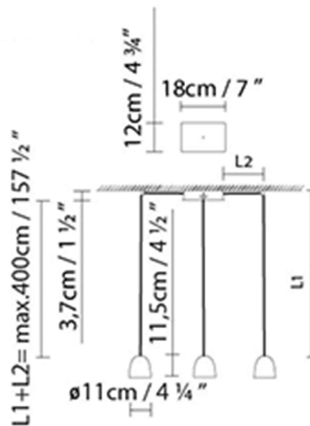



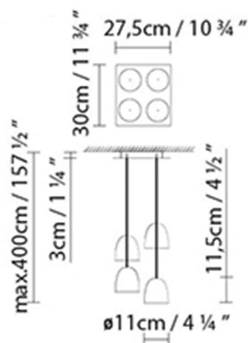



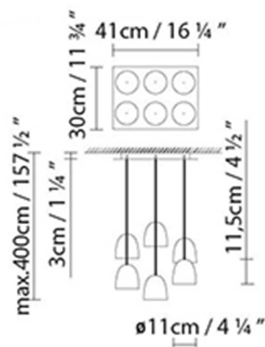

SPEERS S4



SPEERS S6



CODE	LAMP	LIGHT SOURCE	DIM	 BULB			
729300U	SPEERS S1 COPPER-COPPER						
729305U	SPEERS S1 BRASS-BRASS						
729302U	SPEERS S1 BLACK-COPPER	LED 9W 1100lm 500mA 2700K CRI≥90 110-240V	PUSH/1-10V	A++		1.75	LED 
729307U	SPEERS S1 BLACK-BRASS						
729301U	SPEERS S1 WHITE-COPPER						
729306U	SPEERS S1 WHITE-BRASS						
729390U	SPEERS SINGLE COPPER+						
729395U	SPEERS SINGLE BRASS+						
729392U	SPEERS SINGLE BLACK-COPPER+	LED 9W 1100lm 500mA 2700K CRI≥90 110-240V		A++		1,75	LED 
729397U	SPEERS SINGLE BLACK-BRASS+						
729391U	SPEERS SINGLE WHITE-COPPER+						
729396U	SPEERS SINGLE WHITE-BRASS+						
729362U	SPEERS S2/3 CANOPY BLACK+						
729361U	SPEERS S2/3 CANOPY WHITE+						
729372U	SPEERS S4 CANOPY BLACK+		PUSH/1-10V	A++			LED 
729371U	SPEERS S4 CANOPY WHITE+						
729382U	SPEERS S6 CANOPY BLACK+						
729381U	SPEERS S6 CANOPY WHITE+						



Collection:

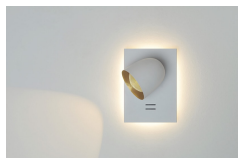

Designer

Fotometría

Technical drawing

3D

Instrucciones de montaje

**grupoblux.com**