

Choose the language

English

Italiano

Deutsch

Français

Español

ELEPHANT

Components

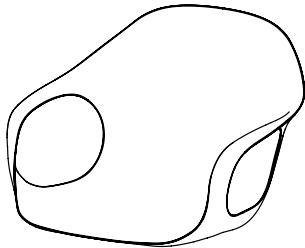
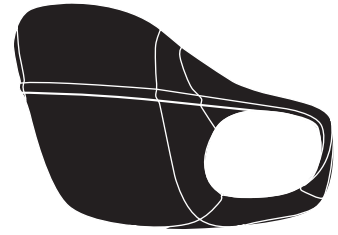

Polyurethane seat

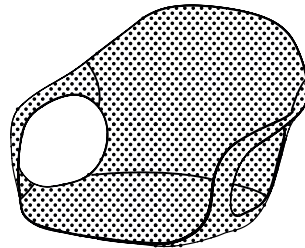

Fabric-upholstered seat

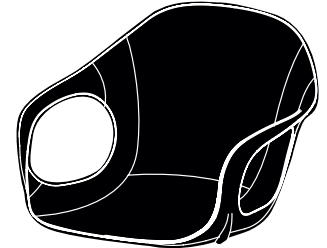

Hide-upholstered seat



Four legs

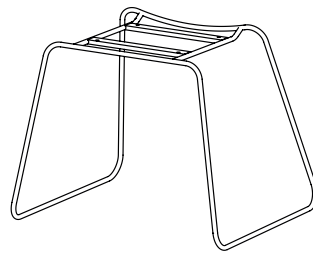

Slide frame

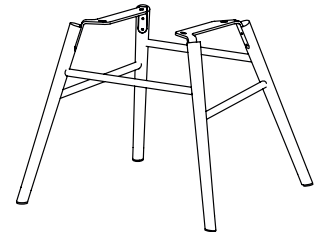

Wooden base

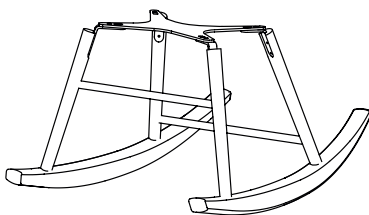

Rocking

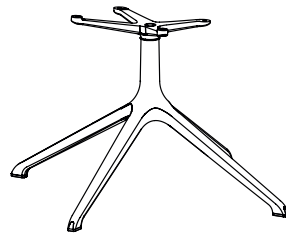

Swivel trestle

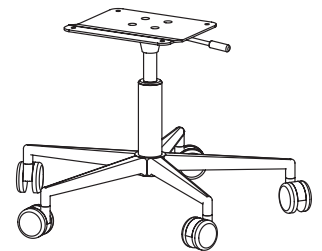

5-spoke base

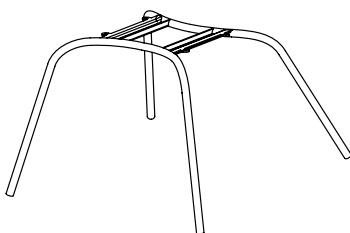

Lounge

ELEPHANT

Four legs - Polyurethane seat

Base finish:

Polished chrome steel
 Black chrome steel
 Satin chrome steel
 Brass-effect steel
 Lacquered steel (in the same colour as the polyurethane)

Body finish:

White polyurethane (P001)
 Black polyurethane (P003)
 Beige polyurethane (P004)
 Terracotta brown polyurethane (P006)
 Olive green polyurethane (P008)
 Ruby red polyurethane (P010)
 London grey polyurethane (P011)
 Dust blue polyurethane (P012)

Elephant cushion cover finish:

A = Valencia (synthetic leather), COM (Customer fabric)
 B = Field 2
 C = Clara 2, Merit
 D = Curmi, Patio, Remix 2
 E = Canvas 2, Hero, Melange Nap
 F = Regal, Scuba, Steelcut Trio 3
 G = Divina Melange 3, Hallingdal 65
 H = Twill Weave

Lips cushion cover finish:

A = COM (Customer fabric)
 B = Field 2

Note:

For COM orders see inside cover.

For info on fabric composition, see inside cover.

FEET:

Standard in hard plastic. On request we supply feet with felt insert for wooden floors.

SHIPPING INFO PRODUCTS DISASSEMBLED:

For orders of more than 8 units, chairs will be shipped knocked down (only armchairs with polyurethane seat).
 - 4 seats = 1 pack - Kg 19 / m³ 0,41.
 - 4 bases = 1 pack - Kg 14 / m³ 0,26.

Elephant cushion consumption: 0,55 ml (H. 140 cm).

Lips cushion consumption: 0,5 ml (H. 140 cm).

Reinforced packaging, see inside cover.

Code	Base	Body		
		pack	m ³	Kg
		Polyurethane		
05ELE11	Lacquered steel, Polished chrome steel, Black chrome steel	1	0,4	10
	Brass-effect steel, Satin steel			

1 armchair in each package

Optionals

Code	Description	Cover											pack	m ³	Kg			
		A	B	C	D	E	F	G	H	L1	L2	L3						
20ELE01	Elephant removable cushion (not removable cover)												-	-	-	1	0,02	1
20LIR01	LIPS-R removable cushion (not removable cover)			-	-	-	-	-	-	-	-	-	-	-	-	1	0,01	1
20LIS01	LIPS-S removable cushion (not removable cover)			-	-	-	-	-	-	-	-	-	-	-	-	1	0,01	1
02PIE03	Set of felt feet															-	-	-

ELEPHANT (20ELE01)

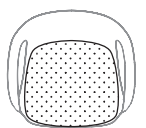

kg
0,6

LIPS-R (20LIR01)

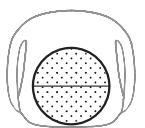

kg
0,6

LIPS-S (20LIS01)

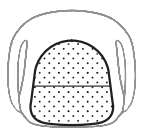

kg
0,6

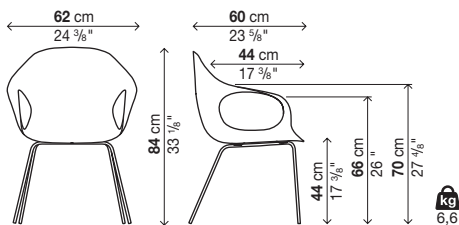

ELEPHANT

Four legs - Hide upholstered seat (not removable)

Base finish:

Polished chrome steel
 Black chrome steel
 Satin chrome steel
 Brass-effect steel
 Lacquered steel (in the same colour as the polyurethane)

Finish of cover:

"Cuoietto" (C) hide
 Natural or black full grain hide (PF)

Note:

Important: sizes and finishes marked with (!) require longer production lead time, about 6 weeks from the date of the order.

For stitching and edge colours refer to "colour chart" on inside cover.

FEET:

Standard in hard plastic. On request we supply feet with felt insert for wooden floors.

Reinforced packaging, see inside cover.

Code	Base	Body		pack	m ³	Kg
		Cuoietto (C) hide (!)	"Full-grain" hide (PF) (!)			
05ELE01	Lacquered steel, Polished chrome steel, Black chrome steel			1	0,4	11,5
	Brass-effect steel, Satin steel					

1 armchair in each package

Optionals

Code	Description	pack	m ³	Kg
02PIE03	Set of felt feet	-	-	-

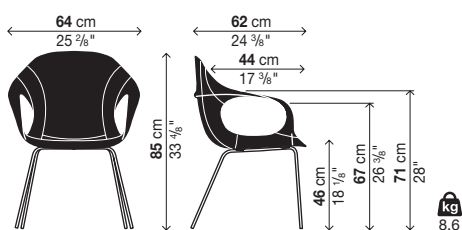

ELEPHANT

Four legs - Fabric upholstered seat (not removable)

Base finish:

Polished chrome steel
 Black chrome steel
 Satin chrome steel
 Brass-effect steel
 Lacquered steel (in the same colours as the polyurethane)

Finish of cover:

B = COM (Customer fabric)
 D = Remix 2
 E = Canvas 2, Hero, Melange Nap
 F = Regal, Steelcut Trio 3
 G = Divina Melange 3, Hallingdal 65
 H = Twill Weave

Note:

For COM orders see inside cover.

For info on fabric composition, see inside cover.

FEET:

Standard in hard plastic. On request we supply feet with felt insert for wooden floors.

COM consumption: 1,5 ml (H. 140 cm).

Reinforced packaging, see inside cover.

Code	Base	Cover											pack	m ²	Kg	
		A	B	C	D	E	F	G	H	L1	L2	L3				
05ELE51	Lacquered steel, Polished chrome steel, Black chrome steel	-		-							-	-	-	1	0,4	11
	Brass-effect steel, Satin steel	-		-							-	-	-			

1 armchair in each package

Optionals

Code	Description	pack	m ²	Kg
02PIE03	Set of felt feet	-	-	-

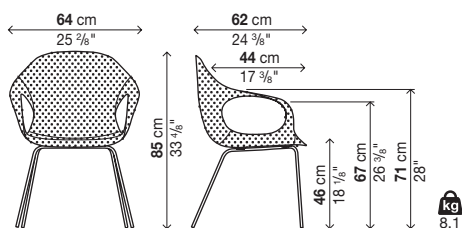

ELEPHANT

Slide frame - Polyurethane seat

Base finish:

Polished chrome steel
 Black chrome steel
 Satin chrome steel
 Brass-effect steel
 Lacquered steel (in the same colour as the polyurethane)

Body finish:

White polyurethane (P001)
 Black polyurethane (P003)
 Beige polyurethane (P004)
 Terracotta brown polyurethane (P006)
 Olive green polyurethane (P008)
 Ruby red polyurethane (P010)
 London grey polyurethane (P011)
 Dust blue polyurethane (P012)

Elephant cushion cover finish:

A = Valencia (synthetic leather), COM (Customer fabric)
 B = Field 2
 C = Clara 2, Merit
 D = Curmi, Patio, Remix 2
 E = Canvas 2, Hero, Melange Nap
 F = Regal, Scuba, Steelcut Trio 3
 G = Divina Melange 3, Hallingdal 65
 H = Twill Weave

Lips cushion cover finish:

A = COM (Customer fabric)
 B = Field 2

Note:

For COM orders see inside cover.

For info on fabric composition, see inside cover.

FEET:

Standard in hard plastic. On request we supply feet with felt insert for wooden floors.

SHIPPING INFO PRODUCTS DISASSEMBLED:

For orders of more than 8 units, chairs will be shipped knocked down (only armchairs with polyurethane seat).

- 4 seats = 1 pack - Kg 19 / m³ 0,41
 - 4 bases = 1 pack - Kg 19 / m³ 0,26

Elephant cushion consumption: 0,55 ml (H. 140 cm).

Lips cushion consumption: 0,5 ml (H. 140 cm).

Reinforced packaging, see inside cover.

Code	Base	Body	
			pack m ³ Kg
		Polyurethane	
05ELE12	Lacquered steel, Polished chrome steel, Black chrome steel		1 0,4 11,2
	Brass-effect steel, Satin steel		

1 armchair in each package

Optionals

Code	Description	Cover										pack m ³ Kg		
		A	B	C	D	E	F	G	H	L1	L2		L3	
20ELE01	Elephant removable cushion (not removable cover)										-	-	-	1 0,02 1
20LIR01	LIPS-R removable cushion (not removable cover)			-	-	-	-	-	-	-	-	-	-	1 0,01 1
20LIS01	LIPS-S removable cushion (not removable cover)			-	-	-	-	-	-	-	-	-	-	1 0,01 1
02PIE03	Set of felt feet													- - -

ELEPHANT (20ELE01)

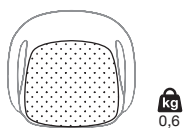

LIPS-R (20LIR01)

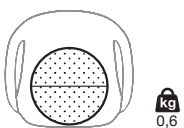

LIPS-S (20LIS01)

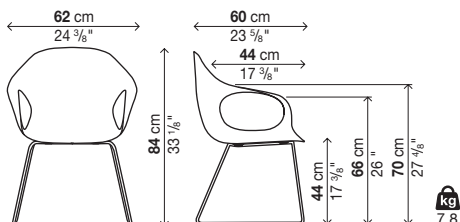
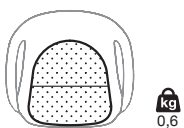

ELEPHANT

Slide frame - Hide upholstered seat (not removable)

Base finish:

- Polished chrome steel
- Black chrome steel
- Satin chrome steel
- Brass-effect steel
- Lacquered steel (in the same colour as the polyurethane)

Finish of cover:

- "Cuoietto" (C) hide
- Natural or black full grain hide (PF)

Note:

Important: sizes and finishes marked with (!) require longer production lead time, about 6 weeks from the date of the order.

For stitching and edge colours refer to "colour chart" on inside cover.

FEET:

Standard in hard plastic. On request we supply feet with felt insert for wooden floors.

Reinforced packaging, see inside cover.

Code	Base	Body		pack	m ³	Kg
		Cuoietto (C) hide (!)	"Full-grain" hide (PF) (!)			
05ELE02	Lacquered steel, Polished chrome steel, Black chrome steel			1	0,4	13
	Brass-effect steel, Satin steel					

1 armchair in each package

Optionals

Code	Description	pack	m ³	Kg
02PIE03	Set of felt feet	-	-	-

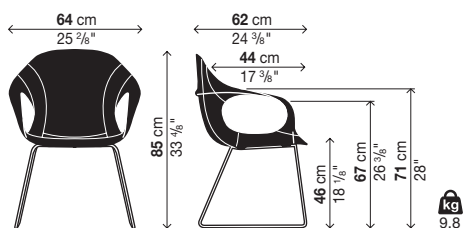

ELEPHANT

Slide frame - Fabric upholstered seat (not removable)

Base finish:

Polished chrome steel
 Black chrome steel
 Satin chrome steel
 Brass-effect steel
 Lacquered steel (in the same colours as the polyurethane)

Finish of cover:

B = COM (Customer fabric)
 D = Remix 2
 E = Canvas 2, Hero, Melange Nap
 F = Regal, Steelcut Trio 3
 G = Divina Melange 3, Hallingdal 65
 H = Twill Weave

Note:

For COM orders see inside cover.

For info on fabric composition, see inside cover.

FEET:

Standard in hard plastic. On request we supply feet with felt insert for wooden floors.

COM consumption: 1,5 ml (H. 140 cm).

Reinforced packaging, see inside cover.

Code	Base	Cover										pack	m ²	Kg		
		A	B	C	D	E	F	G	H	L1	L2				L3	
05ELE52	Lacquered steel, Polished chrome steel, Black chrome steel	-		-							-	-	-	1	0,4	12,5
	Brass-effect steel, Satin steel	-		-							-	-	-			

1 armchair in each package

Optionals

Code	Description	pack	m ²	Kg
02PIE04	Set of felt feet	-	-	-

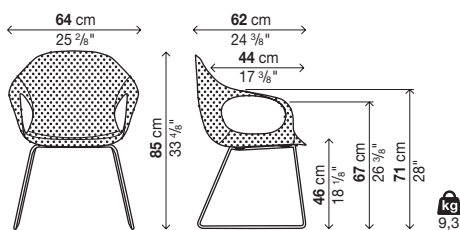

ELEPHANT

Wooden base - Polyurethane seat

Base finish:

Solid beech
 Solid european oak
 Walnut stained solid oak
 Lacquered solid wood (in the same colours as the polyurethane)

Body finish:

White polyurethane (P001)
 Black polyurethane (P003)
 Beige polyurethane (P004)
 Terracotta brown polyurethane (P006)
 Olive green polyurethane (P008)
 Ruby red polyurethane (P010)
 London grey polyurethane (P011)
 Dust blue polyurethane (P012)

Elephant cushion cover finish:

A = Valencia (synthetic leather), COM (Customer fabric)
 B = Field 2
 C = Clara 2, Merit
 D = Curmi, Patio, Remix 2
 E = Canvas 2, Hero, Melange Nap
 F = Regal, Scuba, Steelcut Trio 3
 G = Divina Melange 3, Hallingdal 65
 H = Twill Weave

Lips cushion cover finish:

A = COM (Customer fabric)
 B = Field 2

Note:

For COM orders see inside cover.

For info on fabric composition, see inside cover.

FEET:

Standard in hard plastic. On request we supply feet with felt insert for wooden floors.

SHIPPING INFO PRODUCTS DISASSEMBLED:

For orders of more than 8 units, chairs will be shipped knocked down (only armchairs with polyurethane seat).

- 4 seats = 1 pack - Kg 19 / m³ 0,41

- 4 bases = 1 pack - Kg 12 / m³ 0,33

Elephant cushion consumption: 0,55 ml (H. 140 cm).

Lips cushion consumption: 0,5 ml (H. 140 cm).

Reinforced packaging, see inside cover.

Code	Base	Body		
		pack	m ³	Kg
		Polyurethane		
05ELE82	Beech			
	European oak, Walnut stained oak, Lacquered wood	1	0,4	9,3

1 armchair in each package

Optionals

Code	Description	Cover											pack	m ³	Kg	
		A	B	C	D	E	F	G	H	L1	L2	L3				
20ELE01	Elephant removable cushion (not removable cover)										-	-	-	1	0,02	1
20LIR01	LIPS-R removable cushion (not removable cover)			-	-	-	-	-	-	-	-	-	-	1	0,01	1
20LIS01	LIPS-S removable cushion (not removable cover)			-	-	-	-	-	-	-	-	-	-	1	0,01	1
02PIE05	Set of felt feet															

ELEPHANT (20ELE01)

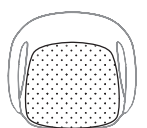

kg
0,6

LIPS-R (20LIR01)

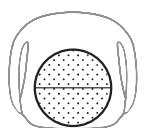

kg
0,6

LIPS-S (20LIS01)

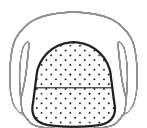

kg
0,6

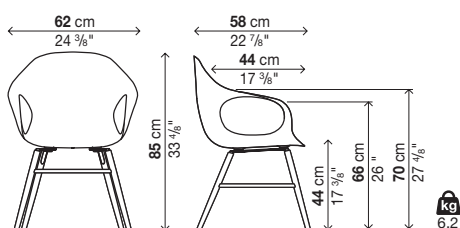

ELEPHANT

Wooden base - Hide upholstered seat (not removable)

Base finish:

Solid beech
 Solid european oak
 Walnut stained solid oak
 Lacquered solid wood (in the same colours as the polyurethane)

Finish of cover:

"Cuoietto" (C) hide
 Natural or black full grain hide (PF)

Note:

Important: sizes and finishes marked with (!) require longer production lead time, about 6 weeks from the date of the order.

For stitching and edge colours refer to "colour chart" on inside cover.

FEET:

Standard in hard plastic. On request we supply feet with felt insert for wooden floors.

Reinforced packaging, see inside cover.

Code	Base	Body		pack	m³	Kg
		Cuoietto (C) hide (!)	"Full-grain" hide (PF) (!)			
05ELE81	Beech			1	0,38	11,2
	European oak, Walnut stained oak, Lacquered wood					

1 armchair in each package

Optionals

Code	Description	pack	m³	Kg
02PIE05	Set of felt feet	-	-	-

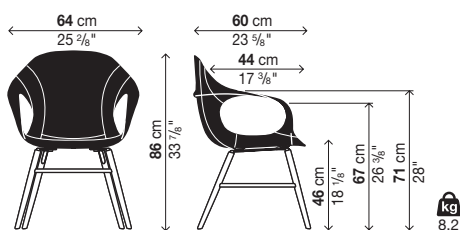

ELEPHANT

Wooden base - Fabric upholstered seat (not removable)

Base finish:

Solid beech
 Solid european oak
 Walnut stained solid oak
 Lacquered solid wood (in the same colours as the polyurethane)

Finish of cover:

B = COM (Customer fabric)
 D = Remix 2
 E = Canvas 2, Hero, Melange Nap
 F = Regal, Steelcut Trio 3
 G = Divina Melange 3, Hallingdal 65
 H = Twill Weave

Note:

For COM orders see inside cover.

For info on fabric composition, see inside cover.

FEET:

Standard in hard plastic. On request we supply feet with felt insert for wooden floors.

COM consumption: 1,5 ml (H. 140 cm).

Reinforced packaging, see inside cover.

Code	Base	Cover											pack	m ³	Kg	
		A	B	C	D	E	F	G	H	L1	L2	L3				
05ELE53	Beech	-		-							-	-	-	1	0,4	10,7
	European oak, Walnut stained oak, Lacquered wood	-		-							-	-	-			

1 armchair in each package

Optionals

Code	Description	pack	m ³	Kg
02PIE05	Set of felt feet	-	-	-

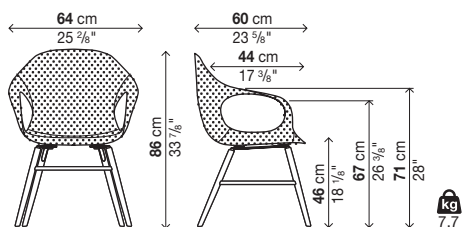

ELEPHANT

Rocking - Polyurethane seat

Base finish:

Solid beech
Solid european oak
Walnut stained solid oak
Lacquered solid wood (in the same colours as the polyurethane)

Body finish:

White polyurethane (P001)
Black polyurethane (P003)
Beige polyurethane (P004)
Terracotta brown polyurethane (P006)
Olive green polyurethane (P008)
Ruby red polyurethane (P010)
London grey polyurethane (P011)
Dust blue polyurethane (P012)

Elephant cushion cover finish:

A = Valencia (synthetic leather), COM (Customer fabric)
B = Field 2
C = Clara 2, Merit
D = Curmi, Patio, Remix 2
E = Canvas 2, Hero, Melange Nap
F = Regal, Scuba, Steelcut Trio 3
G = Divina Melange 3, Hallingdal 65
H = Twill Weave

Lips cushion cover finish:

A = COM (Customer fabric)
B = Field 2

Note:

For COM orders see inside cover.

For info on fabric composition, see inside cover.

SHIPPING INFO PRODUCTS DISASSEMBLED:

For orders of more than 8 units, chairs will be shipped knocked down (only armchairs with polyurethane seat).
- 4 seats = 1 pack - Kg 19 / m³ 0,41
- 2 bases = 1 pack - Kg 10 / m³ 0,34

Elephant cushion consumption: 0,55 ml (H. 140 cm).

Lips cushion consumption: 0,5 ml (H. 140 cm).

Reinforced packaging, see inside cover.

Code	Base	Body	
			pack m ³ Kg
		Polyurethane	
05ELE91	Beech		
	European oak, Walnut stained oak, Lacquered wood		1 0,56 12

1 armchair in each package

Optionals

Code	Description	Cover										pack m ³ Kg		
		A	B	C	D	E	F	G	H	L1	L2		L3	
20ELE01	Elephant removable cushion (not removable cover)										-	-	-	1 0,02 1
20LIR01	LIPS-R removable cushion (not removable cover)			-	-	-	-	-	-	-	-	-	-	1 0,01 1
20LIS01	LIPS-S removable cushion (not removable cover)			-	-	-	-	-	-	-	-	-	-	1 0,01 1

ELEPHANT (20ELE01)

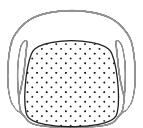

kg
0,6

LIPS-R (20LIR01)

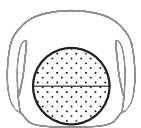

kg
0,6

LIPS-S (20LIS01)

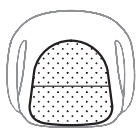

kg
0,6

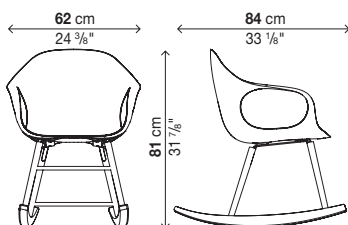

ELEPHANT

Rocking - Hide upholstered seat (not removable)

Base finish:

Solid beech
 Solid european oak
 Walnut stained solid oak
 Lacquered solid wood (in the same colours as the polyurethane)

Finish of cover:

"Cuoietto" (C) hide
 Natural or black full grain hide (PF)

Note:

Important: sizes and finishes marked with (!) require longer production lead time, about 6 weeks from the date of the order.

For stitching and edge colours refer to "colour chart" on inside cover.

Reinforced packaging, see inside cover.

Code	Base	Body		pack	m ³	Kg
		Cuoietto (C) hide (!)	"Full-grain" hide (PF) (!)			
05ELE92	Beech			1	0,56	14
	European oak, Walnut stained oak, Lacquered wood					

1 armchair in each package

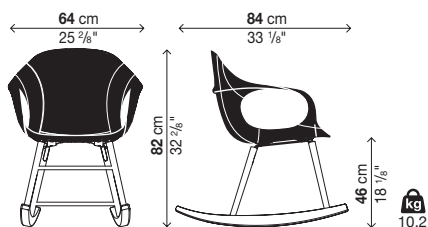

ELEPHANT

Rocking - Fabric upholstered seat (not removable)

Base finish:

Solid beech
 Solid european oak
 Walnut stained solid oak
 Lacquered solid wood (in the same colours as the polyurethane)

Finish of cover:

B = COM (Customer fabric)
 D = Remix 2
 E = Canvas 2, Hero, Melange Nap
 F = Regal, Steelcut Trio 3
 G = Divina Melange 3, Hallingdal 65
 H = Twill Weave

Note:

For COM orders see inside cover.
 For info on fabric composition, see inside cover.
 COM consumption: 1,5 ml (H. 140 cm).
 Reinforced packaging, see inside cover.

Code	Base	Cover										pack	m ³	Kg	
		A	B	C	D	E	F	G	H	L1	L2				L3
05ELE93	Beech	-		-						-	-	-	1	0,56	13,5
	European oak, Walnut stained oak, Lacquered wood	-		-						-	-	-			

1 armchair in each package

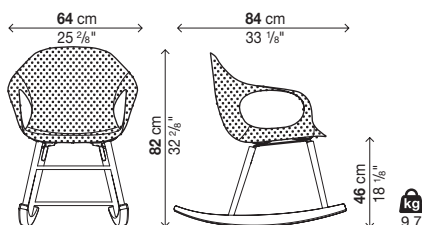

ELEPHANT

Swivel trestle - Polyurethane seat

Base finish:

Polished aluminium

Lacquered aluminium (in the same colours as the polyurethane)

Body finish:

White polyurethane (P001)

Black polyurethane (P003)

Beige polyurethane (P004)

Terracotta brown polyurethane (P006)

Olive green polyurethane (P008)

Ruby red polyurethane (P010)

London grey polyurethane (P011)

Dust blue polyurethane (P012)

Elephant cushion cover finish:

A = Valencia (synthetic leather), COM (Customer fabric)

B = Field 2

C = Clara 2, Merit

D = Curmi, Patio, Remix 2

E = Canvas 2, Hero, Melange Nap

F = Regal, Scuba, Steelcut Trio 3

G = Divina Melange 3, Hallingdal 65

H = Twill Weave

Lips cushion cover finish:

A = COM (Customer fabric)

B = Field 2

Note:

For COM orders see inside cover.

For info on fabric composition, see inside cover.

FEET:

Standard with felt insert for wooden floors.

SHIPPING INFO PRODUCTS DISASSEMBLED:

For orders of more than 8 units, chairs will be shipped knocked down (only armchairs with polyurethane seat).

- 4 seats = 1 pack - Kg 19 / m³ 0,41

- 1 bases = 1 pack - Kg 6 / m³ 0,14

Elephant cushion consumption: 0,55 ml (H. 140 cm).

Lips cushion consumption: 0,5 ml (H. 140 cm).

Reinforced packaging, see inside cover.

Code	Base	Body		pack	m ³	Kg
			Polyurethane			
05ELE72	Lacquered aluminium			1	0,38	11,5
	Polished aluminium					

1 armchair in each package

Optionals

Code	Description	Cover											pack	m ³	Kg			
		A	B	C	D	E	F	G	H	L1	L2	L3						
20ELE01	Elephant removable cushion (not removable cover)												-	-	-	1	0,02	1
20LIR01	LIPS-R removable cushion (not removable cover)			-	-	-	-	-	-	-	-	-	-	-	-	1	0,01	1
20LIS01	LIPS-S removable cushion (not removable cover)			-	-	-	-	-	-	-	-	-	-	-	-	1	0,01	1

ELEPHANT (20ELE01)

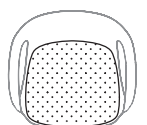

LIPS-R (20LIR01)

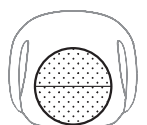

LIPS-S (20LIS01)

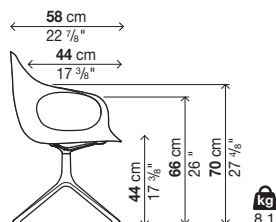
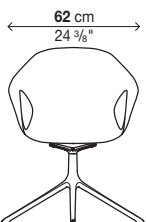
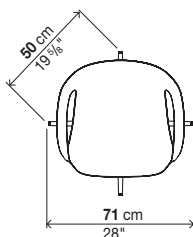
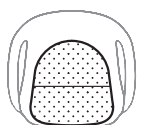

ELEPHANT

Swivel trestle - Hide upholstered seat (not removable)

Base finish:

Polished aluminium
Lacquered aluminium (in the same colours as the polyurethane)

Finish of cover:

"Cuoietto" (C) hide
Natural or black full grain hide (PF)

Note:

Important: sizes and finishes marked with (!) require longer production lead time, about 6 weeks from the date of the order.

For stitching and edge colours refer to "colour chart" on inside cover.

FEET:

Standard with felt insert for wooden floors.

Reinforced packaging, see inside cover.

Code	Base	Body		pack	m ³	Kg
		Cuoietto (C) hide (!)	"Full-grain" hide (PF) (!)			
05ELE71	Lacquered aluminium			1	0,38	14
	Polished aluminium					

1 armchair in each package

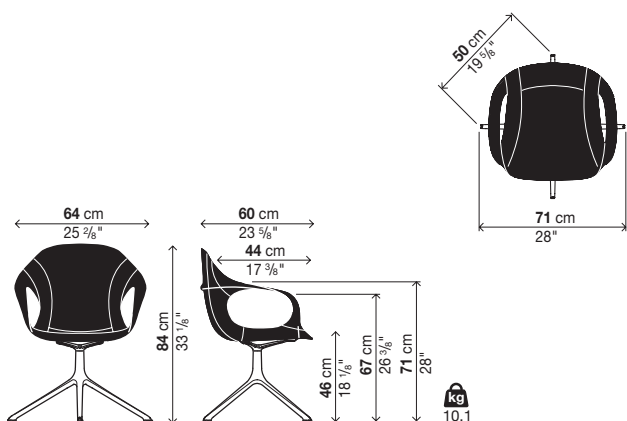

ELEPHANT

Swivel trestle - Fabric upholstered seat (not removable)

Base finish:

Polished aluminium

Lacquered aluminium (in the same colours as the polyurethane)

Finish of cover:

B = COM (Customer fabric)

D = Remix 2

E = Canvas 2, Hero, Melange Nap

F = Regal, Steelcut Trio 3

G = Divina Melange 3, Hallingdal 65

H = Twill Weave

Note:

For COM orders see inside cover.

For info on fabric composition, see inside cover.

FEET:

Standard with felt insert for wooden floors.

COM consumption: 1,5 ml (H. 140 cm).

Reinforced packaging, see inside cover.

Code	Base	Cover											pack	m ²	Kg	
		A	B	C	D	E	F	G	H	L1	L2	L3				
05ELE54	Lacquered aluminium	-		-							-	-	-	1	0,38	13,5
	Polished aluminium	-		-							-	-	-			

1 armchair in each package

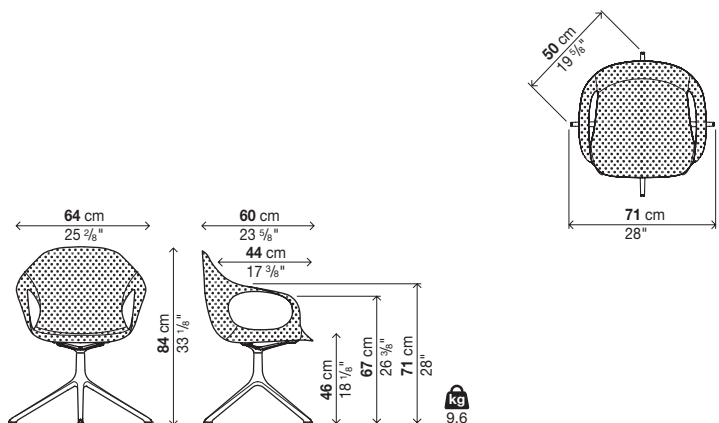

ELEPHANT

5 spoke base with castors - Polyurethane seat

Base finish:

Polished aluminium
Lacquered aluminium (white, black)

Body finish:

White polyurethane (P001)
Black polyurethane (P003)
Beige polyurethane (P004)
Terracotta brown polyurethane (P006)
Olive green polyurethane (P008)
Ruby red polyurethane (P010)
London grey polyurethane (P011)
Dust blue polyurethane (P012)

Elephant cushion cover finish:

A = Valencia (synthetic leather), COM (Customer fabric)
B = Field 2
C = Clara 2, Merit
D = Curmi, Patio, Remix 2
E = Canvas 2, Hero, Melange Nap
F = Regal, Scuba, Steelcut Trio 3
G = Divina Melange 3, Hallingdal 65
H = Twill Weave

Lips cushion cover finish:

A = COM (Customer fabric)
B = Field 2

Note:

For COM orders see inside cover.

For info on fabric composition, see inside cover.

Soft tread, self-locking swivel castors.

SHIPPING INFO PRODUCTS DISASSEMBLED:

For orders of more than 8 units, chairs will be shipped knocked down (only armchairs with polyurethane seat).

- 4 seats = 1 pack - Kg 19 / m³ 0,41
- 1 bases = 1 pack - Kg 15 / m³ 0,14

Elephant cushion consumption: 0,55 ml (H. 140 cm).

Lips cushion consumption: 0,5 ml (H. 140 cm).

Reinforced packaging, see inside cover.

Code	Base	Body		
		pack	m ³	Kg
		Polyurethane		
05ELE41	Lacquered aluminium	1	0,38	13
	Polished aluminium			

1 armchair in each package

Optionals

Code	Description	Cover											pack	m ³	Kg		
		A	B	C	D	E	F	G	H	L1	L2	L3					
20ELE01	Elephant removable cushion (not removable cover)											-	-	-	1	0,02	1
20LIR01	LIPS-R removable cushion (not removable cover)			-	-	-	-	-	-	-	-	-	-	-	1	0,01	1
20LIS01	LIPS-S removable cushion (not removable cover)			-	-	-	-	-	-	-	-	-	-	-	1	0,01	1

ELEPHANT (20ELE01)

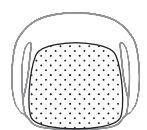

kg
0,6

LIPS-R (20LIR01)

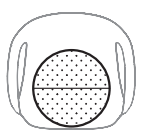

kg
0,6

LIPS-S (20LIS01)

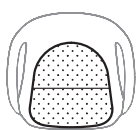

kg
0,6

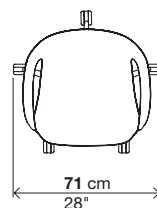

62 cm
24 3/8"

58 cm
22 7/8"

44 cm
17 3/8"

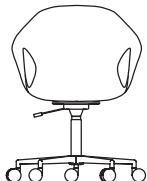

81/90 cm
31 7/8 / 35 5/8"



42/51 cm
16 1/8 / 20 1/8"



64/73 cm
25 1/8 / 28 3/8"

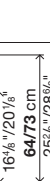

68/77 cm
26 3/8 / 30 3/8"

kg
9,5

ELEPHANT

5 spoke base with castors - Hide upholstered seat (not removable)

Base finish:

Polished aluminium
Lacquered aluminium (white, black)

Finish of cover:

"Cuoietto" (C) hide
Natural or black full grain hide (PF)

Note:

Important: sizes and finishes marked with (!) require longer production lead time, about 6 weeks from the date of the order.

For stitching and edge colours refer to "colour chart" on inside cover.

Soft tread, self-locking swivel castors.

Reinforced packaging, see inside cover.

Code	Base	Body		pack	m ³	Kg
		Cuoietto (C) hide (!)	"Full-grain" hide (PF) (!)			
05ELE42	Lacquered aluminium			1	0,38	15,5
	Polished aluminium					

1 armchair in each package

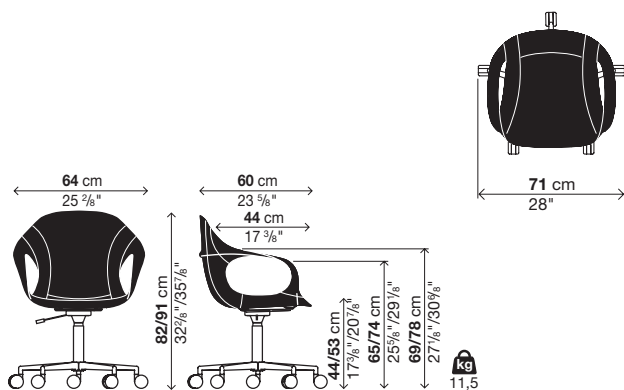

ELEPHANT

5 spoke base with castors - Fabric upholstered seat (not removable)

Base finish:

Polished aluminium
Lacquered aluminium (white, black)

Finish of cover:

B = COM (Customer fabric)
D = Remix 2
E = Canvas 2, Hero, Melange Nap
F = Regal, Steelcut Trio
G = Divina Melange 3, Hallingdal 65
H = Twill Weave

Note:

For COM orders see inside cover.

For info on fabric composition, see inside cover.

Soft tread, self-locking swivel castors.

COM consumption: 1,5 ml (H. 140 cm).

Reinforced packaging, see inside cover.

Code	Base	Cover										pack	m ²	Kg		
		A	B	C	D	E	F	G	H	L1	L2				L3	
05ELE43	Lacquered aluminium	-		-							-	-	-	1	0,38	15
	Polished aluminium	-		-							-	-	-			

1 armchair in each package

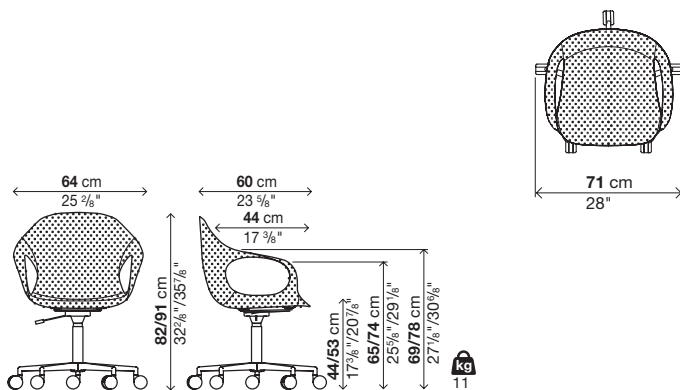

ELEPHANT

Armchair lounge - Polyurethane seat

Base finish:

Polished chrome steel
 Black chrome steel
 Brass-effect steel
 Lacquered steel (in the same colour as the polyurethane)

Body finish:

White polyurethane (P001)
 Black polyurethane (P003)
 Beige polyurethane (P004)
 Terracotta brown polyurethane (P006)
 Olive green polyurethane (P008)
 Ruby red polyurethane (P010)
 London grey polyurethane (P011)
 Dust blue polyurethane (P012)

Elephant cushion cover finish:

A = Valencia (synthetic leather), COM (Customer fabric)
 B = Field 2
 C = Clara 2, Merit
 D = Curmi, Patio, Remix 2
 E = Canvas 2, Hero, Melange Nap
 F = Regal, Scuba, Steelcut Trio 3
 G = Divina Melange 3, Hallingdal 65
 H = Twill Weave

Lips cushion cover finish:

A = COM (Customer fabric)
 B = Field 2

Note:

For COM orders see inside cover.

For info on fabric composition, see inside cover.

FEET:

Standard in hard plastic. On request we supply feet with felt insert for wooden floors.

SHIPPING INFO PRODUCTS DISASSEMBLED:

For orders of more than 8 units, chairs will be shipped knocked down (only armchairs with polyurethane seat).

- 4 seats = 1 pack - Kg 19 / m³ 0,41

- 4 bases = 1 pack - Kg 14 / m³ 0,28

Elephant cushion consumption: 0,55 ml (H. 140 cm).

Lips cushion consumption: 0,5 ml (H. 140 cm).

Reinforced packaging, see inside cover.

Code	Base	Body		
		pack	m ³	Kg
		Polyurethane		
05ELE03	Lacquered steel, Polished chrome steel, Black chrome steel	1	0,4	10
	Brass-effect steel			

1 armchair in each package

Optionals

Code	Description	Cover										pack	m ³	Kg		
		A	B	C	D	E	F	G	H	L1	L2				L3	
20ELE01	Elephant removable cushion (not removable cover)										-	-	-	1	0,02	1
20LIR01	LIPS-R removable cushion (not removable cover)			-	-	-	-	-	-	-	-	-	-	1	0,01	1
20LIS01	LIPS-S removable cushion (not removable cover)			-	-	-	-	-	-	-	-	-	-	1	0,01	1
02PIE14	Set of felt feet													-	-	-

ELEPHANT (20ELE01)

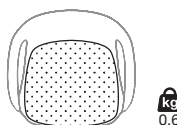

LIPS-R (20LIR01)

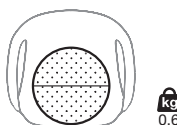

LIPS-S (20LIS01)

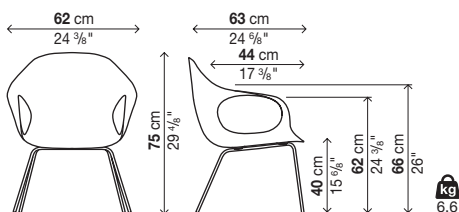

ELEPHANT

Armchair lounge - Hide upholstered seat (not removable)

Base finish:

Polished chrome steel
 Black chrome steel
 Brass-effect steel
 Lacquered steel (in the same colour as the polyurethane)

Finish of cover:

"Cuoietto" (C) hide
 Natural or black full grain hide (PF)

Note:

Important: sizes and finishes marked with (!) require longer production lead time, about 6 weeks from the date of the order.

For stitching and edge colours refer to "colour chart" on inside cover.

Reinforced packaging, see inside cover.

Code	Base	Body		pack	m ²	Kg
		Cuoietto (C) hide (!)	"Full-grain" hide (PF) (!)			
05ELE13	Lacquered steel, Polished chrome steel, Black chrome steel			1	0,4	11,5
	Brass-effect steel					

1 armchair in each package

Optionals

Code	Description	pack	m ²	Kg
02PIE14	Set of felt feet	-	-	-

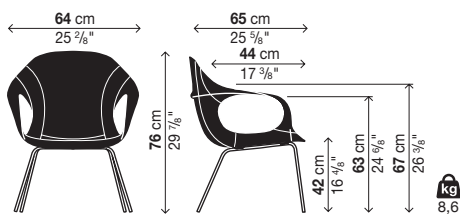

ELEPHANT

Armchair lounge - Fabric upholstered seat (not removable)

Base finish:

Polished chrome steel
 Black chrome steel
 Brass-effect steel
 Lacquered steel (in the same colours as the polyurethane)

Finish of cover:

B = COM (Customer fabric)
 D = Remix 2
 E = Canvas 2, Hero, Melange Nap
 F = Regal, Steelcut Trio 3
 G = Divina Melange 3, Hallingdal 65
 H = Twill Weave

Note:

For COM orders see inside cover.

For info on fabric composition, see inside cover.

FEET:

Standard in hard plastic. On request we supply feet with felt insert for wooden floors.

COM consumption: 1,5 ml (H. 140 cm).

Reinforced packaging, see inside cover.

Code	Base	Cover										pack	m ³	Kg	
		A	B	C	D	E	F	G	H	L1	L2				L3
05ELE23	Lacquered steel, Polished chrome steel, Black chrome steel	-		-						-	-	-	1	0,4	11
	Brass-effect steel	-		-						-	-	-			

1 armchair in each package

Optionals

Code	Description	pack	m ³	Kg
02PIE14	Set of felt feet	-	-	-

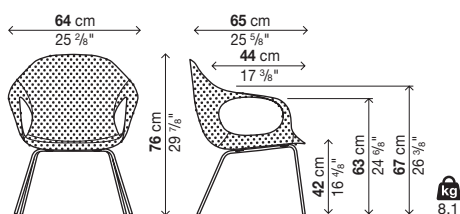

ELEPHANT

Legenda

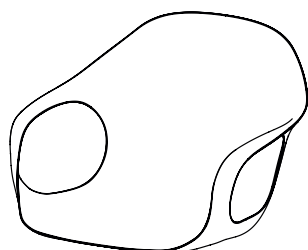
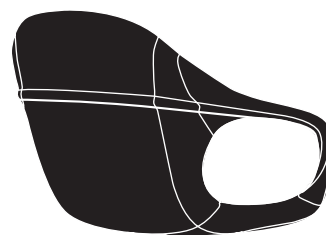

Scocca in poliuretano

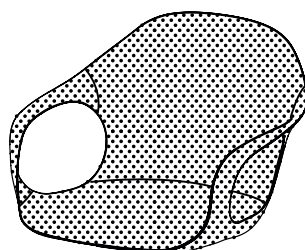

Scocca rivestita in tessuto

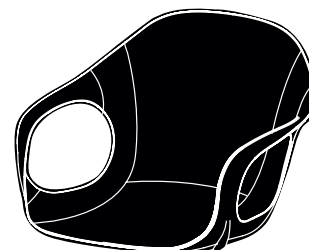

Scocca rivestita in cuoio



Quattro gambe

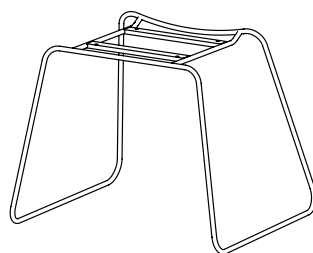

Slitta

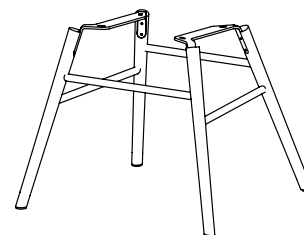

Base legno

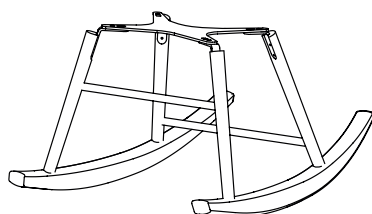

Rocking

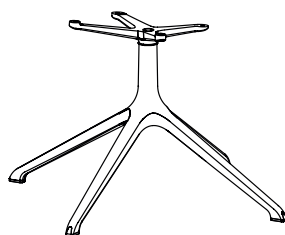

Trespole girevole

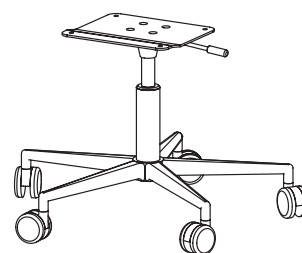

Cinque razze

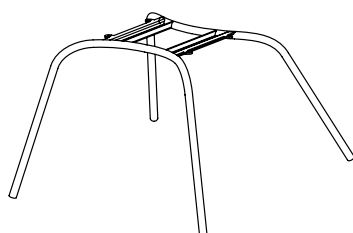

Lounge

ELEPHANT

Quattro gambe - Scocca in poliuretano

Finitura base:

Acciaio cromato
 Acciaio cromato nero
 Acciaio cromato satinato
 Acciaio effetto ottone
 Acciaio verniciato (nei colori del poliuretano)

Finitura scocca:

Poliuretano bianco (P001)
 Poliuretano nero (P003)
 Poliuretano beige (P004)
 Poliuretano terracotta (P006)
 Poliuretano verde oliva (P008)
 Poliuretano rosso rubino (P010)
 Poliuretano grigio Londra (P011)
 Poliuretano blu polvere (P012)

Finitura rivestimento cuscino Elephant:

A = Valencia (pelle sintetica), COM (tessuto Cliente)
 B = Field 2
 C = Clara 2, Merit
 D = Curmi, Patio, Remix 2
 E = Canvas 2, Hero, Melange Nap
 F = Regal, Scuba, Steelcut Trio 3
 G = Divina Melange 3, Hallingdal 65
 H = Twill Weave

Finitura rivestimento cuscino Lips:

A = COM (tessuto Cliente)
 B = Field 2

Note:

Per ordini COM vedi interno di copertina.

Per informazioni su composizioni tessuti vedi interno di copertina.

PIEDINI:

Di serie in plastica dura. Su richiesta vengono forniti piedini con inserto in feltro per pavimenti in legno.

INFO SPEDIZIONI SMONTATO:

Per ordini superiori alle 8 unità, il prodotto viene spedito smontato (solo per poltroncine con scocca in poliuretano).

- 4 scocche = 1 collo - Kg 19 / m³ 0,41.

- 4 basi = 1 collo - Kg 14 / m³ 0,26.

Consumo cuscino Elephant: 0,55 ml (H. 140 cm).

Consumo cuscino Lips: 0,5 ml (H. 140 cm).

Imballi rinforzati vedi interno di copertina.

Codice	Base	Scocca	colli	m ³	Kg
		Poliuretano			
05ELE11	Acciaio verniciato, Acciaio cromato, Acciaio cromato nero		1	0,4	10
	Acciaio effetto ottone, Acciaio satinato				

ogni collo contiene 1 poltroncina

Optionals

Codice	Descrizione	Rivestimento											colli	m ³	Kg		
		A	B	C	D	E	F	G	H	L1	L2	L3					
20ELE01	Cuscino rimovibile Elephant (non sfoderabile)											-	-	-	1	0,02	1
20LIR01	Cuscino rimovibile LIPS-R (non sfoderabile)			-	-	-	-	-	-	-	-	-	-	-	1	0,01	1
20LIS01	Cuscino rimovibile LIPS-S (non sfoderabile)			-	-	-	-	-	-	-	-	-	-	-	1	0,01	1
02PIE03	Set di piedini in feltro														-	-	-

ELEPHANT (20ELE01)

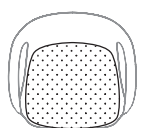

LIPS-R (20LIR01)

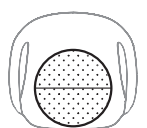

LIPS-S (20LIS01)

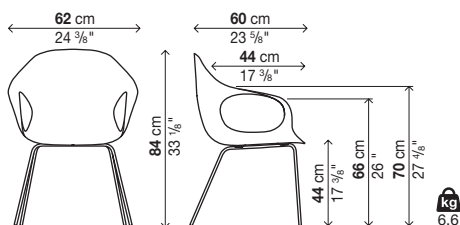
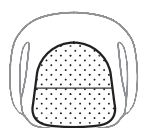

ELEPHANT

Quattro gambe - Scocca rivestita in cuoio (non sfoderabile)

Finitura base:

Acciaio cromato
 Acciaio cromato nero
 Acciaio cromato satinato
 Acciaio effetto ottone
 Acciaio verniciato (nei colori del poliuretano)

Finitura rivestimento:

Cuoietto (C)
 Cuoio "pieno fiore" (PF) naturale o nero

Note:

Attenzione: le misure o le finiture contrassegnate con (!) hanno tempi di produzione più lunghi, circa 6 settimane dalla data dell'ordine.

Per colori cuciture e bordi vedi "regole cuoio" interno di copertina.

PIEDINI:

Di serie in plastica dura. Su richiesta vengono forniti piedini con inserto in feltro per pavimenti in legno.

Imballi rinforzati vedi interno di copertina.

Codice	Base	Scocca		colli	m ³	Kg
		Cuoietto (C) (!)	Cuoio "pieno fiore" (PF) (!)			
05ELE01	Acciaio verniciato, Acciaio cromato, Acciaio cromato nero			1	0,4	11,5
	Acciaio effetto ottone, Acciaio satinato					

ogni collo contiene 1 poltroncina

Optionals

Codice	Descrizione	colli	m ³	Kg
02PIE03	Set di piedini in feltro	-	-	-

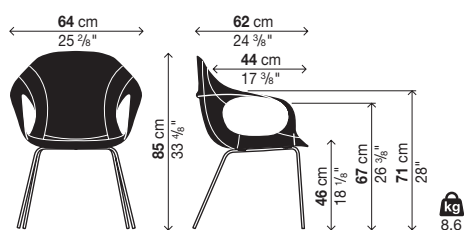

ELEPHANT

Quattro gambe - Scocca rivestita in tessuto (non sfoderabile)

Finitura base:

Acciaio cromato
 Acciaio cromato nero
 Acciaio cromato satinato
 Acciaio effetto ottone
 Acciaio verniciato (nei colori del poliuretano)

Finitura rivestimento:

B = COM (tessuto Cliente)
 D = Remix 2
 E = Canvas 2, Hero, Melange Nap
 F = Regal, Steelcut Trio 3
 G = Divina Melange 3, Hallingdal 65
 H = Twill Weave

Note:

Per ordini COM vedi interno di copertina.

Per informazioni su composizioni tessuti vedi interno di copertina.

PIEDINI:

Di serie in plastica dura. Su richiesta vengono forniti piedini con inserto in feltro per pavimenti in legno.

Consumo COM: 1,5 ml (H. 140 cm).

Imballi rinforzati vedi interno di copertina.

Codice	Base	Rivestimento											colli	m ²	Kg	
		A	B	C	D	E	F	G	H	L1	L2	L3				
05ELE51	Acciaio verniciato, Acciaio cromato, Acciaio cromato nero	-		-							-	-	-	1	0,4	11
	Acciaio effetto ottone, Acciaio satinato	-		-							-	-	-			

ogni collo contiene 1 poltroncina

Optionals

Codice	Descrizione	colli	m ²	Kg
02PIE03	Set di piedini in feltro	-	-	-

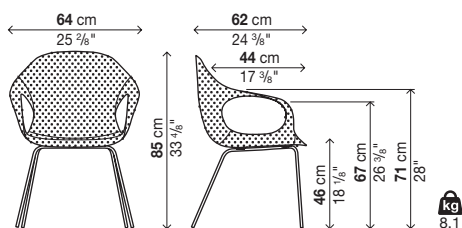

ELEPHANT

Slitta - Scocca in poliuretano

Finitura base:

Acciaio cromato
 Acciaio cromato nero
 Acciaio cromato satinato
 Acciaio effetto ottone
 Acciaio verniciato (nei colori del poliuretano)

Finitura scocca:

Poliuretano bianco (P001)
 Poliuretano nero (P003)
 Poliuretano beige (P004)
 Poliuretano terracotta (P006)
 Poliuretano verde oliva (P008)
 Poliuretano rosso rubino (P010)
 Poliuretano grigio Londra (P011)
 Poliuretano blu polvere (P012)

Finitura rivestimento cuscino Elephant:

A = Valencia (pelle sintetica), COM (tessuto Cliente)
 B = Field 2
 C = Clara 2, Merit
 D = Curmi, Patio, Remix 2
 E = Canvas 2, Hero, Melange Nap
 F = Regal, Scuba, Steelcut Trio 3
 G = Divina Melange 3, Hallingdal 65
 H = Twill Weave

Finitura rivestimento cuscino Lips:

A = COM (tessuto Cliente)
 B = Field 2

Note:

Per ordini COM vedi interno di copertina.

Per informazioni su composizioni tessuti vedi interno di copertina.

PIEDINI:

Di serie in plastica dura. Su richiesta vengono forniti piedini con inserto in feltro per pavimenti in legno.

INFO SPEDIZIONI SMONTATO:

Per ordini superiori alle 8 unità, il prodotto viene spedito smontato (solo per poltroncine con scocca in poliuretano).

- 4 scocche = 1 collo - Kg 19 / m³ 0,41
 - 4 basi = 1 collo - Kg 19 / m³ 0,26

Consumo cuscino Elephant: 0,55 ml (H. 140 cm).

Consumo cuscino Lips: 0,5 ml (H. 140 cm).

Imballi rinforzati vedi interno di copertina.

Codice	Base	Scocca		
		colli	m ³	Kg
		Poliuretano		
05ELE12	Acciaio verniciato, Acciaio cromato, Acciaio cromato nero	1	0,4	11,2
	Acciaio effetto ottone, Acciaio satinato			

ogni collo contiene 1 poltroncina

Optionals

Codice	Descrizione	Rivestimento										colli	m ³	Kg		
		A	B	C	D	E	F	G	H	L1	L2				L3	
20ELE01	Cuscino rimovibile Elephant (non sfoderabile)										-	-	-	1	0,02	1
20LIR01	Cuscino rimovibile LIPS-R (non sfoderabile)			-	-	-	-	-	-	-	-	-	-	1	0,01	1
20LIS01	Cuscino rimovibile LIPS-S (non sfoderabile)			-	-	-	-	-	-	-	-	-	-	1	0,01	1
02PIE03	Set di piedini in feltro													-	-	-

ELEPHANT (20ELE01)

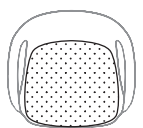

LIPS-R (20LIR01)

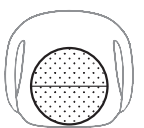

LIPS-S (20LIS01)

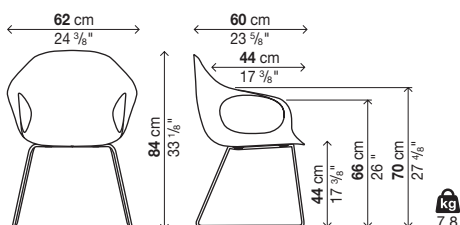
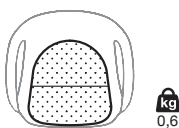

ELEPHANT

Slitta - Scocca rivestita in cuoio (non sfoderabile)

Finitura base:

Acciaio cromato
 Acciaio cromato nero
 Acciaio cromato satinato
 Acciaio effetto ottone
 Acciaio verniciato (nei colori del poliuretano)

Finitura rivestimento:

Cuoietto (C)
 Cuoio "pieno fiore" (PF) naturale o nero

Note:

Attenzione: le misure o le finiture contrassegnate con (!) hanno tempi di produzione più lunghi, circa 6 settimane dalla data dell'ordine.

Per colori cuciture e bordi vedi "regole cuoio" interno di copertina.

PIEDINI:

Di serie in plastica dura. Su richiesta vengono forniti piedini con inserto in feltro per pavimenti in legno.

Imballi rinforzati vedi interno di copertina.

Codice	Base	Scocca		colli	m ³	Kg
		Cuoietto (C) (!)	Cuoio "pieno fiore" (PF) (!)			
05ELE02	Acciaio verniciato, Acciaio cromato, Acciaio cromato nero			1	0,4	13
	Acciaio effetto ottone, Acciaio satinato					

ogni collo contiene 1 poltroncina

Optionals

Codice	Descrizione	colli	m ³	Kg
02PIE03	Set di piedini in feltro	-	-	-

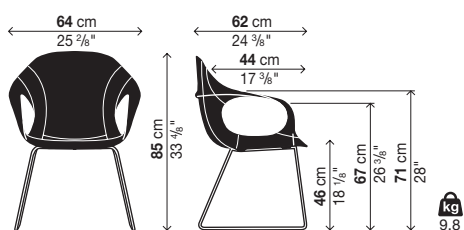

ELEPHANT

Slitta - Scocca rivestita in tessuto (non sfoderabile)

Finitura base:

Acciaio cromato
 Acciaio cromato nero
 Acciaio cromato satinato
 Acciaio effetto ottone
 Acciaio verniciato (nei colori del poliuretano)

Finitura rivestimento:

B = COM (tessuto Cliente)
 D = Remix 2
 E = Canvas 2, Hero, Melange Nap
 F = Regal, Steelcut Trio 3
 G = Divina Melange 3, Hallingdal 65
 H = Twill Weave

Note:

Per ordini COM vedi interno di copertina.

Per informazioni su composizioni tessuti vedi interno di copertina.

PIEDINI:

Di serie in plastica dura. Su richiesta vengono forniti piedini con inserto in feltro per pavimenti in legno.

Consumo COM: 1,5 ml (H. 140 cm).

Imballi rinforzati vedi interno di copertina.

Codice	Base	Rivestimento										colli	m ²	Kg		
		A	B	C	D	E	F	G	H	L1	L2				L3	
05ELE52	Acciaio verniciato, Acciaio cromato, Acciaio cromato nero	-		-							-	-	-	1	0,4	12,5
	Acciaio effetto ottone, Acciaio satinato	-		-							-	-	-			

ogni collo contiene 1 poltroncina

Optionals

Codice	Descrizione	colli	m ²	Kg
02PIE04	Set di piedini in feltro	-	-	-

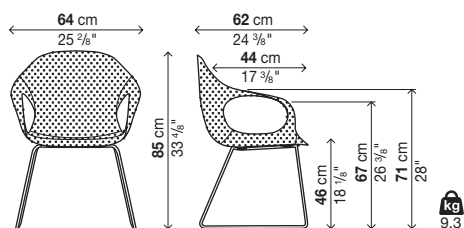

ELEPHANT

Base legno - Scocca in poliuretano

Finitura base:

Legno massello di faggio
 Legno massello di rovere europeo
 Legno massello di rovere tinto noce
 Legno massello verniciato (nei colori del poliuretano)

Finitura scocca:

Poliuretano bianco (P001)
 Poliuretano nero (P003)
 Poliuretano beige (P004)
 Poliuretano terracotta (P006)
 Poliuretano verde oliva (P008)
 Poliuretano rosso rubino (P010)
 Poliuretano grigio Londra (P011)
 Poliuretano blu polvere (P012)

Finitura rivestimento cuscino Elephant:

A = Valencia (pelle sintetica), COM (tessuto Cliente)
 B = Field 2
 C = Clara 2, Merit
 D = Curmi, Patio, Remix 2
 E = Canvas 2, Hero, Melange Nap
 F = Regal, Scuba, Steelcut Trio 3
 G = Divina Melange 3, Hallingdal 65
 H = Twill Weave

Finitura rivestimento cuscino Lips:

A = COM (tessuto Cliente)
 B = Field 2

Note:

Per ordini COM vedi interno di copertina.

Per informazioni su composizioni tessuti vedi interno di copertina.

PIEDINI:

Di serie in plastica dura. Su richiesta vengono forniti piedini con inserto in feltro per pavimenti in legno.

INFO SPEDIZIONI SMONTATO:

Per ordini superiori alle 8 unità, il prodotto viene spedito smontato (solo per poltroncine con scocca in poliuretano).

- 4 scocche = 1 collo - Kg 19 / m³ 0,41

- 4 basi = 1 collo - Kg 12 / m³ 0,33

Consumo cuscino Elephant: 0,55 ml (H. 140 cm).

Consumo cuscino Lips: 0,5 ml (H. 140 cm).

Imballi rinforzati vedi interno di copertina.

Codice	Base	Scocca		
		colli	m ³	Kg
		Poliuretano		
05ELE82	Faggio			
	Rovere europeo, Rovere tinto noce, Legno verniciato	1	0,4	9,3

ogni collo contiene 1 poltroncina

Optionals

Codice	Descrizione	Rivestimento											colli	m ³	Kg	
		A	B	C	D	E	F	G	H	L1	L2	L3				
20ELE01	Cuscino rimovibile Elephant (non sfoderabile)										-	-	-	1	0,02	1
20LIR01	Cuscino rimovibile LIPS-R (non sfoderabile)			-	-	-	-	-	-	-	-	-	-	1	0,01	1
20LIS01	Cuscino rimovibile LIPS-S (non sfoderabile)			-	-	-	-	-	-	-	-	-	-	1	0,01	1
02PIE05	Set di piedini in feltro															

ELEPHANT (20ELE01)

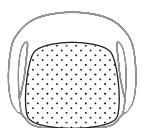

kg
0,6

LIPS-R (20LIR01)

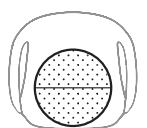

kg
0,6

LIPS-S (20LIS01)



kg
0,6

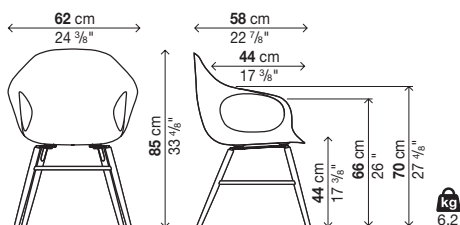

ELEPHANT

Base legno - Scocca rivestita in cuoio (non sfoderabile)

Finitura base:

Legno massello di faggio
 Legno massello di rovere europeo
 Legno massello di rovere tinto noce
 Legno massello verniciato (nei colori del poliuretano)

Finitura rivestimento:

Cuoietto (C)
 Cuoio "pieno fiore" (PF) naturale o nero

Note:

Attenzione: le misure o le finiture contrassegnate con (!) hanno tempi di produzione più lunghi, circa 6 settimane dalla data dell'ordine.

Per colori cuciture e bordi vedi "regole cuoio" interno di copertina.

PIEDINI:

Di serie in plastica dura. Su richiesta vengono forniti piedini con inserto in feltro per pavimenti in legno.

Imballi rinforzati vedi interno di copertina.

Codice	Base	Scocca		colli	m ²	Kg
		Cuoietto (C) (!)	Cuoio "pieno fiore" (PF) (!)			
05ELE81	Faggio			1	0,38	11,2
	Rovere europeo, Rovere tinto noce, Legno verniciato					

ogni collo contiene 1 poltroncina

Optionals

Codice	Descrizione	colli	m ²	Kg
02PIE05	Set di piedini in feltro	-	-	-

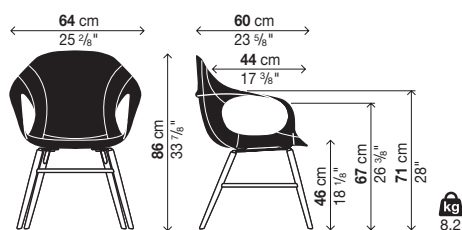

ELEPHANT

Base legno - Scocca rivestita in tessuto (non sfoderabile)

Finitura base:

Legno massello di faggio
 Legno massello di rovere europeo
 Legno massello di rovere tinto noce
 Legno massello verniciato (nei colori del poliuretano)

Finitura rivestimento:

B = COM (tessuto Cliente)
 D = Remix 2
 E = Canvas 2, Hero, Melange Nap
 F = Regal, Steelcut Trio 3
 G = Divina Melange 3, Hallingdal 65
 H = Twill Weave

Note:

Per ordini COM vedi interno di copertina.

Per informazioni su composizioni tessuti vedi interno di copertina.

PIEDINI:

Di serie in plastica dura. Su richiesta vengono forniti piedini con inserto in feltro per pavimenti in legno.

Consumo COM: 1,5 ml (H. 140 cm).

Imballi rinforzati vedi interno di copertina.

Codice	Base	Rivestimento											colli	m ³	Kg	
		A	B	C	D	E	F	G	H	L1	L2	L3				
05ELE53	Faggio	-		-							-	-	-	1	0,4	10,7
	Rovere europeo, Rovere tinto noce, Legno verniciato	-		-							-	-	-			

ogni collo contiene 1 poltroncina

Optionals

Codice	Descrizione	colli	m ³	Kg
02PIE05	Set di piedini in feltro	-	-	-

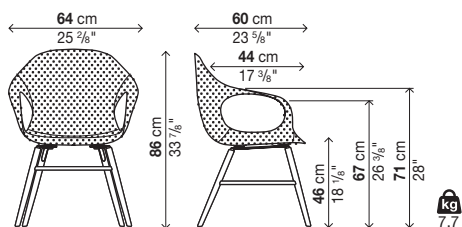

ELEPHANT

Rocking - Scocca in poliuretano

Finitura base:

Legno massello di faggio
 Legno massello di rovere europeo
 Legno massello di rovere tinto noce
 Legno massello verniciato (nei colori del poliuretano)

Finitura scocca:

Poliuretano bianco (P001)
 Poliuretano nero (P003)
 Poliuretano beige (P004)
 Poliuretano terracotta (P006)
 Poliuretano verde oliva (P008)
 Poliuretano rosso rubino (P010)
 Poliuretano grigio Londra (P011)
 Poliuretano blu polvere (P012)

Finitura rivestimento cuscino Elephant:

A = Valencia (pelle sintetica), COM (tessuto Cliente)
 B = Field 2
 C = Clara 2, Merit
 D = Curmi, Patio, Remix 2
 E = Canvas 2, Hero, Melange Nap
 F = Regal, Scuba, Steelcut Trio 3
 G = Divina Melange 3, Hallingdal 65
 H = Twill Weave

Finitura rivestimento cuscino Lips:

A = COM (tessuto Cliente)
 B = Field 2

Note:

Per ordini COM vedi interno di copertina.

Per informazioni su composizioni tessuti vedi interno di copertina.

INFO SPEDIZIONI SMONTATO:

Per ordini superiori alle 8 unità, il prodotto viene spedito smontato (solo per poltroncine con scocca in poliuretano).
 - 4 scocche = 1 collo - Kg 19 / m² 0,41
 - 2 basi = 1 collo - Kg 10 / m³ 0,34

Consumo cuscino Elephant: 0,55 ml (H. 140 cm).

Consumo cuscino Lips: 0,5 ml (H. 140 cm).

Imballi rinforzati vedi interno di copertina.

Codice	Base	Scocca		
		colli	m ²	Kg
		Poliuretano		
05ELE91	Faggio			
	Rovere europeo, Rovere tinto noce, Legno verniciato	1	0,56	12

ogni collo contiene 1 poltroncina

Optionals

Codice	Descrizione	Rivestimento										colli	m ²	Kg	
		A	B	C	D	E	F	G	H	L1	L2				L3
20ELE01	Cuscino rimovibile Elephant (non sfoderabile)									-	-	-	1	0,02	1
20LIR01	Cuscino rimovibile LIPS-R (non sfoderabile)			-	-	-	-	-	-	-	-	-	1	0,01	1
20LIS01	Cuscino rimovibile LIPS-S (non sfoderabile)			-	-	-	-	-	-	-	-	-	1	0,01	1

ELEPHANT (20ELE01)

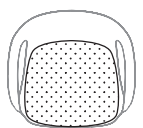

kg
0,6

LIPS-R (20LIR01)

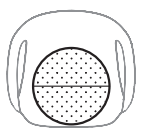

kg
0,6

LIPS-S (20LIS01)

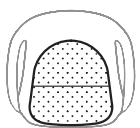

kg
0,6

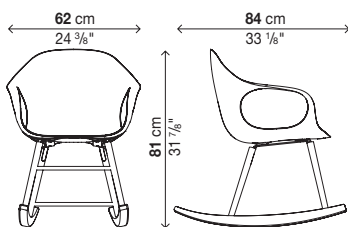

ELEPHANT

Rocking - Scocca rivestita in cuoio (non sfoderabile)

Finitura base:

Legno massello di faggio
Legno massello di rovere europeo
Legno massello di rovere tinto noce
Legno massello verniciato (nei colori del poliuretano)

Finitura rivestimento:

Cuoietto (C)
Cuoio "pieno fiore" (PF) naturale o nero

Note:

Attenzione: le misure o le finiture contrassegnate con (!) hanno tempi di produzione più lunghi, circa 6 settimane dalla data dell'ordine.

Per colori cuciture e bordi vedi "regole cuoio" interno di copertina.

Imballi rinforzati vedi interno di copertina.

Codice	Base	Scocca		colli	m ³	Kg
		Cuoietto (C) (!)	Cuoio "pieno fiore" (PF) (!)			
05ELE92	Faggio			1	0,56	14
	Rovere europeo, Rovere tinto noce, Legno verniciato					

ogni collo contiene 1 poltroncina

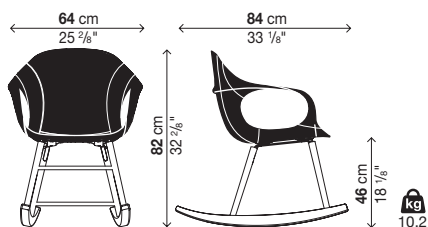

ELEPHANT

Rocking - Scocca rivestita in tessuto (non sfoderabile)

Finitura base:

Legno massello di faggio
 Legno massello di rovere europeo
 Legno massello di rovere tinto noce
 Legno massello verniciato (nei colori del poliuretano)

Finitura rivestimento:

B = COM (tessuto Cliente)
 D = Remix 2
 E = Canvas 2, Hero, Melange Nap
 F = Regal, Steelcut Trio 3
 G = Divina Melange 3, Hallingdal 65
 H = Twill Weave

Note:

Per ordini COM vedi interno di copertina.

Per informazioni su composizioni tessuti vedi interno di copertina.

Consumo COM: 1,5 ml (H. 140 cm).

Imballi rinforzati vedi interno di copertina.

Codice	Base	Rivestimento										colli	m ³	Kg	
		A	B	C	D	E	F	G	H	L1	L2				L3
05ELE93	Faggio	-		-						-	-	-	1	0,56	13,5
	Rovere europeo, Rovere tinto noce, Legno verniciato	-		-						-	-	-			

ogni collo contiene 1 poltroncina

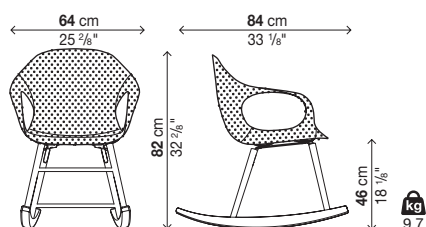

ELEPHANT

Trespolo girevole - Scocca in poliuretano

Finitura base:

Alluminio lucidato

Alluminio verniciato (nei colori del poliuretano)

Finitura scocca:

Poliuretano bianco (P001)

Poliuretano nero (P003)

Poliuretano beige (P004)

Poliuretano terracotta (P006)

Poliuretano verde oliva (P008)

Poliuretano rosso rubino (P010)

Poliuretano grigio Londra (P011)

Poliuretano blu polvere (P012)

Finitura rivestimento cuscino Elephant:

A = Valencia (pelle sintetica), COM (tessuto Cliente)

B = Field 2

C = Clara 2, Merit

D = Curmi, Patio, Remix 2

E = Canvas 2, Hero, Melange Nap

F = Regal, Scuba, Steelcut Trio 3

G = Divina Melange 3, Hallingdal 65

H = Twill Weave

Finitura rivestimento cuscino Lips:

A = COM (tessuto Cliente)

B = Field 2

Note:

Per ordini COM vedi interno di copertina.

Per informazioni su composizioni tessuti vedi interno di copertina.

PIEDINI:

Di serie in feltro per pavimenti in legno.

INFO SPEDIZIONI SMONTATO:

Per ordini superiori alle 8 unità, il prodotto viene spedito smontato (solo per poltroncine con scocca in poliuretano).

- 4 scocche = 1 collo - Kg 19 / m³ 0,41

- 1 basi = 1 collo - Kg 6 / m³ 0,14

Consumo cuscino Elephant: 0,55 ml (H. 140 cm).

Consumo cuscino Lips: 0,5 ml (H. 140 cm).

Imballi rinforzati vedi interno di copertina.

Codice	Base	Scocca	
		colli	m ³ Kg
		Poliuretano	
05ELE72	Alluminio verniciato	1	0,38 11,5
	Alluminio lucidato		

ogni collo contiene 1 poltroncina

Optionals

Codice	Descrizione	Rivestimento											colli	m ³	Kg			
		A	B	C	D	E	F	G	H	L1	L2	L3						
20ELE01	Cuscino rimovibile Elephant (non sfoderabile)												-	-	-	1	0,02	1
20LIR01	Cuscino rimovibile LIPS-R (non sfoderabile)			-	-	-	-	-	-	-	-	-	-	-	-	1	0,01	1
20LIS01	Cuscino rimovibile LIPS-S (non sfoderabile)			-	-	-	-	-	-	-	-	-	-	-	-	1	0,01	1

ELEPHANT (20ELE01)

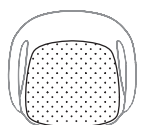

kg
0,6

LIPS-R (20LIR01)

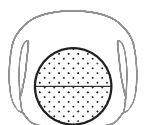

kg
0,6

LIPS-S (20LIS01)



kg
0,6

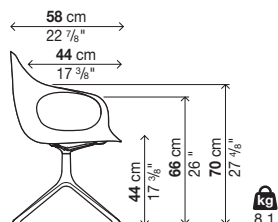
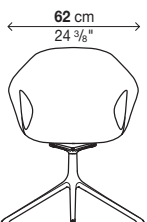
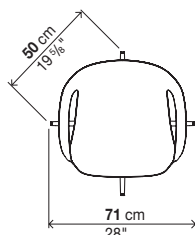

ELEPHANT

Trespolo girevole - Scocca rivestita in cuoio (non sfoderabile)

Finitura base:

Alluminio lucidato

Alluminio verniciato (nei colori del poliuretano)

Finitura rivestimento:

Cuoietto (C)

Cuoio "pieno fiore" (PF) naturale o nero

Note:

Attenzione: le misure o le finiture contrassegnate con (!) hanno tempi di produzione più lunghi, circa 6 settimane dalla data dell'ordine.

Per colori cuciture e bordi vedi "regole cuoio" interno di copertina.

PIEDINI:

Di serie in feltro per pavimenti in legno.

Imballi rinforzati vedi interno di copertina.

Codice	Base	Scocca		colli	m ³	Kg
		Cuoietto (C) (!)	Cuoio "pieno fiore" (PF) (!)			
05ELE71	Alluminio verniciato			1	0,38	14
	Alluminio lucidato					

ogni collo contiene 1 poltroncina

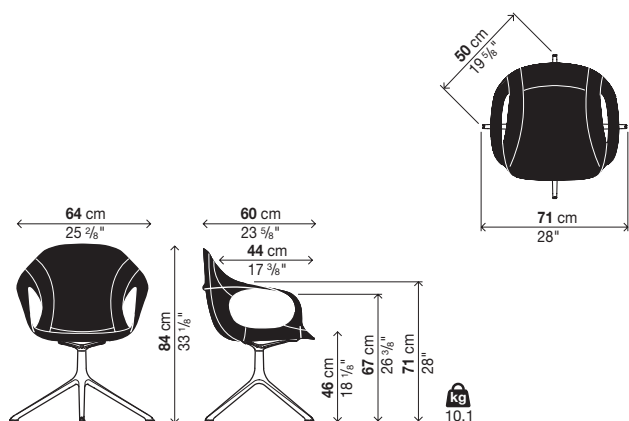

ELEPHANT

Trespolo girevole - Scocca rivestita in tessuto (non sfoderabile)

Finitura base:

Alluminio lucidato

Alluminio verniciato (nei colori del poliuretano)

Finitura rivestimento:

B = COM (tessuto Cliente)

D = Remix 2

E = Canvas 2, Hero, Melange Nap

F = Regal, Steelcut Trio 3

G = Divina Melange 3, Hallingdal 65

H = Twill Weave

Note:

Per ordini COM vedi interno di copertina.

Per informazioni su composizioni tessuti vedi interno di copertina.

PIEDINI:

Di serie in feltro per pavimenti in legno.

Consumo COM: 1,5 ml (H. 140 cm).

Imballi rinforzati vedi interno di copertina.

Codice	Base	Rivestimento											colli	m ²	Kg	
		A	B	C	D	E	F	G	H	L1	L2	L3				
05ELE54	Alluminio verniciato	-		-							-	-	-	1	0,38	13,5
	Alluminio lucidato	-		-							-	-	-			

ogni collo contiene 1 poltroncina

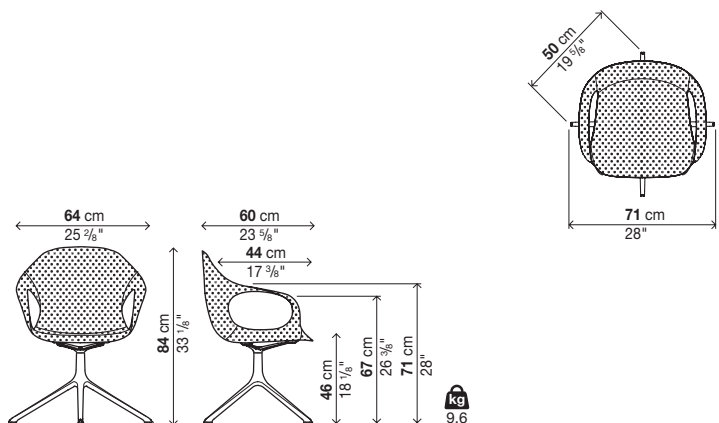

ELEPHANT

Cinque razze con ruote - Scocca in poliuretano

Finitura base:

Alluminio lucidato
Alluminio verniciato (bianco, nero)

Finitura scocca:

Poliuretano bianco (P001)
Poliuretano nero (P003)
Poliuretano beige (P004)
Poliuretano terracotta (P006)
Poliuretano verde oliva (P008)
Poliuretano rosso rubino (P010)
Poliuretano grigio Londra (P011)
Poliuretano blu polvere (P012)

Finitura rivestimento cuscino Elephant:

A = Valencia (pelle sintetica), COM (tessuto Cliente)
B = Field 2
C = Clara 2, Merit
D = Curmi, Patio, Remix 2
E = Canvas 2, Hero, Melange Nap
F = Regal, Scuba, Steelcut Trio 3
G = Divina Melange 3, Hallingdal 65
H = Twill Weave

Finitura rivestimento cuscino Lips:

A = COM (tessuto Cliente)
B = Field 2

Note:

Per ordini COM vedi interno di copertina.

Per informazioni su composizioni tessuti vedi interno di copertina.

Ruote piroettanti del tipo auto frenanti con battistrada morbido.

INFO SPEDIZIONI SMONTATO:

Per ordini superiori alle 8 unità, il prodotto viene spedito smontato (solo per poltroncine con scocca in poliuretano).

- 4 scocche = 1 collo - Kg 19 / m³ 0,41
- 1 basi = 1 collo - Kg 15 / m³ 0,14

Consumo cuscino Elephant: 0,55 ml (H. 140 cm).

Consumo cuscino Lips: 0,5 ml (H. 140 cm).

Imballi rinforzati vedi interno di copertina.

Codice	Base	Scocca		
		colli	m ³	Kg
		Poliuretano		
05ELE41	Alluminio verniciato	1	0,38	13
	Alluminio lucidato			

ogni collo contiene 1 poltroncina

Optionals

Codice	Descrizione	Rivestimento											colli	m ³	Kg	
		A	B	C	D	E	F	G	H	L1	L2	L3				
20ELE01	Cuscino rimovibile Elephant (non sfoderabile)										-	-	-	1	0,02	1
20LIR01	Cuscino rimovibile LIPS-R (non sfoderabile)			-	-	-	-	-	-	-	-	-	-	1	0,01	1
20LIS01	Cuscino rimovibile LIPS-S (non sfoderabile)			-	-	-	-	-	-	-	-	-	-	1	0,01	1

ELEPHANT (20ELE01)



kg
0,6

LIPS-R (20LIR01)

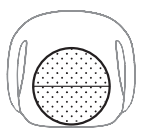

kg
0,6

LIPS-S (20LIS01)

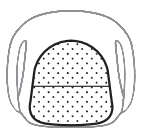

kg
0,6

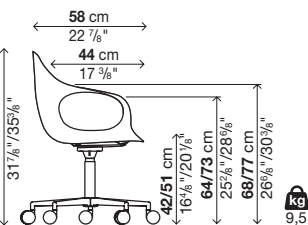
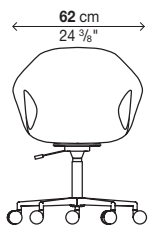
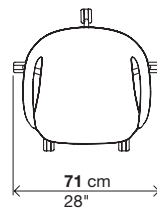

ELEPHANT

Cinque razze con ruote - Scocca rivestita in cuoio (non sfoderabile)

Finitura base:

Alluminio lucidato

Alluminio verniciato (bianco, nero)

Finitura rivestimento:

Cuoietto (C)

Cuoio "pieno fiore" (PF) naturale o nero

Note:

Attenzione: le misure o le finiture contrassegnate con (!) hanno tempi di produzione più lunghi, circa 6 settimane dalla data dell'ordine.

Per colori cuciture e bordi vedi "regole cuoio" interno di copertina.

Ruote piroettanti del tipo auto frenanti con battistrada morbido.

Imballi rinforzati vedi interno di copertina.

Codice	Base	Scocca		colli	m ³	Kg
		Cuoietto (C) (!)	Cuoio "pieno fiore" (PF) (!)			
05ELE42	Alluminio verniciato			1	0,38	15,5
	Alluminio lucidato					

ogni collo contiene 1 poltroncina

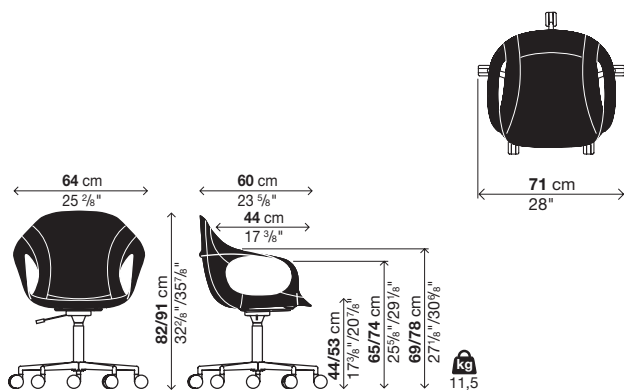

ELEPHANT

Cinque razze con ruote - Scocca rivestita in tessuto (non sfoderabile)

Finitura base:

Alluminio lucidato

Alluminio verniciato (bianco, nero)

Finitura rivestimento:

B = COM (tessuto Cliente)

D = Remix 2

E = Canvas 2, Hero, Melange Nap

F = Regal, Steelcut Trio 3

G = Divina Melange 3, Hallingdal 65

H = Twill Weave

Note:

Per ordini COM vedi interno di copertina.

Per informazioni su composizioni tessuti vedi interno di copertina.

Ruote piroettanti del tipo auto frenanti con battistrada morbido.

Consumo COM: 1,5 ml (H. 140 cm).

Imballi rinforzati vedi interno di copertina.

Codice	Base	Rivestimento											colli	m ²	Kg	
		A	B	C	D	E	F	G	H	L1	L2	L3				
05ELE43	Alluminio verniciato	-		-							-	-	-	1	0,38	15
	Alluminio lucidato	-		-							-	-	-			

ogni collo contiene 1 poltroncina

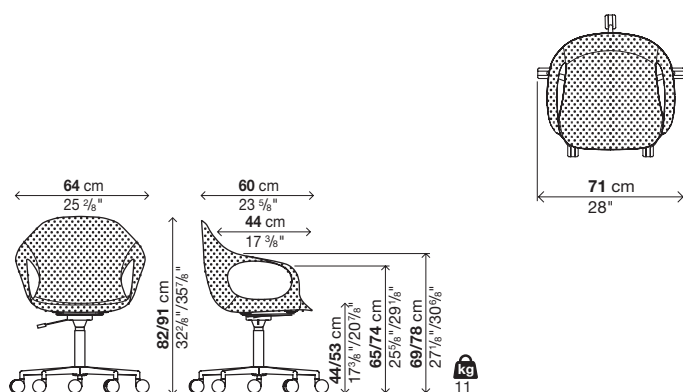

ELEPHANT

Poltroncina lounge - Scocca in poliuretano

Finitura base:

Acciaio cromato
 Acciaio cromato nero
 Acciaio effetto ottone
 Acciaio verniciato (nei colori del poliuretano)

Finitura scocca:

Poliuretano bianco (P001)
 Poliuretano nero (P003)
 Poliuretano beige (P004)
 Poliuretano terracotta (P006)
 Poliuretano verde oliva (P008)
 Poliuretano rosso rubino (P010)
 Poliuretano grigio Londra (P011)
 Poliuretano blu polvere (P012)

Finitura rivestimento cuscino Elephant:

A = Valencia (pelle sintetica), COM (tessuto Cliente)
 B = Field 2
 C = Clara 2, Merit
 D = Curmi, Patio, Remix 2
 E = Canvas 2, Hero, Melange Nap
 F = Regal, Scuba, Steelcut Trio 3
 G = Divina Melange 3, Hallingdal 65
 H = Twill Weave

Finitura rivestimento cuscino Lips:

A = COM (tessuto Cliente)
 B = Field 2

Note:

Per ordini COM vedi interno di copertina.

Per informazioni su composizioni tessuti vedi interno di copertina.

PIEDINI:

Di serie in plastica dura. Su richiesta vengono forniti piedini con inserto in feltro per pavimenti in legno.

INFO SPEDIZIONI SMONTATO:

Per ordini superiori alle 8 unità, il prodotto viene spedito smontato (solo per poltroncine con scocca in poliuretano).

- 4 scocche = 1 collo - Kg 19 / m³ 0,41

- 4 basi = 1 collo - Kg 14 / m³ 0,28

Consumo cuscino Elephant: 0,55 ml (H. 140 cm).

Consumo cuscino Lips: 0,5 ml (H. 140 cm).

Imballi rinforzati vedi interno di copertina.

Codice	Base	Scocca		
		colli	m ³	Kg
		Poliuretano		
05ELE03	Acciaio verniciato, Acciaio cromato, Acciaio cromato nero	1	0,4	10
	Acciaio effetto ottone			

ogni collo contiene 1 poltroncina

Optionals

Codice	Descrizione	Rivestimento											colli	m ²	Kg	
		A	B	C	D	E	F	G	H	L1	L2	L3				
20ELE01	Cuscino rimovibile Elephant (non sfoderabile)										-	-	-	1	0,02	1
20LIR01	Cuscino rimovibile LIPS-R (non sfoderabile)			-	-	-	-	-	-	-	-	-	-	1	0,01	1
20LIS01	Cuscino rimovibile LIPS-S (non sfoderabile)			-	-	-	-	-	-	-	-	-	-	1	0,01	1
02PIE14	Set di piedini in feltro													-	-	-

ELEPHANT (20ELE01)

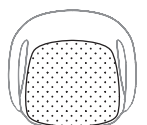

kg
0,6

LIPS-R (20LIR01)

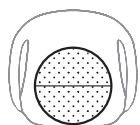

kg
0,6

LIPS-S (20LIS01)

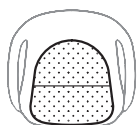

kg
0,6

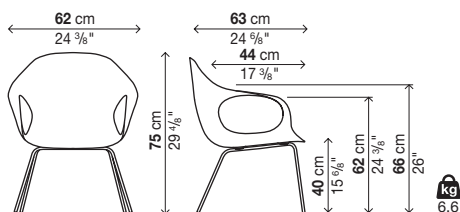

ELEPHANT

Poltroncina lounge - Scocca rivestita in cuoio (non sfoderabile)

Finitura base:

Acciaio cromato
 Acciaio cromato nero
 Acciaio effetto ottone
 Acciaio verniciato (nei colori del poliuretano)

Finitura rivestimento:

Cuoietto (C)
 Cuoio "pieno fiore" (PF) naturale o nero

Note:

Attenzione: le misure o le finiture contrassegnate con (!) hanno tempi di produzione più lunghi, circa 6 settimane dalla data dell'ordine.

Per colori cuciture e bordi vedi "regole cuoio" interno di copertina.

Imballi rinforzati vedi interno di copertina.

Codice	Base	Scocca		colli	m ²	Kg
		Cuoietto (C) (!)	Cuoio "pieno fiore" (PF) (!)			
05ELE13	Acciaio verniciato, Acciaio cromato, Acciaio cromato nero			1	0,4	11,5
	Acciaio effetto ottone					

ogni collo contiene 1 poltroncina

Optionals

Codice	Descrizione	colli	m ²	Kg
02PIE14	Set di piedini in feltro	-	-	-

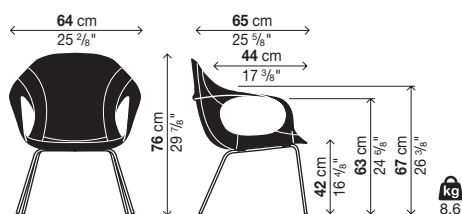

ELEPHANT

Poltroncina lounge - Scocca rivestita in tessuto (non sfoderabile)

Finitura base:

Acciaio cromato
 Acciaio cromato nero
 Acciaio effetto ottone
 Acciaio verniciato (nei colori del poliuretano)

Finitura rivestimento:

B = COM (tessuto Cliente)
 D = Remix 2
 E = Canvas 2, Hero, Melange Nap
 F = Regal, Steelcut Trio 3
 G = Divina Melange 3, Hallingdal 65
 H = Twill Weave

Note:

Per ordini COM vedi interno di copertina.

Per informazioni su composizioni tessuti vedi interno di copertina.

PIEDINI:

Di serie in plastica dura. Su richiesta vengono forniti piedini con inserto in feltro per pavimenti in legno.

Consumo COM: 1,5 ml (H. 140 cm).

Imballi rinforzati vedi interno di copertina.

Codice	Base	Rivestimento										colli	m ³	Kg		
		A	B	C	D	E	F	G	H	L1	L2				L3	
05ELE23	Acciaio verniciato, Acciaio cromato, Acciaio cromato nero	-		-							-	-	-	1	0,4	11
	Acciaio effetto ottone	-		-							-	-	-			

ogni collo contiene 1 poltroncina

Optionals

Codice	Descrizione	colli	m ³	Kg
02PIE14	Set di piedini in feltro	-	-	-

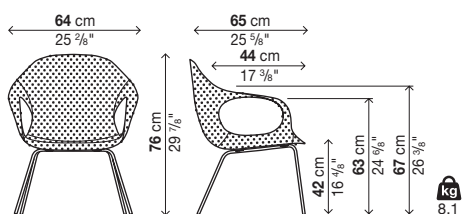

ELEPHANT

Übersicht

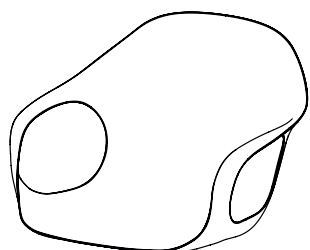
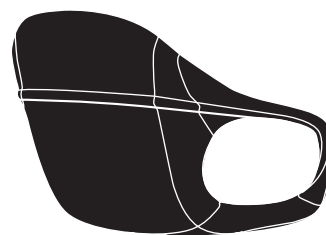

Aufbau aus Polyurethan

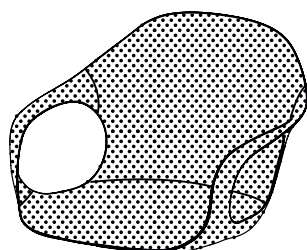

Aufbau mit Stoffbezug

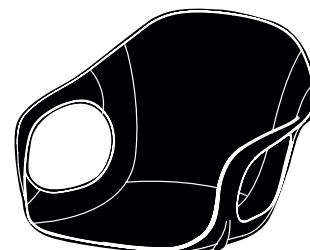

Aufbau mit Lederbezug



Vier Beine

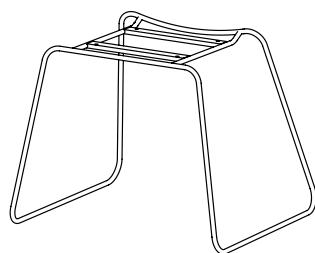

Kufengestell

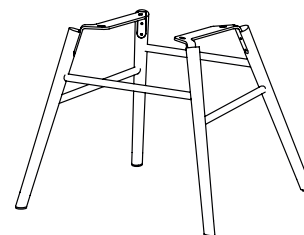

Untergestell aus Holz

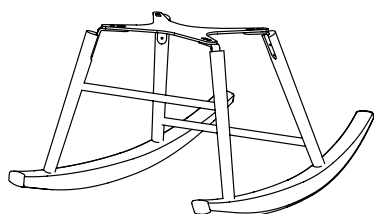

Rocking

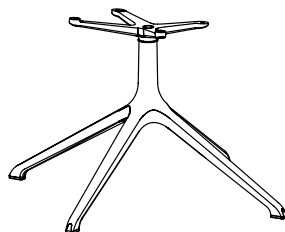

Ständer

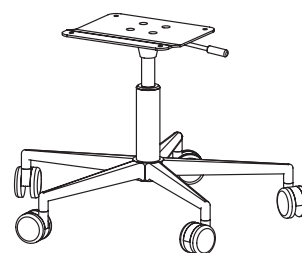

Fünf Ausleger mit Rollen

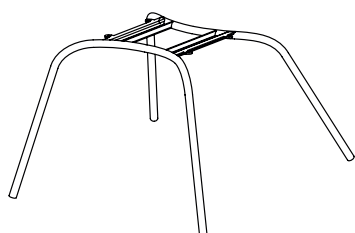

Lounge

ELEPHANT

Vier Beine - Aufbau aus Polyurethan

Ausführung Gestell:

Verchromter Stahl
Schwarz verchromter Stahl
Satinierter Stahl
Stahl mit Messingeffekt
Lackierter Stahl (in den Polyurethan-Farben)

Ausführung Aufbau:

Polyurethan Weiß (P001)
Polyurethan Schwarz (P003)
Polyurethan Beige (P004)
Polyurethan Terracotta (P006)
Polyurethan Olivgrün (P008)
Polyurethan Rubinrot (P010)
Polyurethan Grau London (P011)
Polyurethan Wolkenblau (P012)

Ausführung Kissen Elephant:

A = Valencia (Synthetische Leder), COM (Kundenstoff)
B = Field 2
C = Clara 2, Merit
D = Curmi, Patio, Remix 2
E = Canvas 2, Hero, Melange Nap
F = Regal, Scuba, Steelcut Trio 3
G = Divina Melange 3, Hallingdal 65
H = Twill Weave

Ausführung Kissen Lips:

A = COM (Kundenstoff)
B = Field 2

Anmerkung:

Für Bestellungen COM siehe Innenseite des Umschlags.

Für Informationen zur Zusammensetzung der Stoffe siehe Innenseite des Umschlags.

FÜßE:

Standard in Hartplastik. Auf Wunsch liefern wir Füße mit Filzeinlage für Holzböden.

VERSANDINFO DEMONTIERT:

Bei Bestellungen mit mehr als 8 Produkte, werden diese zerlegt geliefert - Sitz und Untergestell getrennt.
(nur bei der Version mit Polyurethansitz gueltig).
- 4 aufbau = 1 kolli - Kg 19 / m³ 0,41.
- 4 untergestell = 1 kolli - Kg 14 / m³ 0,26.

Verbrauch Kissen Elephant: 0,55 ml (H. 140 cm).

Verbrauch Kissen Lips: 0,5 ml (H. 140 cm).

Für verstärkte Verpackungen siehe Innenseite des Umschlags.

Art.-Nr.	Gestell	Aufbau	kolli	m ³	Kg
		Polyurethan			
05ELE11	Lackierter Stahl, Verchromter Stahl, Schwarz verchromter Stahl		1	0,4	10
	Stahl mit Messingeffekt, Satinierter Stahl				

Ein Sessel pro Frachtstück

Optionen

Art.-Nr.	Beschreibung	Bezug											kolli	m ³	Kg	
		A	B	C	D	E	F	G	H	L1	L2	L3				
20ELE01	Abnehmbares Kissen Elephant (nicht abziehbar)										-	-	-	1	0,02	1
20LIR01	Abnehmbares Kissen LIPS-R (nicht abziehbar)			-	-	-	-	-	-	-	-	-	-	1	0,01	1
20LIS01	Abnehmbares Kissen LIPS-S (nicht abziehbar)			-	-	-	-	-	-	-	-	-	-	1	0,01	1
02PIE03	Set Filzfüße													-	-	-

ELEPHANT (20ELE01)

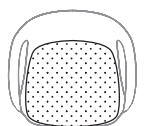

kg
0,6

LIPS-R (20LIR01)

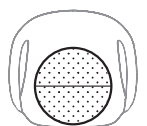

kg
0,6

LIPS-S (20LIS01)



kg
0,6

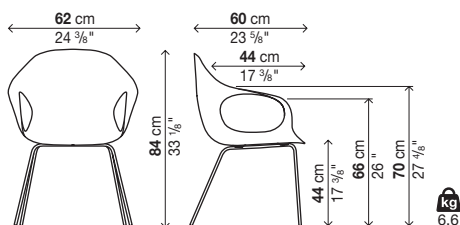

ELEPHANT

Vier Beine - Aufbau mit Lederbezug (nicht abziehbar)

Ausführung Gestell:

Verchromter Stahl
 Schwarz verchromter Stahl
 Satinierter Stahl
 Stahl mit Messingeffekt
 Lackierter Stahl (in den Polyurethan-Farben)

Ausführung des Bezugs:

Cuoietto Kernleder (C)
 "Vollnarbiges" Kernleder (PF) Natur oder schwarz

Anmerkung:

Achtung: Die mit (!) gekennzeichneten Maße oder Ausführungen haben eine längere Produktionszeit: zirka 6 Wochen ab Auftragsdatum.

Bez. Nahtfarbe und Kanten siehe "Regeln Kernleder" Innenseite des Umschlags.

FÜßE:

Standard in Hartplastik. Auf Wunsch liefern wir Füße mit Filzeinlage für Holzböden.

Für verstärkte Verpackungen siehe Innenseite des Umschlags.

Art.-Nr.	Gestell	Bezug		kolli	m ²	Kg
		"Cuoietto" Kernleder (!)	"Vollnarbiges" Kernleder (PF) (!)			
05ELE01	Lackierter Stahl, Verchromter Stahl, Schwarz verchromter Stahl			1	0,4	11,5
	Stahl mit Messingeffekt, Satinierter Stahl					

Ein Sessel pro Frachtstück

Optionen

Art.-Nr.	Beschreibung	kolli	m ²	Kg
02PIE03	Set Filzfüße	-	-	-

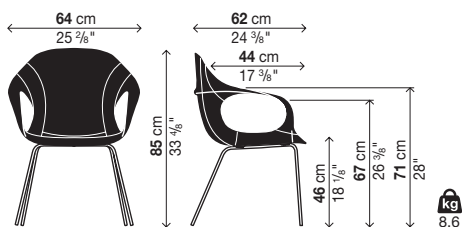

ELEPHANT

Vier Beine - Aufbau mit Stoffbezug (nicht abziehbar)

Ausführung Gestell:

Verchromter Stahl
 Schwarz verchromter Stahl
 Satinierter Stahl
 Stahl mit Messingeffekt
 Lackierter Stahl (in den Polyurethan-Farben)

Ausführung des Bezugs:

B = COM (Kundenstoff)
 D = Remix 2
 E = Canvas 2, Hero, Melange Nap
 F = Regal, Steelcut Trio 3
 G = Divina Melange 3, Hallingdal 65
 H = Twill Weave

Anmerkung:

Für Bestellungen COM siehe Innenseite des Umschlags.

Für Informationen zur Zusammensetzung der Stoffe siehe Innenseite des Umschlags.

FÜßE:

Standard in Hartplastik. Auf Wunsch liefern wir Füße mit Filzeinlage für Holzböden.

Verbrauch COM: 1,5 ml (H. 140 cm).

Für verstärkte Verpackungen siehe Innenseite des Umschlags.

Art.-Nr.	Gestell	Bezug											kolli	m ²	Kg	
		A	B	C	D	E	F	G	H	L1	L2	L3				
05ELE51	Lackierter Stahl, Verchromter Stahl, Schwarz verchromter Stahl	-		-							-	-	-	1	0,4	11
	Stahl mit Messingeffekt, Satinierter Stahl	-		-							-	-	-			

Ein Sessel pro Frachtstück

Optionen

Art.-Nr.	Beschreibung	kolli	m ²	Kg
02PIE03	Set Filzfüße	-	-	-

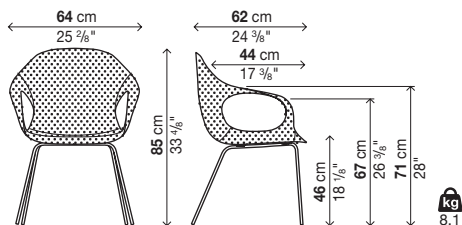

ELEPHANT

Kufengestell - Aufbau aus Polyurethan

Ausführung Gestell:

Verchromter Stahl
Schwarz verchromter Stahl
Satinierter Stahl
Stahl mit Messingeffekt
Lackierter Stahl (in den Polyurethan-Farben)

Ausführung Aufbau:

Polyurethan Weiß (P001)
Polyurethan Schwarz (P003)
Polyurethan Beige (P004)
Polyurethan Terracotta (P006)
Polyurethan Olivgrün (P008)
Polyurethan Rubinrot (P010)
Polyurethan Grau London (P011)
Polyurethan Wolkenblau (P012)

Ausführung Kissen Elephant:

A = Valencia (Synthetische Leder), COM (Kundenstoff)
B = Field 2
C = Clara 2, Merit
D = Curmi, Patio, Remix 2
E = Canvas 2, Hero, Melange Nap
F = Regal, Scuba, Steelcut Trio 3
G = Divina Melange 3, Hallingdal 65
H = Twill Weave

Ausführung Kissen Lips:

A = COM (Kundenstoff)
B = Field 2

Anmerkung:

Für Bestellungen COM siehe Innenseite des Umschlags.

Für Informationen zur Zusammensetzung der Stoffe siehe Innenseite des Umschlags.

FÜßE:

Standard in Hartplastik. Auf Wunsch liefern wir Füße mit Filzeinlage für Holzböden.

VERSANDINFO DEMONTIERT:

Bei Bestellungen mit mehr als 8 Produkte, werden diese zerlegt geliefert - Sitz und Untergestell getrennt. (nur bei der Version mit Polyurethansitz gueltig).
- 4 aufbau = 1 kolli - Kg 19 / m³ 0,41
- 4 untergestell = 1 kolli - Kg 19 / m³ 0,26

Verbrauch Kissen Elephant: 0,55 ml (H. 140 cm).

Verbrauch Kissen Lips: 0,5 ml (H. 140 cm).

Für verstärkte Verpackungen siehe Innenseite des Umschlags.

Art.-Nr.	Gestell	Aufbau	kolli	m ³	Kg
		Polyurethan			
05ELE12	Lackierter Stahl, Verchromter Stahl, Schwarz verchromter Stahl		1	0,4	11,2
	Stahl mit Messingeffekt, Satinierter Stahl				

Ein Sessel pro Frachtstück

Optionen

Art.-Nr.	Beschreibung	Bezug										kolli	m ³	Kg		
		A	B	C	D	E	F	G	H	L1	L2				L3	
20ELE01	Abnehmbares Kissen Elephant (nicht abziehbar)										-	-	-	1	0,02	1
20LIR01	Abnehmbares Kissen LIPS-R (nicht abziehbar)			-	-	-	-	-	-	-	-	-	-	1	0,01	1
20LIS01	Abnehmbares Kissen LIPS-S (nicht abziehbar)			-	-	-	-	-	-	-	-	-	-	1	0,01	1
02PIE03	Set Filzfüße													-	-	-

ELEPHANT (20ELE01)



LIPS-R (20LIR01)

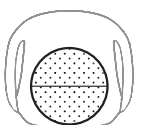

LIPS-S (20LIS01)

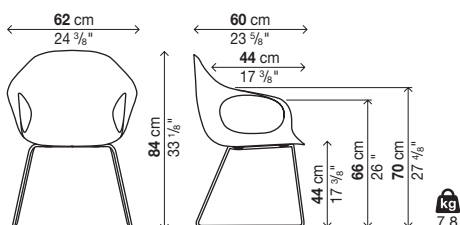

ELEPHANT

Kufengestell - Aufbau mit Lederbezug (nicht abziehbar)

Ausführung Gestell:

Verchromter Stahl
 Schwarz verchromter Stahl
 Satinierter Stahl
 Stahl mit Messingeffekt
 Lackierter Stahl (in den Polyurethan-Farben)

Ausführung des Bezugs:

Cuoietto Kernleder (C)
 "Vollnarbiges" Kernleder (PF) Natur oder schwarz

Anmerkung:

Achtung: Die mit (!) gekennzeichneten Maße oder Ausführungen haben eine längere Produktionszeit: zirka 6 Wochen ab Auftragsdatum.

Bez. Nahtfarbe und Kanten siehe "Regeln Kernleder" Innenseite des Umschlags.

FÜßE:

Standard in Hartplastik. Auf Wunsch liefern wir Füße mit Filzeinlage für Holzböden.

Für verstärkte Verpackungen siehe Innenseite des Umschlags.

Art.-Nr.	Gestell	Bezug		kolli	m ²	Kg
		"Cuoietto" Kernleder (!)	"Vollnarbiges" Kernleder (PF) (!)			
05ELE02	Lackierter Stahl, Verchromter Stahl, Schwarz verchromter Stahl			1	0,4	13
	Stahl mit Messingeffekt, Satinierter Stahl					

Ein Sessel pro Frachtstück

Optionen

Art.-Nr.	Beschreibung	kolli	m ²	Kg
02PIE03	Set Filzfüße	-	-	-

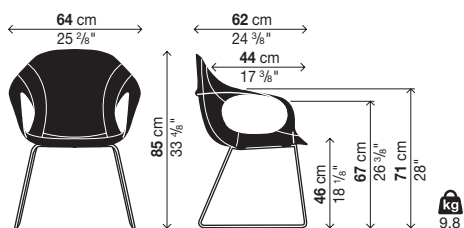

ELEPHANT

Kufengestell - Aufbau mit Stoffbezug (nicht abziehbar)

Ausführung Gestell:

Verchromter Stahl
 Schwarz verchromter Stahl
 Satinierter Stahl
 Stahl mit Messingeffekt
 Lackierter Stahl (in den Polyurethan-Farben)

Ausführung des Bezugs:

B = COM (Kundenstoff)
 D = Remix 2
 E = Canvas 2, Hero, Melange Nap
 F = Regal, Steelcut Trio 3
 G = Divina Melange 3, Hallingdal 65
 H = Twill Weave

Anmerkung:

Für Bestellungen COM siehe Innenseite des Umschlags.

Für Informationen zur Zusammensetzung der Stoffe siehe Innenseite des Umschlags.

FÜßE:

Standard in Hartplastik. Auf Wunsch liefern wir Füße mit Filzeinlage für Holzböden.

Verbrauch COM: 1,5 ml (H. 140 cm).

Für verstärkte Verpackungen siehe Innenseite des Umschlags.

Art.-Nr.	Gestell	Bezug										kolli	m ²	Kg		
		A	B	C	D	E	F	G	H	L1	L2				L3	
05ELE52	Lackierter Stahl, Verchromter Stahl, Schwarz verchromter Stahl	-		-							-	-	-	1	0,4	12,5
	Stahl mit Messingeffekt, Satinierter Stahl	-		-							-	-	-			

Ein Sessel pro Frachtstück

Optionen

Art.-Nr.	Beschreibung	kolli	m ²	Kg
02PIE04	Set Filzfüße	-	-	-

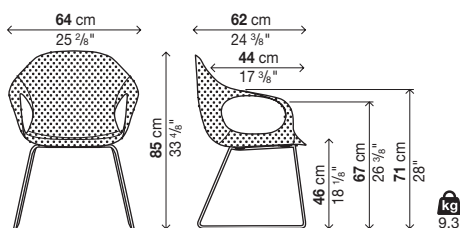

ELEPHANT

Untergestell aus Holz - Aufbau aus Polyurethan

Ausführung Gestell:

Massives Buchenholz
 Massives europäisches Eichenholz
 Massives Eichenholz Farbe Nussbaum
 Massivholz lackiert (in den Polyurethan-Farben)

Ausführung Aufbau:

Polyurethan Weiß (P001)
 Polyurethan Schwarz (P003)
 Polyurethan Beige (P004)
 Polyurethan Terracotta (P006)
 Polyurethan Olivgrün (P008)
 Polyurethan Rubinrot (P010)
 Polyurethan Grau London (P011)
 Polyurethan Wolkenblau (P012)

Ausführung Kissen Elephant:

A = Valencia (Synthetische Leder), COM (Kundenstoff)
 B = Field 2
 C = Clara 2, Merit
 D = Curmi, Patio, Remix 2
 E = Canvas 2, Hero, Melange Nap
 F = Regal, Scuba, Steelcut Trio 3
 G = Divina Melange 3, Hallingdal 65
 H = Twill Weave

Ausführung Kissen Lips:

A = COM (Kundenstoff)
 B = Field 2

Anmerkung:

Für Bestellungen COM siehe Innenseite des Umschlags.

Für Informationen zur Zusammensetzung der Stoffe siehe Innenseite des Umschlags.

FÜßE:

Standard in Hartplastik. Auf Wunsch liefern wir Füße mit Filzeinlage für Holzböden.

VERSANDINFO DEMONTIERT:

Bei Bestellungen mit mehr als 8 Produkte, werden diese zerlegt geliefert - Sitz und Untergestell getrennt. (nur bei der Version mit Polyurethansitz gueltig).
 - 4 aufbau = 1 kolli - Kg 19 / m³ 0,41
 - 4 untergestell = 1 kolli - Kg 12 / m³ 0,33

Verbrauch Kissen Elephant: 0,55 ml (H. 140 cm).

Verbrauch Kissen Lips: 0,5 ml (H. 140 cm).

Für verstärkte Verpackungen siehe Innenseite des Umschlags.

Art.-Nr.	Gestell	Aufbau		
		Polyurethan		
05ELE82	Buchenholz			
	Europäische Eiche, Farbe Nussbaum, Lackiertes Holz			
				1 0,4 9,3

Ein Sessel pro Frachtstück

Optionen

Art.-Nr.	Beschreibung	Bezug											kolli	m ³	Kg	
		A	B	C	D	E	F	G	H	L1	L2	L3				
20ELE01	Abnehmbares Kissen Elephant (nicht abziehbar)										-	-	-	1	0,02	1
20LIR01	Abnehmbares Kissen LIPS-R (nicht abziehbar)			-	-	-	-	-	-	-	-	-	-	1	0,01	1
20LIS01	Abnehmbares Kissen LIPS-S (nicht abziehbar)			-	-	-	-	-	-	-	-	-	-	1	0,01	1
02PIE05	Set Filzfüße															

ELEPHANT (20ELE01)

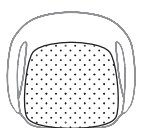

kg
0,6

LIPS-R (20LIR01)

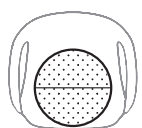

kg
0,6

LIPS-S (20LIS01)

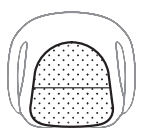

kg
0,6

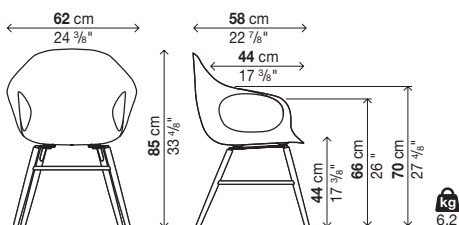

ELEPHANT

Untergestell aus Holz - Aufbau mit Lederbezug (nicht abziehbar)

Ausführung Gestell:

Massives Buchenholz
 Massives europäisches Eichenholz
 Massives Eichenholz Farbe Nussbaum
 Massivholz lackiert (in den Polyurethan-Farben)

Ausführung des Bezugs:

Cuoietto Kernleder (C)
 "Vollnarbiges" Kernleder (PF) Natur oder schwarz

Anmerkung:

Achtung: Die mit (!) gekennzeichneten Maße oder Ausführungen haben eine längere Produktionszeit: zirka 6 Wochen ab Auftragsdatum.

Bez. Nahtfarbe und Kanten siehe "Regeln Kernleder" Innenseite des Umschlags.

FÜßE:

Standard in Hartplastik. Auf Wunsch liefern wir Füße mit Filzeinlage für Holzböden.

Für verstärkte Verpackungen siehe Innenseite des Umschlags.

Art.-Nr.	Gestell	Bezug		kolli	m ²	Kg
		"Cuoietto" Kernleder (!)	"Vollnarbiges" Kernleder (PF) (!)			
05ELE81	Buchenholz			1	0,38	11,2
	Europäische Eiche, Farbe Nussbaum, Lackiertes Holz					

Ein Sessel pro Frachtstück

Optionen

Art.-Nr.	Beschreibung	kolli	m ³	Kg
02PIE05	Set Filzfüße	-	-	-

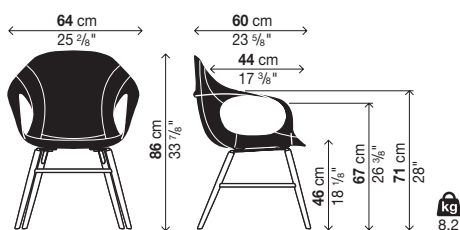

ELEPHANT

Untergestell aus Holz - Aufbau mit Stoffbezug (nicht abziehbar)

Ausführung Gestell:

Massives Buchenholz
 Massives europäisches Eichenholz
 Massives Eichenholz Farbe Nussbaum
 Massivholz lackiert (in den Polyurethan-Farben)

Ausführung des Bezugs:

B = COM (Kundenstoff)
 D = Remix 2
 E = Canvas 2, Hero, Melange Nap
 F = Regal, Steelcut Trio 3
 G = Divina Melange 3, Hallingdal 65
 H = Twill Weave

Anmerkung:

Für Bestellungen COM siehe Innenseite des Umschlags.

Für Informationen zur Zusammensetzung der Stoffe siehe Innenseite des Umschlags.

FÜßE:

Standard in Hartplastik. Auf Wunsch liefern wir Füße mit Filzeinlage für Holzböden.

Verbrauch COM: 1,5 ml (H. 140 cm).

Für verstärkte Verpackungen siehe Innenseite des Umschlags.

Art.-Nr.	Gestell	Bezug											kolli	m³	Kg	
		A	B	C	D	E	F	G	H	L1	L2	L3				
05ELE53	Buchenholz	-		-							-	-	-	1	0,4	10,7
	Europäische Eiche, Farbe Nussbaum, Lackiertes Holz	-		-							-	-	-			

Ein Sessel pro Frachtstück

Optionen

Art.-Nr.	Beschreibung	kolli	m³	Kg
02PIE05	Set Filzfüße	-	-	-

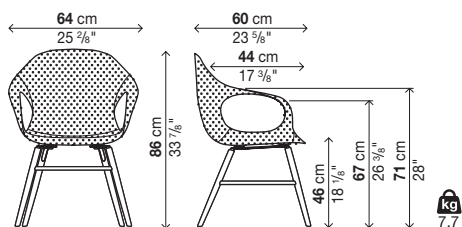

ELEPHANT

Rocking - Aufbau aus Polyurethan

Ausführung Gestell:

Massives Buchenholz
 Massives europäisches Eichenholz
 Massives Eichenholz Farbe Nussbaum
 Massivholz lackiert (in den Polyurethan-Farben)

Ausführung Aufbau:

Polyurethan Weiß (P001)
 Polyurethan Schwarz (P003)
 Polyurethan Beige (P004)
 Polyurethan Terracotta (P006)
 Polyurethan Olivgrün (P008)
 Polyurethan Rubinrot (P010)
 Polyurethan Grau London (P011)
 Polyurethan Wolkenblau (P012)

Ausführung Kissen Elephant:

A = Valencia (Synthetische Leder), COM (Kundenstoff)
 B = Field 2
 C = Clara 2, Merit
 D = Curmi, Patio, Remix 2
 E = Canvas 2, Hero, Melange Nap
 F = Regal, Scuba, Steelcut Trio 3
 G = Divina Melange 3, Hallingdal 65
 H = Twill Weave

Ausführung Kissen Lips:

A = COM (Kundenstoff)
 B = Field 2

Anmerkung:

Für Bestellungen COM siehe Innenseite des Umschlags.

Für Informationen zur Zusammensetzung der Stoffe siehe Innenseite des Umschlags.

VERSANDINFO DEMONTIERT:

Bei Bestellungen mit mehr als 8 Produkte, werden diese zerlegt geliefert - Sitz und Untergestell getrennt.
 (nur bei der Version mit Polyurethansitz gueltig).
 - 4 aufbau = 1 kolli - Kg 19 / m³ 0,41
 - 2 untergestell = 1 kolli - Kg 10 / m³ 0,34

Verbrauch Kissen Elephant: 0,55 ml (H. 140 cm).

Verbrauch Kissen Lips: 0,5 ml (H. 140 cm).

Für verstärkte Verpackungen siehe Innenseite des Umschlags.

Art.-Nr.	Gestell	Aufbau			
		Polyurethan			
05ELE91	Buchenholz				1 0,56 12
	Europäische Eiche, Farbe Nussbaum, Lackiertes Holz				

Ein Sessel pro Frachtstück

Optionen

Art.-Nr.	Beschreibung	Bezug										kolli	m ²	Kg	
		A	B	C	D	E	F	G	H	L1	L2				L3
20ELE01	Abnehmbares Kissen Elephant (nicht abziehbar)									-	-	-	1	0,02	1
20LIR01	Abnehmbares Kissen LIPS-R (nicht abziehbar)			-	-	-	-	-	-	-	-	-	1	0,01	1
20LIS01	Abnehmbares Kissen LIPS-S (nicht abziehbar)			-	-	-	-	-	-	-	-	-	1	0,01	1

ELEPHANT (20ELE01)

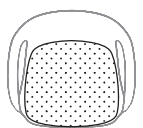

kg
0,6

LIPS-R (20LIR01)

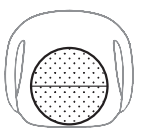

kg
0,6

LIPS-S (20LIS01)



kg
0,6

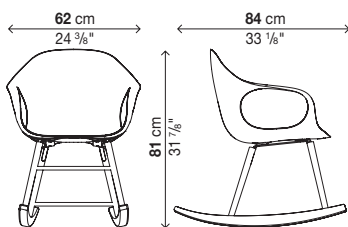

ELEPHANT

Rocking - Aufbau mit Lederbezug (nicht abziehbar)

Ausführung Gestell:

Massives Buchenholz
 Massives europäisches Eichenholz
 Massives Eichenholz Farbe Nussbaum
 Massivholz lackiert (in den Polyurethan-Farben)

Ausführung des Bezugs:

Cuoietto Kernleder (C)
 "Vollnarbiges" Kernleder (PF) Natur oder schwarz

Anmerkung:

Achtung: Die mit (!) gekennzeichneten Maße oder Ausführungen haben eine längere Produktionszeit: zirka 6 Wochen ab Auftragsdatum.

Bez. Nahtfarbe und Kanten siehe "Regeln Kernleder" Innenseite des Umschlags.

Für verstärkte Verpackungen siehe Innenseite des Umschlags.

Art.-Nr.	Gestell	Bezug		kolli	m ²	Kg
		"Cuoietto" Kernleder (!)	"Vollnarbiges" Kernleder (PF) (!)			
05ELE92	Buchenholz			1	0,56	14
	Europäische Eiche, Farbe Nussbaum, Lackiertes Holz					

Ein Sessel pro Frachtstück

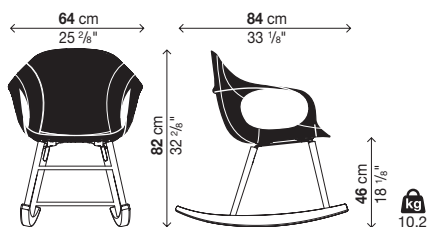

ELEPHANT

Rocking - Aufbau mit Stoffbezug (nicht abziehbar)

Ausführung Gestell:

Massives Buchenholz
 Massives europäisches Eichenholz
 Massives Eichenholz Farbe Nussbaum
 Massivholz lackiert (in den Polyurethan-Farben)

Ausführung des Bezugs:

B = COM (Kundenstoff)
 D = Remix 2
 E = Canvas 2, Hero, Melange Nap
 F = Regal, Steelcut Trio 3
 G = Divina Melange 3, Hallingdal 65
 H = Twill Weave

Anmerkung:

Für Bestellungen COM siehe Innenseite des Umschlags.

Für Informationen zur Zusammensetzung der Stoffe siehe Innenseite des Umschlags.

Verbrauch COM: 1,5 ml (H. 140 cm).

Für verstärkte Verpackungen siehe Innenseite des Umschlags.

Art.-Nr.	Gestell	Bezug										kolli	m ³	Kg	
		A	B	C	D	E	F	G	H	L1	L2				L3
05ELE93	Buchenholz	-		-						-	-	-	1	0,56	13,5
	Europäische Eiche, Farbe Nussbaum, Lackiertes Holz	-		-						-	-	-			

Ein Sessel pro Frachtstück

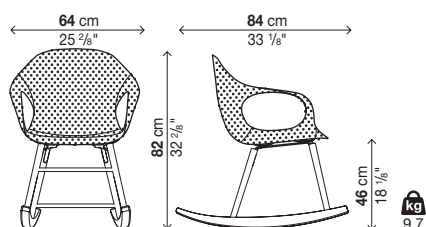

ELEPHANT

Drehbarer Ständer - Aufbau aus Polyurethan

Ausführung Gestell:

Aluminium glänzend
Lackiertes Aluminium (in den Polyurethan-Farben)

Ausführung Aufbau:

Polyurethan Weiß (P001)
Polyurethan Schwarz (P003)
Polyurethan Beige (P004)
Polyurethan Terracotta (P006)
Polyurethan Olivgrün (P008)
Polyurethan Rubinrot (P010)
Polyurethan Grau London (P011)
Polyurethan Wolkenblau (P012)

Ausführung Kissen Elephant:

A = Valencia (Synthetische Leder), COM (Kundenstoff)
B = Field 2
C = Clara 2, Merit
D = Curmi, Patio, Remix 2
E = Canvas 2, Hero, Melange Nap
F = Regal, Scuba, Steelcut Trio 3
G = Divina Melange 3, Hallingdal 65
H = Twill Weave

Ausführung Kissen Lips:

A = COM (Kundenstoff)
B = Field 2

Anmerkung:

Für Bestellungen COM siehe Innenseite des Umschlags.

Für Informationen zur Zusammensetzung der Stoffe siehe Innenseite des Umschlags.

FÜßE:

Standard in Filz für Holzböden.

VERSANDINFO DEMONTIERT:

Bei Bestellungen mit mehr als 8 Produkte, werden diese zerlegt geliefert - Sitz und Untergestell getrennt. (nur bei der Version mit Polyurethansitz gueltig).

- 4 aufbau = 1 kolli - Kg 19 / m³ 0,41
- 1 untergestell = 1 kolli - Kg 6 / m³ 0,14

Verbrauch Kissen Elephant: 0,55 ml (H. 140 cm).

Verbrauch Kissen Lips: 0,5 ml (H. 140 cm).

Für verstärkte Verpackungen siehe Innenseite des Umschlags.

Art.-Nr.	Gestell	Aufbau		kolli	m ³	Kg
		Polyurethan				
05ELE72	Aluminium lackiert			1	0,38	11,5
	Aluminium glänzend					

Ein Sessel pro Frachtstück

Optionen

Art.-Nr.	Beschreibung	Bezug											kolli	m ³	Kg	
		A	B	C	D	E	F	G	H	L1	L2	L3				
20ELE01	Abnehmbares Kissen Elephant (nicht abziehbar)										-	-	-	1	0,02	1
20LIR01	Abnehmbares Kissen LIPS-R (nicht abziehbar)			-	-	-	-	-	-	-	-	-	-	1	0,01	1
20LIS01	Abnehmbares Kissen LIPS-S (nicht abziehbar)			-	-	-	-	-	-	-	-	-	-	1	0,01	1

ELEPHANT (20ELE01)



kg
0,6

LIPS-R (20LIR01)

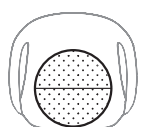

kg
0,6

LIPS-S (20LIS01)

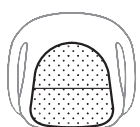

kg
0,6

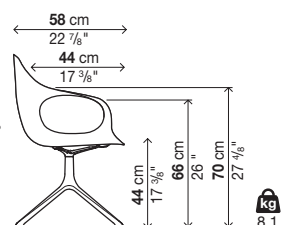
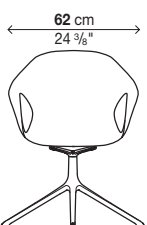
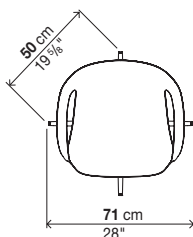

ELEPHANT

Drehbarer Ständer - Aufbau mit Lederbezug (nicht abziehbar)

Ausführung Gestell:

Aluminium glänzend
Lackiertes Aluminium (in den Polyurethan-Farben)

Ausführung des Bezugs:

Cuoietto Kernleder (C)
"Vollnarbiges" Kernleder (PF) Natur oder schwarz

Anmerkung:

Achtung: Die mit (!) gekennzeichneten Maße oder Ausführungen haben eine längere Produktionszeit: zirka 6 Wochen ab Auftragsdatum.

Bez. Nahtfarbe und Kanten siehe "Regeln Kernleder" Innenseite des Umschlags.

FÜßE:
Standard in Filz für Holzböden.

Für verstärkte Verpackungen siehe Innenseite des Umschlags.

Art.-Nr.	Gestell	Bezug		koli	m³	Kg
		"Cuoietto" Kernleder (!)	"Vollnarbiges" Kernleder (PF) (!)			
05ELE71	Aluminium lackiert			1	0,38	14
	Aluminium glänzend					

Ein Sessel pro Frachtstück

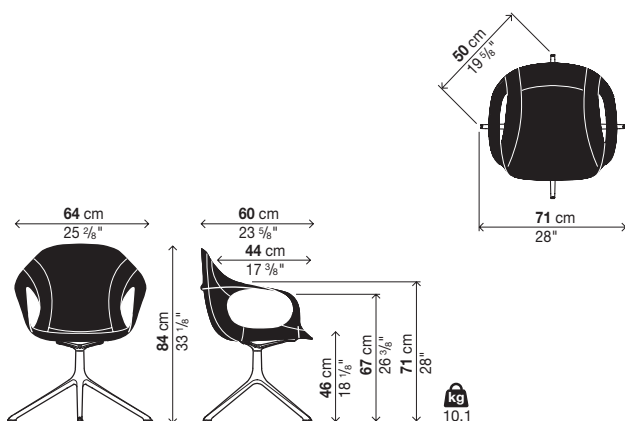

ELEPHANT

Drehbarer Ständer - Aufbau mit Stoffbezug (nicht abziehbar)

Ausführung Gestell:

Aluminium glänzend

Lackiertes Aluminium (in den Polyurethan-Farben)

Ausführung des Bezugs:

B = COM (Kundenstoff)

D = Remix 2

E = Canvas 2, Hero, Melange Nap

F = Regal, Steelcut Trio 3

G = Divina Melange 3, Hallingdal 65

H = Twill Weave

Anmerkung:

Für Bestellungen COM siehe Innenseite des Umschlags.

Für Informationen zur Zusammensetzung der Stoffe siehe Innenseite des Umschlags.

FÜßE:

Standard in Filz für Holzböden.

Verbrauch COM: 1,5 ml (H. 140 cm).

Für verstärkte Verpackungen siehe Innenseite des Umschlags.

Art.-Nr.	Gestell	Bezug											koli	m ²	Kg	
		A	B	C	D	E	F	G	H	L1	L2	L3				
05ELE54	Aluminium lackiert	-		-							-	-	-	1	0,38	13,5
	Aluminium glänzend	-		-							-	-	-			

Ein Sessel pro Frachtstück

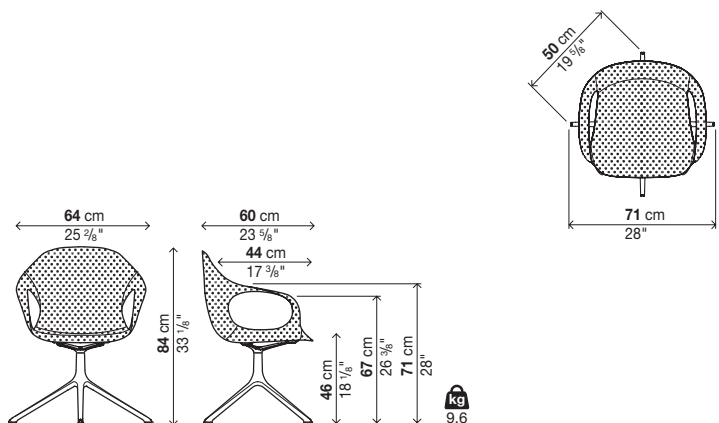

ELEPHANT

Fünf Ausleger mit Rollen - Aufbau aus Polyurethan

Ausführung Gestell:

Aluminium glänzend
Lackiertes Aluminium (Weiß, Schwarz)

Ausführung Aufbau:

Polyurethan Weiß (P001)
Polyurethan Schwarz (P003)
Polyurethan Beige (P004)
Polyurethan Terracotta (P006)
Polyurethan Olivgrün (P008)
Polyurethan Rubinrot (P010)
Polyurethan Grau London (P011)
Polyurethan Wolkenblau (P012)

Ausführung Kissen Elephant:

A = Valencia (Synthetische Leder), COM (Kundenstoff)
B = Field 2
C = Clara 2, Merit
D = Curmi, Patio, Remix 2
E = Canvas 2, Hero, Melange Nap
F = Regal, Scuba, Steelcut Trio 3
G = Divina Melange 3, Hallingdal 65
H = Twill Weave

Ausführung Kissen Lips:

A = COM (Kundenstoff)
B = Field 2

Anmerkung:

Für Bestellungen COM siehe Innenseite des Umschlags.

Für Informationen zur Zusammensetzung der Stoffe siehe Innenseite des Umschlags.

Drehrollen mit automatischem Bremssystem und weicher Lauffläche.

VERSANDINFO DEMONTIERT:

Bei Bestellungen mit mehr als 8 Produkte, werden diese zerlegt geliefert - Sitz und Untergestell getrennt. (nur bei der Version mit Polyurethansitz gueltig).

- 4 aufbau = 1 kolli - Kg 19 / m³ 0,41
- 1 untergestell = 1 kolli - Kg 15 / m³ 0,14

Verbrauch Kissen Elephant: 0,55 ml (H. 140 cm).

Verbrauch Kissen Lips: 0,5 ml (H. 140 cm).

Für verstärkte Verpackungen siehe Innenseite des Umschlags.

Art.-Nr.	Gestell	Aufbau	
			kolli m ³ Kg
05ELE41	Aluminium lackiert	Polyurethan	1 0,38 13
	Aluminium glänzend		

Ein Sessel pro Frachtstück

Optionen

Art.-Nr.	Beschreibung	Bezug											kolli m ³ Kg
		A	B	C	D	E	F	G	H	L1	L2	L3	
20ELE01	Abnehmbares Kissen Elephant (nicht abziehbar)									-	-	-	1 0,02 1
20LIR01	Abnehmbares Kissen LIPS-R (nicht abziehbar)			-	-	-	-	-	-	-	-	-	1 0,01 1
20LIS01	Abnehmbares Kissen LIPS-S (nicht abziehbar)			-	-	-	-	-	-	-	-	-	1 0,01 1

ELEPHANT (20ELE01)

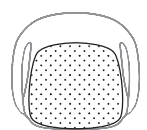

LIPS-R (20LIR01)

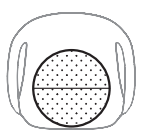

LIPS-S (20LIS01)

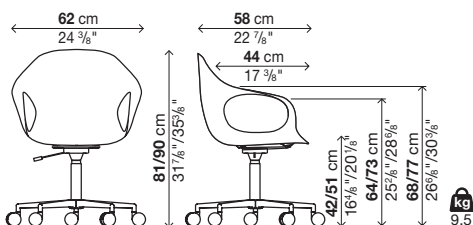
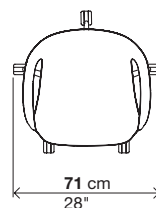

ELEPHANT

Fünf Ausleger mit Rollen - Aufbau mit Lederbezug (nicht abziehbar)

Ausführung Gestell:

Aluminium glänzend
Lackiertes Aluminium (Weiß, Schwarz)

Ausführung des Bezugs:

Cuoietto Kernleder (C)
"Vollnarbiges" Kernleder (PF) Natur oder schwarz

Anmerkung:

Achtung: Die mit (!) gekennzeichneten Maße oder Ausführungen haben eine längere Produktionszeit: zirka 6 Wochen ab Auftragsdatum.

Bez. Nahtfarbe und Kanten siehe "Regeln Kernleder" Innenseite des Umschlags.

Drehrollen mit automatischem Bremssystem und weicher Lauffläche.

Für verstärkte Verpackungen siehe Innenseite des Umschlags.

Art.-Nr.	Gestell	Bezug		kolli	m ³	Kg
		"Cuoietto" Kernleder (!)	"Vollnarbiges" Kernleder (PF) (!)			
05ELE42	Aluminium lackiert			1	0,38	15,5
	Aluminium glänzend					

Ein Sessel pro Frachtstück

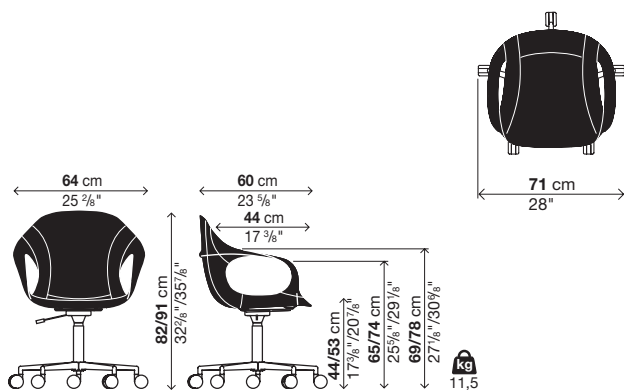

ELEPHANT

Fünf Ausleger mit Rollen - Aufbau mit Stoffbezug (nicht abziehbar)

Ausführung Gestell:

Aluminium glänzend
Lackiertes Aluminium (Weiß, Schwarz)

Ausführung des Bezugs:

B = COM (Kundenstoff)
D = Remix 2
E = Canvas 2, Hero, Melange Nap
F = Regal, Steelcut Trio 3
G = Divina Melange 3, Hallingdal 65
H = Twill Weave

Anmerkung:

Für Bestellungen COM siehe Innenseite des Umschlags.

Für Informationen zur Zusammensetzung der Stoffe siehe Innenseite des Umschlags.

Drehrollen mit automatischem Bremssystem und weicher Lauffläche.

Verbrauch COM: 1,5 ml (H. 140 cm).

Für verstärkte Verpackungen siehe Innenseite des Umschlags.

Art.-Nr.	Gestell	Bezug										koli	m ²	Kg		
		A	B	C	D	E	F	G	H	L1	L2				L3	
05ELE43	Aluminium lackiert	-		-							-	-	-	1	0,38	15
	Aluminium glänzend	-		-							-	-	-			

Ein Sessel pro Frachtstück

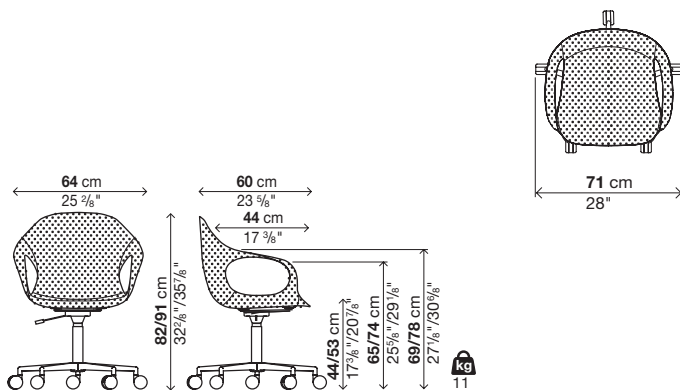

ELEPHANT

Sessel lounge - Aufbau aus Polyurethan

Ausführung Gestell:

Verchromter Stahl
Schwarz verchromter Stahl
Stahl mit Messingeffekt
Lackierter Stahl (in den Polyurethan-Farben)

Ausführung Aufbau:

Polyurethan Weiß (P001)
Polyurethan Schwarz (P003)
Polyurethan Beige (P004)
Polyurethan Terracotta (P006)
Polyurethan Olivgrün (P008)
Polyurethan Rubinrot (P010)
Polyurethan Grau London (P011)
Polyurethan Wolkenblau (P012)

Ausführung Kissen Elephant:

A = Valencia (Synthetische Leder), COM (Kundenstoff)
B = Field 2
C = Clara 2, Merit
D = Curmi, Patio, Remix 2
E = Canvas 2, Hero, Melange Nap
F = Regal, Scuba, Steelcut Trio 3
G = Divina Melange 3, Hallingdal 65
H = Twill Weave

Ausführung Kissen Lips:

A = COM (Kundenstoff)
B = Field 2

Anmerkung:

Für Bestellungen COM siehe Innenseite des Umschlags.

Für Informationen zur Zusammensetzung der Stoffe siehe Innenseite des Umschlags.

FÜßE:

Standard in Hartplastik. Auf Wunsch liefern wir Füße mit Filzeinlage für Holzböden.

VERSANDINFO DEMONTIERT:

Bei Bestellungen mit mehr als 8 Produkte, werden diese zerlegt geliefert - Sitz und Untergestell getrennt. (nur bei der Version mit Polyurethansitz gueltig).

- 4 aufbau = 1 kolli - Kg 19 / m³ 0,41
- 4 untergestell = 1 kolli - Kg 14 / m³ 0,28

Verbrauch Kissen Elephant: 0,55 ml (H. 140 cm).

Verbrauch Kissen Lips: 0,5 ml (H. 140 cm).

Für verstärkte Verpackungen siehe Innenseite des Umschlags.

Art.-Nr.	Gestell	Aufbau			
		Polyurethan			kolli m ³ Kg
05ELE03	Lackierter Stahl, Verchromter Stahl, Schwarz verchromter Stahl				1 0,4 10
	Stahl mit Messingeffekt				

Ein Sessel pro Frachtstück

Optionen

Art.-Nr.	Beschreibung	Bezug										kolli m ³ Kg	
		A	B	C	D	E	F	G	H	L1	L2		L3
20ELE01	Abnehmbares Kissen Elephant (nicht abziehbar)									-	-	-	1 0,02 1
20LIR01	Abnehmbares Kissen LIPS-R (nicht abziehbar)			-	-	-	-	-	-	-	-	-	1 0,01 1
20LIS01	Abnehmbares Kissen LIPS-S (nicht abziehbar)			-	-	-	-	-	-	-	-	-	1 0,01 1
02PIE14	Set Filzfüße												- - -

ELEPHANT (20ELE01)

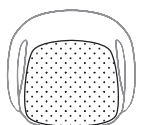

kg
0,6

LIPS-R (20LIR01)

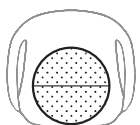

kg
0,6

LIPS-S (20LIS01)



kg
0,6

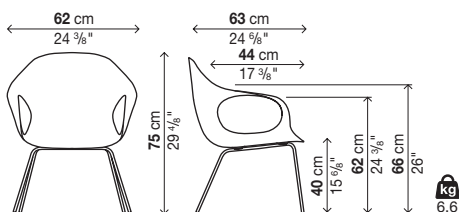

ELEPHANT

Sessel lounge - Aufbau mit Lederbezug (nicht abziehbar)

Ausführung Gestell:

Verchromter Stahl
 Schwarz verchromter Stahl
 Stahl mit Messingeffekt
 Lackierter Stahl (in den Polyurethan-Farben)

Ausführung des Bezugs:

Cuoietto Kernleder (C)
 "Vollnarbiges" Kernleder (PF) Natur oder schwarz

Anmerkung:

Achtung: Die mit (!) gekennzeichneten Maße oder Ausführungen haben eine längere Produktionszeit: zirka 6 Wochen ab Auftragsdatum.

Bez. Nahtfarbe und Kanten siehe "Regeln Kernleder" Innenseite des Umschlags.

Für verstärkte Verpackungen siehe Innenseite des Umschlags.

Art.-Nr.	Gestell	Bezug		kolli	m ²	Kg
		"Cuoietto" Kernleder (!)	"Vollnarbiges" Kernleder (PF) (!)			
05ELE13	Lackierter Stahl, Verchromter Stahl, Schwarz verchromter Stahl			1	0,4	11,5
	Stahl mit Messingeffekt					

Ein Sessel pro Frachtstück

Optionen

Art.-Nr.	Beschreibung	kolli	m ²	Kg
02PIE14	Set Filzfüße	-	-	-

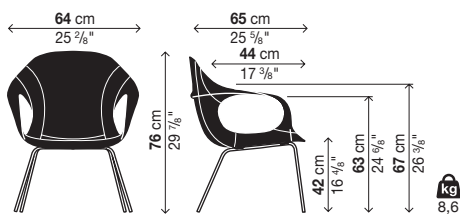

ELEPHANT

Sessel lounge - Aufbau mit Stoffbezug (nicht abziehbar)

Ausführung Gestell:

Verchromter Stahl
 Schwarz verchromter Stahl
 Stahl mit Messingeffekt
 Lackierter Stahl (in den Polyurethan-Farben)

Ausführung des Bezugs:

B = COM (Kundenstoff)
 D = Remix 2
 E = Canvas 2, Hero, Melange Nap
 F = Regal, Steelcut Trio 3
 G = Divina Melange 3, Hallingdal 65
 H = Twill Weave

Anmerkung:

Für Bestellungen COM siehe Innenseite des Umschlags.

Für Informationen zur Zusammensetzung der Stoffe siehe Innenseite des Umschlags.

FÜßE:

Standard in Hartplastik. Auf Wunsch liefern wir Füße mit Filzeinlage für Holzböden.

Verbrauch COM: 1,5 ml (H. 140 cm).

Für verstärkte Verpackungen siehe Innenseite des Umschlags.

Art.-Nr.	Gestell	Bezug											kolli	m³	Kg
		A	B	C	D	E	F	G	H	L1	L2	L3			
05ELE23	Lackierter Stahl, Verchromter Stahl, Schwarz verchromter Stahl	-		-						-	-	-	1	0,4	11
	Stahl mit Messingeffekt	-		-						-	-	-			

Ein Sessel pro Frachtstück

Optionen

Art.-Nr.	Beschreibung	kolli	m³	Kg
02PIE14	Set Filzfüße	-	-	-

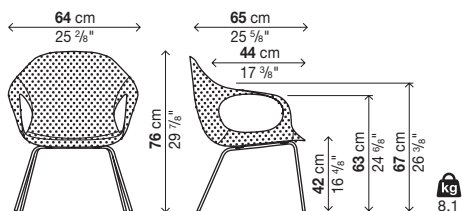

ELEPHANT

Légende

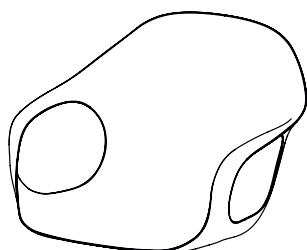
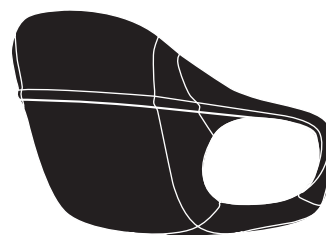

Coque en polyuréthane

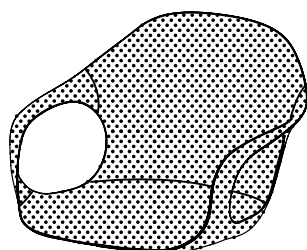

Coque revêtue en tissu

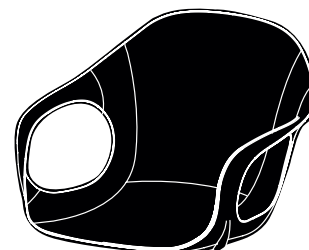

Coque revêtue en cuir



Quatre pieds

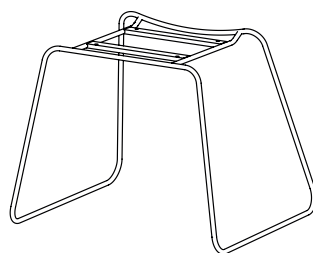

Luge

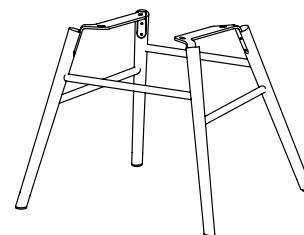

Piètement bois

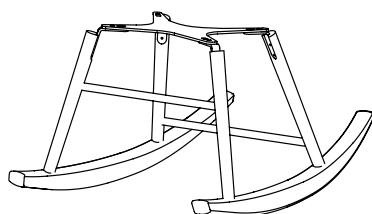

Rocking

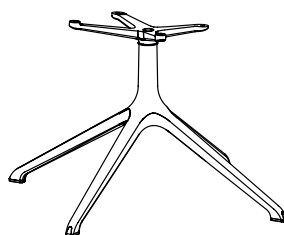

Tréteau pivotant

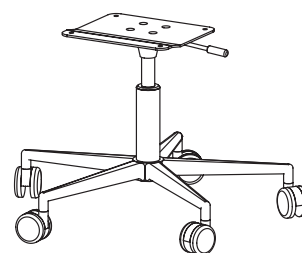

Cinq branches avec roulettes

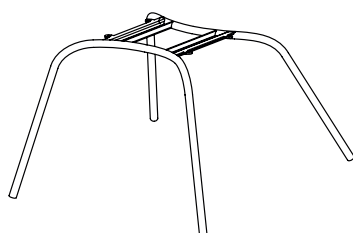

Lounge

ELEPHANT

Quatre pieds - Coque en polyuréthane

Finition piètement:

Acier chromé
Acier chromé noir
Acier chromé satiné
Acier aspect laiton
Acier laqué (dans les coloris du polyuréthane)

Finition coque:

Polyuréthane blanc (P001)
Polyuréthane noir (P003)
Polyuréthane beige (P004)
Polyuréthane terre cuite (P006)
Polyuréthane vert olive (P008)
Polyuréthane rouge rubis (P010)
Polyuréthane gris Londres (P011)
Polyuréthane bleu poussière (P012)

Finition revêtement coussin Elephant:

A = Valencia (cuir synthétique), COM (tissu Client)
B = Field 2
C = Clara 2, Merit
D = Curmi, Patio, Remix 2
E = Canvas 2, Hero, Melange Nap
F = Regal, Scuba, Steelcut Trio 3
G = Divina Melange 3, Hallingdal 65
H = Twill Weave

Finition revêtement coussin Lips:

A = COM (tissu Client)
B = Field 2

Notes:

Pour les commandes COM, voir intérieur de la couverture.

Pour toute information sur les compositions des tissus, voir intérieur de la couverture.

PIEDS:

Standard en plastique dur. Sur demande, nous fournissons des pieds avec insert en feutre pour sols en bois.

INFORMATIONS SUR L'EXPÉDITION DÉMONTÉES:

Pour des commandes de plus de 8 articles, les chaises seront livrées démontées. (seulement pour fauteuils avec coque en polyuréthane).
- 4 coques = 1 colis - Kg 19 / m³ 0,41.
- 4 piètements = 1 colis - Kg 14 / m³ 0,26.

Consommation coussin Elephant: 0,55 ml (H. 140 cm).

Consommation coussin Lips: 0,5 ml (H. 140 cm).

Emballages renforcés, voir intérieur de la couverture.

Code	Piètement	Coque	
		colis	m ³ Kg
		Polyuréthane	
05ELE11	Acier laqué, Acier chromé, Acier chromé noir	1	0,4 10
	Acier aspect laiton, Acier chromé satiné		

chaque colis 1 fauteuil

Optionals

Code	Description	Revêtement											colis	m ³	Kg			
		A	B	C	D	E	F	G	H	L1	L2	L3						
20ELE01	Coussin amovible Elephant (non déhoussable)												-	-	-	1	0,02	1
20LIR01	Coussin amovible LIPS-R (non déhoussable)			-	-	-	-	-	-	-	-	-	-	-	-	1	0,01	1
20LIS01	Coussin amovible LIPS-S (non déhoussable)			-	-	-	-	-	-	-	-	-	-	-	-	1	0,01	1
02PIE03	Lot de patins en feutre															-	-	-

ELEPHANT (20ELE01)

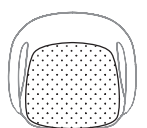

LIPS-R (20LIR01)

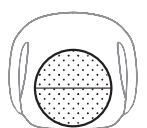

LIPS-S (20LIS01)

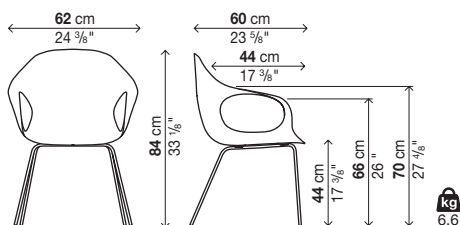
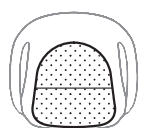

ELEPHANT

Quatre pieds - Coque revêtue en cuir (non déhoussable)

Finition piètement:

Acier chromé
 Acier chromé noir
 Acier chromé satiné
 Acier aspect laiton
 Acier laqué (dans les coloris du polyuréthane)

Finition du revêtement:

Cuir "Cuoietto" (C)
 Cuir "Pleine fleur" (PF) naturel ou noir

Notes:

Attention: les dimensions et les finitions marquées par un point d'exclamation (!) ont des délais de production plus longs (environ 6 semaines à partir de la date de la commande).

Pour couleur couture et bord voir "règles cuir" intérieur de la couverture.

PIEDS:

Standard en plastique dur. Sur demande, nous fournissons des pieds avec insert en feutre pour sols en bois.

Emballages renforcés, voir intérieur de la couverture.

Code	Piètement	Revêtement		colis	m ²	Kg
		Cuir "Cuoietto" (C) (!)	Cuir "pleine fleur" (PF) (!)			
05ELE01	Acier laqué, Acier chromé, Acier chromé noir			1	0,4	11,5
	Acier aspect laiton, Acier chromé satiné					

chaque colis 1 fauteuil

Optionals

Code	Description	colis	m ²	Kg
02PIE03	Lot de patins en feutre	-	-	-

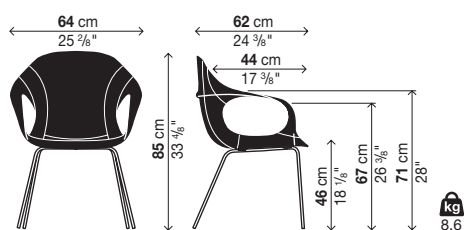

ELEPHANT

Quatre pieds - Coque revêtue en tissu (non déhoussable)

Finition piètement:

Acier chromé
 Acier chromé noir
 Acier chromé satiné
 Acier aspect laiton
 Acier laqué (dans les coloris du polyuréthane)

Finition du revêtement:

B = COM (tissu Client)
 D = Remix 2
 E = Canvas 2, Hero, Melange Nap
 F = Regal, Steelcut Trio 3
 G = Divina Melange 3, Hallingdal 65
 H = Twill Weave

Notes:

Pour les commandes COM, voir intérieur de la couverture.

Pour toute information sur les compositions des tissus, voir intérieur de la couverture.

PIEDS:

Standard en plastique dur. Sur demande, nous fournissons des pieds avec insert en feutre pour sols en bois.

Consommation COM: 1,5 ml (H. 140 cm).

Emballages renforcés, voir intérieur de la couverture.

Code	Piètement	Revêtement											colis	m ²	Kg	
		A	B	C	D	E	F	G	H	L1	L2	L3				
05ELE51	Acier laqué, Acier chromé, Acier chromé noir	-		-							-	-	-	1	0,4	11
	Acier aspect laiton, Acier chromé satiné	-		-							-	-	-			

chaque colis 1 fauteuil

Optionals

Code	Description	colis	m ²	Kg
02PIE03	Lot de patins en feutre	-	-	-

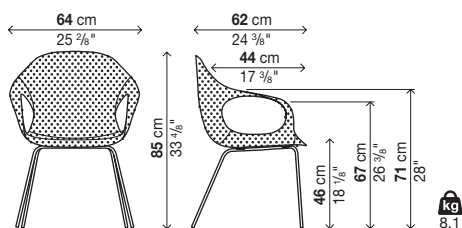

ELEPHANT

Luge - Coque en polyuréthane

Finition piètement:

Acier chromé
Acier chromé noir
Acier chromé satiné
Acier aspect laiton
Acier laqué (dans les coloris du polyuréthane)

Finition coque:

Polyuréthane blanc (P001)
Polyuréthane noir (P003)
Polyuréthane beige (P004)
Polyuréthane terre cuite (P006)
Polyuréthane vert olive (P008)
Polyuréthane rouge rubis (P010)
Polyuréthane gris Londres (P011)
Polyuréthane bleu poussière (P012)

Finition revêtement coussin Elephant:

A = Valencia (cuir synthétique), COM (tissu Client)
B = Field 2
C = Clara 2, Merit
D = Curmi, Patio, Remix 2
E = Canvas 2, Hero, Melange Nap
F = Regal, Scuba, Steelcut Trio 3
G = Divina Melange 3, Hallingdal 65
H = Twill Weave

Finition revêtement coussin Lips:

A = COM (tissu Client)
B = Field 2

Notes:

Pour les commandes COM, voir intérieur de la couverture.

Pour toute information sur les compositions des tissus, voir intérieur de la couverture.

PIEDS:

Standard en plastique dur. Sur demande, nous fournissons des pieds avec insert en feutre pour sols en bois.

INFORMATIONS SUR L'EXPÉDITION DÉMONTÉES:

Pour des commandes de plus de 8 articles, les chaises seront livrées démontées. (seulement pour fauteuils avec coque en polyuréthane).
- 4 coques = 1 colis - Kg 19 / m³ 0,41
- 4 piètements = 1 colis - Kg 19 / m³ 0,26

Consommation coussin Elephant: 0,55 ml (H. 140 cm).

Consommation coussin Lips: 0,5 ml (H. 140 cm).

Emballages renforcés, voir intérieur de la couverture.

Code	Piètement	Coque	
		colis	m ³ Kg
		Polyuréthane	
05ELE12	Acier laqué, Acier chromé, Acier chromé noir	1	0,4 11,2
	Acier aspect laiton, Acier chromé satiné		

chaque colis 1 fauteuil

Optionals

Code	Description	Revêtement										colis	m ³	Kg		
		A	B	C	D	E	F	G	H	L1	L2				L3	
20ELE01	Coussin amovible Elephant (non déhoussable)										-	-	-	1	0,02	1
20LIR01	Coussin amovible LIPS-R (non déhoussable)			-	-	-	-	-	-	-	-	-	-	1	0,01	1
20LIS01	Coussin amovible LIPS-S (non déhoussable)			-	-	-	-	-	-	-	-	-	-	1	0,01	1
02PIE03	Lot de patins en feutre													-	-	-

ELEPHANT (20ELE01)

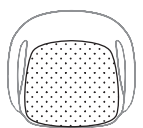

LIPS-R (20LIR01)

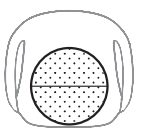

LIPS-S (20LIS01)

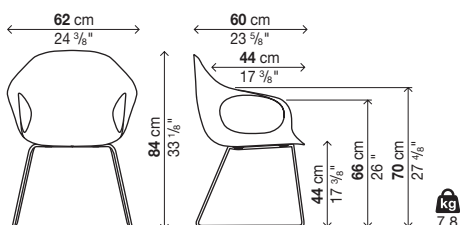
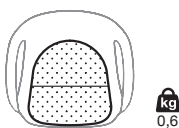

ELEPHANT

Luge - Coque revêtue en cuir (non déhoussable)

Finition piètement:

Acier chromé
 Acier chromé noir
 Acier chromé satiné
 Acier aspect laiton
 Acier laqué (dans les coloris du polyuréthane)

Finition du revêtement:

Cuir "Cuoietto" (C)
 Cuir "Pleine fleur" (PF) naturel ou noir

Notes:

Attention: les dimensions et les finitions marquées par un point d'exclamation (!) ont des délais de production plus longs (environ 6 semaines à partir de la date de la commande).

Pour couleur couture et bord voir "règles cuir" intérieur de la couverture.

PIEDS:

Standard en plastique dur. Sur demande, nous fournissons des pieds avec insert en feutre pour sols en bois.

Emballages renforcés, voir intérieur de la couverture.

Code	Piètement	Revêtement		colis	m ²	Kg
		Cuir "Cuoietto" (C) (!)	Cuir "pleine fleur" (PF) (!)			
05ELE02	Acier laqué, Acier chromé, Acier chromé noir			1	0,4	13
	Acier aspect laiton, Acier chromé satiné					

chaque colis 1 fauteuil

Optionals

Code	Description	colis	m ²	Kg
02PIE03	Lot de patins en feutre	-	-	-

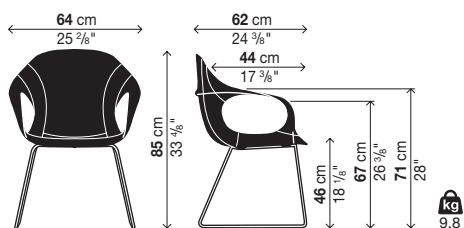

ELEPHANT

Luge - Coque revêtue en tissu (non déhoussable)

Finition piètement:

Acier chromé
Acier chromé noir
Acier chromé satiné
Acier aspect laiton
Acier laqué (dans les coloris du polyuréthane)

Finition du revêtement:

B = COM (tissu Client)
D = Remix 2
E = Canvas 2, Hero, Melange Nap
F = Regal, Steelcut Trio 3
G = Divina Melange 3, Hallingdal 65
H = Twill Weave

Notes:

Pour les commandes COM, voir intérieur de la couverture.

Pour toute information sur les compositions des tissus, voir intérieur de la couverture.

PIEDS:

Standard en plastique dur. Sur demande, nous fournissons des pieds avec insert en feutre pour sols en bois.

Consommation COM: 1,5 ml (H. 140 cm).

Emballages renforcés, voir intérieur de la couverture.

Code	Piètement	Revêtement										colis	m ²	Kg		
		A	B	C	D	E	F	G	H	L1	L2				L3	
05ELE52	Acier laqué, Acier chromé, Acier chromé noir	-		-							-	-	-	1	0,4	12,5
	Acier aspect laiton, Acier chromé satiné	-		-							-	-	-			

chaque colis 1 fauteuil

Optionals

Code	Description	colis	m ²	Kg
02PIE04	Lot de patins en feutre	-	-	-

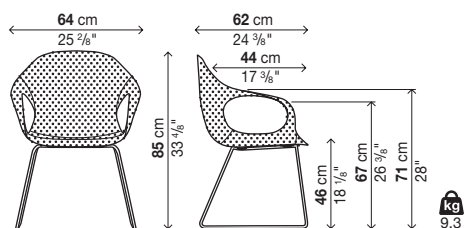

ELEPHANT

Piètement bois - Coque en polyuréthane

Finition piètement:

Hêtre massif

Bois massif chêne européen

Chêne massif teinté noyer

Bois massif teinté (dans les coloris du polyuréthane)

Finition coque:

Polyuréthane blanc (P001)

Polyuréthane noir (P003)

Polyuréthane beige (P004)

Polyuréthane terre cuite (P006)

Polyuréthane vert olive (P008)

Polyuréthane rouge rubis (P010)

Polyuréthane gris Londres (P011)

Polyuréthane bleu poussière (P012)

Finition revêtement coussin Elephant:

A = Valencia (cuir synthétique), COM (tissu Client)

B = Field 2

C = Clara 2, Merit

D = Curmi, Patio, Remix 2

E = Canvas 2, Hero, Melange Nap

F = Regal, Scuba, Steelcut Trio 3

G = Divina Melange 3, Hallingdal 65

H = Twill Weave

Finition revêtement coussin Lips:

A = COM (tissu Client)

B = Field 2

Notes:

Pour les commandes COM, voir intérieur de la couverture.

Pour toute information sur les compositions des tissus, voir intérieur de la couverture.

PIEDS:

Standard en plastique dur. Sur demande, nous fournissons des pieds avec insert en feutre pour sols en bois.

INFORMATIONS SUR L'EXPÉDITION DÉMONTÉES:

Pour des commandes de plus de 8 articles, les chaises seront livrées démontées. (seulement pour fauteuils avec coque en polyuréthane).

- 4 coques = 1 colis - Kg 19 / m³ 0,41

- 4 piètements = 1 colis - Kg 12 / m³ 0,33

Consommation coussin Elephant: 0,55 ml (H. 140 cm).

Consommation coussin Lips: 0,5 ml (H. 140 cm).

Emballages renforcés, voir intérieur de la couverture.

Code	Piètement	Coque		
		colis	m ³	Kg
		Polyuréthane		
05ELE82	Hêtre			
	Chêne européen, Chêne teinté noyer, Bois laqué	1	0,4	9,3

chaque colis 1 fauteuil

Optionals

Code	Description	Revêtement											colis	m ³	Kg	
		A	B	C	D	E	F	G	H	L1	L2	L3				
20ELE01	Coussin amovible Elephant (non déhoussable)										-	-	-	1	0,02	1
20LIR01	Coussin amovible LIPS-R (non déhoussable)			-	-	-	-	-	-	-	-	-	-	1	0,01	1
20LIS01	Coussin amovible LIPS-S (non déhoussable)			-	-	-	-	-	-	-	-	-	-	1	0,01	1
02PIE05	Lot de patins en feutre															

ELEPHANT (20ELE01)

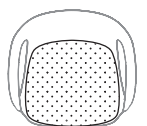

kg
0,6

LIPS-R (20LIR01)

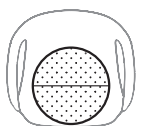

kg
0,6

LIPS-S (20LIS01)

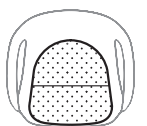

kg
0,6

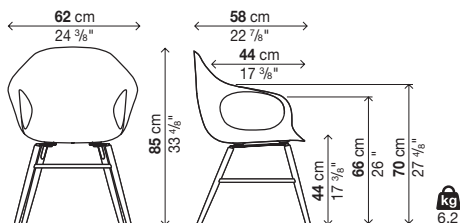

ELEPHANT

Piètement bois - Coque revêtue en cuir (non déhoussable)

Finition piètement:

Hêtre massif
Bois massif chêne européen
Chêne massif teinté noyer
Bois massif teinté (dans les coloris du polyuréthane)

Finition du revêtement:

Cuir "Cuoietto" (C)
Cuir "Pleine fleur" (PF) naturel ou noir

Notes:

Attention: les dimensions et les finitions marquées par un point d'exclamation (!) ont des délais de production plus longs (environ 6 semaines à partir de la date de la commande).

Pour couleur couture et bord voir "règles cuir" intérieur de la couverture.

PIEDS:

Standard en plastique dur. Sur demande, nous fournissons des pieds avec insert en feutre pour sols en bois.

Emballages renforcés, voir intérieur de la couverture.

Code	Piètement	Revêtement		colis	m ²	Kg
		Cuir "Cuoietto" (C) (!)	Cuir "pleine fleur" (PF) (!)			
05ELE81	Hêtre			1	0,38	11,2
	Chêne européen, Chêne teinté noyer, Bois laqué					

chaque colis 1 fauteuil

Optionals

Code	Description	colis	m ²	Kg
02PIE05	Lot de patins en feutre	-	-	-

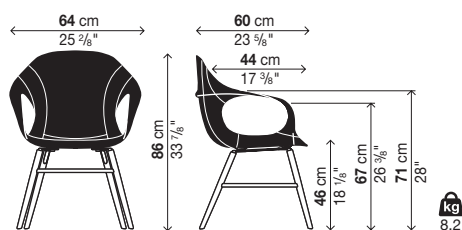

ELEPHANT

Piètement bois - Coque revêtue en tissu (non déhoussable)

Finition piètement:

Hêtre massif
Bois massif chêne européen
Chêne massif teinté noyer
Bois massif teinté (dans les coloris du polyuréthane)

Finition du revêtement:

B = COM (tissu Client)
D = Remix 2
E = Canvas 2, Hero, Melange Nap
F = Regal, Steelcut Trio 3
G = Divina Melange 3, Hallingdal 65
H = Twill Weave

Notes:

Pour les commandes COM, voir intérieur de la couverture.

Pour toute information sur les compositions des tissus, voir intérieur de la couverture.

PIEDS:

Standard en plastique dur. Sur demande, nous fournissons des pieds avec insert en feutre pour sols en bois.

Consommation COM: 1,5 ml (H. 140 cm).

Emballages renforcés, voir intérieur de la couverture.

Code	Piètement	Revêtement											colis m³ Kg			
		A	B	C	D	E	F	G	H	L1	L2	L3				
05ELE53	Hêtre	-		-							-	-	-	1	0,4	10,7
	Chêne européen, Chêne teinté noyer, Bois laqué	-		-							-	-	-			

chaque colis 1 fauteuil

Optionals

Code	Description	colis m³ Kg		
02PIE05	Lot de patins en feutre	-	-	-

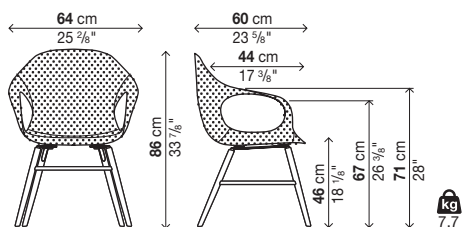

ELEPHANT

Rocking - Coque en polyuréthane

Finition piètement:

Hêtre massif
Bois massif chêne européen
Chêne massif teinté noyer
Bois massif teinté (dans les coloris du polyuréthane)

Finition coque:

Polyuréthane blanc (P001)
Polyuréthane noir (P003)
Polyuréthane beige (P004)
Polyuréthane terre cuite (P006)
Polyuréthane vert olive (P008)
Polyuréthane rouge rubis (P010)
Polyuréthane gris Londres (P011)
Polyuréthane bleu poussière (P012)

Finition revêtement coussin Elephant:

A = Valencia (cuir synthétique), COM (tissu Client)
B = Field 2
C = Clara 2, Merit
D = Curmi, Patio, Remix 2
E = Canvas 2, Hero, Melange Nap
F = Regal, Scuba, Steelcut Trio 3
G = Divina Melange 3, Hallingdal 65
H = Twill Weave

Finition revêtement coussin Lips:

A = COM (tissu Client)
B = Field 2

Notes:

Pour les commandes COM, voir intérieur de la couverture.

Pour toute information sur les compositions des tissus, voir intérieur de la couverture.

INFORMATIONS SUR L'EXPÉDITION DÉMONTÉES:

Pour des commandes de plus de 8 articles, les chaises seront livrées démontées. (seulement pour fauteuils avec coque en polyuréthane).
- 4 coques = 1 colis - Kg 19 / m³ 0,41
- 2 piètements = 1 colis - Kg 10 / m³ 0,34

Consommation coussin Elephant: 0,55 ml (H. 140 cm).

Consommation coussin Lips: 0,5 ml (H. 140 cm).

Emballages renforcés, voir intérieur de la couverture.

Code	Piètement	Coque	
		colis	m ³ Kg
		Polyuréthane	
05ELE91	Hêtre	1	0,56 12
	Chêne européen, Chêne teinté noyer, Bois laqué		

chaque colis 1 fauteuil

Optionals

Code	Description	Revêtement										colis	m ³	Kg		
		A	B	C	D	E	F	G	H	L1	L2				L3	
20ELE01	Coussin amovible Elephant (non déhoussable)										-	-	-	1	0,02	1
20LIR01	Coussin amovible LIPS-R (non déhoussable)			-	-	-	-	-	-	-	-	-	-	1	0,01	1
20LIS01	Coussin amovible LIPS-S (non déhoussable)			-	-	-	-	-	-	-	-	-	-	1	0,01	1

ELEPHANT (20ELE01)

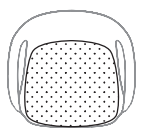

kg
0,6

LIPS-R (20LIR01)

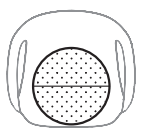

kg
0,6

LIPS-S (20LIS01)

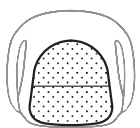

kg
0,6

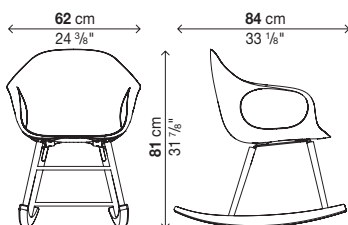

ELEPHANT

Rocking - Coque revêtue en cuir (non déhoussable)

Finition piètement:

Hêtre massif

Bois massif chêne européen

Chêne massif teinté noyer

Bois massif teinté (dans les coloris du polyuréthane)

Finition du revêtement:

Cuir "Cuoietto" (C)

Cuir "Pleine fleur" (PF) naturel ou noir

Notes:

Attention: les dimensions et les finitions marquées par un point d'exclamation (!) ont des délais de production plus longs (environ 6 semaines à partir de la date de la commande).

Pour couleur couture et bord voir "règles cuir" intérieur de la couverture.

Emballages renforcés, voir intérieur de la couverture.

Code	Piètement	Revêtement		colis	m ²	Kg
		Cuir "Cuoietto" (C) (!)	Cuir "pleine fleur" (PF) (!)			
05ELE92	Hêtre			1	0,56	14
	Chêne européen, Chêne teinté noyer, Bois laqué					

chaque colis 1 fauteuil

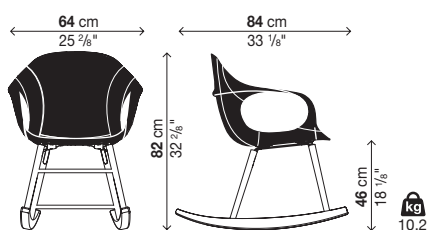

ELEPHANT

Rocking - Coque revêtue en tissu (non déhoussable)

Finition piètement:

Hêtre massif

Bois massif chêne européen

Chêne massif teinté noyer

Bois massif teinté (dans les coloris du polyuréthane)

Finition du revêtement:

B = COM (tissu Client)

D = Remix 2

E = Canvas 2, Hero, Melange Nap

F = Regal, Steelcut Trio 3

G = Divina Melange 3, Hallingdal 65

H = Twill Weave

Notes:

Pour les commandes COM, voir intérieur de la couverture.

Pour toute information sur les compositions des tissus, voir intérieur de la couverture.

Consommation COM: 1,5 ml (H. 140 cm).

Emballages renforcés, voir intérieur de la couverture.

Code	Piètement	Revêtement										colis	m ³	Kg	
		A	B	C	D	E	F	G	H	L1	L2				L3
05ELE93	Hêtre	-		-						-	-	-	1	0,56	13,5
	Chêne européen, Chêne teinté noyer, Bois laqué	-		-						-	-	-			

chaque colis 1 fauteuil

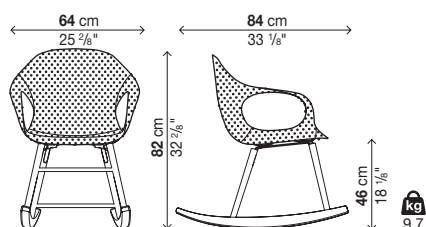

ELEPHANT

Tréteau pivotant - Coque en polyuréthane

Finition piètement:

Aluminium poli
Aluminium laqué (dans les coloris du polyuréthane)

Finition coque:

Polyuréthane blanc (P001)
Polyuréthane noir (P003)
Polyuréthane beige (P004)
Polyuréthane terre cuite (P006)
Polyuréthane vert olive (P008)
Polyuréthane rouge rubis (P010)
Polyuréthane gris Londres (P011)
Polyuréthane bleu poussière (P012)

Finition revêtement coussin Elephant:

A = Valencia (cuir synthétique), COM (tissu Client)
B = Field 2
C = Clara 2, Merit
D = Curmi, Patio, Remix 2
E = Canvas 2, Hero, Melange Nap
F = Regal, Scuba, Steelcut Trio 3
G = Divina Melange 3, Hallingdal 65
H = Twill Weave

Finition revêtement coussin Lips:

A = COM (tissu Client)
B = Field 2

Notes:

Pour les commandes COM, voir intérieur de la couverture.

Pour toute information sur les compositions des tissus, voir intérieur de la couverture.

PIEDS:

Standard en feutre pour sols en bois.

INFORMATIONS SUR L'EXPÉDITION DÉMONTÉES:

Pour des commandes de plus de 8 articles, les chaises seront livrées démontées. (seulement pour fauteuils avec coque en polyuréthane).
- 4 coques = 1 colis - Kg 19 / m³ 0,41
- 1 piètements = 1 colis - Kg 6 / m³ 0,14

Consommation coussin Elephant: 0,55 ml (H. 140 cm).

Consommation coussin Lips: 0,5 ml (H. 140 cm).

Emballages renforcés, voir intérieur de la couverture.

Code	Piètement	Coque	
		colis	m ³ Kg
		Polyuréthane	
05ELE72	Aluminium laqué	1	0,38 11,5
	Aluminium poli		

chaque colis 1 fauteuil

Optionals

Code	Description	Revêtement											colis	m ³	Kg			
		A	B	C	D	E	F	G	H	L1	L2	L3						
20ELE01	Coussin amovible Elephant (non déhoussable)												-	-	-	1	0,02	1
20LIR01	Coussin amovible LIPS-R (non déhoussable)			-	-	-	-	-	-	-	-	-	-	-	-	1	0,01	1
20LIS01	Coussin amovible LIPS-S (non déhoussable)			-	-	-	-	-	-	-	-	-	-	-	-	1	0,01	1

ELEPHANT (20ELE01)

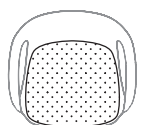

LIPS-R (20LIR01)



LIPS-S (20LIS01)

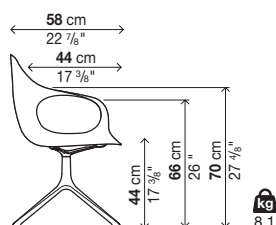
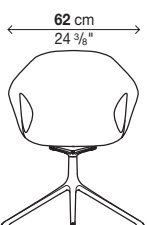
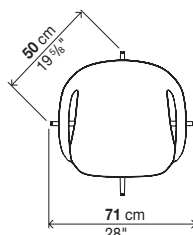

ELEPHANT

Tréteau pivotant - Coque revêtue en cuir (non déhoussable)

Finition piètement:

Aluminium poli

Aluminium laqué (dans les coloris du polyuréthane)

Finition du revêtement:

Cuir "Cuoietto" (C)

Cuir "Pleine fleur" (PF) naturel ou noir

Notes:

Attention: les dimensions et les finitions marquées par un point d'exclamation (!) ont des délais de production plus longs (environ 6 semaines à partir de la date de la commande).

Pour couleur couture et bord voir "règles cuir" intérieur de la couverture.

PIEDS:

Standard en feutre pour sols en bois.

Emballages renforcés, voir intérieur de la couverture.

Code	Piètement	Revêtement		colis	m ³	Kg
		Cuir "Cuoietto" (C) (!)	Cuir "pleine fleur" (PF) (!)			
05ELE71	Aluminium laqué			1	0,38	14
	Aluminium poli					

chaque colis 1 fauteuil

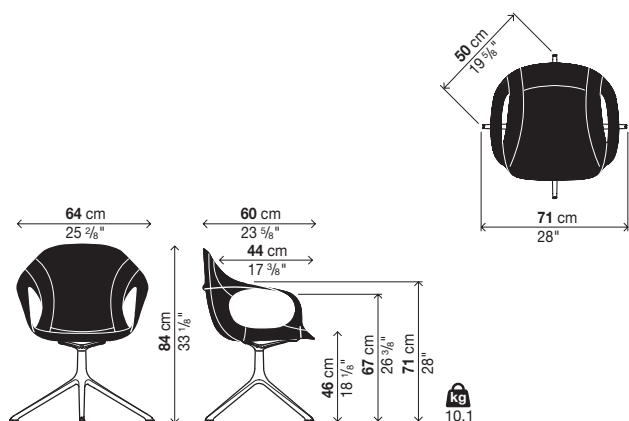

ELEPHANT

Tréteau pivotant - Coque revêtue en tissu (non déhoussable)

Finition piètement:

Aluminium poli

Aluminium laqué (dans les coloris du polyuréthane)

Finition du revêtement:

B = COM (tissu Client)

D = Remix 2

E = Canvas 2, Hero, Melange Nap

F = Regal, Steelcut Trio 3

G = Divina Melange 3, Hallingdal 65

H = Twill Weave

Notes:

Pour les commandes COM, voir intérieur de la couverture.

Pour toute information sur les compositions des tissus, voir intérieur de la couverture.

PIEDS:

Standard en feutre pour sols en bois.

Consommation COM: 1,5 ml (H. 140 cm).

Emballages renforcés, voir intérieur de la couverture.

Code	Piètement	Revêtement											colis m ² Kg	
		A	B	C	D	E	F	G	H	L1	L2	L3		
05ELE54	Aluminium laqué	-		-							-	-	-	1 0,38 13,5
	Aluminium poli	-		-							-	-	-	

chaque colis 1 fauteuil

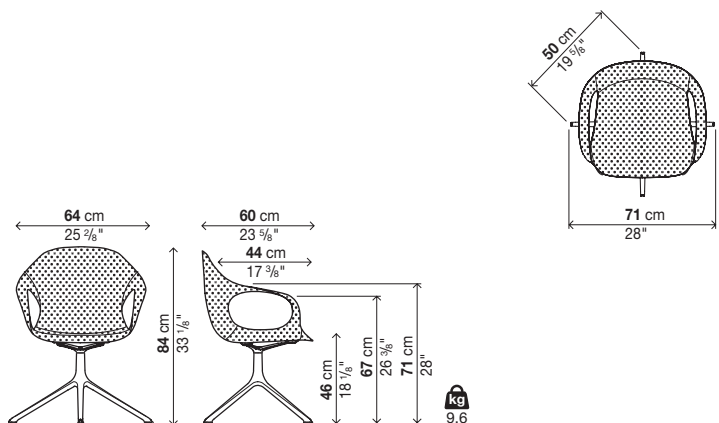

ELEPHANT

Cinq branches avec roulettes - Coque en polyuréthane

Finition piètement:

Aluminium poli
Aluminium laqué (blanc, noir)

Finition coque:

Polyuréthane blanc (P001)
Polyuréthane noir (P003)
Polyuréthane beige (P004)
Polyuréthane terre cuite (P006)
Polyuréthane vert olive (P008)
Polyuréthane rouge rubis (P010)
Polyuréthane gris Londres (P011)
Polyuréthane bleu poussière (P012)

Finition revêtement coussin Elephant:

A = Valencia (cuir synthétique), COM (tissu Client)
B = Field 2
C = Clara 2, Merit
D = Curmi, Patio, Remix 2
E = Canvas 2, Hero, Melange Nap
F = Regal, Scuba, Steelcut Trio 3
G = Divina Melange 3, Hallingdal 65
H = Twill Weave

Finition revêtement coussin Lips:

A = COM (tissu Client)
B = Field 2

Notes:

Pour les commandes COM, voir intérieur de la couverture.

Pour toute information sur les compositions des tissus, voir intérieur de la couverture.

Roulettes pivotantes à frein avec bandage souple.

INFORMATIONS SUR L'EXPÉDITION DÉMONTÉES:

Pour des commandes de plus de 8 articles, les chaises seront livrées démontées. (seulement pour fauteuils avec coque en polyuréthane).

- 4 coques = 1 colis - Kg 19 / m³ 0,41
- 1 piètements = 1 colis - Kg 15 / m³ 0,14

Consommation coussin Elephant: 0,55 ml (H. 140 cm).

Consommation coussin Lips: 0,5 ml (H. 140 cm).

Emballages renforcés, voir intérieur de la couverture.

Code	Piètement	Coque	
		colis	m ³ Kg
		Polyuréthane	
05ELE41	Aluminium laqué	1	0,38 13
	Aluminium poli		

chaque colis 1 fauteuil

Optionals

Code	Description	Revêtement											colis	m ³	Kg		
		A	B	C	D	E	F	G	H	L1	L2	L3					
20ELE01	Coussin amovible Elephant (non déhoussable)											-	-	-	1	0,02	1
20LIR01	Coussin amovible LIPS-R (non déhoussable)			-	-	-	-	-	-	-	-	-	-	-	1	0,01	1
20LIS01	Coussin amovible LIPS-S (non déhoussable)			-	-	-	-	-	-	-	-	-	-	-	1	0,01	1

ELEPHANT (20ELE01)

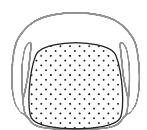

LIPS-R (20LIR01)

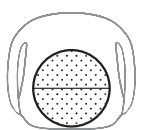

LIPS-S (20LIS01)

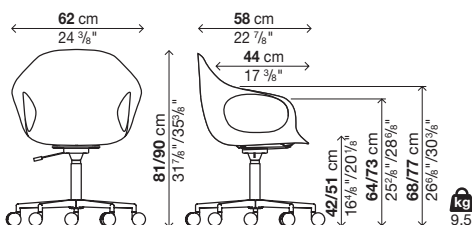
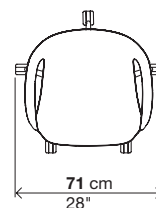

ELEPHANT

Cinq branches avec roulettes - Coque revêtue en cuir (non déhoussable)

Finition piètement:

Aluminium poli
Aluminium laqué (blanc, noir)

Finition du revêtement:

Cuir "Cuoietto" (C)
Cuir "Pleine fleur" (PF) naturel ou noir

Notes:

Attention: les dimensions et les finitions marquées par un point d'exclamation (!) ont des délais de production plus longs (environ 6 semaines à partir de la date de la commande).

Pour couleur couture et bord voir "règles cuir" intérieur de la couverture.

Roulettes pivotantes à frein avec bandage souple.

Emballages renforcés, voir intérieur de la couverture.

Code	Piètement	Revêtement		colis	m ³	Kg
		Cuir "Cuoietto" (C) (!)	Cuir "pleine fleur" (PF) (!)			
05ELE42	Aluminium laqué			1	0,38	15,5
	Aluminium poli					

chaque colis 1 fauteuil

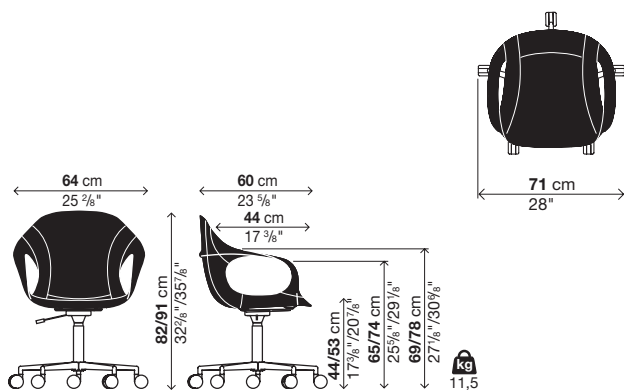

ELEPHANT

Cinq branches avec roulettes - Coque revêtue en tissu (non déhoussable)

Finition piètement:

Aluminium poli
Aluminium laqué (blanc, noir)

Finition du revêtement:

B = COM (tissu Client)
D = Remix 2
E = Canvas 2, Hero, Melange Nap
F = Regal, Steelcut Trio 3
G = Divina Melange 3, Hallingdal 65
H = Twill Weave

Notes:

Pour les commandes COM, voir intérieur de la couverture.

Pour toute information sur les compositions des tissus, voir intérieur de la couverture.

Roulettes pivotantes à frein avec bandage souple.

Consommation COM: 1,5 ml (H. 140 cm).

Emballages renforcés, voir intérieur de la couverture.

Code	Piètement	Revêtement										colis	m ²	Kg		
		A	B	C	D	E	F	G	H	L1	L2				L3	
05ELE43	Aluminium laqué	-		-							-	-	-	1	0,38	15
	Aluminium poli	-		-							-	-	-			

chaque colis 1 fauteuil

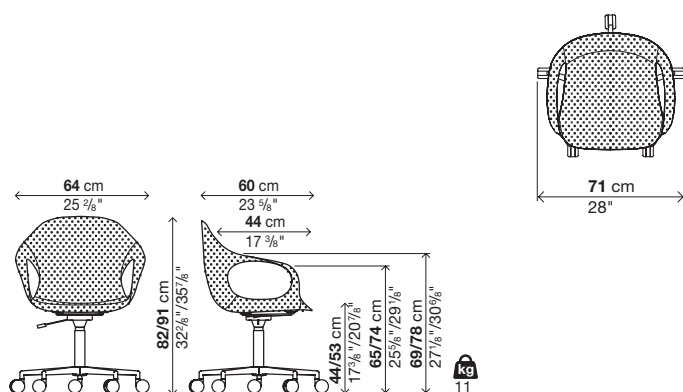

ELEPHANT

Fauteuil lounge - Coque en polyuréthane

Finition piètement:

Acier chromé
Acier chromé noir
Acier aspect laiton
Acier laqué (dans les coloris du polyuréthane)

Finition coque:

Polyuréthane blanc (P001)
Polyuréthane noir (P003)
Polyuréthane beige (P004)
Polyuréthane terre cuite (P006)
Polyuréthane vert olive (P008)
Polyuréthane rouge rubis (P010)
Polyuréthane gris Londres (P011)
Polyuréthane bleu poussière (P012)

Finition revêtement coussin Elephant:

A = Valencia (cuir synthétique), COM (tissu Client)
B = Field 2
C = Clara 2, Merit
D = Curmi, Patio, Remix 2
E = Canvas 2, Hero, Melange Nap
F = Regal, Scuba, Steelcut Trio 3
G = Divina Melange 3, Hallingdal 65
H = Twill Weave

Finition revêtement coussin Lips:

A = COM (tissu Client)
B = Field 2

Notes:

Pour les commandes COM, voir intérieur de la couverture.

Pour toute information sur les compositions des tissus, voir intérieur de la couverture.

PIEDS:

Standard en plastique dur. Sur demande, nous fournissons des pieds avec insert en feutre pour sols en bois.

INFORMATIONS SUR L'EXPÉDITION DÉMONTÉES:

Pour des commandes de plus de 8 articles, les chaises seront livrées démontées. (seulement pour fauteuils avec coque en polyuréthane).
- 4 coques = 1 colis - Kg 19 / m³ 0,41
- 4 piètements = 1 colis - Kg 14 / m³ 0,28

Consommation coussin Elephant: 0,55 ml (H. 140 cm).

Consommation coussin Lips: 0,5 ml (H. 140 cm).

Emballages renforcés, voir intérieur de la couverture.

Code	Piètement	Coque	
		colis	m ³ Kg
		Polyuréthane	
05ELE03	Acier laqué, Acier chromé, Acier chromé noir	1	0,4 10
	Acier aspect laiton		

chaque colis 1 fauteuil

Optionals

Code	Description	Revêtement											colis	m ³	Kg	
		A	B	C	D	E	F	G	H	L1	L2	L3				
20ELE01	Coussin amovible Elephant (non déhoussable)										-	-	-	1	0,02	1
20LIR01	Coussin amovible LIPS-R (non déhoussable)			-	-	-	-	-	-	-	-	-	-	1	0,01	1
20LIS01	Coussin amovible LIPS-S (non déhoussable)			-	-	-	-	-	-	-	-	-	-	1	0,01	1
02PIE14	Lot de patins en feutre													-	-	-

ELEPHANT (20ELE01)

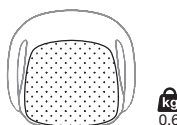

kg
0,6

LIPS-R (20LIR01)

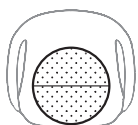

kg
0,6

LIPS-S (20LIS01)

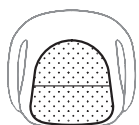

kg
0,6

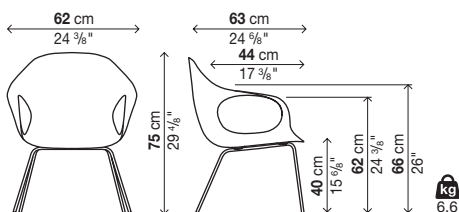

ELEPHANT

Fauteuil lounge - Coque revêtue en cuir (non déhoussable)

Finition piètement:

Acier chromé
 Acier chromé noir
 Acier aspect laiton
 Acier laqué (dans les coloris du polyuréthane)

Finition du revêtement:

Cuir "Cuoietto" (C)
 Cuir "Pleine fleur" (PF) naturel ou noir

Notes:

Attention: les dimensions et les finitions marquées par un point d'exclamation (!) ont des délais de production plus longs (environ 6 semaines à partir de la date de la commande).

Pour couleur couture et bord voir "règles cuir" intérieur de la couverture.

Emballages renforcés, voir intérieur de la couverture.

Code	Piètement	Revêtement		colis	m ²	Kg
		Cuir "Cuoietto" (C) (!)	Cuir "pleine fleur" (PF) (!)			
05ELE13	Acier laqué, Acier chromé, Acier chromé noir			1	0,4	11,5
	Acier aspect laiton					

chaque colis 1 fauteuil

Optionals

Code	Description	colis	m ²	Kg
02PIE14	Lot de patins en feutre	-	-	-

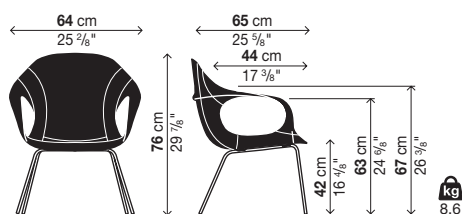

ELEPHANT

Fauteuil lounge - Coque revêtue en tissu (non déhoussable)

Finition piètement:

Acier chromé
 Acier chromé noir
 Acier aspect laiton
 Acier laqué (dans les coloris du polyuréthane)

Finition du revêtement:

B = COM (tissu Client)
 D = Remix 2
 E = Canvas 2, Hero, Melange Nap
 F = Regal, Steelcut Trio 3
 G = Divina Melange 3, Hallingdal 65
 H = Twill Weave

Notes:

Pour les commandes COM, voir intérieur de la couverture.

Pour toute information sur les compositions des tissus, voir intérieur de la couverture.

PIEDS:

Standard en plastique dur. Sur demande, nous fournissons des pieds avec insert en feutre pour sols en bois.

Consommation COM: 1,5 ml (H. 140 cm).

Emballages renforcés, voir intérieur de la couverture.

Code	Piètement	Revêtement											colis	m ³	Kg	
		A	B	C	D	E	F	G	H	L1	L2	L3				
05ELE23	Acier laqué, Acier chromé, Acier chromé noir	-		-							-	-	-	1	0,4	11
	Acier aspect laiton	-		-							-	-	-			

chaque colis 1 fauteuil

Optionals

Code	Description	colis	m ³	Kg
02PIE14	Lot de patins en feutre	-	-	-

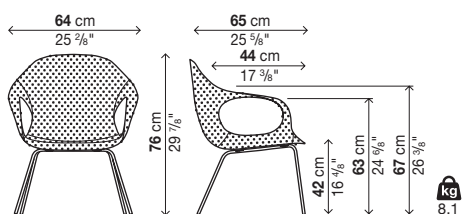

ELEPHANT

Leyenda

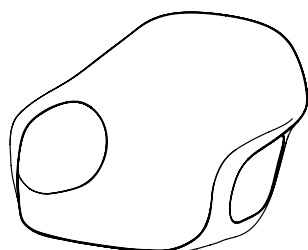
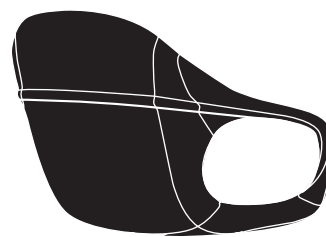

Bastidor de poliuretano

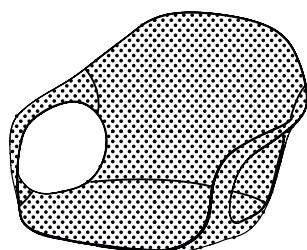

Bastidor revestido en tejido

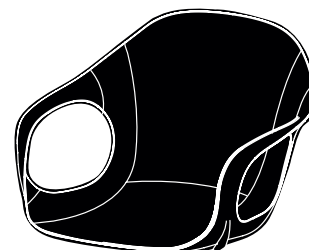

Bastidor revestido en cuero



Cuatro patas

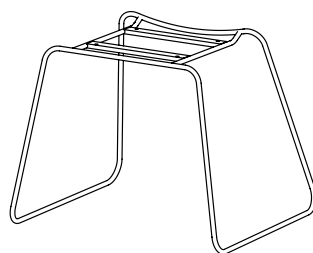

Trineo

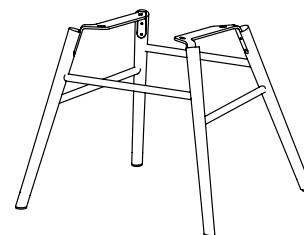

Base de madera

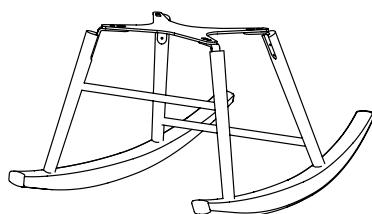

Rocking

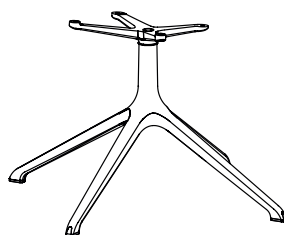

Trípode giratoria

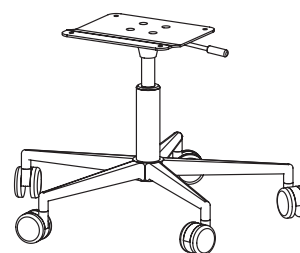

Cinco radios

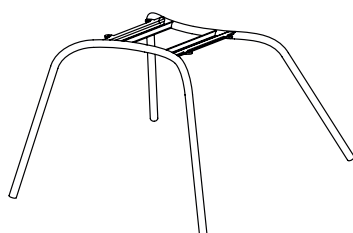

Lounge

ELEPHANT

Cuatro patas - Bastidor de poliuretano

Acabado base:

Acero cromado
Acero cromado negro
Acero cromado satinado
Acero efecto latón
Acero barnizado (en los colores del poliuretano)

Acabado asiento:

Poliuretano blanco (P001)
Poliuretano negro (P003)
Poliuretano beige (P004)
Poliuretano terracota (P006)
Poliuretano verde oliva (P008)
Poliuretano rojo rubí (P010)
Poliuretano gris Londres (P011)
Poliuretano azul polvo (P012)

Acabado revestimiento cojín Elephant:

A = Valencia (piel sintética), COM (tejido Cliente)
B = Field 2
C = Clara 2, Merit
D = Curmi, Patio, Remix 2
E = Canvas 2, Hero, Melange Nap
F = Regal, Scuba, Steelcut Trio 3
G = Divina Melange 3, Hallingdal 65
H = Twill Weave

Acabado revestimiento cojín Lips:

A = COM (tejido Cliente)
B = Field 2

Notas:

Para pedidos COM ver lado interno de la portada.

Para obtener información sobre las composiciones de los tejidos, ver lado interno de la portada.

PATAS:

Estánder en plástico duro. Bajo pedido se suministran pies con inserto de fieltro para pisos de madera.

INFORMACIÓN DE ENVÍO DESMONTABLE:

Para pedidos de más de 8 unidades, el producto se entrega desmontado (solo para sillas con asiento en poliuretano).
- 4 asientos = 1 pack - Kg 19 / m³ 0,41.
- 4 bases = 1 pack - Kg 14 / m³ 0,26.

Consumo cojín Elephant: 0,55 ml (H. 140 cm).

Consumo cojín Lips: 0,5 ml (H. 140 cm).

Embalajes reforzados, ver lado interno de la portada.

Código	Base	Asiento		
		pack	m ³	Kg
		Poliuretano		
05ELE11	Acero barnizado, Acero cromado, Acero cromado negro	1	0,4	10
	Acero efecto latón, Acero satinado			

cada paquete contiene 1 butaca

Opcionales

Código	Descripción	Revestimiento											pack	m ³	Kg			
		A	B	C	D	E	F	G	H	L1	L2	L3						
20ELE01	Cojín extraíble Elephant (no desenfundable)												-	-	-	1	0,02	1
20LIR01	Cojín extraíble LIPS-R (no desenfundable)			-	-	-	-	-	-	-	-	-	-	-	-	1	0,01	1
20LIS01	Cojín extraíble LIPS-S (no desenfundable)			-	-	-	-	-	-	-	-	-	-	-	-	1	0,01	1
02PIE03	Juego de almohadillas de fieltro															-	-	-

ELEPHANT (20ELE01)

LIPS-R (20LIR01)

LIPS-S (20LIS01)

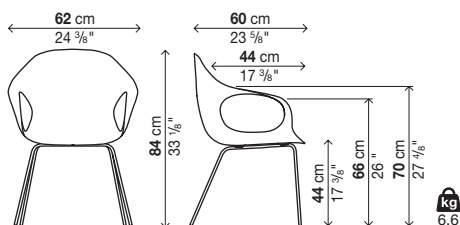

ELEPHANT

Cuatro patas - Bastidor revestido en cuero (no desenfundable)

Acabado base:

Acero cromado
 Acero cromado negro
 Acero cromado satinado
 Acero efecto latón
 Acero barnizado (en los colores del poliuretano)

Acabado revestimiento:

Segundo corte a cuero (C)
 Cuero "plena flor" (PF) natural o negro

Notas:

Atención: las medidas o los acabados marcados con (!) tienen los tiempos de producción más largos, de aproximadamente 6 semanas desde la fecha del pedido.

Para colores costuras y bordes ver "reglas cuero" lado interno de la portada.

PATAS:

Estánder en plástico duro. Bajo pedido se suministran pies con inserto de fieltro para pisos de madera.

Embalajes reforzados, ver lado interno de la portada.

Código	Base	Revestimiento		pack	m ²	Kg
		Segundo corte a cuero (C) (!)	Cuero "plena flor" (PF) (!)			
05ELE01	Acero barnizado, Acero cromado, Acero cromado negro			1	0,4	11,5
	Acero efecto latón, Acero satinado					

cada paquete contiene 1 butaca

Opcionales

Código	Descripción	pack	m ²	Kg
02PIE03	Juego de almohadillas de fieltro	-	-	-

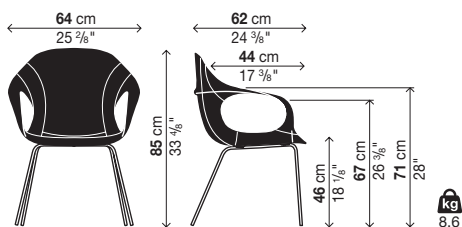

ELEPHANT

Cuatro patas - Bastidor revestido en tejido (no desenfundable)

Acabado base:

Acero cromado
 Acero cromado negro
 Acero cromado satinado
 Acero efecto latón
 Acero barnizado (en los colores del poliuretano)

Acabado revestimiento:

B = COM (tejido Cliente)
 D = Remix 2
 E = Canvas 2, Hero, Melange Nap
 F = Regal, Steelcut Trio 3
 G = Divina Melange 3, Hallingdal 65
 H = Twill Weave

Notas:

Para pedidos COM ver lado interno de la portada.

Para obtener información sobre las composiciones de los tejidos, ver lado interno de la portada.

PATAS:

Estándar en plástico duro. Bajo pedido se suministran pies con inserto de fieltro para pisos de madera.

Consumo COM: 1,5 ml (H. 140 cm).

Embalajes reforzados, ver lado interno de la portada.

Código	Base	Revestimiento											pack	m ²	Kg	
		A	B	C	D	E	F	G	H	L1	L2	L3				
05ELE51	Acero barnizado, Acero cromado, Acero cromado negro	-		-							-	-	-	1	0,4	11
	Acero efecto latón, Acero satinado	-		-							-	-	-			

cada paquete contiene 1 butaca

Opcionales

Código	Descripción	pack	m ²	Kg
02PIE03	Juego de almohadillas de fieltro	-	-	-

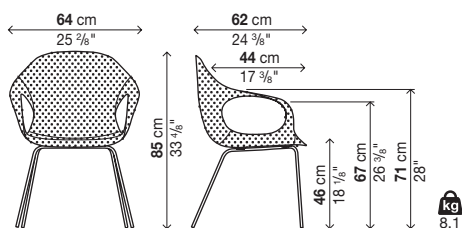

ELEPHANT

Trineo - Bastidor de poliuretano

Acabado base:

Acero cromado
Acero cromado negro
Acero cromado satinado
Acero efecto latón
Acero barnizado (en los colores del poliuretano)

Acabado asiento:

Poliuretano blanco (P001)
Poliuretano negro (P003)
Poliuretano beige (P004)
Poliuretano terracota (P006)
Poliuretano verde oliva (P008)
Poliuretano rojo rubí (P010)
Poliuretano gris Londres (P011)
Poliuretano azul polvo (P012)

Acabado revestimiento cojín Elephant:

A = Valencia (piel sintética), COM (tejido Cliente)
B = Field 2
C = Clara 2, Merit
D = Curmi, Patio, Remix 2
E = Canvas 2, Hero, Melange Nap
F = Regal, Scuba, Steelcut Trio 3
G = Divina Melange 3, Hallingdal 65
H = Twill Weave

Acabado revestimiento cojín Lips:

A = COM (tejido Cliente)
B = Field 2

Notas:

Para pedidos COM ver lado interno de la portada.

Para obtener información sobre las composiciones de los tejidos, ver lado interno de la portada.

PATAS:

Estándar en plástico duro. Bajo pedido se suministran pies con inserto de fieltro para pisos de madera.

INFORMACIÓN DE ENVÍO DESMONTABLE:

Para pedidos de más de 8 unidades, el producto se entrega desmontado (solo para sillas con asiento en poliuretano).
- 4 asientos = 1 pack - Kg 19 / m³ 0,41
- 4 bases = 1 pack - Kg 19 / m³ 0,26

Consumo cojín Elephant: 0,55 ml (H. 140 cm).

Consumo cojín Lips: 0,5 ml (H. 140 cm).

Embalajes reforzados, ver lado interno de la portada.

Código	Base	Asiento	
		pack	m ³ Kg
		Poliuretano	
05ELE12	Acero barnizado, Acero cromado, Acero cromado negro	1	0,4 11,2
	Acero efecto latón, Acero satinado		

cada paquete contiene 1 butaca

Opcionales

Código	Descripción	Revestimiento										pack	m ³	Kg		
		A	B	C	D	E	F	G	H	L1	L2				L3	
20ELE01	Cojín extraíble Elephant (no desenfundable)										-	-	-	1	0,02	1
20LIR01	Cojín extraíble LIPS-R (no desenfundable)			-	-	-	-	-	-	-	-	-	-	1	0,01	1
20LIS01	Cojín extraíble LIPS-S (no desenfundable)			-	-	-	-	-	-	-	-	-	-	1	0,01	1
02PIE03	Juego de almohadillas de fieltro													-	-	-

ELEPHANT (20ELE01)

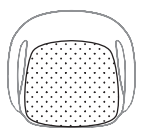

LIPS-R (20LIR01)

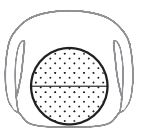

LIPS-S (20LIS01)

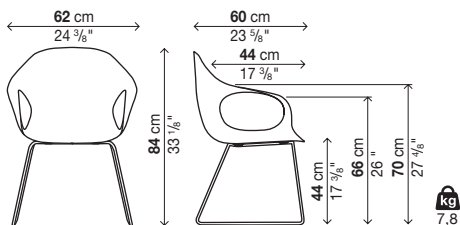
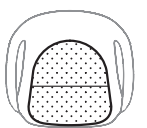

ELEPHANT

Trineo - Bastidor revestido en cuero (no desenfundable)

Acabado base:

Acero cromado
 Acero cromado negro
 Acero cromado satinado
 Acero efecto latón
 Acero barnizado (en los colores del poliuretano)

Acabado revestimiento:

Segundo corte a cuero (C)
 Cuero "plena flor" (PF) natural o negro

Notas:

Atención: las medidas o los acabados marcados con (!) tienen los tiempos de producción más largos, de aproximadamente 6 semanas desde la fecha del pedido.

Para colores costuras y bordes ver "reglas cuero" lado interno de la portada.

PATAS:

Estándar en plástico duro. Bajo pedido se suministran pies con inserto de fieltro para pisos de madera.

Embalajes reforzados, ver lado interno de la portada.

Código	Base	Revestimiento		pack	m ²	Kg
		Segundo corte a cuero (C) (!)	Cuero "plena flor" (PF) (!)			
05ELE02	Acero barnizado, Acero cromado, Acero cromado negro			1	0,4	13
	Acero efecto latón, Acero satinado					

cada paquete contiene 1 butaca

Opcionales

Código	Descripción	pack	m ²	Kg
02PIE03	Juego de almohadillas de fieltro	-	-	-

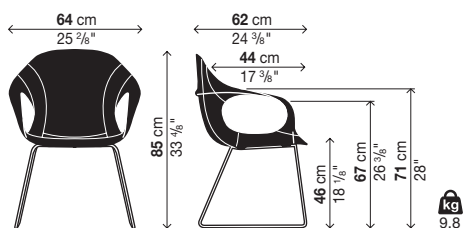

ELEPHANT

Trineo - Bastidor revestido en tejido (no desenfundable)

Acabado base:

Acero cromado
 Acero cromado negro
 Acero cromado satinado
 Acero efecto latón
 Acero barnizado (en los colores del poliuretano)

Acabado revestimiento:

B = COM (tejido Cliente)
 D = Remix 2
 E = Canvas 2, Hero, Melange Nap
 F = Regal, Steelcut Trio 3
 G = Divina Melange 3, Hallingdal 65
 H = Twill Weave

Notas:

Para pedidos COM ver lado interno de la portada.

Para obtener información sobre las composiciones de los tejidos, ver lado interno de la portada.

PATAS:

Estándar en plástico duro. Bajo pedido se suministran pies con inserto de fieltro para pisos de madera.

Consumo COM: 1,5 ml (H. 140 cm).

Embalajes reforzados, ver lado interno de la portada.

Código	Base	Revestimiento										pack	m ²	Kg		
		A	B	C	D	E	F	G	H	L1	L2				L3	
05ELE52	Acero barnizado, Acero cromado, Acero cromado negro	-		-							-	-	-	1	0,4	12,5
	Acero efecto latón, Acero satinado	-		-							-	-	-			

cada paquete contiene 1 butaca

Opcionales

Código	Descripción	pack	m ²	Kg
02PIE04	Juego de almohadillas de fieltro	-	-	-

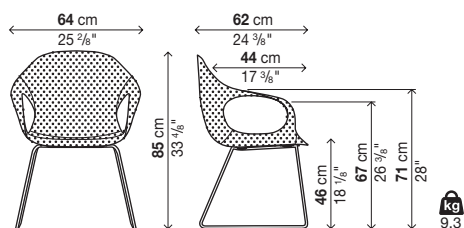

ELEPHANT

Base de madera - Bastidor de poliuretano

Acabado base:

Madera maciza de haya
Madera maciza de roble europeo
Madera maciza de roble teñido nogal
Madera maciza barnizada (en los colores del poliuretano)

Acabado asiento:

Poliuretano blanco (P001)
Poliuretano negro (P003)
Poliuretano beige (P004)
Poliuretano terracota (P006)
Poliuretano verde oliva (P008)
Poliuretano rojo rubí (P010)
Poliuretano gris Londres (P011)
Poliuretano azul polvo (P012)

Acabado revestimiento cojín Elephant:

A = Valencia (piel sintética), COM (tejido Cliente)
B = Field 2
C = Clara 2, Merit
D = Curmi, Patio, Remix 2
E = Canvas 2, Hero, Melange Nap
F = Regal, Scuba, Steelcut Trio 3
G = Divina Melange 3, Hallingdal 65
H = Twill Weave

Acabado revestimiento cojín Lips:

A = COM (tejido Cliente)
B = Field 2

Notas:

Para pedidos COM ver lado interno de la portada.

Para obtener información sobre las composiciones de los tejidos, ver lado interno de la portada.

PATAS:

Estándar en plástico duro. Bajo pedido se suministran pies con inserto de fieltro para pisos de madera.

INFORMACIÓN DE ENVÍO DESMONTABLE:

Para pedidos de más de 8 unidades, el producto se entrega desmontado (solo para sillas con asiento en poliuretano).
- 4 asientos = 1 pack - Kg 19 / m³ 0,41
- 4 bases = 1 pack - Kg 12 / m³ 0,33

Consumo cojín Elephant: 0,55 ml (H. 140 cm).

Consumo cojín Lips: 0,5 ml (H. 140 cm).

Embalajes reforzados, ver lado interno de la portada.

Código	Base	Asiento		
		Asiento	pack	m ³ Kg
		Poliuretano		
05ELE82	Haya			
	Roble europeo, Roble tenido nogal, Madera barnizada		1	0,4 9,3

cada paquete contiene 1 butaca

Opcionales

Código	Descripción	Revestimiento											pack	m ³	Kg	
		A	B	C	D	E	F	G	H	L1	L2	L3				
20ELE01	Cojín extraíble Elephant (no desenfundable)										-	-	-	1	0,02	1
20LIR01	Cojín extraíble LIPS-R (no desenfundable)			-	-	-	-	-	-	-	-	-	-	1	0,01	1
20LIS01	Cojín extraíble LIPS-S (no desenfundable)			-	-	-	-	-	-	-	-	-	-	1	0,01	1
02PIE05	Juego de almohadillas de fieltro															

ELEPHANT (20ELE01)

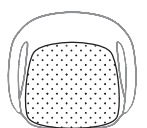

LIPS-R (20LIR01)

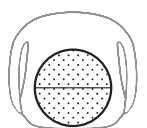

LIPS-S (20LIS01)

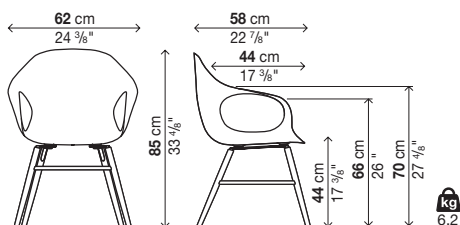
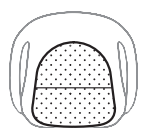

ELEPHANT

Base de madera - Bastidor revestido en cuero (no desenfundable)

Acabado base:

Madera maciza de haya
Madera maciza de roble europeo
Madera maciza de roble teñido nogal
Madera maciza barnizada (en los colores del poliuretano)

Acabado revestimiento:

Segundo corte a cuero (C)
Cuero "plena flor" (PF) natural o negro

Notas:

Atención: las medidas o los acabados marcados con (!) tienen los tiempos de producción más largos, de aproximadamente 6 semanas desde la fecha del pedido.

Para colores costuras y bordes ver "reglas cuero" lado interno de la portada.

PATAS:

Estándar en plástico duro. Bajo pedido se suministran pies con inserto de fieltro para pisos de madera.

Embalajes reforzados, ver lado interno de la portada.

Código	Base	Revestimiento		pack	m ²	Kg
		Segundo corte a cuero (C) (!)	Cuero "plena flor" (PF) (!)			
05ELE81	Haya			1	0,38	11,2
	Roble europeo, Roble tenido nogal, Madera barnizada					

cada paquete contiene 1 butaca

Opcionales

Código	Descripción	pack	m ²	Kg
02PIE05	Juego de almohadillas de fieltro	-	-	-

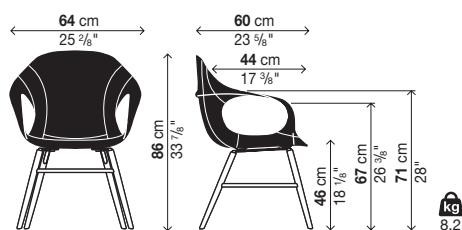

ELEPHANT

Base de madera - Bastidor revestido en tejido (no desenfundable)

Acabado base:

Madera maciza de haya
Madera maciza de roble europeo
Madera maciza de roble teñido nogal
Madera maciza barnizada (en los colores del poliuretano)

Acabado revestimiento:

B = COM (tejido Cliente)
D = Remix 2
E = Canvas 2, Hero, Melange Nap
F = Regal, Steelcut Trio 3
G = Divina Melange 3, Hallingdal 65
H = Twill Weave

Notas:

Para pedidos COM ver lado interno de la portada.

Para obtener información sobre las composiciones de los tejidos, ver lado interno de la portada.

PATAS:

Estándar en plástico duro. Bajo pedido se suministran pies con inserto de fieltro para pisos de madera.

Consumo COM: 1,5 ml (H. 140 cm).

Embalajes reforzados, ver lado interno de la portada.

Código	Base	Revestimiento											pack	m ³	Kg	
		A	B	C	D	E	F	G	H	L1	L2	L3				
05ELE53	Haya	-		-							-	-	-	1	0,4	10,7
	Roble europeo, Roble tenido nogal, Madera barnizada	-		-							-	-	-			

cada paquete contiene 1 butaca

Opcionales

Código	Descripción	pack	m ³	Kg
02PIE05	Juego de almohadillas de fieltro	-	-	-

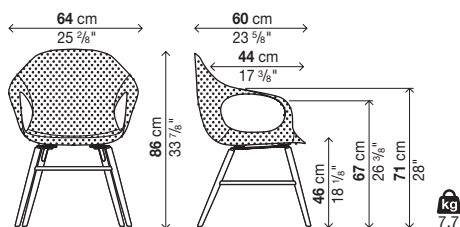

ELEPHANT

Rocking - Bastidor de poliuretano

Acabado base:

Madera maciza de haya
Madera maciza de roble europeo
Madera maciza de roble teñido nogal
Madera maciza barnizada (en los colores del poliuretano)

Acabado asiento:

Poliuretano blanco (P001)
Poliuretano negro (P003)
Poliuretano beige (P004)
Poliuretano terracota (P006)
Poliuretano verde oliva (P008)
Poliuretano rojo rubí (P010)
Poliuretano gris Londres (P011)
Poliuretano azul polvo (P012)

Acabado revestimiento cojín Elephant:

A = Valencia (piel sintética), COM (tejido Cliente)
B = Field 2
C = Clara 2, Merit
D = Curmi, Patio, Remix 2
E = Canvas 2, Hero, Melange Nap
F = Regal, Scuba, Steelcut Trio 3
G = Divina Melange 3, Hallingdal 65
H = Twill Weave

Acabado revestimiento cojín Lips:

A = COM (tejido Cliente)
B = Field 2

Notas:

Para pedidos COM ver lado interno de la portada.

Para obtener información sobre las composiciones de los tejidos, ver lado interno de la portada.

INFORMACIÓN DE ENVÍO DESMONTABLE:

Para pedidos de más de 8 unidades, el producto se entrega desmontado (solo para sillas con asiento en poliuretano).
- 4 asientos = 1 pack - Kg 19 / m³ 0,41
- 2 bases = 1 pack - Kg 10 / m³ 0,34

Consumo cojín Elephant: 0,55 ml (H. 140 cm).

Consumo cojín Lips: 0,5 ml (H. 140 cm).

Embalajes reforzados, ver lado interno de la portada.

Código	Base	Asiento		
		pack	m ³	Kg
		Poliuretano		
05ELE91	Haya			
	Roble europeo, Roble tenido nogal, Madera barnizada	1	0,56	12

cada paquete contiene 1 butaca

Opcionales

Código	Descripción	Revestimiento										pack	m ³	Kg		
		A	B	C	D	E	F	G	H	L1	L2				L3	
20ELE01	Cojín extraíble Elephant (no desenfundable)										-	-	-	1	0,02	1
20LIR01	Cojín extraíble LIPS-R (no desenfundable)			-	-	-	-	-	-	-	-	-	-	1	0,01	1
20LIS01	Cojín extraíble LIPS-S (no desenfundable)			-	-	-	-	-	-	-	-	-	-	1	0,01	1

ELEPHANT (20ELE01)

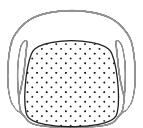

kg
0,6

LIPS-R (20LIR01)

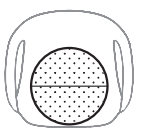

kg
0,6

LIPS-S (20LIS01)



kg
0,6

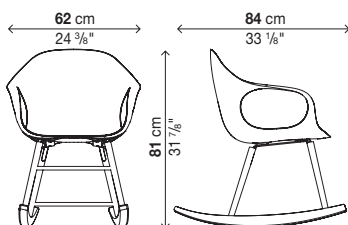

ELEPHANT

Rocking - Bastidor revestido en cuero (no desenfundable)

Acabado base:

Madera maciza de haya
Madera maciza de roble europeo
Madera maciza de roble teñido nogal
Madera maciza barnizada (en los colores del poliuretano)

Acabado revestimiento:

Segundo corte a cuero (C)
Cuero "plena flor" (PF) natural o negro

Notas:

Atención: las medidas o los acabados marcados con (!) tienen los tiempos de producción más largos, de aproximadamente 6 semanas desde la fecha del pedido.

Para colores costuras y bordes ver "reglas cuero" lado interno de la portada.

Embalajes reforzados, ver lado interno de la portada.

Código	Base	Revestimiento		pack	m ³	Kg
		Segundo corte a cuero (C) (!)	Cuero "plena flor" (PF) (!)			
05ELE92	Haya			1	0,56	14
	Roble europeo, Roble tenido nogal, Madera barnizada					

cada paquete contiene 1 butaca

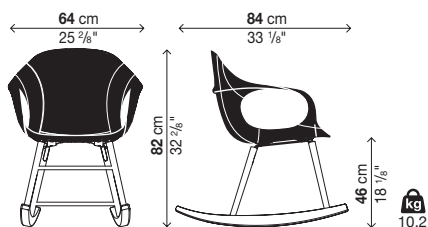

ELEPHANT

Rocking - Bastidor revestido en tejido (no desenfundable)

Acabado base:

Madera maciza de haya
 Madera maciza de roble europeo
 Madera maciza de roble teñido nogal
 Madera maciza barnizada (en los colores del poliuretano)

Acabado revestimiento:

B = COM (tejido Cliente)
 D = Remix 2
 E = Canvas 2, Hero, Melange Nap
 F = Regal, Steelcut Trio 3
 G = Divina Melange 3, Hallingdal 65
 H = Twill Weave

Notas:

Para pedidos COM ver lado interno de la portada.

Para obtener información sobre las composiciones de los tejidos, ver lado interno de la portada.

Consumo COM: 1,5 ml (H. 140 cm).

Embalajes reforzados, ver lado interno de la portada.

Código	Base	Revestimiento											pack	m ²	Kg
		A	B	C	D	E	F	G	H	L1	L2	L3			
05ELE93	Haya	-		-						-	-	-	1	0,56	13,5
	Roble europeo, Roble tenido nogal, Madera barnizada	-		-						-	-	-			

cada paquete contiene 1 butaca

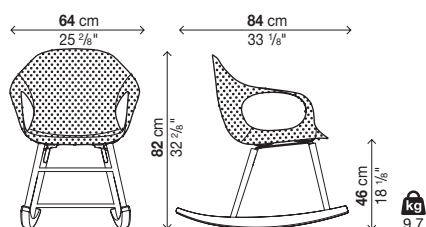

ELEPHANT

Trípode giratoria - Bastidor de poliuretano

Acabado base:

Aluminio pulido

Aluminio barnizado (en los colores del poliuretano)

Acabado asiento:

Poliuretano blanco (P001)

Poliuretano negro (P003)

Poliuretano beige (P004)

Poliuretano terracota (P006)

Poliuretano verde oliva (P008)

Poliuretano rojo rubí (P010)

Poliuretano gris Londres (P011)

Poliuretano azul polvo (P012)

Acabado revestimiento cojín Elephant:

A = Valencia (piel sintética), COM (tejido Cliente)

B = Field 2

C = Clara 2, Merit

D = Curmi, Patio, Remix 2

E = Canvas 2, Hero, Melange Nap

F = Regal, Scuba, Steelcut Trio 3

G = Divina Melange 3, Hallingdal 65

H = Twill Weave

Acabado revestimiento cojín Lips:

A = COM (tejido Cliente)

B = Field 2

Notas:

Para pedidos COM ver lado interno de la portada.

Para obtener información sobre las composiciones de los tejidos, ver lado interno de la portada.

PATAS:

Estándar en fieltro para suelos de madera.

INFORMACIÓN DE ENVÍO DESMONTABLE:

Para pedidos de más de 8 unidades, el producto se entrega desmontado (solo para sillas con asiento en poliuretano).

- 4 asientos = 1 pack - Kg 19 / m³ 0,41

- 1 bases = 1 pack - Kg 6 / m³ 0,14

Consumo cojín Elephant: 0,55 ml (H. 140 cm).

Consumo cojín Lips: 0,5 ml (H. 140 cm).

Embalajes reforzados, ver lado interno de la portada.

Código	Base	Asiento	
		Poliuretano	pack m ³ Kg
05ELE72	Aluminio barnizado		1 0,38 11,5
	Aluminio pulido		

cada paquete contiene 1 butaca

Opcionales

Código	Descripción	Revestimiento											pack m ³ Kg	
		A	B	C	D	E	F	G	H	L1	L2	L3		
20ELE01	Cojín extraíble Elephant (no desenfundable)										-	-	-	1 0,02 1
20LIR01	Cojín extraíble LIPS-R (no desenfundable)			-	-	-	-	-	-	-	-	-	-	1 0,01 1
20LIS01	Cojín extraíble LIPS-S (no desenfundable)			-	-	-	-	-	-	-	-	-	-	1 0,01 1

ELEPHANT (20ELE01)

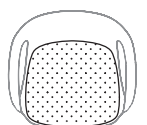

LIPS-R (20LIR01)

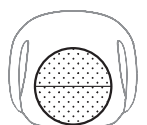

LIPS-S (20LIS01)

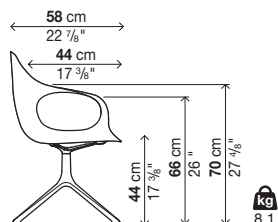
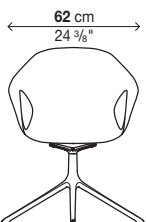
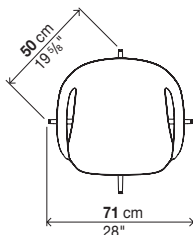
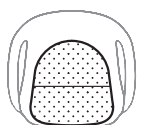

ELEPHANT

Trípode giratoria - Bastidor revestido en cuero (no desenfundable)

Acabado base:

Aluminio pulido

Aluminio barnizado (en los colores del poliuretano)

Acabado revestimiento:

Segundo corte a cuero (C)

Cuero "plena flor" (PF) natural o negro

Notas:

Atención: las medidas o los acabados marcados con (!) tienen los tiempos de producción más largos, de aproximadamente 6 semanas desde la fecha del pedido.

Para colores costuras y bordes ver "reglas cuero" lado interno de la portada.

PATAS:

Estándar en fieltro para suelos de madera.

Embalajes reforzados, ver lado interno de la portada.

Código	Base	Revestimiento		pack	m ³	Kg
		Segundo corte a cuero (C) (!)	Cuero "plena flor" (PF) (!)			
05ELE71	Aluminio barnizado			1	0,38	14
	Aluminio pulido					

cada paquete contiene 1 butaca

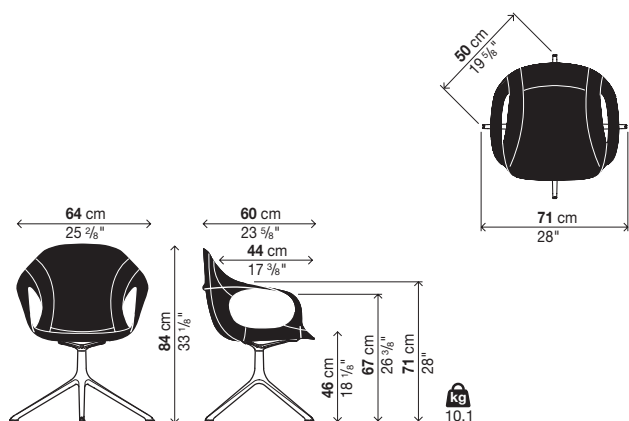

ELEPHANT

Trípode giratoria - Bastidor revestido en tejido (no desenfundable)

Acabado base:

Aluminio pulido

Aluminio barnizado (en los colores del poliuretano)

Acabado revestimiento:

B = COM (tejido Cliente)

D = Remix 2

E = Canvas 2, Hero, Melange Nap

F = Regal, Steelcut Trio 3

G = Divina Melange 3, Hallingdal 65

H = Twill Weave

Notas:

Para pedidos COM ver lado interno de la portada.

Para obtener información sobre las composiciones de los tejidos, ver lado interno de la portada.

PATAS:

Estándar en fieltro para suelos de madera.

Consumo COM: 1,5 ml (H. 140 cm).

Embalajes reforzados, ver lado interno de la portada.

Código	Base	Revestimiento											pack	m ²	Kg	
		A	B	C	D	E	F	G	H	L1	L2	L3				
05ELE54	Aluminio barnizado	-		-							-	-	-	1	0,38	13,5
	Aluminio pulido	-		-							-	-	-			

cada paquete contiene 1 butaca

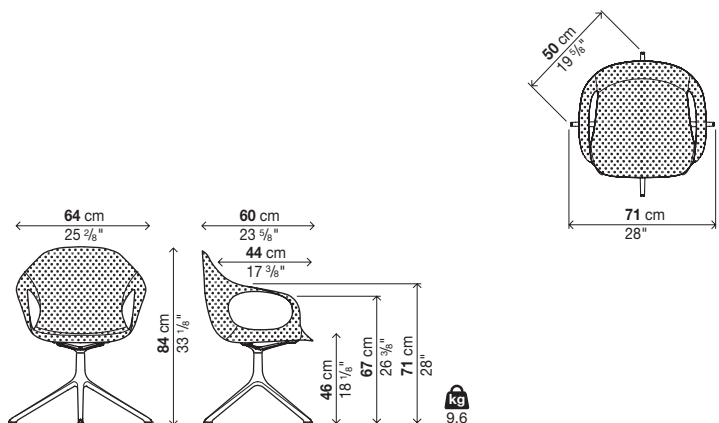

ELEPHANT

Cinco radios con ruedas - Bastidor de poliuretano

Acabado base:

Aluminio pulido
Aluminio barnizado (blanco, negro)

Acabado asiento:

Poliuretano blanco (P001)
Poliuretano negro (P003)
Poliuretano beige (P004)
Poliuretano terracota (P006)
Poliuretano verde oliva (P008)
Poliuretano rojo rubí (P010)
Poliuretano gris Londres (P011)
Poliuretano azul polvo (P012)

Acabado revestimiento cojín Elephant:

A = Valencia (piel sintética), COM (tejido Cliente)
B = Field 2
C = Clara 2, Merit
D = Curmi, Patio, Remix 2
E = Canvas 2, Hero, Melange Nap
F = Regal, Scuba, Steelcut Trio 3
G = Divina Melange 3, Hallingdal 65
H = Twill Weave

Acabado revestimiento cojín Lips:

A = COM (tejido Cliente)
B = Field 2

Notas:

Para pedidos COM ver lado interno de la portada.

Para obtener información sobre las composiciones de los tejidos, ver lado interno de la portada.

Ruedas pivotantes de tipo autofrenante con rodadura blanda.

INFORMACIÓN DE ENVÍO DESMONTABLE:

Para pedidos de más de 8 unidades, el producto se entrega desmontado (solo para sillas con asiento en poliuretano).

- 4 asientos = 1 pack - Kg 19 / m³ 0,41
- 1 bases = 1 pack - Kg 15 / m³ 0,14

Consumo cojín Elephant: 0,55 ml (H. 140 cm).

Consumo cojín Lips: 0,5 ml (H. 140 cm).

Embalajes reforzados, ver lado interno de la portada.

Código	Base	Asiento		
		pack	m ³	Kg
		Poliuretano		
05ELE41	Aluminio barnizado	1	0,38	13
	Aluminio pulido			

cada paquete contiene 1 butaca

Opcionales

Código	Descripción	Revestimiento										pack	m ³	Kg		
		A	B	C	D	E	F	G	H	L1	L2				L3	
20ELE01	Cojín extraíble Elephant (no desenfundable)										-	-	-	1	0,02	1
20LIR01	Cojín extraíble LIPS-R (no desenfundable)			-	-	-	-	-	-	-	-	-	-	1	0,01	1
20LIS01	Cojín extraíble LIPS-S (no desenfundable)			-	-	-	-	-	-	-	-	-	-	1	0,01	1

ELEPHANT (20ELE01)

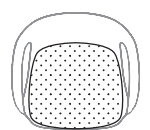

kg
0,6

LIPS-R (20LIR01)

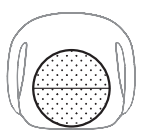

kg
0,6

LIPS-S (20LIS01)

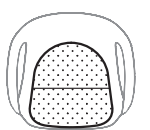

kg
0,6

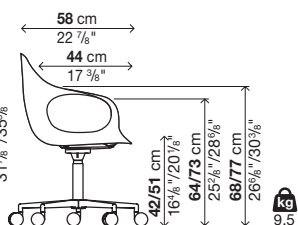
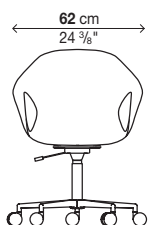
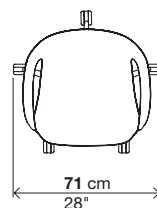

ELEPHANT

Cinco radios con ruedas - Bastidor revestido en cuero (no desenfundable)

Acabado base:

Aluminio pulido
Aluminio barnizado (blanco, negro)

Acabado revestimiento:

Segundo corte a cuero (C)
Cuero "plena flor" (PF) natural o negro

Notas:

Atención: las medidas o los acabados marcados con (!) tienen los tiempos de producción más largos, de aproximadamente 6 semanas desde la fecha del pedido.

Para colores costuras y bordes ver "reglas cuero" lado interno de la portada.

Ruedas pivotantes de tipo autofrenante con rodadura blanda.

Embalajes reforzados, ver lado interno de la portada.

Código	Base	Revestimiento		pack	m ³	Kg
		Segundo corte a cuero (C) (!)	Cuero "plena flor" (PF) (!)			
05ELE42	Aluminio barnizado			1	0,38	15,5
	Aluminio pulido					

cada paquete contiene 1 butaca

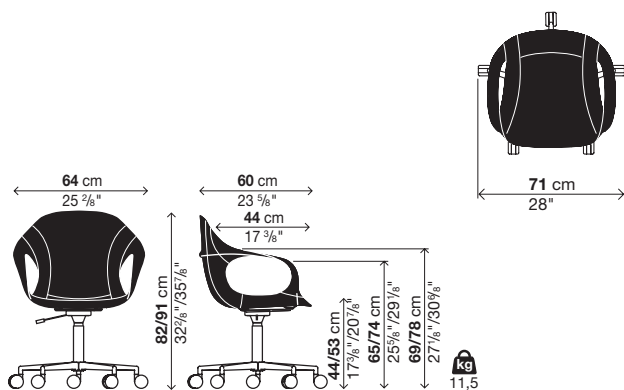

ELEPHANT

Cinco radios con ruedas - Bastidor revestido en tejido (no desenfundable)

Acabado base:

Aluminio pulido
Aluminio barnizado (blanco, negro)

Acabado revestimiento:

B = COM (tejido Cliente)
D = Remix 2
E = Canvas 2, Hero, Melange Nap
F = Regal, Steelcut Trio 3
G = Divina Melange 3, Hallingdal 65
H = Twill Weave

Notas:

Para pedidos COM ver lado interno de la portada.

Para obtener información sobre las composiciones de los tejidos, ver lado interno de la portada.

Ruedas pivotantes de tipo autofrenante con rodadura blanda.

Consumo COM: 1,5 ml (H. 140 cm).

Embalajes reforzados, ver lado interno de la portada.

Código	Base	Revestimiento											pack	m ²	Kg	
		A	B	C	D	E	F	G	H	L1	L2	L3				
05ELE43	Aluminio barnizado	-		-							-	-	-	1	0,38	15
	Aluminio pulido	-		-							-	-	-			

cada paquete contiene 1 butaca

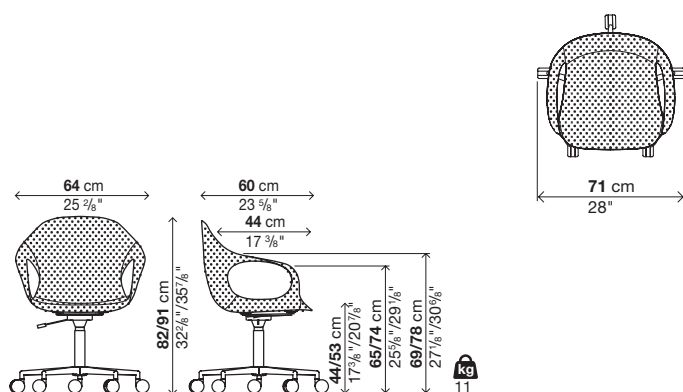

ELEPHANT

Butaca lounge - Bastidor de poliuretano

Acabado base:

Acero cromado
Acero cromado negro
Acero efecto latón
Acero barnizado (en los colores del poliuretano)

Acabado asiento:

Poliuretano blanco (P001)
Poliuretano negro (P003)
Poliuretano beige (P004)
Poliuretano terracota (P006)
Poliuretano verde oliva (P008)
Poliuretano rojo rubí (P010)
Poliuretano gris Londres (P011)
Poliuretano azul polvo (P012)

Acabado revestimiento cojín Elephant:

A = Valencia (piel sintética), COM (tejido Cliente)
B = Field 2
C = Clara 2, Merit
D = Curmi, Patio, Remix 2
E = Canvas 2, Hero, Melange Nap
F = Regal, Scuba, Steelcut Trio 3
G = Divina Melange 3, Hallingdal 65
H = Twill Weave

Acabado revestimiento cojín Lips:

A = COM (tejido Cliente)
B = Field 2

Notas:

Para pedidos COM ver lado interno de la portada.

Para obtener información sobre las composiciones de los tejidos, ver lado interno de la portada.

PATAS:

Estándar en plástico duro. Bajo pedido se suministran pies con inserto de fieltro para pisos de madera.

INFORMACIÓN DE ENVÍO DESMONTABLE:

Para pedidos de más de 8 unidades, el producto se entrega desmontado (solo para sillas con asiento en poliuretano).

- 4 asientos = 1 pack - Kg 19 / m³ 0,41

- 4 bases = 1 pack - Kg 14 / m³ 0,28

Consumo cojín Elephant: 0,55 ml (H. 140 cm).

Consumo cojín Lips: 0,5 ml (H. 140 cm).

Embalajes reforzados, ver lado interno de la portada.

Código	Base	Asiento		
		pack	m ³	Kg
		Poliuretano		
05ELE03	Acero barnizado, Acero cromado, Acero cromado negro	1	0,4	10
	Acero efecto latón			

cada paquete contiene 1 butaca

Opcionales

Código	Descripción	Revestimiento											pack	m ³	Kg
		A	B	C	D	E	F	G	H	L1	L2	L3			
20ELE01	Cojín extraíble Elephant (no desenfundable)									-	-	-	1	0,02	1
20LIR01	Cojín extraíble LIPS-R (no desenfundable)			-	-	-	-	-	-	-	-	-	1	0,01	1
20LIS01	Cojín extraíble LIPS-S (no desenfundable)			-	-	-	-	-	-	-	-	-	1	0,01	1
02PIE14	Juego de almohadillas de fieltro												-	-	-

ELEPHANT (20ELE01)

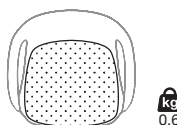

LIPS-R (20LIR01)

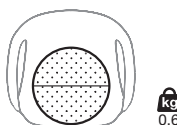

LIPS-S (20LIS01)

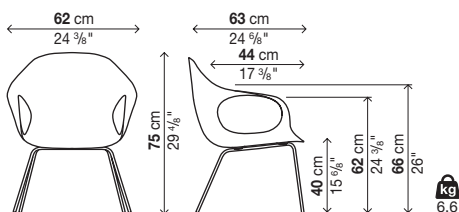

ELEPHANT

Butaca lounge - Bastidor revestido en cuero (no desenfundable)

Acabado base:

Acero cromado
 Acero cromado negro
 Acero efecto latón
 Acero barnizado (en los colores del poliuretano)

Acabado revestimiento:

Segundo corte a cuero (C)
 Cuero "plena flor" (PF) natural o negro

Notas:

Atención: las medidas o los acabados marcados con (!) tienen los tiempos de producción más largos, de aproximadamente 6 semanas desde la fecha del pedido.

Para colores costuras y bordes ver "reglas cuero" lado interno de la portada.

Embalajes reforzados, ver lado interno de la portada.

Código	Base	Revestimiento		pack	m ²	Kg
		Segundo corte a cuero (C) (!)	Cuero "plena flor" (PF) (!)			
05ELE13	Acero barnizado, Acero cromado, Acero cromado negro			1	0,4	11,5
	Acero efecto latón					

cada paquete contiene 1 butaca

Opcionales

Código	Descripción	pack	m ²	Kg
02PIE14	Juego de almohadillas de fieltro	-	-	-

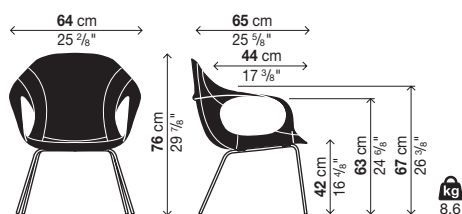

ELEPHANT

Butaca lounge - Bastidor revestido en tejido (no desenfundable)

Acabado base:

Acero cromado
Acero cromado negro
Acero efecto latón
Acero barnizado (en los colores del poliuretano)

Acabado revestimiento:

B = COM (tejido Cliente)
D = Remix 2
E = Canvas 2, Hero, Melange Nap
F = Regal, Steelcut Trio 3
G = Divina Melange 3, Hallingdal 65
H = Twill Weave

Notas:

Para pedidos COM ver lado interno de la portada.

Para obtener información sobre las composiciones de los tejidos, ver lado interno de la portada.

PATAS:

Estándar en plástico duro. Bajo pedido se suministran pies con inserto de fieltro para pisos de madera.

Consumo COM: 1,5 ml (H. 140 cm).

Embalajes reforzados, ver lado interno de la portada.

Código	Base	Revestimiento											pack	m ³	Kg	
		A	B	C	D	E	F	G	H	L1	L2	L3				
05ELE23	Acero barnizado, Acero cromado, Acero cromado negro	-		-							-	-	-	1	0,4	11
	Acero efecto latón	-		-							-	-	-			

cada paquete contiene 1 butaca

Opcionales

Código	Descripción	pack	m ³	Kg
02PIE14	Juego de almohadillas de fieltro	-	-	-

