

## Opal Toilet Roll Holder







### SPECIFICATION

PRODUCT CODE

2586

### AVAILABLE FINISH

	GRAPHITE NR2586GR		BRUSHED NICKEL NR2586BN
	BRUSHED BRONZE NR2586BZ		BRUSHED GOLD NR2586BG

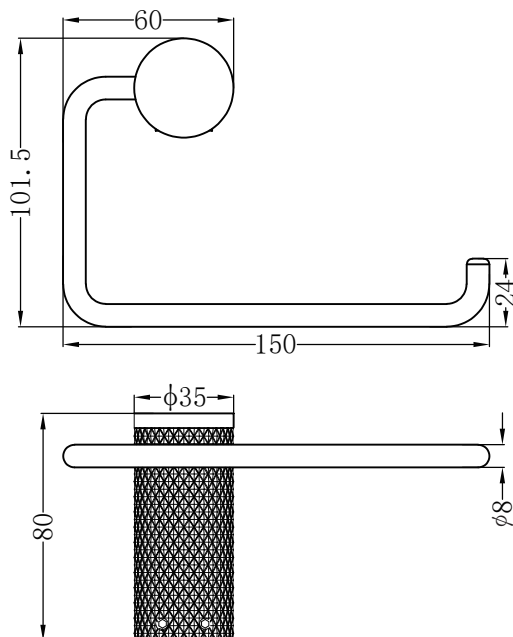

### MAINTENANCE AND CARE

All surfaces should be cleaned with mild liquid detergent or soap and water. Do not use cream cleaners or citrus based cleaning products, as they are abrasive. Use of unsuitable cleaning agents may damage the surface. Any damage caused in this way will not be covered by warranty.

### PACKING INCLUDES

- 1x toilet roll holder
- 1x installation kit





1

wall

1. Put the fixing blocks (piece) over on the right place on the wall , and stay level, use marking pen through the holes of fixing block to mark out fixing spots on the wall. Then drill holes by electric hand drill with 6mm drilling bit on the spots.



02

wall

2. Put the expansion plugs into the wall by hammer.



wall

3. Put fixing block cover on the holes and fix firmly by expansion screws.

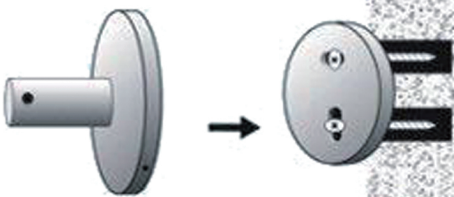

04

wall

4. Put the base of bathroom accessory cover on the fixing blocks.

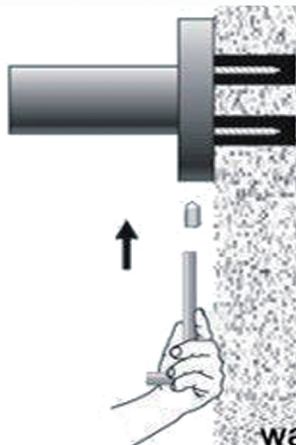

wall

5. Screw grub screws into the base, make it against to the fixing block tight and firm.