









## Mecca Shower Bracket With Air Shower



### SPECIFICATION

PRODUCT CODE	YSW2219-05
WELS RATING	3Star 9L/Min
WATERMARK LICENSE	WM-060093
TEMPERATURE RATING	Min 1°C-Max 75°C
PRESSURE RATING	Min 150KPa-Max 500Kpa

### AVAILABLE FINISH

	CHROME NR221905CH		BRUSHED BRONZE NR221905BZ
	MATTE BLACK NR221905MB		BRUSHED NICKEL NR221905BN
	GUN METAL NR221905GM		BRUSHED GOLD NR221905BG
	GRAPHITE NR221905GR		MATTE WHITE NR221905MW

### MAINTENANCE AND CARE

All surfaces should be cleaned with mild liquid detergent or soap and water. Do not use cream cleaners or citrus based cleaning products, as they are abrasive. Use of unsuitable cleaning agents may damage the surface. Any damage caused in this way will not be covered by warranty.

### PACKING INCLUDES

- 1x hand shower (built-in check valve)
- 1x shower bracket
- 1x 1.5m PVC hose
- 1x back plate
- 1x installation kit

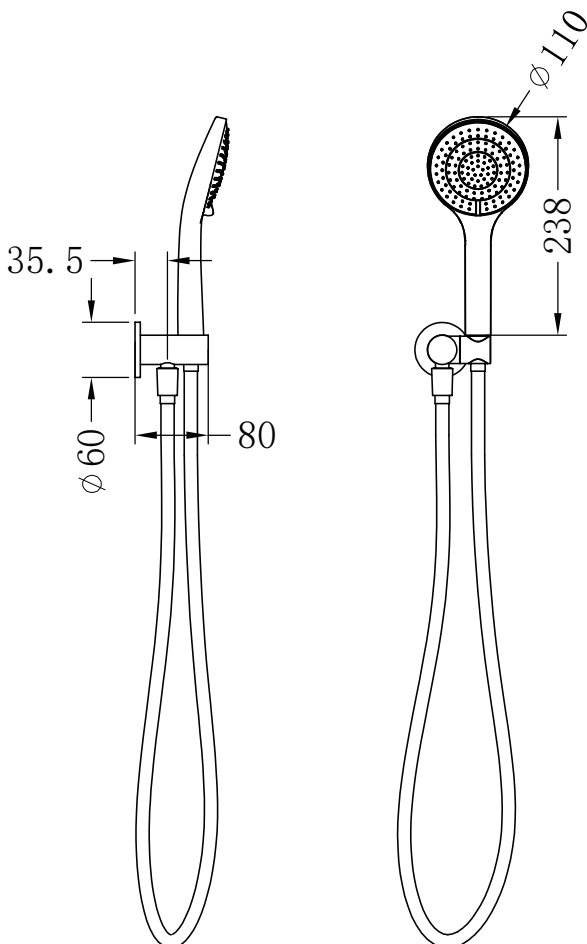

## Important

All products must be installed by licensed plumbers.

All pipework must be thoroughly flushed prior to installation, as foreign materials may block the flow regulating device and reduce the flow of water.



1. Apply thread sealant or teflon tape on outlet thread.

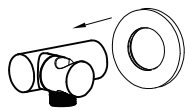

2. Pull back plate on together with bracket body.



3. Screw shower bracket body on to outlet. **DO NOT OVERTIGHTEN.** Slide the back plate against the wall/tile face properly.

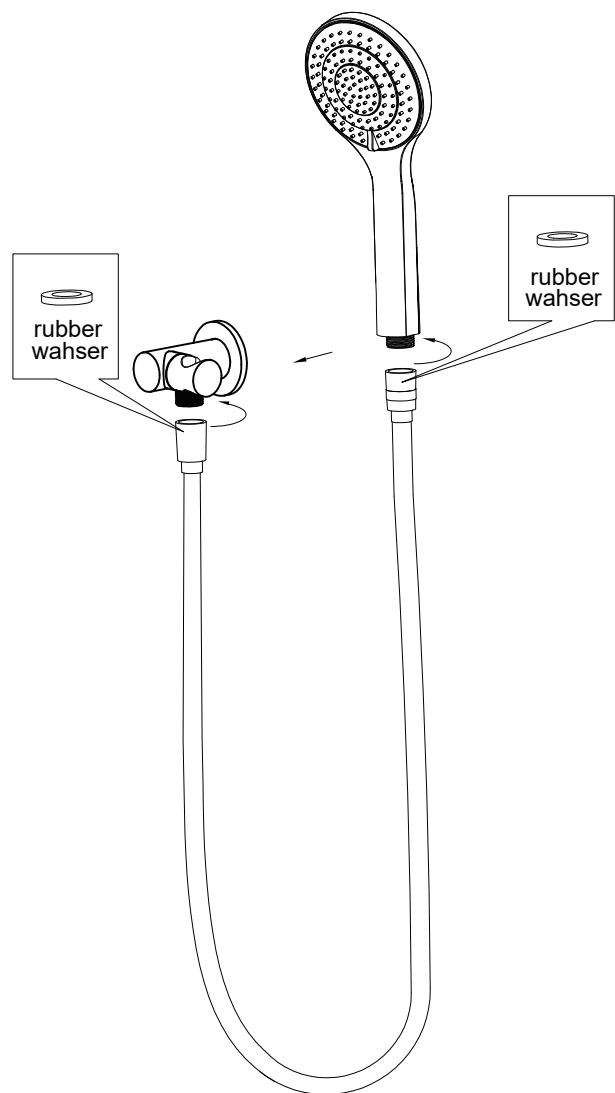

4. Connect bracket and hand shower with hose. **TEST & CHECK FOR LEAKS.**