

Hampton

900MM WALL-HUNG CABINET

Features

- Satin white exterior and interior
- Discrete pull-channels
- Soft-close drawers and full extension drawer runners
- 16 mm thick backing board and drawer bases
- FSC certified, eco-friendly E0 board

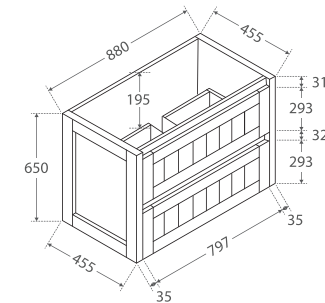

TOP VIEW: DRAWERS

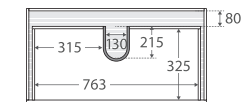

SIDE VIEW: RECESS & DRAWER STORAGE

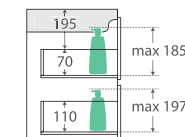

Available in



Satin White
90T-C

Cleaning & Care

- Regularly clean with mild soapy water using a clean, soft cloth.
- Do not use harsh detergents, bleach, abrasive cleaners or cream/wax cleaners. These substances can result in scratches and/or deposit build-ups that will affect the appearance.
- Avoid placing hot objects, such as hair straighteners, on any surface as these will cause discolouration and marking.
- Spills of hair dye, after-shave lotion, nail polish and remover, aerosol spray and other harsh chemicals should be removed immediately to prevent damage and discolouration. Clean immediately with mild soapy water using a clean, soft cloth.

While we aim to ensure specifications are correct at the time of publication, Fienza reserves the right to make modifications without prior notice. Physical colour may vary from image shown. All measurements are shown in millimetres. Always use physical product measurements for mark-ups and roughing-in as the technical drawing may differ from actual product received.

Sarah

UNDERMOUNTED BASIN-TOP 900MM

Features

- 20mm thick, engineered quartz stone
- Gloss white ceramic undermounted basin, with overflow
- Stone top and basin are delivered pre-joined
- Requires 32mm waste, with overflow (not included)
- 12 o'clock tap hole as standard
 - For 3 tap holes add \$50 per bowl to the price and '-3' to the end of the code e.g. SC90-3
 - For no tap holes add \$400 per bowl to the price and '-0' to the end of the code e.g. SC90-0. (SPECIAL ORDER ONLY – allow 1-2 weeks for delivery)

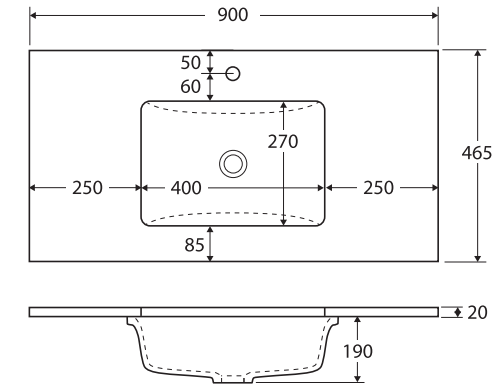

Available in



Crystal Pure
SC90



Calacatta Marble
SM90



Bianco Marble
SI90



Roman Sand
SA90



Dove Grey
SD90



Black Sparkle
SB90

Cleaning & Care

- Wipe with a clean, soft cloth and mild soapy water or non-abrasive bathroom cleaner. Test in an inconspicuous area before cleaning the whole top or basin.
- Avoid placing hot objects, such as hair straighteners, on any surface as these will cause discolouration and marking.
- Spills of hair dye, after-shave lotion, nail polish and remover, aerosol spray and other harsh chemicals should be removed immediately to prevent damage and discolouration. Clean immediately with mild soapy water using a clean, soft cloth.

While we aim to ensure specifications are correct at the time of publication, Fienza reserves the right to make modifications without prior notice. Physical colour may vary from image shown. All measurements are shown in millimetres. Always use physical product measurements for mark-ups and roughing-in as the technical drawing may differ from actual product received. Tapware not included.