

Rectangular Mirror

WITH MOUNTING BRACKETS

450 x 600 MM

Features

- CAT acrylic backing and resin emulsion painted to protect against corrosion and black spots
- 5 mm thick glass
- Copper free to prevent corrosion
- Can be mounted in portrait or landscape orientation using pre-attached, non-removable brackets

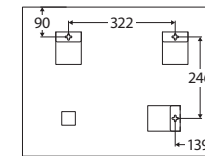
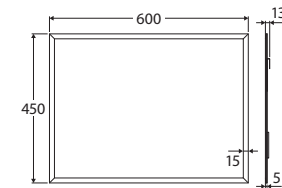
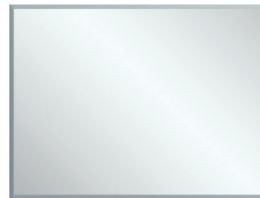

Available in



Bevel Edge
BEM-4560

Cleaning & Care

For best results, clean mirrors with a combination of 30% methylated spirits to 70% water and a soft, non-abrasive cloth designed for use on glass surfaces.

While we aim to ensure specifications are correct at the time of publication, Fienza reserves the right to make modifications without prior notice. Physical colour may vary from image shown. All measurements are shown in millimetres. Always use physical product measurements for mark-ups and roughing-in as the technical drawing may differ from actual product received.

Rectangular Mirror

WITH MOUNTING BRACKETS

600 x 750 MM

Features

- CAT acrylic backing and resin emulsion painted to protect against corrosion and black spots
- 5 mm thick glass
- Copper free to prevent corrosion
- Can be mounted in portrait or landscape orientation using pre-attached, non-removable brackets

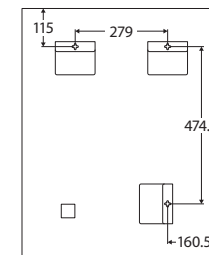
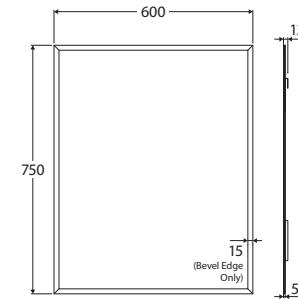

Available in



Bevel Edge
BEM-6075



Pencil Edge
PEM-6075

Cleaning & Care

For best results, clean mirrors with a combination of 30% methylated spirits to 70% water and a soft, non-abrasive cloth designed for use on glass surfaces.

While we aim to ensure specifications are correct at the time of publication, Fienza reserves the right to make modifications without prior notice. Physical colour may vary from image shown. All measurements are shown in millimetres. Always use physical product measurements for mark-ups and roughing-in as the technical drawing may differ from actual product received.

Rectangular Mirror

WITH MOUNTING BRACKETS

900 x 750 MM

Features

- CAT acrylic backing and resin emulsion painted to protect against corrosion and black spots
- 5 mm thick glass
- Copper free to prevent corrosion
- Can be mounted in portrait or landscape orientation using pre-attached, non-removable brackets

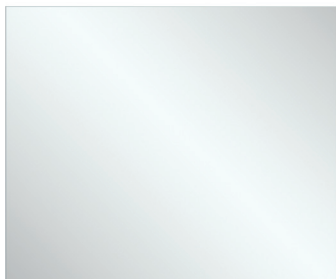
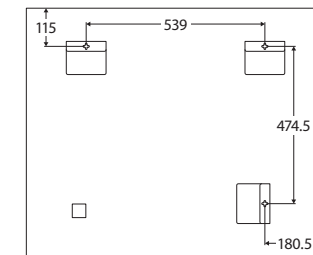
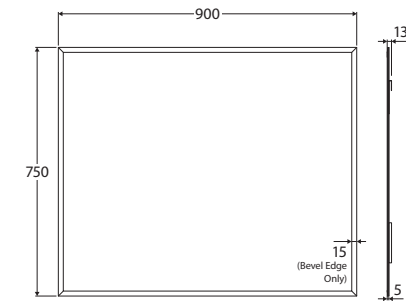
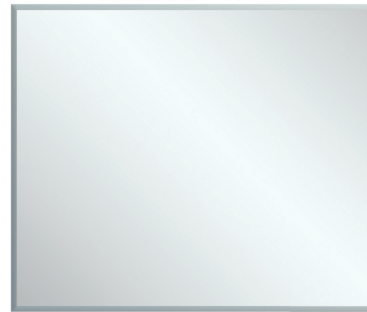

Available in



Bevel Edge
BEM-9075



Pencil Edge
PEM-9075

Cleaning & Care

For best results, clean mirrors with a combination of 30% methylated spirits to 70% water and a soft, non-abrasive cloth designed for use on glass surfaces.

While we aim to ensure specifications are correct at the time of publication, Fienza reserves the right to make modifications without prior notice. Physical colour may vary from image shown. All measurements are shown in millimetres. Always use physical product measurements for mark-ups and roughing-in as the technical drawing may differ from actual product received.

Rectangular Mirror

WITH MOUNTING BRACKETS

900 x 900 MM

Features

- CAT acrylic backing and resin emulsion painted to protect against corrosion and black spots
- 5 mm thick glass
- Copper free to prevent corrosion
- Can be mounted in portrait or landscape orientation using pre-attached, non-removable brackets

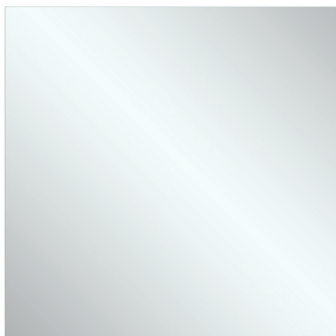
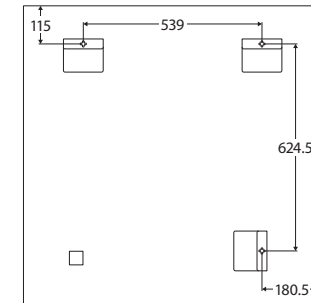
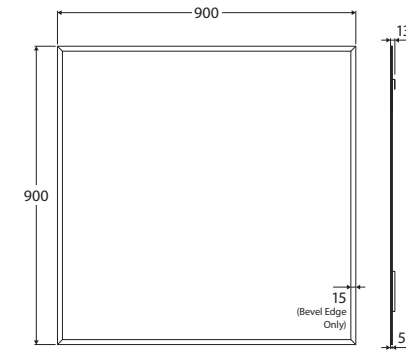

Available in



Bevel Edge
BEM-9090



Pencil Edge
PEM-9090

Cleaning & Care

For best results, clean mirrors with a combination of 30% methylated spirits to 70% water and a soft, non-abrasive cloth designed for use on glass surfaces.

While we aim to ensure specifications are correct at the time of publication, Fienza reserves the right to make modifications without prior notice. Physical colour may vary from image shown. All measurements are shown in millimetres. Always use physical product measurements for mark-ups and roughing-in as the technical drawing may differ from actual product received.

Rectangular Mirror

WITH MOUNTING BRACKETS

1200 x 800 MM

Features

- CAT acrylic backing and resin emulsion painted to protect against corrosion and black spots
- 5 mm thick glass
- Copper free to prevent corrosion
- Can be mounted in portrait or landscape orientation using pre-attached, non-removable brackets

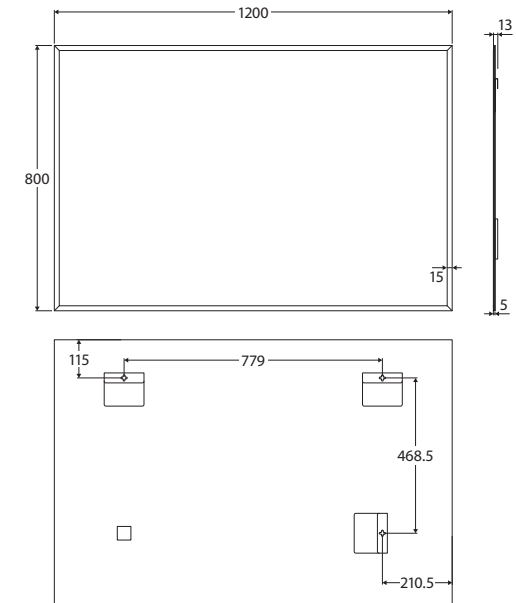
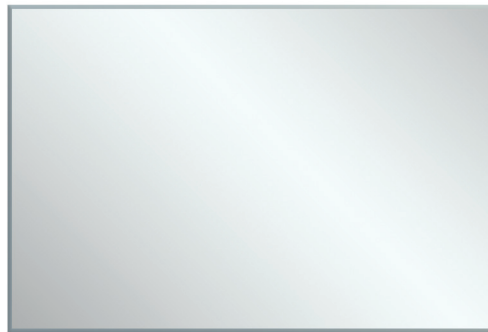

Available in



Bevel Edge
BEM-12080

Cleaning & Care

For best results, clean mirrors with a combination of 30% methylated spirits to 70% water and a soft, non-abrasive cloth designed for use on glass surfaces.

While we aim to ensure specifications are correct at the time of publication, Fienza reserves the right to make modifications without prior notice. Physical colour may vary from image shown. All measurements are shown in millimetres. Always use physical product measurements for mark-ups and roughing-in as the technical drawing may differ from actual product received.