

# Joli

## CERAMIC BASIN-TOP 900MM

### Features

- Soft curve design
- 18 mm thick vitreous china
- Gloss white finish
- 3 mm tile lip
- 12 o'clock tap hole as standard (3 tap holes also available)
- Integrated overflow
- Chrome overflow ring included
- Requires 32 mm overflow waste (available separately)

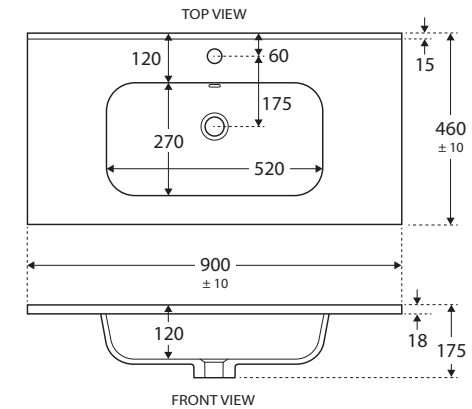

### Available in



1 tap hole  
**JOL90**



3 tap hole  
**JOL90-3**

### Cleaning & Care

- Wipe with a clean, soft cloth and mild soapy water or non-abrasive bathroom cleaner. Test in an inconspicuous area before cleaning the whole top.
- Avoid placing hot objects, such as hair straighteners, on any surface as these will cause discolouration and marking.
- Spills of hair dye, after-shave lotion, nail polish and remover, aerosol spray and other harsh chemicals should be removed immediately to prevent damage and discolouration. Clean immediately with mild soapy water using a clean, soft cloth.

While we aim to ensure specifications are correct at the time of publication, Fienza reserves the right to make modifications without prior notice. Physical colour may vary from image shown. All measurements are shown in millimetres. For ceramic products, please allow +/- 10 mm tolerance for manufacturing variance. Always use physical product measurements for mark-ups and roughing-in as the technical drawing may differ from actual product received.

# Amato®

## 900MM CABINET ON KICKBOARD WITH SOLID PANELS

### Features

- Customised options with solid side panels in four finishes
- Bevelled edge pull channel
- Interior drawer finish matches the external drawer fronts
- Full extension, soft close drawer runners
- 16 mm thick backing board and drawer bases
- Made from sustainably sourced timber

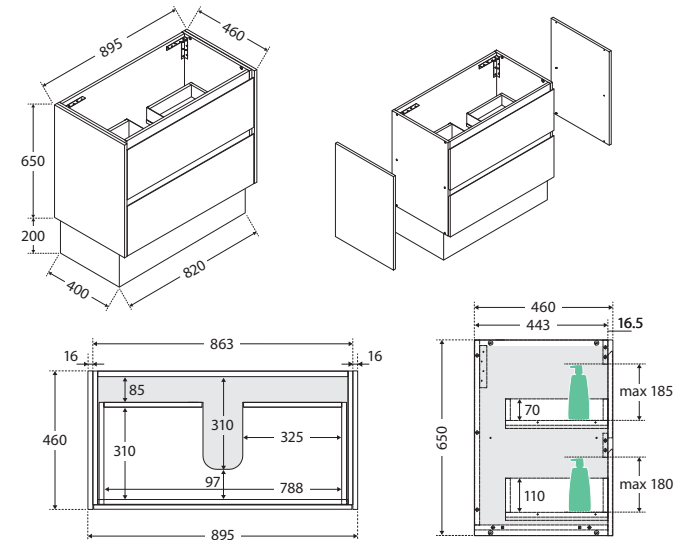

### Available in



Satin White with  
Satin White Panels  
**90BWK**



Scandi Oak with  
Scandi Oak Panels  
**90BSK**



Industrial with  
Industrial Panels  
**90BXK**



Satin Black with  
Satin Black Panels  
**90BBK**



Mixed finishes  
available. See our  
website for details.

### Cleaning & Care

- Regularly clean with mild soapy water using a clean, soft cloth.
- Do not use harsh detergents, bleach, abrasive cleaners or cream/wax cleaners. These substances can result in scratches and/or deposit build-ups that will affect the appearance.
- Avoid placing hot objects, such as hair straighteners, on any surface as these will cause discolouration and marking.
- Spills of hair dye, after-shave lotion, nail polish and remover, aerosol spray and other harsh chemicals should be removed immediately to prevent damage and discolouration. Clean immediately with mild soapy water using a clean, soft cloth.

While we aim to ensure specifications are correct at the time of publication, Fienza reserves the right to make modifications without prior notice. Physical colour may vary from image shown. All measurements are shown in millimetres. Always use physical product measurements for mark-ups and roughing-in as the technical drawing may differ from actual product received.