

Post mounted automatic hand sanitizer dispenser
Model PM2097

Note: To help fight the pandemic, SWIE Industries LLC extends the warranty to two years at no extra cost to customers. See warranty section for details.

For hand sanitizer and soap refills, visit www.swie.com.

Engineered for uses in hospitals, clinics, schools and other public areas, Swie makes sanitizer dispensing totally "hands-free", reducing the risk of cross infection. Our products use highly efficient, proprietary sensor technology to detect user's presence and dispense hand sanitizer gel.

Specifications

Capacity	1100ml (37.2 oz)
Liquid dosage	1ml
Battery type	4 "AA" Alkaline
Battery Life	> 60,000 cycles
Sensor range	3 inch (8 cm)

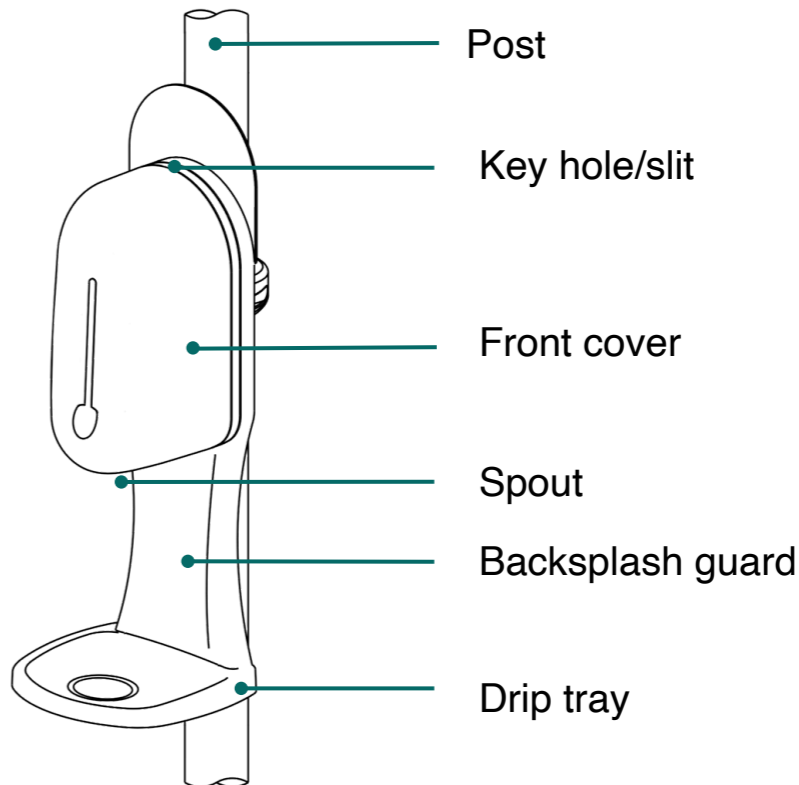

Included parts and accessories

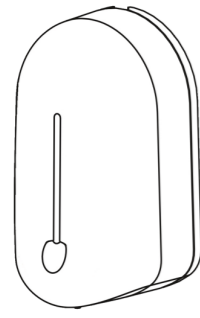

Dispenser

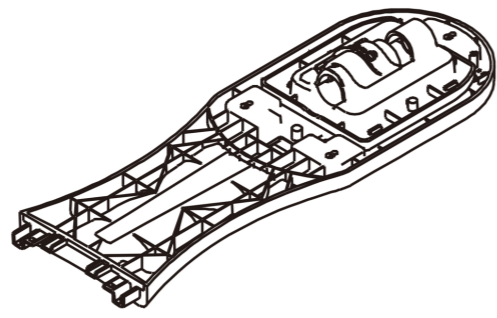

Backsplash

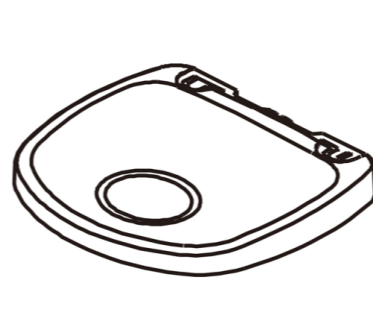

Drip tray

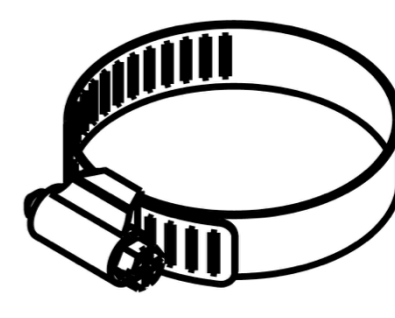

Clamp



Clamp cover



Message board

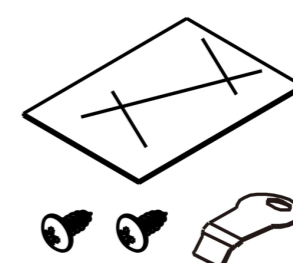

Accessories

Assembly instructions

Attention: Do not place this unit in areas where it could become covered in water.

Step 1 Firmly insert the backsplash into the grooves of the drip tray (FIG. 1).

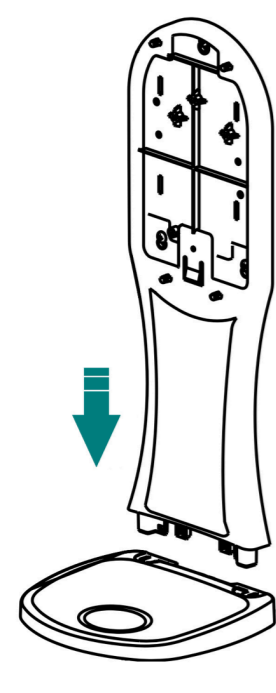

FIG. 1

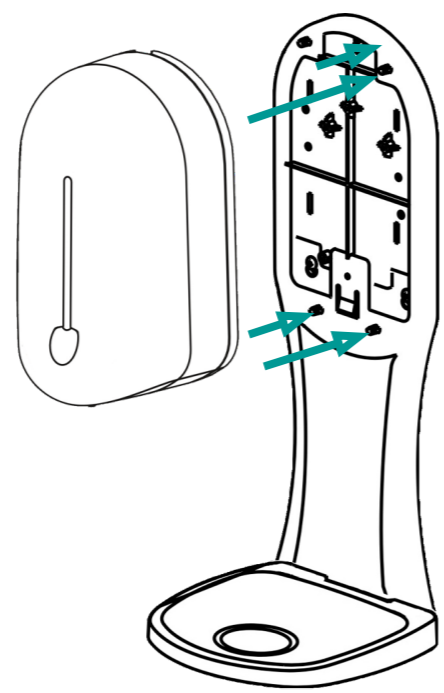

FIG. 2

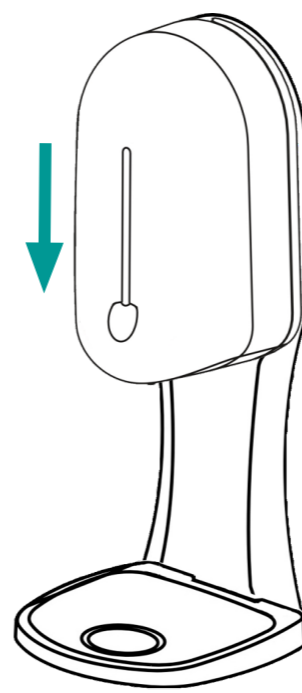

FIG. 3

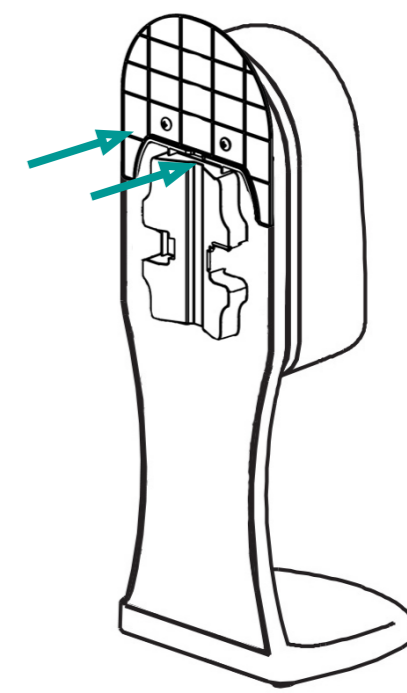

FIG. 4

Step 2 Align the 4 holes in the back of dispenser unit with the 4 hooks on the backsplash. Push the unit against the backsplash and then push the unit down towards the drip tray until the top of the unit is flush with the top of backsplash guard (FIG. 2, 3).

Attach the message board to the back of backsplash by driving 2 screws (FIG. 4). Installation of message board is optional.

Step 3 Secure the unit to the post

Insert the clamp into the mounting bracket at the back of backsplash (FIG. 5) and then wrap the clamp around the post (FIG. 6). Insert one end of the clamp into another and turn the screw clockwise to contract the clamp around the post to secure the unit.

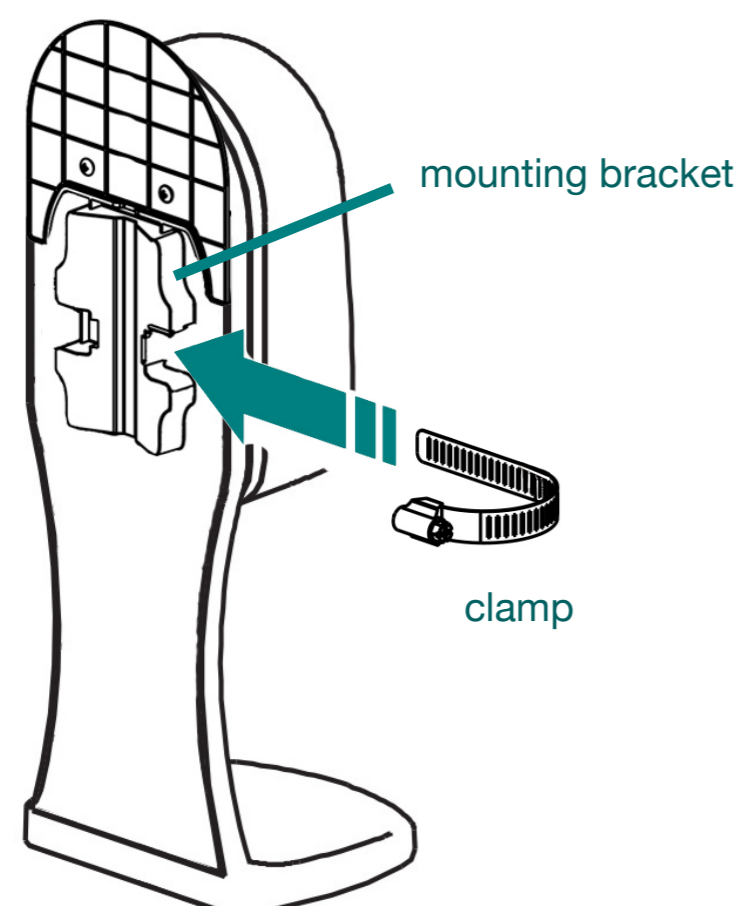

FIG. 5

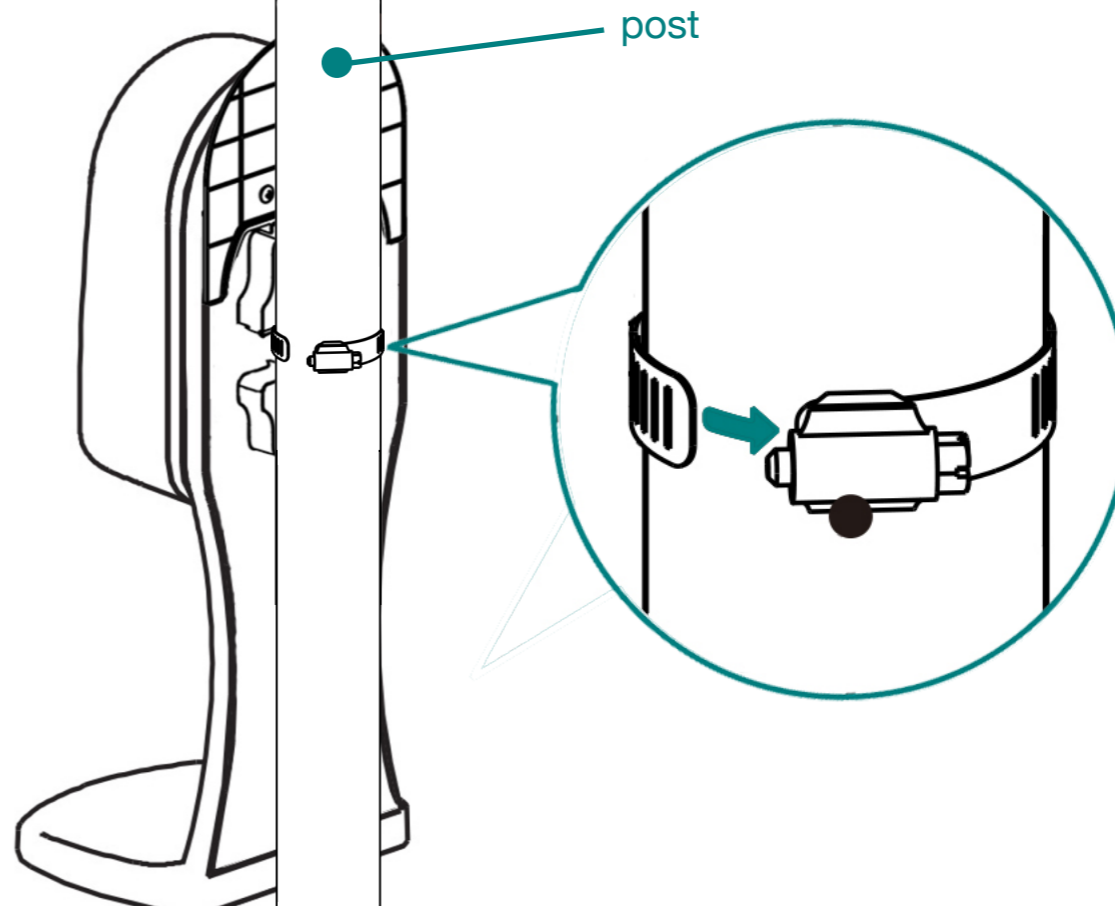

FIG. 6

Lastly install the clamp cover to conceal the clamp with two screws (FIG. 7).

Note: the unit comes with a clamp that can wrap around a post up to 1-3/4 inch (44 mm) diameter. You can purchase bigger clamps or zip ties for posts larger than 1-3/4 inch. Hose clamps or zip ties of various size are readily available at home centers or online.

Step 4 Install battery and add hand sanitizer

Lower the front cover by inserting the key into the key hole slit at the top of the unit and push the key bow (grip) upwards (FIG. 8).

To install battery, pull out the battery cover and insert 4 AA alkaline batteries (FIG. 9).

To add hand sanitizer, remove the cap and **slowly** pour liquid into the tank (FIG. 9). **CAUTION: Don't spill the liquid onto the unit, it would damage the dispenser. Wipe off spilled liquids immediately with rags or paper towel.**

Close the front cover. Now prime the pump (get the air out of the pump) by placing your hand under the spout. Do NOT withdraw your hands until the liquid begins to flow out of the spout (FIG. 10). Always prime the pump after refilling the tank.

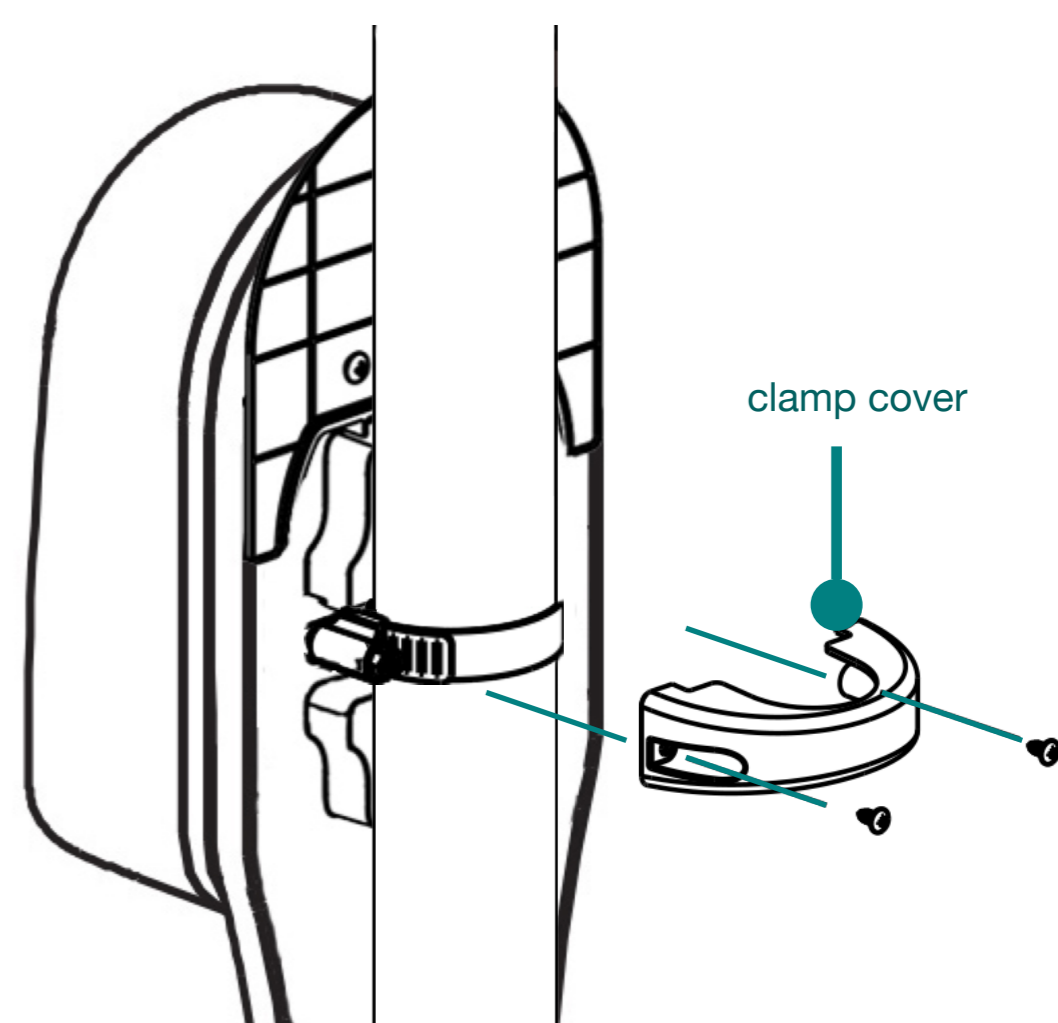

FIG. 7

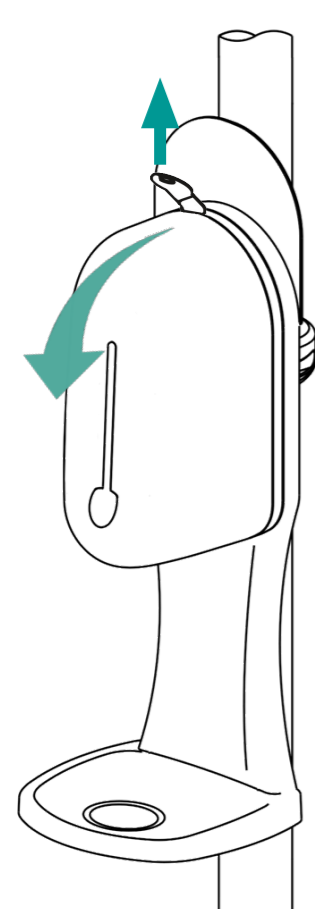

FIG. 8

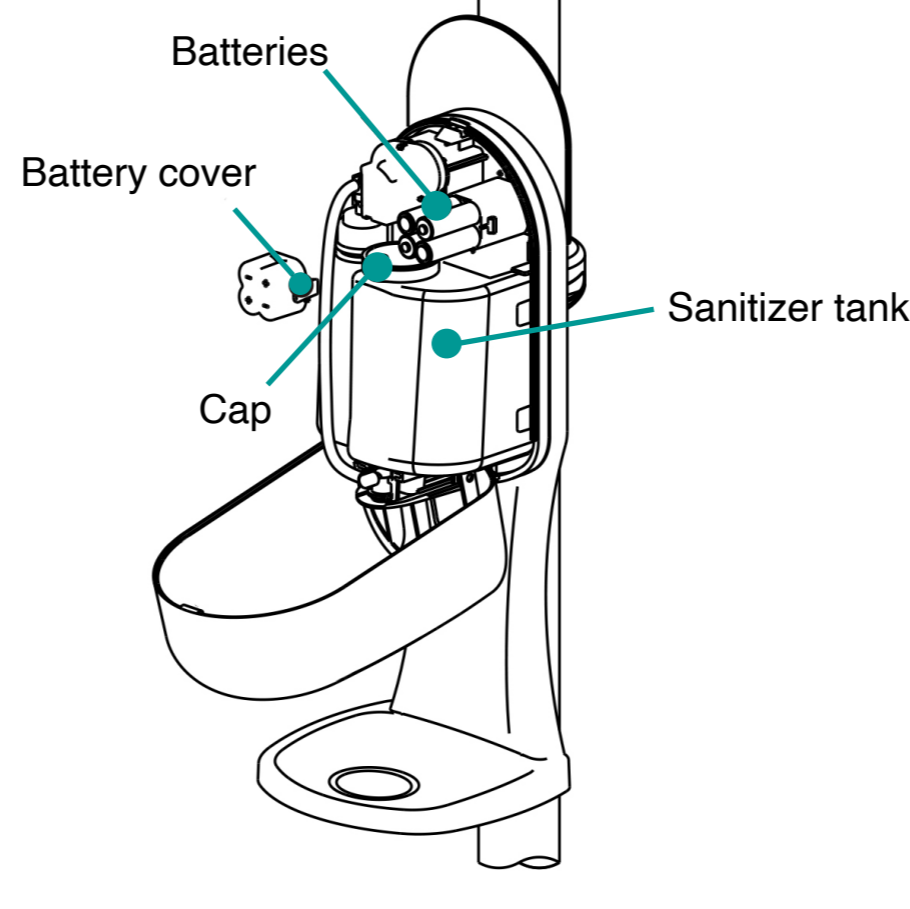

FIG. 9

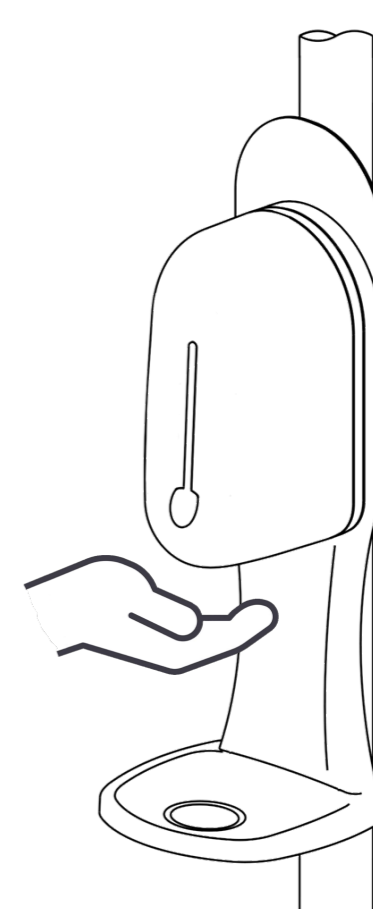

FIG. 10

How to use

- Place your hand under the dispenser spout within the sensing range (3 inches or less). The dispenser will automatically release the preset amount of liquid from the spout.
- If you need more liquid dispensed on your hand, do not withdraw your hand, the unit will continue to release the liquid for up to 10 doses or until you move your hand away.

Note: For first time use or after refilling the tank, the pump needs to be primed. Here is how - place your hand under the spout, do not withdraw your hands, let the unit run a few cycles until it starts to release liquid.

Troubleshooting

No dispensing, motor runs

- If this is the first use of the dispenser or you just refilled the liquid tank, place your hand under the spout (within 3 inch), do not withdraw, the unit will make several pumping actions, until the liquid begins to flow out of the spout.
- Tank is empty.
- Poor quality sanitizer or liquid soap.
- The liquid inside the unit could become solidified due to lack of use and/or cold/dry weather. Remove all liquid in the tank, fill it with warm soapy water and then place your hand under the spout until the water begins to flow out from the spout. Discard any remaining soapy water and refill the tank with sanitizer or liquid soap.

No dispensing, no motor sound

- Move hands closer to the spout.
- Make sure the front cover is fully closed.
- Clean the metal contacts inside battery holder and install new batteries.

Should the dispenser be out of order, contact Swie Industries LLC for support: service@swie.com or visit www.swie.com.

Maintenance

- If you will not be using the dispenser for an extended period of time, remove the batteries.
- If the unit has not been in use for extended period of time, install new battery and use fresh liquid (sanitizer or soap).
- Clean exterior surface with damp towel. Do not use abrasive cleaners.

2-YEAR WARRANTY

Swie Industries LLC warrants all its products to be made of first class materials, free from defects of material or workmanship under normal use and to perform for which they are intended in a thoroughly, reliable and efficient manner when properly installed and serviced, for a period of two years from date of purchase. During this period, Swie Industries LLC will, at its option, repair or replace any part or parts which prove to be thus defective if returned to Swie Industries LLC, at customer's cost, and this shall be the sole remedy available under this warranty. No claims will be allowed for labor, transportation or other incidental costs. This warranty does not cover the life of the batteries.

THERE ARE NO WARRANTIES WHICH EXTEND BEYOND THE DESCRIPTION ON THE FACE HEREOF. IN NO EVENT IS SWIE INDUSTRIES LLC RESPONSIBLE FOR ANY CONSEQUENTIAL DAMAGES OF ANY MEASURE WHATSOEVER.