

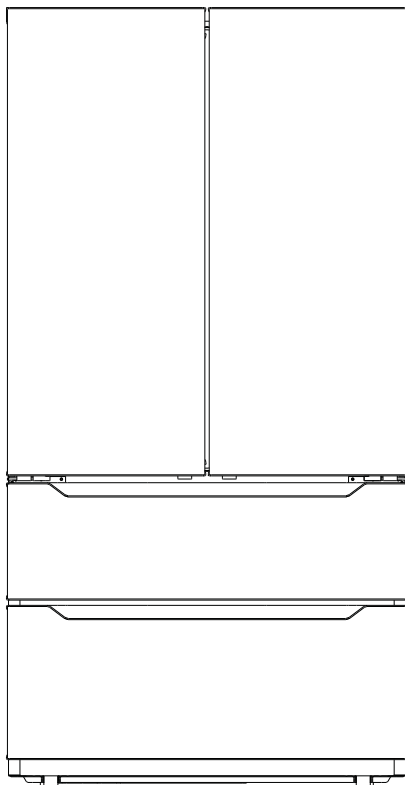

## **CARE AND USER MANUAL**

### Thor Kitchen French Door Refrigerator User Instructions

Model: HRF3602  
HRF3602BS



Please read this manual carefully before using the product

# CONTENTS

## 1 Safety warnings

1.1 Warning	1
1.2 Meanings of safety warning symbols	2
1.3 Electricity related warnings	2
1.4 Warnings for using	3
1.5 Warnings for placement	3-4
1.6 Warnings for energy	4
1.7 Warnings for disposal	4

## 2 Proper use of the refrigerator

2.1 Levelling feet	5
2.2 Levelling door	6
2.3 Changing the Light	7
2.4 Starting	7
2.5 Energy saving tips	7
2.6 Placement	8

## 3 Structure and functions

3.1 Key components	9-10
3.2 Functions	11-12

## 4 Maintenance and care of the refrigerator

4.1 Overall cleaning	13
4.2 Cleaning of door tray	13
4.3 Cleaning of shelf	14
4.4 Cleaning of freezer lower drawer	14
4.5 Defrosting	15
4.6 Out of operation	15

## 5 Trouble shooting

## Thor Group Refrigerator Warranty

17-18

# 1 Safety warnings

## 1.1 Warning



**Warning:** risk of fire / flammable materials

### RECOMMENDATIONS:

**This** appliance is intended to be used in household and similar applications such as staff kitchen areas in shops, offices and other working environments; farm houses and by clients in hotels, motels and other residential type environments; bed and breakfast type environments; catering and similar non-retail applications.

**If** the supply cord is damaged, it must be replaced by the manufacturer, its service agent or similarly qualified persons in order to avoid a hazard.

**Do** not store explosive substances such as aerosol cans with a flammable propellant in this appliance.

**The** appliance has to be unplugged after use and before carrying out user maintenance on the appliance.

**WARNING:** Risk of fire / flammable materials.

**WARNING:** Keep ventilation openings, in the appliance enclosure or in the built-in structure, clear of obstruction.

**WARNING:** Do not use mechanical devices or other means to accelerate the defrosting process, other than those recommended by the manufacturer.

**WARNING:** Do not damage the refrigerant circuit.

**WARNING:** Do not use electrical appliances inside the food storage compartments of the appliance, unless they are of the type recommended by the manufacturer.

**WARNING:** Please abandon the refrigerator according to local regulators for its use flammable blowing gas and refrigerant.

**WARNING:** When positioning the appliance, ensure the supply cord is not trapped or damaged.

**WARNING:** Do not locate multiple portable socket-outlets or portable power supplies at the rear of the appliance.

**Do** not use extension cords or ungrounded ( two prong ) adapters.

**DANGER:** Risk of child entrapment. Before you throw away your old refrigerator or freezer:

–Take off the doors.



–Leave the shelves in place so that children may not easily climb inside.

**The** refrigerator must be disconnected from the source of electrical supply before attempting the installation of accessory.

**Refrigerant** and cyclopentane foaming material used for the refrigerator are flammable. Therefore, when the refrigerator is scrapped, it shall be kept away from any fire source and be recovered by a special recovering company with corresponding qualification other than be disposed by combustion, so as to prevent damage to the environment or any other harm.

**Children** should be supervised to ensure that they do not play with the appliance.

## 1.2 Meaning of safety warning symbols

	This is a prohibition symbol. Any in compliance with instructions marked with this symbol may result in damage to the product or endanger the personal safety of the user.
	This is a warning symbol. It is required to operate in strict observance of instructions marked with this symbol; or otherwise damage to the product or personal injury may be caused.
	This is a cautioning symbol. Instructions marked with this symbol require special caution. Insufficient caution may result in slight or moderate injury, or damage to the product.

This manual contains lots of important safety information which shall be observed by the users.

## 1.3 Electricity related warnings

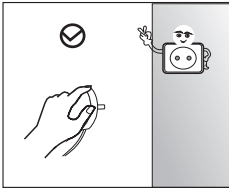

- Do not pull the power cord when pulling the power plug of the refrigerator. Please firmly grasp the plug and pull out it from the socket directly.
- To ensure safe use, do not damage the power cord or use the power cord when it is damaged or worn.

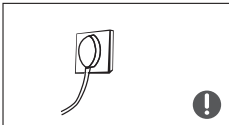

- Please use a dedicated power socket and the power socket shall not be shared with other electrical appliances. The power plug should be firmly contacted with the socket or else fires might be caused.
- Please ensure that the grounding electrode of the power socket is equipped with a reliable grounding line.



- Please turn off the valve of the leaking gas and then open the doors and windows in case of leakage of gas and other flammable gases. Do not unplug the refrigerator and other electrical appliances considering that spark may cause a fire.

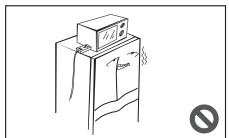

- Do not use electrical appliances on the top of the appliance, unless they are of the type recommended by the manufacturer.

## 1.4 Warnings for using

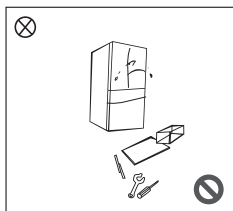

- Do not arbitrarily disassemble or reconstruct the refrigerator, nor damage the refrigerator circuit; maintenance of the appliance must be conducted by a specialist
- Damaged power cord must be replaced by the manufacturer, its maintenance department or related professionals in order to avoid danger.

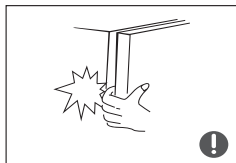

- The gaps between refrigerator doors and between doors and refrigerator body are small, be noted not to put your hand in these areas to prevent from squeezing the finger. Please be gentle when close the refrigerator door to avoid falling articles.
- Do not pick foods or containers with wet hands in the freezing chamber when the refrigerator is running, especially metal containers in order to avoid frostbite.



- Do not allow any child to get into or climb the refrigerator; otherwise suffocation or falling injury of the child may be caused.

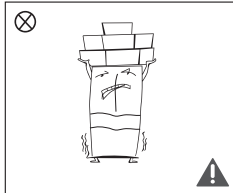

- Do not place heavy objects on the top of the refrigerator considering that objects may fall when close or open the door, and accidental injuries might be caused.
- Please pull out the plug in case of power failure or cleaning. Do not connect the refrigerator to power supply within five minutes to prevent damages to the compressor due to successive starts.

## 1.5 Warnings for placement of items

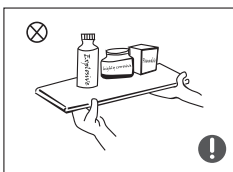

- Do not put flammable, explosive, volatile and highly corrosive items in the refrigerator to prevent damages to the product or fire accidents.
- Do not place flammable items near the refrigerator to avoid fires.

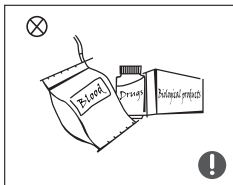

- The refrigerator is intended for household use, such as storage of foods; it shall not be used for other purposes, such as storage of blood, drugs or biological products, etc.

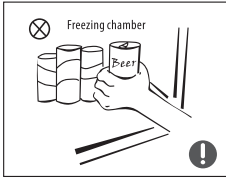

- Do not store beer, beverage or other fluid contained in bottles or enclosed containers in the freezing chamber of the refrigerator; or otherwise the bottles or enclosed containers may crack due to freezing to cause damages.

## 1.6 Warnings for energy

Warning for energy

- 1) Refrigerating appliances might not operate consistently (possibility of defrosting of contents or temperature becoming too warm in the frozen food compartment) when sited for an extended period of time below the cold end of the range of temperatures for which the refrigerating appliance is designed.
- 2) The fact that effervescent drinks should not be stored in food freezer compartments or cabinets or in low-temperature compartments or cabinets, and that some products such as water ices should not be consumed too cold;
- 3) The need to not exceed the storage time(s) recommended by the food manufacturers for any kind of food and particularly for commercially quick-frozen food in food-freezer and frozen-food storage compartments or cabinets;
- 4) The precautions necessary to prevent an undue rise in the temperature of the frozen food while defrosting the refrigerating appliance, such as wrapping the frozen food in several layers of newspaper.
- 5) The fact that a rise in temperature of the frozen food during manual defrosting, maintenance or cleaning could shorten the storage life.
- 6) The necessity that, for doors or lids fitted with locks and keys, the keys be kept out of the reach of children and not in the vicinity of the refrigerating appliance, in order to prevent children from being locked inside.

## 1.7 Warnings for disposal

Refrigerant and cyclopentane foaming material used for the refrigerator are flammable. Therefore, when the refrigerator is scrapped, it shall be kept away from any fire source and be recovered by a special recovering company with corresponding qualification other than be disposed by combustion, so as to prevent damage to the environment or any other harm.

When the refrigerator is scrapped, disassemble the doors, and remove gasket of door and shelves; put the doors and shelves in a proper place, so as to prevent trapping of any child.



Correct Disposal of this product :

This marking indicates that this product should not be disposed with other household wastes. To prevent possible harm to the environment or human health from uncontrolled waste disposal, recycle it responsibly to promote the sustainable reuse of material resources. To return your used device, please use the return and collection systems or contact the retailer where the product was purchased. They can take this product for environmental safe recycling.

## 2 Proper use of refrigerators

### 2.1 Levelling feet

#### 1) Precautions before operation

Information in the Instruction Manual is only for reference. Before operation of accessories, it shall be ensured that the refrigerator is disconnected from power. Before adjusting the leveling feet, precautions shall be taken to prevent any personal injury.

#### 2) Schematic diagram of the levelling feet

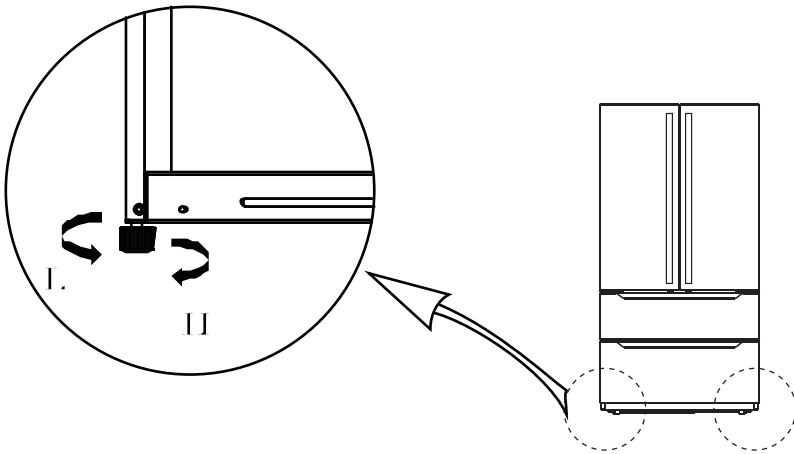

(The picture above is only for reference. The actual configuration will depend on the physical product or statement by the distributor)

#### 3) Adjusting procedures:

- a. Turn the feet clockwise to raise the refrigerator;
- b. Turn the feet counterclockwise to lower the refrigerator;
- c. Adjust the right and left feet based on the procedures above to a horizontal level.

## 2.2 Levelling door

### 1) Precautions before operation:

Information in the operation is only for reference.

Before operation of accessories, it shall be ensured that the refrigerator is disconnected from power.

Before adjusting the door, precautions shall be taken to prevent any personal injury.

### 2) Schematic diagram of leveling the door

List of tools to be provided by the user	
	plier

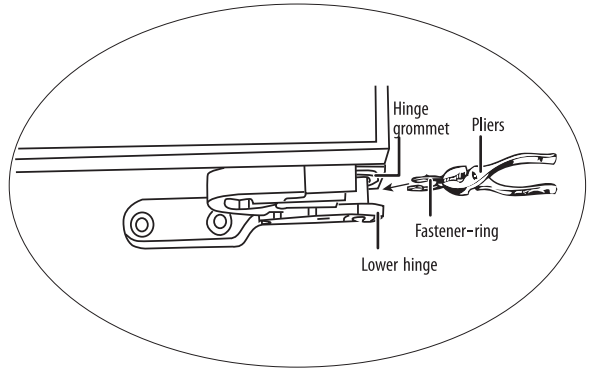
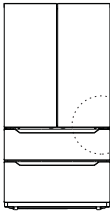
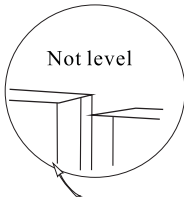

(The picture above is only for reference. The actual configuration will depend on the physical product or statement by the distributor)

1) Raise the lower door up to the level of the higher door.

2) Insert the supplied fastener-ring by using plier in the gap between the hinge-grommet and the lower hinge.

The number of fastener-rings you will need to insert depends on the gap.



## 2.3 Changing the Light

Any replacement or maintenance of the LED lamps is intended to be made by the manufacturer, its service agent or similar qualified person.

## 2.4 Starting

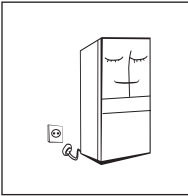

- Before initial start, keep the refrigerator still for two hours before connecting it to power supply.
- Before putting any fresh or frozen foods, the refrigerator shall have run for 2-3 hours, or for above 4 hours in summer when the ambient temperature is high.

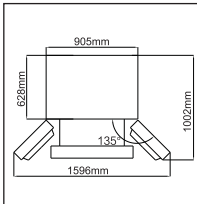

- Spare enough space for convenient opening of the doors and drawers or statement by the distributor.

## 2.5 Energy saving tips

- The appliance should be located in the coolest area of the room, away from heat producing appliances or heating ducts, and out of the direct sunlight.
- Let hot foods cool to room temperature before placing in the appliance. Overloading the appliance forces the compressor to run longer. Foods that freeze too slowly may lose quality, or spoil.
- Be sure to wrap foods properly, and wipe containers dry before placing them in the appliance. This cuts down on frost build-up inside the appliance.
- Appliance storage bin should not be lined with aluminum foil, wax paper, or paper toweling. Liners interfere with cold air circulation, making the appliance less efficient.
- Organize and label food to reduce door openings and extended searches. Remove as many items as needed at one time, and close the door as soon as possible.

## 2.6 Placement

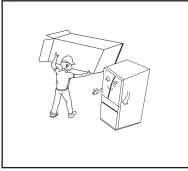

- Before use, remove all packing materials, including bottom cushions, foam pads and tapes inside of the refrigerator; tear off the protective film on the doors and the refrigerator body.

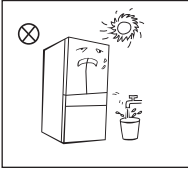

- Keep away from heat and avoid direct sunlight. Do not place the freezer in moist or watery places to prevent rust or reduction of insulating effect.
- Do not spray or wash the refrigerator; do not put the refrigerator in moist places easy to be splashed with water so as not to affect the electrical insulation properties of the refrigerator.

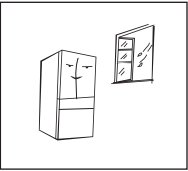

- The refrigerator is placed in a well-ventilated indoor place; the ground shall be flat, and sturdy (rotate left or right to adjust the adjustable leg for levelling if unstable).

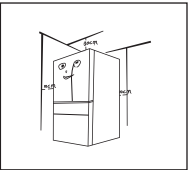

- The top space of the refrigerator shall be greater than 30cm, and the refrigerator should be placed against a wall with a free distance more than 10cm to facilitate heat dissipation.

- ⚠ Precautions before installation:  
Before installation or adjusting of accessories, it shall be ensured that the refrigerator is disconnected from power.  
Precautions shall be taken to prevent fall of the handle from causing any personal injury.

## 3 Structure and functions

### 3.1 Key components

( Refrigerating chamber )

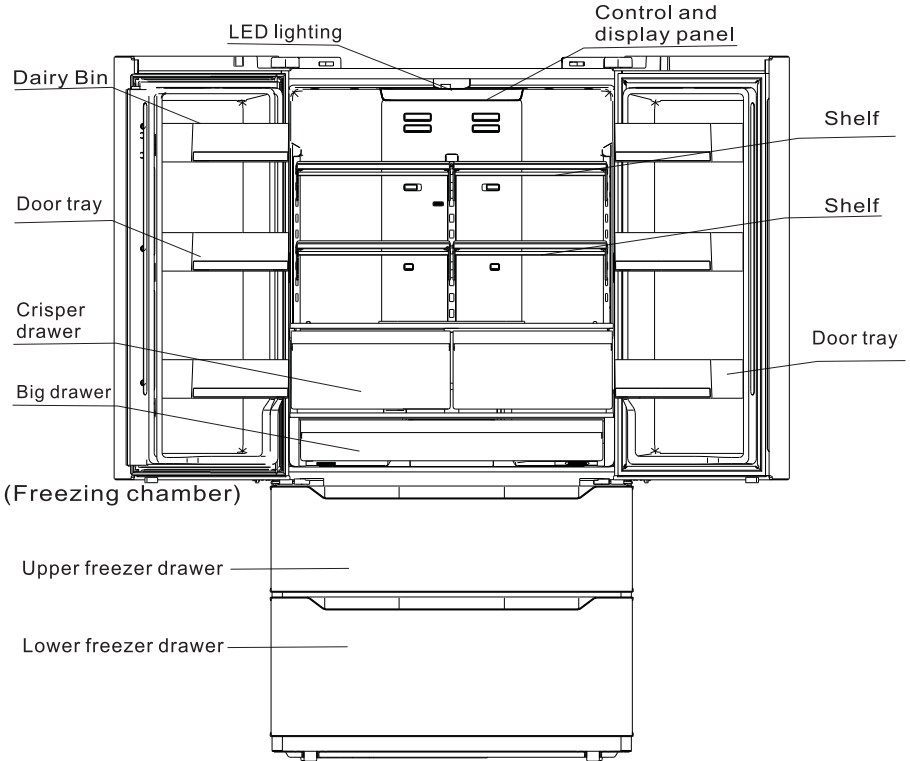

(The picture above is only for reference. The actual configuration will depend on the physical product or statement by the distributor)

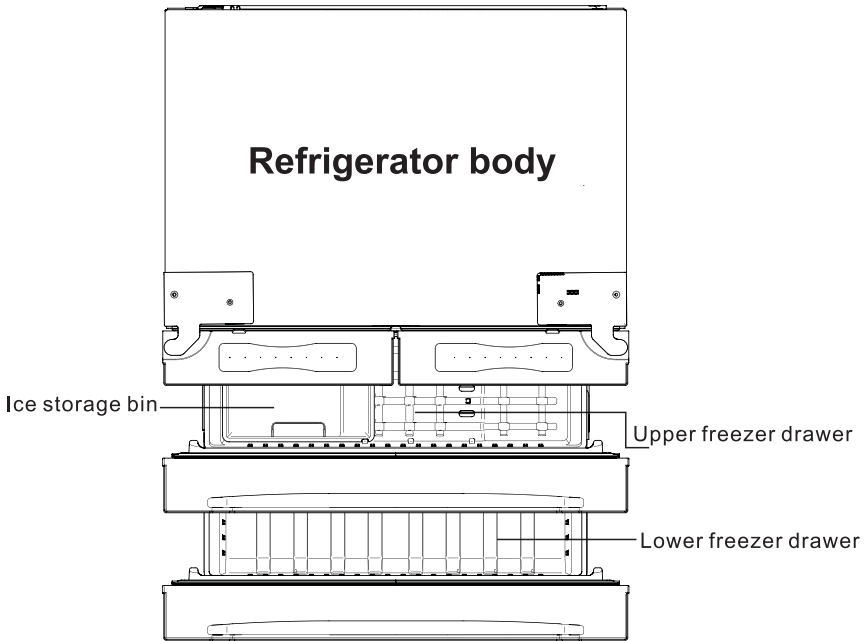

(The picture above is only for reference. The actual configuration will depend on the physical product or statement by the distributor)

### Refrigerating chamber

- The Refrigerating Chamber is suitable for storage of a variety of fruits, vegetables, beverages and other food consumed in the short term.
- Cooking foods shall not be put in the refrigerating chamber until cooled to room temperature.
- Foods are recommended to be sealed up before putting into the refrigerator.
- The glass shelves can be adjusted up or down for a reasonable amount of storage space and easy use.

### Freezing chamber

- The low temperature freezing chamber may keep food fresh for a long time and it is mainly used to store frozen foods and making ice.
- The freezing chamber is suitable for storage of meat, fish, rice balls and other foods not to be consumed in short term.
- Chunks of meat are preferably to be divided into small pieces for easy access. Please be noted food shall be consumed within the shelf time.

Note: Storage of too much food during operation after the initial connection to power may adversely affect the freezing effect of the refrigerator. Foods stored shall not block the air outlet; or otherwise the freezing effect will also be adversely affected.

## 3.2 Functions



(The picture above is only for reference. The actual configuration will depend on the physical product or statement by the distributor)

### 1. Buttons

- ① Ice-making button
- ② Super cool button
- ③ Temperature adjusting button of refrigerator room
- ④ Temperature adjusting button of freezer room
- ⑤ Super freeze button
- ⑥ Lock/unlock button

### 2. Display

- a) When electrify the refrigerator, the display screen will totally display for 3 seconds, meanwhile the starting up bell rings, then the display screen enters the normal display of operation. (if power-on for first time, the default set temperature of the refrigerator room and the freezer room is 41°F / 0°F).
- b) It will display the set temperature of both refrigerator and freezer rooms when there is no fault.
- c) Under normal circumstances, the display light will go out after 30 seconds in lock state, button operation on display panel would wake up the display screen; if the opening door action wakes up the display screen, the display light would go out immediately when the door is closed; when the "fault code visible" type of fault occurs, the display screen lights up, and will go out after 30 seconds.

### 3. Lock/Unlock

- a) In the unlock state, press and hold the lock/unlock button for 3 seconds to enter the lock state, and the buzzer sound rings.
- b) In the lock state, press and hold the lock button for 3 seconds to enter the unlock state and the buzzer sound rings.
- c) It will enter the lock state if there is no opening door action or any buttons operation within 30 seconds.
- d) The alarm sound can be stopped by pressing any one button in lock state, but all other button operations need to be performed in unlock state. If you operate in the lock state, an error beep will be given.

### 4. Refrigerator temperature setting

Click the temperature adjusting button of refrigerator room to change the set temperature of refrigerator room. Each time click the button, the set temperature will drop 1°F. when the set temperature reaches the 34°F, click the button again, the set temperature will switch to 44°F. The temperature setting will take effect after the display panel is locked.

### 5. Freezer temperature setting

Click the temperature adjusting button of freezer room to change the set temperature of freezer room. Each time click the button, the set temperature will drop 1°F. when the set temperature reaches the -7°F, click the button again, the set temperature will switch to 7°F. The temperature setting will take effect after the display panel is locked.

## 6. Mode setting

- 1) Press the **SUPER COOL** button to start the super cool function. The refrigerator room is set at 34°F automatically, and the **SUPER COOL** icon shines. When exit the super cool mode, the set temperature of refrigerator room will go back to the set temperature before super cool mode.
- 2) Press the **SUPER FRZ** button to start the super freeze function. The freezer room is set at -7°F automatically, and the **SUPER FRZ** icon shines. When exit the super freeze mode, the set temperature of freezer room will go back to the set temperature before super freeze mode.
- 3) Press the **ICE MAKER** button, the ice-making function could be switched between on/off. When the  icon is on, it indicates that the ice-making function is activated.

## 7. Error code

When the following tips to appear on the display screen, it indicates a problem with the refrigerator. Although the refrigerator in the following fault case can still provide cool/freeze functions, but the user should contact maintenance personnel, ensure the normal use of refrigerator.

Error code	Error description
E1	Temperature sensor failure of refrigerator room
E2	Temperature sensor failure of freezer room
E5	Defrost sensor error of freezer room
E6	Communication error
E7	Ambient temperature sensor error
EH	Humidity sensor error
E0	Ice maker error

## 4. Maintenance and care of the appliance

### 4.1 Overall cleaning

- Dusts behind the refrigerator and on the ground shall be timely cleaned to improve the cooling effect and energy saving. The interior of the refrigerator should be cleaned regularly to avoid odor. Soft towels or sponge dipped in water and non-corrosive neutral detergents are suggested for cleaning. The freezer of shall be finally cleaned with clean water and dry cloth. Open the door for natural drying before the power is turned on.
- Do not use hard brushes, clean steel balls, wire brushes, abrasives, such as toothpastes, organic solvents (such as alcohol, acetone, banana oil, etc.), boiling water, acid or alkaline items clean refrigerator considering that this may damage the fridge surface and interior.
- Do not rinse with water so as not to affect the electrical insulation properties.

 Please unplug the refrigerator for defrost and cleaning.



### 4.2 Cleaning of door tray

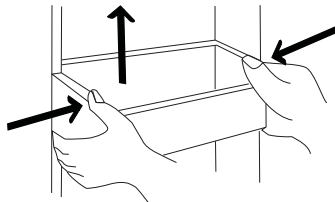

(The picture above is only for reference. The actual configuration will depend on the physical product or statement by the distributor)

- According to the direction arrow in the figure below, use both hands to squeeze the tray, and push it upward, then you can take it out.
- After washing the tray having been taken out, you can adjust its installing height in accordance with your requirement.

### 4.3 Cleaning of shelf

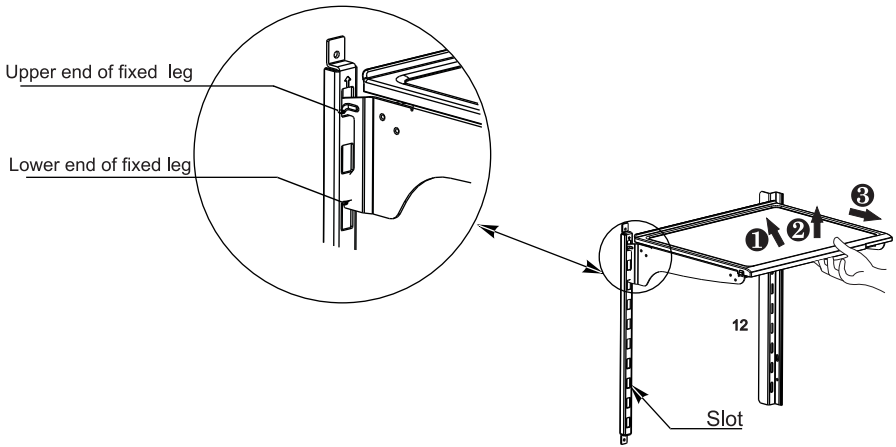

(The picture above is only for reference. The actual configuration will depend on the physical product or statement by the distributor)

- Please dismantle the cantilever shelf according to the arrows shown as above :
  - ① please hold the front edge of shelf, and tilt the shelf inwards until the lower end of fixed leg is separated from the slot of supporting iron;
  - ② uplift the whole shelf until it can not rise anymore;
  - ③ take out the shelf horizontally.
- During installation, put the upper end of the fixed leg into one of the upper slots on the supporting iron first and then put the lower end of the fixed leg into the third slot on the lower part of the supporting iron.

### 4.4 Cleaning of freezer lower drawer

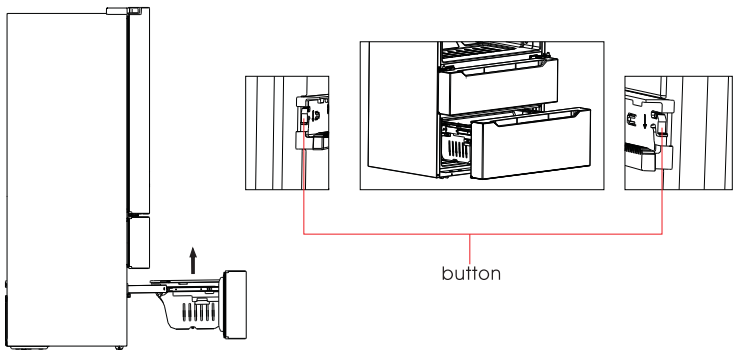

- Pull out the lower freezer drawer to the proper position.
- As shown in the Fig., press the buttons in both slots respectively (must press both sides at the same time), pull out the freezer drawer until it stops.
- Take out the lower drawer as directed by the arrows.
- After cleaning, put back the drawer to original position, then close the lower drawer, the button will lock the drawer automatically.  
Note: Don't remove the lower freezer drawer if not necessary.



## 4.5 Defrosting

- The refrigerator is made based on the air-cooling principle and thus has automatic defrosting function. Frost formed due to change of season or temperature may also be manually removed by disconnection of the appliance from power supply or by wiping with a dry towel.

## 4.6 Out of operation

- Power failure: In case of power failure, even if it is in summer, foods inside the appliance can be kept for several hours; during the power failure, the times of door opening shall be reduced, and no more fresh food shall be put into the appliance.
- Long-time nonuse: The appliance shall be unplugged and then cleaned; then the doors are left open to prevent odor.
- Moving: Before the refrigerator is moved, take all objects inside out, fix the glass partitions, vegetable holder, freezing chamber drawers and etc. with tape, and tighten the levelling feet; close the doors and fix them with tape. During moving, the appliance shall not be laid upside down or horizontally, or be vibrated; the inclination during movement shall be no more than 45°.



The appliance shall run continuously once it is started. Generally, the operation of the appliance shall not be interrupted; otherwise the service life may be impaired.

## 5 Trouble shooting

You may try to solve the following simple problems by yourself. If them cannot be solved, please contact the after-sales department.

Failed operation	<p>Check whether the appliance is connected to power or whether the plug is in well contact .</p> <p>Check whether the voltage is too low.</p> <p>Check whether there is a power failure or partial circuits have tripped.</p>
Odor	<p>Odorous foods shall be tightly wrapped.</p> <p>Check whether there is any rotten food.</p> <p>Clean the inside of the refrigerator.</p>
Long-time operation of the compressor	<p>Long operation of the refrigerator is normal in summer when the ambient temperature is high.</p> <p>It is not recommended having too much food in the appliance at the same time.</p> <p>Food shall get cool before being put into the appliance.</p> <p>The doors are opened too frequently.</p>
Light fails to get lit	<p>Check whether the refrigerator is connected to power supply and whether the illuminating light is damaged.</p>
Doors cannot be properly closed	<p>The door is stuck by food packages.</p> <p>The refrigerator is tilted.</p>
Loud noise	<p>Check whether the floor is level and whether the refrigerator is placed stably.</p> <p>Check whether accessories are placed at proper locations.</p>
Door seal fails to be tight	<p>Remove foreign matters on the door seal.</p> <p>Heat the door seal and then cool it for restoration (or blow it with an electrical drier or use a hot towel for heating).</p>
Water pan overflows	<p>There is too much food in the chamber or food stored contains too much water,resulting in heavy defrosting.</p> <p>The doors are not closed properly, resulting in frosting due to entry of air and increased water due to defrosting.</p>
Hot housing	<p>Heat dissipation of the built-in condenser via the housing, which is normal.</p> <p>When housing becomes hot due to high ambient temperature and storage of too much food,it is recommended to provide sound ventilation to facilitate heat dissipation.</p>
Surface condensation	<p>Condensation on the exterior surface and door seals of the refrigerator is normal when the ambient humidity is too high. Just wipe the condensate with a clean towel.</p>
Abnormal noise	<p>Buzz: The compressor may produce buzzes during operation, and the buzzes are loud particularly upon start or stop. This is normal.</p> <p>Creak: Refrigerant flowing inside of the appliance may produce creak, which is normal.</p>

---

# Thor Group Refrigerator Warranty

---

## 2 YEAR LIMITED WARRANTY ON PARTS AND LABOR

For two year from the date of purchase, when this refrigerator is operated and maintained according to instructions attached to or furnished with the product, Thor Group will pay for Factory Specified Parts and repair labor to correct defects in materials or workmanship that existed when this major appliance was purchased. Service must be provided by a Thor Group designated service technician. YOUR SOLE AND EXCLUSIVE REMEDY UNDER THIS LIMITED WARRANTY SHALL BE PRODUCT REPAIR AS PROVIDED HEREIN. This limited warranty is valid only in the United States or Canada and applies only when the major appliance is used in the country in which it was purchased. Proof of original purchase date is required to obtain service under this limited warranty.

### ITEMS EXCLUDED FROM WARRANTY

**This limited warranty does not cover:**

1. Replacement parts or repair labor if this major appliance is used for other than normal, single-family household use or when it is used in a manner that is inconsistent to published user or operator instructions and/or installation instructions.
2. Service calls to correct the installation of your major appliance, to instruct you on how to use your major appliance, to replace or repair house fuses, or to correct house wiring or plumbing.
3. Service calls to repair or replace appliance light bulbs, air filters or water filters. Consumable parts are excluded from warranty coverage.
4. Damage resulting from accident, alteration, misuse, abuse, fire, flood, acts of God, improper installation, installation not in accordance with electrical or plumbing codes, or use of products not approved by Thor Group.
5. Cosmetic damage, including scratches, dents, chips or other damage to the finish of your major appliance, unless such damage results from defects in materials or workmanship and is reported to Thor Group within 30 days from the date of purchase.
6. Any food or medicine loss due to refrigerator or freezer product failures.
7. Pickup and delivery. This major appliance is intended to be repaired in your home.
8. Repairs to parts or systems resulting from unauthorized modifications made to the appliance.
9. Expenses for travel and transportation for product service if your major appliance is located in a remote area where service by an authorized Thor Group servicer is not available.
10. The removal and reinstallation of your major appliance if it is installed in an inaccessible location or is not installed in accordance with Thor Group's published installation instructions.
11. Replacement parts or repair labor on major appliances with original model/serial numbers that have been removed, altered or cannot be easily determined.
12. Discoloration, rust, or oxidation of stainless steel surfaces.
13. In any circumstance, Thor does not pay for food loss claims on refrigerator products.

The cost of repair or replacement under these excluded circumstances shall be borne by the customer.

### DISCLAIMER OF IMPLIED WARRANTIES

IMPLIED WARRANTIES, INCLUDING ANY IMPLIED WARRANTY OF MERCHANTABILITY OR IMPLIED WARRANTY OF FITNESS FOR A PARTICULAR PURPOSE, ARE LIMITED TO TWO YEAR OR THE SHORTEST PERIOD ALLOWED BY LAW. Some states and provinces do not allow limitations on the duration of implied warranties of merchantability or fitness, so this limitation may not apply to you. This warranty gives you specific legal rights, and you also may have other rights that vary from state to state or province to province.

## LIMITATION OF REMEDIES; EXCLUSION OF INCIDENTAL AND CONSEQUENTIAL DAMAGES

YOUR SOLE AND EXCLUSIVE REMEDY UNDER THIS LIMITED WARRANTY SHALL BE PRODUCT REPAIR AS PROVIDED HEREIN. THOR GROUP SHALL NOT BE LIABLE FOR INCIDENTAL OR CONSEQUENTIAL DAMAGES. Some states and provinces do not allow the exclusion or limitation of incidental or consequential damages, so these limitations and exclusions may not apply to you. This warranty gives you specific legal rights, and you also may have other rights that vary from state to state or province to province. If outside the 50 United States, contact Thor Group Service Department to determine if another warranty applies.

**For Additional Product Information, Visit [www.ThorKitchen.Com](http://www.ThorKitchen.Com).**

- If you do not have access to the Internet and you need assistance using your product or you would like to schedule service, you may contact Thor Group at the number below.
- Have your complete model number ready. You can find your model number and serial number on the label, located on the inside wall of the refrigerator compartment.
- For assistance or service in the U.S.A., call 1-877-288-8099.
- If you need further assistance, you can write to Thor Group with any questions or concerns at the address below:

**Thor Group**  
Customer Service Department  
13831 Oaks Avenue  
Chino, CA 91710.

Please include a daytime phone number in your correspondence.

Please keep all provided instructions and your model number information for future reference.

### Warranty and Product Registration

Model Number	_____	Serial No.	_____
Date of Purchase	_____	Purchaser	_____
Dealer	_____	Suburb	_____
Town	_____	Country	_____

**Note: You must provide proof of purchased or installation date for in-warranty service.**