

24 INCH INDOOR OUTDOOR FREEZER DRAWER TRZ24U

# COOK LIKE A GOD

**THOR**  
K I T C H E N<sup>®</sup>

**USE & CARE MANUAL**

USE AND CARE MANUAL

# 24 INCH INDOOR OUTDOOR FREEZER DRAWER

TRZ24U

**THOR**  
K I T C H E N<sup>®</sup>

# TABLE OF CONTENTS

---

<b>Appliance Safety</b>	<b>2</b>
<b>Important Safeguards</b>	<b>3</b>
<b>Installation Instructions</b>	<b>4 - 7</b>
Before Using Your Appliance	4
Installation of Your Appliance	4
Site Preparation	4
Anti-tip Bracket Installation	5
Names Of The Parts	6
Specifications	6
Leveling the Unit	7
Installing Handle	7
Electrical Connection	7
Extension Cord	7
<b>Operating Your Appliance</b>	<b>8</b>
Control Panel	8
Defrosting	8
Alarm and Error Code	9
<b>Care and Maintenance</b>	<b>9 - 10</b>
Clearing and Maintaining Your Appliance	9
Power Failure	10
Vacation Time	10
Moving Your Appliance	10
Energy Saving Tips	10
<b>Troubleshooting</b>	<b>11</b>
<b>Warranty</b>	<b>12</b>

# APPLIANCE SAFETY

**Your safety and the safety of others are very important.**

We have provided many important safety messages in this manual and on your appliance. Always read and obey all safety messages.



This is the Safety Alert Symbol. The symbol alerts you to potential hazards that can kill or injure you and others. All safety messages will follow the Safety Alert Symbol and either the word **DANGER** or **WARNING**.



**DANGER** means that failure to heed this safety statement may result in severe personal injury or death.



**WARNING** means that failure to heed this safety statement may result in extensive product damage, serious personal injury, or death.

All safety messages will alert you about the potential hazard, tell you how to reduce the chance of injury, and let you know what can happen if the instructions are not followed.

# IMPORTANT SAFEGUARDS



Before the appliance is used, it must be properly positioned and installed as described in this manual, so read the manual carefully. To reduce the risk of fire, electrical shock or injury when using the appliance, follow basic precautions, including the following:

## **DANGER**

Plug into a grounded 3 prong outlet, do not remove grounding prong, do not use an adapter, and do not use an extension cord.

Replace all panels before operating

It is recommended that a separate circuit serving only your appliance be provided. Use receptacles that cannot be turned off by a switch or pull chain

Never clean appliance parts with flammable fluids. These fumes can create a fire hazard or explosion.

And do not store or use gasoline or other flammable vapors and liquids in the vicinity of this or any other appliance. The fumes can create a fire hazard or explosion.

Do not connect or disconnect the electric plug when your hands are wet.

Unplug the appliance or disconnect power before cleaning or servicing. Failure to do so can result in electrical shock or death.

Do not attempt to repair or replace any part of your appliance unless it is specifically recommended in this manual. All other servicing should be referred to a qualified technician.

### FOLLOW WARNING CALLOUTS BELOW ONLY WHEN APPLICABLE TO YOUR MODEL

Use two or more people to move and install appliance. Failure to do so can result in back or other injury.

To ensure proper ventilation for your appliance, the front of the unit must be completely unobstructed.

Choose a well-ventilated area with temperatures above 50°F (10°C) and below 100.4 °F (38 °C)

The appliance should not be located next to ovens, grills or other sources of high heat.

The appliance must be installed with all electrical, water and drain connections in accordance with state and local codes. A standard electrical supply (115 V AC only, 60 Hz), properly grounded in accordance with the National Electrical Code and local codes and ordinances, is required

Do not kink or pinch the power supply cord of the appliance.

The size of the fuse (or circuit breaker) should be 1.3 amperes.

It is important that the appliance be leveled in order to work properly. You may need to make several adjustments to level it.

All installations must be in accordance with local plumbing code requirements.

Make certain that the pipes are not pinched, kinked or damaged during installation.

Check for leaks after connection

Never allow children to operate, play with or crawl inside the appliance.

Do not use solvent-based cleaning agents or abrasives on the interior. These cleaners may damage or discolor the interior.

Use this appliance only for its intended purpose as described in this *Instruction Manual*.

Keep fingers out of the "pinch point" areas. Clearances between the door and cabinet are necessarily small. Be careful closing door when children are in the area.

## **DANGER**

### ***Risk of child entrapment!***

Child entrapment and suffocation are not problems of the past. Junked or abandoned appliances are still dangerous, even if they will "just sit" for a few days"

*Before discarding your old refrigerator:*

*Take off the doors*

*Leave the shelves in place so that children may not easily climb inside.*

**- SAVE THESE INSTRUCTIONS -**

# INSTALLATION INSTRUCTIONS

## BEFORE USING YOUR APPLIANCE

Remove the exterior and interior packing.

Before connecting the appliance to the power source, let it stand upright for approximately 24 hours.

This will reduce the possibility of a malfunction in the cooling system from handling during transportation.

Clean the interior surface with lukewarm water using a soft cloth.

Install the handle on the door, if it is not already attached (See page 7.)

## INSTALLATION OF YOUR APPLIANCE

Your outdoor drawers refrigerator have been designed for both built-in and free standing. When built-in, your refrigerator drawers do not require additional air space for top, side, or rear, The front grille must NOT be obstructed.

**Note:** It is recommended that you do not install the appliance near an oven, radiator or other heating source. And heat sources may increase electrical consumption. Don't install in a location where the temperature will fall below 50°F (10°C). For best performance, do not install the appliance behind a cabinet door or block the base grille.

Avoid locating the unit in moist areas.

Plug the appliance into an exclusive, properly grounded wall outlet.

## SITE PREPARATION

- 1 Position the unit on a flat, level surface capable of supporting the entire weight of the unit. Remember the unit will be significantly heavier once it is fully loaded.
- 2 Avoid connecting the unit to a Ground Fault Interruptor (GFI). GFIs are prone to nuisance tripping which will cause the unit to shut down. GFIs are generally not used on circuits which power equipment that must run unattended for long periods of time.
- 3 The unit must be installed according to your local codes and ordinances.

### 4 ELECTROCUTION HAZARD!



Electrical Grounding Required - This appliance is equipped with a three prong (grounding) polarized plug for your protection against possible shock hazards.

- NEVER remove the round grounding prong from the plug.
- NEVER use a two-prong grounding adapter.
- NEVER use an extension cord to connect power to the unit.

Where a two-prong wall receptacle is encountered or a longer power cord is required, contact a qualified electrician to have it replaced in accordance with applicable electrical codes.

# INSTALLATION INSTRUCTIONS

5 Position the unit to allow free air flow through the front grille.

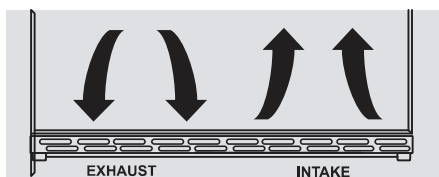

6 Wipe out inside of unit with a damp cloth.

7 Be sure to install the Anti-Tip bracket. Follow the instructions provided with the Anti-Tip bracket kit.

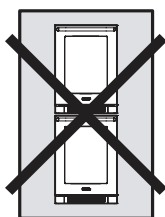

The Anti-Tip Kit must be installed on this unit before it is used. Double stacking units may cause serious personal injury.

## ANTI-TIP BRACKET INSTALLATION

To reduce the risk of tipping the unit by abnormal usage or improper loading, the appliance must be secured by properly installing the anti-tip device packed with the appliance.

- Take the fixing bracket ( 2 pcs) and screws (2 pcs) out of the instruction packet.
- Drill holes into the floor according to the dimensions shown below. This will allow you to fix the brackets to the door. (image1)
- Push the appliance into its place of installation. (image2)
- If the unit is not stable, pull out the appliance and repeat the previous step until the unit is stable.

**NOTE:** If the unit is relocated, the bracket must be removed and installed in the new location.

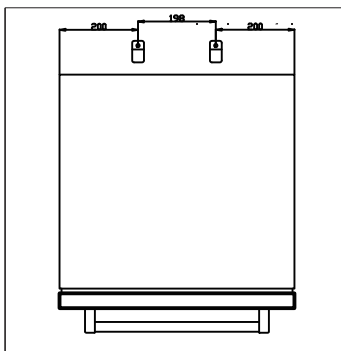

image1

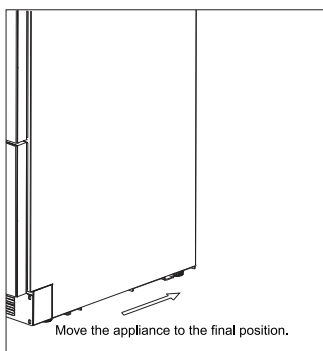
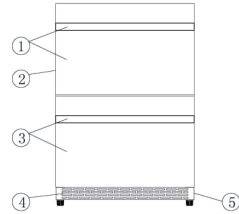

image2

# INSTALLATION INSTRUCTIONS

## NAMES OF THE PARTS

- 1 ) Upper drawer & handle
- 2 ) Cabinet
- 3 ) Lower drawer & handle
- 4 ) Exhaust grill
- 5 ) Compressor & power board (on the rear)



## SPECIFICATIONS - Model # TRZ24U

Product Description	Built-in FRIDGE		
Model No.	TRZ24U		
Unit Dimensions ( inches )	Width	Height	Depth
	23.6 "	34"	26.5"(with handle)
Net Weight ( lbs )	123lbs		

### Install the outdoor drawer refrigerator:

Your product has been designed built-in or free standing installation.

Cutout Dimensions

Dimensions of the recess

Height of housing	34.4 In	875mm
Depth of housing	24 In	610mm
Width of housing	24 In	610mm

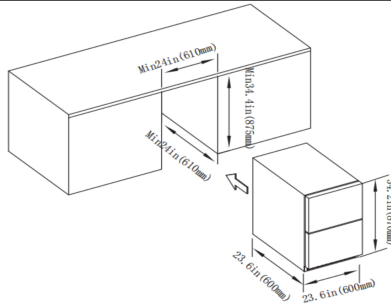

Attention: The ventilator should not be covered, or it will cause unpredictable breakdown; the fan and the return-airway should not be covered, too, or it will cause the temperature of the wine cooler couldn't reach the setting temperature, and the temperature of the cabinet is uneven.



# INSTALLATION INSTRUCTIONS

## LEVELING THE UNIT

Position the unit on a flat, level surface capable of supporting the entire weight of the unit when full.

This unit contains four (4) adjustable leveling legs. Turn the legs clockwise to raise and counterclockwise to lower.

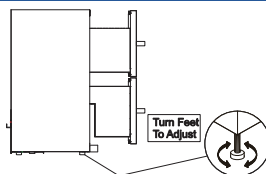

## INSTALLING HANDLE

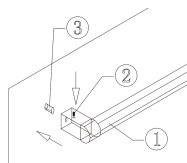

Locate the handle(1) over the pins(3) of the door and tighten the handle by screwing the Allen key grub screws(2).

## ELECTRICAL CONNECTION



### WARNING

Improper use of the grounded plug can result in the risk of electrical shock. If the power cord is damaged, have it replaced by a qualified electrician or an authorized service center.

This appliance should be properly grounded for your safety. The power cord of this appliance is equipped with a three-prong plug which mates with standard three-prong wall outlets to minimize the possibility of electrical shock.

Do not under any circumstances cut or remove the third (ground) prong from the power cord supplied. For personal safety, this appliance must be properly grounded. Any questions concerning power and/or grounding should be directed toward a certified electrician or an authorized service center.

This appliance requires a standard 115/120 Volt AC ~60Hz three-prong grounded electrical outlet. Have the wall outlet and circuit checked by a qualified electrician to make sure the outlet is properly grounded. When a standard 2-prong wall outlet is encountered, it is your responsibility and obligation to have it replaced with a properly grounded 3-prong wall outlet.

To prevent accidental injury, the cord should be secured behind the appliance and not left exposed or dangling.

The appliance should always be plugged into its own individual electrical outlet which has a voltage rating that matches the rating label on the appliance. This provides the best performance and also prevents overloading house wiring circuits that could cause a fire hazard from overheating. Never unplug the appliance by pulling on the power cord. Always grip the plug firmly and pull straight out from the receptacle. Repair or replace immediately all power cords that have become frayed or otherwise damaged. Do not use a cord that shows cracks or abrasion damage along its length or at either end. When moving the appliance, be careful not to damage the power cord.

## EXTENSION CORD

Because of potential safety hazards under certain conditions, it is strongly recommended that you do not use an extension cord with this appliance. However, if you must use an extension cord it is absolutely necessary that it be a UL/CUL-Listed, 3-wire grounding type appliance extension cord having a grounding type plug and outlet and that the electrical rating of the cord be 115 volts and at least 1.3 amperes.

# OPERATING YOUR APPLIANCE

It is recommended that you install the appliance in a place where the ambient temperature is between 50°F and 100.4°F (10°C-38°C). If the ambient temperature is above or below recommended temperatures, the performance of the unit may be affected. For example, placing your unit in extremely cold or hot conditions may cause interior temperatures to fluctuate. The operating temperature range may not be reached.

## CONTROL PANEL

The setting should be operate in the control panel.

(1) Functions of each keys in the control panel.

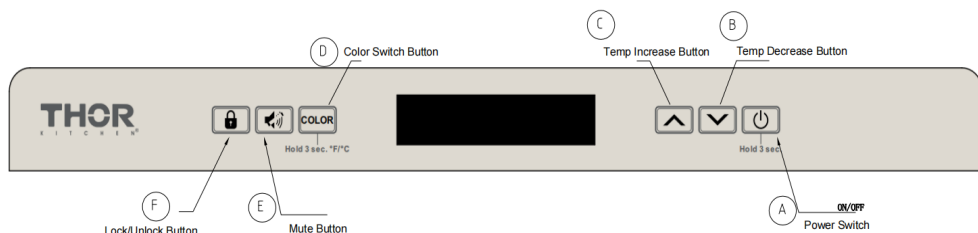

A. Power Switch: After plug in the power cord, press power switch for 1 second, appliance will power on. To turn off the appliance, press power switch and hold it for 3 seconds, appliance will power off.

B. Temp Decrease Button: Used to lower (cool) the set temperature by 1°C or 1°F. When the screen is flashing, press it once, the temperature setting is down by 1°C or 1°F, the lowest setting temperature is -18°C (0°F).

C. Temp Increase Button: Used to raise (warm) the set temperature by 1°C or 1°F. When the screen is flashing, press it once, the temperature setting is up by 1°C or 1°F, the highest setting temperature is 0°C (32°F).

D. Color Switch Button:

1. Color can be switch to white or blue by pressing the button for once.
2. Press and hold the button for 3 seconds can switch the temperature display setting in Fahrenheit or Celsius degree.
3. Lights would on when the drawer has been opened.

E. Mute Button:

1. Mute the alarming voice by press the button once.
2. Mute the pressing voice by press and hold the button for 3 seconds.

F. Lock/Unlock Button: Press and hold for 3 seconds can lock or unlock the appliance.

Lock or unlock will show on the screen. Appliance will lock automatically when the appliance doesn't have any move in 1 minute.

(2) There is automatic storage memory when power off in this wine cooler, that means the setting temperature is memories automatically even in power off, so the setting temperature is the same as last setting when the wine cooler is running again.

(3) Defrosting

The unit defrosts automatically.

The evaporator behind the rear wall of the unit defrosts automatically. The condensate collects in the drainage channel behind the rear wall of the unit, and flows through the drainage hole into the drip tray by the compressor where it evaporates. When the wine cooler run for some time, the wine cooler will enter to defrosting, the compressor stop running and the fan will keep running. The temperature will up to about 5°C when defrosting, then keep on running normally; It takes more time for the temperature to come up to 5°C when the setting temperature is low (for example the setting temperature is 1°C), and there are full of wines in the cabinet, and this is not a breakdown.

# CARE AND MAINTENANCE

## ALARM AND ERROR CODE

1. Door Alarm: Internal fans will turn off once the doors were opened.

Alarm will start to sound when doors has been opened over 60 seconds.

However, if the noise disturbs you, you can turn off alarm by pressing Button E which is the Mute Button , but the screen will keep flashing. Compressor and internal fans will stop working after doors were opened over 60 seconds, both compressor and internal fans will active again by doors has been closed.

Temperature Alarm: The alarm will sound and the temperature display will flash when error of temperature were happened, you can mute the alarm by pressing Mute Button, but the screen will keep flashing, there are two kinds of alarm which are shown below,

A. Low Temperature Alerting: Alarm will rang out when the temperature inside the cabinet was 4°C

lower than the setting temperature over 60 minutes. The screen will show up 'LL' and keep flashing.

B. High Temperature Alerting: Alarm will rang out when the temperature inside the cabinet was 8°C

higher than the setting temperature over 24 hours. The screen will show up 'HH' and keep flashing.

### ERROR CODE:

CODE	Error
E1	Internal temperature sensor broken circuit
E2	Internal temperature sensor short circuit
E3	Defrosting sensor which located at evaporator inside the cabinet broken circuit
E4	Defrosting sensor which located at evaporator inside the cabinet short circuit
Normal Flashing	Door open alarm
HH	High temperature alarm
LL	Low temperature alarm

Caution: Compressor, Fans and Defrosting System will shut down when the screen showing E1 or E2. For E3 or E4 are different, compressor and fans will shut down for 5 minutes when E3 or E4 show up, compressor and fans would back to work after 5 minutes.

## CLEARING AND MAINTAINING YOUR APPLIANCE

Periodic cleaning and proper maintenance will ensure efficiency, top performance, and long life.

The maintenance intervals listed are based on normal conditions. You may want to shorten the intervals if you have pets or other special considerations.

Exterior Cleaning for Your Stainless Steel Model

- Your stainless steel model may discolor when exposed to chlorine gas, pool chemicals, salt water, or cleaners with bleach.
- Keep your stainless unit looking new by cleaning with a high quality, all-in-one stainless steel stainless steel cleaner/polish on a monthly basis. Frequent cleaning will remove surface contamination that could lead to rust. Some installations will require cleaning on a weekly basis.
- DO NOT CLEAN WITH STEELWOOL PADS.
- DO NOT USE CLEANERS THAT ARE NOT SPECIFICALLY INTENDED FOR STAINLESS STEEL (this includes glass, tile and counter cleansers).
- If any surface discolors or rusting appears, clean it quickly with Bon-Ami or Barkeepers Friend Cleanser and a non-abrasive cloth. Always clean in the direction of the grain. Always finish this process with a high quality, all-in-one stainless steel cleaner/polish to prevent further problems.
- USE OF ABRASIVE PADS SUCH AS SCOTCHBRITE WILL CAUSE THE GRAINING IN THE STAINLESS TO BECOME BLURRED.
- Rust that is allowed to linger can penetrate into the surface of the stainless steel and become impossible to remove.

# CARE AND MAINTENANCE

---



- Stainless steel models exposed to chlorine gas and moisture such as areas with spas or swimming pools, may have some discoloration of the stainless steel. Discoloration of the stainless steel. Discoloration from chlorine gas is normal. Follow exterior cleaning instructions.
- NEVER USE CHLORIDE TO CLEAN STAINLESS STEEL.

## POWER FAILURE

---

Most power failures are corrected within a few hours and should not affect the temperature of your appliance if you minimize the number of times the door is opened. If the power is going to be off for a longer period of time, you need to take the proper steps to protect the contents.

## VACATION TIME

---

**Short vacations:** Leave the appliance operating during vacations of less than three weeks.

**Long vacations:** If the appliance will not be used for several months, remove all items and turn off the appliance. Clean and dry the interior thoroughly. To prevent odor and mold growth, leave the door open slightly, blocking it open if necessary.

## MOVING YOUR APPLIANCE

---

1. Remove all items.
2. Securely tape down all loose items (shelves) inside your appliance
3. Turn the adjustable legs up to the base to avoid damage.
4. Tape the door shut.
5. Be sure the appliance stays secure in the upright position during transportation. Also protect the outside of the appliance with a blanket or similar item.

## ENERGY SAVING TIPS

---

The appliance should be located in the coolest area of the room or outdoor location, away from heat-producing appliances and out of direct sunlight.

Ensure that the unit is adequately ventilated. Never cover air vents.

Do not keep the door open any longer than necessary.

Let hot foods cool to room temperature before placing in the unit. Overloading the unit forces the compressor to run longer.

Be sure to wrap foods properly, and wipe containers dry before placing them in the unit. This cuts down on frost build up inside the unit.

Unit shelves and storage bins should not be lined with aluminum foil, wax paper or paper toweling. Liners interfere with cold air circulation, making the unit less efficient.

Organize and label stored items to reduce door openings and extended searches. Remove as many items as needed at one time, and close the door as soon as possible

# TROUBLE SHOOTING

You can solve many common problems easily, saving you the cost of a possible service call. Try the suggestions below to see if you can solve the problem before calling the servicer.

## Trouble shooting Guide

PROBLEM	POSSIBLE CAUSE	REMEDY
Appliance does not operate.	Appliance is not connected to a power supply. The appliance is turned off. Tripped circuit breaker or a blown fuse.	Connect the appliance.  Switch on the appliance Switch on circuit breaker or replace fuse.
Appliance is not cold enough.	The temperature is not set correctly. The ambient temperature could require a lower temperature setting The door was opened too often  The door was not closed completely. Door is not hermetically sealed.  The condenser is too dirty. The ventilation opening is blocked or too dusty.	Check the set temperature Set a lower temperature  Do not open the door more often than necessary. Close door properly Check the door seal and clean or replace. Clean the condenser when necessary. Clear the obstructions and clean the dust
Appliance turns itself on and off frequently.	The room temperature is higher than average A large amount of food has been added to the unit  The door is open too often.  The door is not closed completely. The door gasket does not seal properly.	Put the appliance in a cooler place.  Leave the appliance to work for a while until the set temperature has been reached. Do not open the door more often than necessary. Close door properly. Check the door seal and clean or replace
Vibrations	The appliance is not properly leveled.	Level the appliance with the adjustable feet.
The appliance seems to make too much noise	The rattling noise may come from the flow of the refrigerant, which is normal. As each cycle ends, you may hear gurgling sounds caused by the flow of refrigerant in your appliance If temperature fluctuations occur, the contraction and expansion of the inner walls may cause popping and cracking noises.	
	The appliance is not properly level.	Level the appliance with the adjustable feet.
The door will not close properly.	The appliance is not properly level	Level the appliance with the adjustable feet.
	The door was reversed and not properly installed. The gasket is dirty. The shelves are out of position.	Check the door hinge and reassemble correctly. Clean the door gasket. Check the shelves and refit correctly.

# WARRANTY

---

This product has been manufactured by Thor Group, 4651 E Airport Drive, California 91761

For Customer Service, please call (877) 288 - 8099

For the most up to date warranty and service policy, please refer to our website  
[WWW.THORKITCHEN.COM/WARRANTY-REGISTRATION](http://WWW.THORKITCHEN.COM/WARRANTY-REGISTRATION)

For in-warranty service requests, please visit our website at  
[WWW.THORKITCHEN.COM/SERVICE](http://WWW.THORKITCHEN.COM/SERVICE)

Please Note: You must provide proof of purchase or installation date for any in-warranty service requests

## Part List and Exploded Views

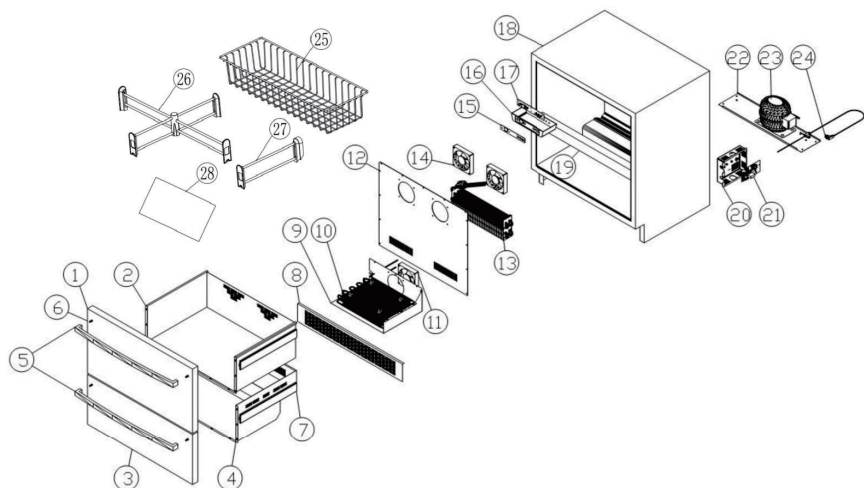

1	Upper door panel	15	Control panel Sticker
2	Upper drawer	16	Box of temperature control PCB
3	Lower door panel	17	Temperature control PCB
4	Lower drawer	18	Cabinet
5	Handle	19	Middle bar
6	Pins of handle	20	Box of power board
7	Slide rail	21	Power board
8	Exhaust grill	22	Base of compressor
9	Air duct panel of condensator	23	Compressor
10	Condensator	24	Power cord
11	AC fan	25	Wire basket
12	Air duct panel	26	On every frame
13	Evaporator	27	Under every frame
14	DC fan	28	Rubber gasket



---

For Any installation Inquiries, please call Thor Customer Service Support  
# 877-288-8099, or email to  
[info@thorgroup.us](mailto:info@thorgroup.us)



# WELCOME TO THE CLUB

You chose THOR Kitchen to enhance your culinary journey and we're stoked to have you in the club. Think of it as a secret society of really savvy people, such as yourself, choosing professional power and performance at an affordable price.



Register your product by following the steps below.

## WARRANTY REGISTRATION



01

Scan the QR code or visit  
[thorkitchen.com/warranty](https://thorkitchen.com/warranty)

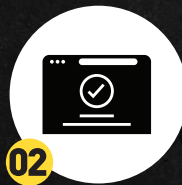

02

Input your product info  
and select register



03

You're done.  
Let's get cookin'.



For additional information and product support, visit [thorkitchen.com/service](https://thorkitchen.com/service)