

CROWN[®]

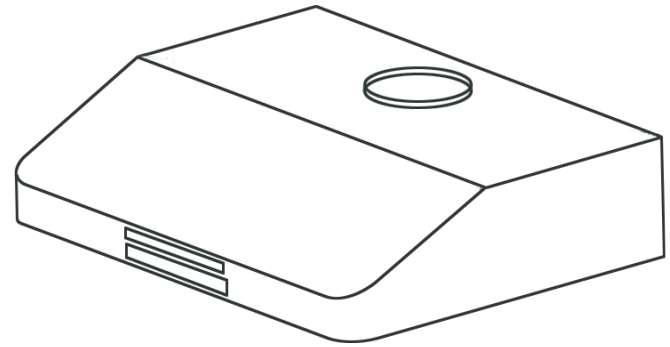

RANGE HOOD

Model No.: PRO-BF15BS

Table of Contents

Safety Information	1
Warranty	2
Pre-installation	3
Installation	7
Operation	9
Maintenance	10
Care and Cleaning	11
Troubleshooting	12

Safety Information

READ AND SAVE THESE INSTRUCTIONS FOR DOMESTIC COOKING ONLY

INSTALLER: Leave this manual with the homeowner.
HOMEOWNER: Use and Care information on Page
 If hood is to be installed Non-Ducted (Recirculation), then purchase a set of (2) non-ducted charcoal filters from your local distributor or retailer and attach them to the motor.

WARNING

SUITABLE FOR USE IN HOUSEHOLD COOKING AREA.

TO REDUCE THE RISK OF FIRE, ELECTRICAL SHOCK, OR INJURY TO PERSONS, OBSERVE THE FOLLOWING:

1. Use this unit only in the manner intended by the manufacturer. If you have the questions, contact the manufacturer at the email address or telephone number listed in the warranty.
2. Before servicing or cleaning unit, switching power off at service panel and lock service panel to prevent power from being switched on accidentally. When the service disconnecting means cannot be locked, securely fasten a prominent warning device, such as a tag, to the service panel.
3. Installation work and electrical wiring must be done by a qualified personnel in accordance with all applicable codes and standards, including fire-rated construction codes and standards.
4. Sufficient air is needed for proper combustion and exhausting of gases through the flue (chimney) of fuel burning equipment to prevent back drafting. Follow the heating equipment manufacturer's guidelines and safety standards such as those published by the National Fire Protection Association (NFPA), and the American Society for Heating, Refrigeration and Air Conditioning Engineers (ASHRAE), and the local code authorities.
5. When cutting or drilling into wall or ceiling, do not damage electrical wiring and other hidden utilities.
6. Ducted fans must always be vented to the outdoors.
7. Do not use this unit with any solid-state speed control device.
8. To reduce the risk of fire, use only steel ductwork.
9. This unit must be grounded.

TO REDUCE THE RISK OF A RANGE TOP GREASE FIRE:

- A. Never leave surface units unattended at high settings. Boil overs cause smoking and greasy spillovers that may ignite. Heat oils slowly on low or medium settings.
- B. Always turn hood ON when cooking at high heat or when cooking flaming foods.
- C. Clean ventilating fans frequently. Grease should not be allowed to accumulate on fan or filter.
- D. Use proper pan size. Always use cookware appropriate for the size of the surface element.

WARNING

TO REDUCE THE RISK OF INJURY TO PERSONS IN THE EVENT OF A RANGE TOP GREASE FIRE, OBSERVE THE FOLLOWING*:

1. SMOTHER FLAMES with a close-fitting lid, cookie sheet or metal tray, then turn off the burner. BE CAREFUL TO PREVENT BURNS. IF THE FLAMES DO NOT GO OUT IMMEDIATELY, EVACUATE AND CALL THE FIRE DEPARTMENT.
 2. NEVER PICK UP A FLAMING PAN – You may be burned.
 3. DO NOT USE WATER, including wet dishcloths or towels – This could cause a violent steam explosion.
 4. Use an extinguisher ONLY if:
 - A. You own a Class ABC extinguisher and you know how to operate it.
 - B. The fire is small and contained in the area where it started.
 - C. The fire department has been called.
 - D. You can fight the fire with your back to an exit.
- *Based on "Kitchen Fire Safety Tips" published by NFPA.

CAUTION

1. For general ventilating use only. Do not use to exhaust hazardous or explosive materials and vapors.
2. To avoid motor bearing damage and noisy and/or unbalanced impellers, keep drywall spray, construction dust, etc. off power unit.
3. For the best capture of cooking impurities, your range hood should be mounted so that the top of the hood is 26"-30" above the cooking surface (min 26" for electric cooktop, 28" for gas cooktop). The minimum hood distance above cooktop must not be less than 26"; any installation less than 26" may cause over heat and cause damage to the range hood. Chef does not warrant this improper installation.
4. Two installers are recommended because of the larger size and weight of this hood.
5. To reduce the risk of fire and to properly exhaust air, be sure to duct air outside – Do not exhaust air into spaces within walls and ceiling or into attics, crawl space or garages.
6. Because of the high exhausting capacity of this hood, you should make sure enough air is entering the house to replace exhausted air by opening a window close to or in the kitchen.
7. Use with approved cord-connection kit only.
8. Please read specification label in product for further information and requirements.

Trouble Shooting

DANGER: Please turn off the power circuit or power breaker panel before trouble shooting this range hood. Failure to do so can cause death or serious injury to personal from the live electrical energy involved.

If your range hood has developed issues and you need troubleshooting solutions, you can get assistance from these below. If after trying you are still experiencing problems, you may need to contact a technician to assess.

Problem	Solution
My range hood won't work	<ol style="list-style-type: none"> 1. Make sure that all the power supply and wiring are connected securely. 2. Double check to see if the power breaker is on or the power supply is live. 3. Check to see that the control panel cables are connected correctly to the switchboards.
The range hood vibrates when the fan is operating	<ol style="list-style-type: none"> 1. Check to ensure the hood is firmly secured to the wall or the cabinet. If not, you need to bolt it tightly to the cabinet or wall to prevent vibrations. 2. Confirm that the motor is firmly in place and secured safely. If it is not, then you may tighten. 3. Sometimes the fan can be damaged so you need to confirm this. If it is damaged, you may need to replace it.
The fans are operating weakly	<ol style="list-style-type: none"> 1. Double check on the duct size as the effective functionality will not be possible with insufficient duct size. 2. If debris or any other particles are clogged in the duct, clean it. Also, check to make sure the mesh enclosure on the hood is receiving proper air ventilation. 3. If possible, check to see that the damper is functioning properly regarding the opening.
The fan is not working properly even though the lights are working	<ol style="list-style-type: none"> 1. Double check that the fan is not jammed or that it is not scraping any of the surfaces of the hood. 2. If the issue cannot be solved with a simple check, you may need to replace the motor as it may be defective.
Why is my vent hood malfunctioning?	<ol style="list-style-type: none"> 1. Bear in mind that the minimum distance between the cooking area and the appliance should be 24" or 30" maximum. Check to see if this is correct. 2. Make sure that the duct is not susceptible to easy wind opening. 3. If you are doing the heavy cooking or light cooking, make sure the speed is at the appropriate rate. The heavier the cooking, the greater the speed of the hood should be set. 4. Maximum air ventilation through doors and windows can be a major problem for the hood while in use. Closing the windows and doors will allow the vent to work much better. 5. As noted, during the installation process, all duct works must be effectively done to eliminate the risk of developing problems. You may reduce the length of the ductwork or alter it in any other POSSIBLE way to fix the issue. Also, make sure all joinery are sealed and secured properly.
My light is not working well	<ol style="list-style-type: none"> 1. If you have a faulty light, check to see if it is loose and needs to be tightened. 2. If tightening does not fix the problem, try replacing the defective bulb with a new one and see if that solves the issue. 3. If replacement and/or tightening does not solve, you may need to replace the lighting service system on the hood.

Care and Cleaning

This range hood has an excellent durability period with proper care; it can last in performance and appearance. Here are a few do's and don'ts for caring for your range hood.



WARNING: Failure to maintain basic standards of care and cleaning of the range hood will increase the risk of fire.

Do

- Proper cleaning of the range hood involves the use of warm or close to hot soapy water and clean with a gentle cloth.
- Clean the hood in line and direction of the original polish line on the hood.
- After soap cleaning, rinse the hood properly with clean water 2-3 times and gently wipe with a soft, clean cloth.
- You can use a non-abrasive stainless steel polish for a finer touch if desired.
- If there is venting systems installed, check on a regular basis to ensure it is not clogged or has debris.

Do Not

- Do not clean the hood with abrasive or detergents containing corrosive agents. Please avoid detergents with elements such as chloride, iodide, fluoride and some other agents. These will only damage the hood surface materials.
- Do not leave soaps or other detergents on the hood for too long. The agents will only damage the product material. You need to rinse as soon as possible with clean water.
- Do not leave the hood dirty for too long as the dirt particles will easily damage the different sections of the hood.
- Do not let particles especially construction types enter the hood. When mass cleaning or renovating, ensure you cover the hood properly to reduce elements lodging in the hood.
- Cleaning agents such as alcohol and other flammable agents should not be used near the range of the stove as these may cause explosions.

Warranty

This range hood is warranted to the original purchaser to be free of defects in material and workmanship for two(2) years from the date of purchase. Our obligation shall be limited to the repair or replacement of a unit (at our discretion) that may prove, by our sole examination, to be defective under normal use and service during the warranty period. We may issue credit in the amount of the invoice value of the defective product (or a percentage of it according to use) in lieu of repair or replacement. Any failure of this product that is not traceable to a defect in material or workmanship is not covered by this warranty. These non-warrantable items include, but are not limited to:

- Any defects or damage to light bulbs
- Change in color or finish due to chemical usage
- Improper installation not in accordance with the instructions
- Dents, bumps, and scratches incurred during shipping, handling, or installation
- Damage caused by failure to follow care and cleaning guidelines, including damage caused by the use of abrasive cleaners
- Alterations made to the unit by the purchaser or installer
- Damage caused by accidental impact, fire, flood, freezing, and normal wear
- Bends and warping caused by forced connections, over-tightened fittings, and inadequate support during installation

A thorough inspection must be made before installation and any damage must be promptly reported. We will not be liable for failures or damage that could have been discovered or avoided by proper inspection and testing prior to installation.

Incidental repairs that would involve a minimum of time and effort on behalf of the purchaser will not be considered warranty work and no compensation will be deemed forth coming.

This warranty is non-transferable and shall be voided if the unit is removed from its initial installation or if it is not installed following the instructions.

Under no circumstance shall we be held liable for personal injury or property damage resulting from improper installation or use of this product. We will not be held liable for inconvenience caused by loss of use of this product, costs incurred for labor or materials, removal and installation of replacement units, or any other incidental or consequential damages. Costs relating to obtaining access for repair or replacement are the responsibility of the user.

This warranty does not extend to commercial and institutional installation or use.

WARRANTY CLAIM PRODEDURE

If a claimable defect occurs, please contact our customer service team at

Before you make your claim call, please ensure that you have:

- Description of the range hood
- Proof of sale
- Details regarding the defect
- Name(s) and address(es) of the owner and installer

Claims must be filled out in writing and returned within six (6) months of the appearance of a defect. Failure to comply with this stipulation will make this warranty null and void. We reserve the right to a thirty-day (30) delay following the receipt of a claim in which to inspect the product. We assume no responsibility for labor costs, removing or replacing a previously installed product, transportation, or the return of a product.

Pre-installation

TOOLS REQUIRED



Measuring tape



Level



Utility knife

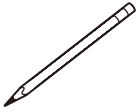

Pencil



Tape



Adjustable wrench



Phillips screwdriver



Flathead screwdriver



Needle nose pliers



Hammer



Electric drill



Safety goggles



Safety gloves

HARDWARE EXAMPLE

 **NOTE:** Hardware not shown to actual size.



Part	Description	Quantity
AA	Under cabinet mounting screws	4
BB	Outlet adapter mounting screws	3

Maintenance

STAINLESS STEEL GREASE BAFFLE FILTER

Maintenance is important for an effective functioning appliance. Here are a few maintenance tips to consider:

- Cleaning the grease filters frequently, such as every two weeks or more so after heavy use. You can use a warm detergent mixture for efficient grease cleaning.
- Baffle filter and Aluminum filter are easy to clean and are dishwasher safe.

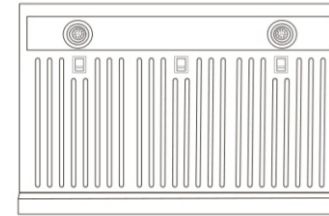

How to clean:

1. Disengage the baffle filter or aluminum filter from the hood by pull the lever and slowly take the filter down.
2. Clean the filters with a warm detergent solution carefully without bending and then set to dry before putting it back.
3. Reinstall the baffle filters.

LIGHTING

Lamp Replacements

Ask your dealer or visit our website to buy the latest version of LED

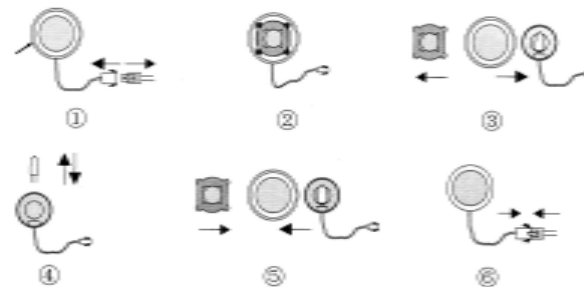

Operation

1.This hood can be manually operated with a front control panel with features such as 6-speed setting,lamp and delay shuto .



- (1) **Off/On**
Touch Off/on button, then touch speed button the hood will start operation.If you touch Off/on button again the hood will automatically turn off after 60 seconds. By touch third time to stop operation. immediately.
- (2) **Adjust "+" of the speed**
When hood is operation,touch speed "+" to increase the fan speed
- (3) **Adjust "-" of the speed**
When hood is operation,touch speed "-" to reduce the fan speed
- (4) **Light**
This range hood offers LED LampBy touching the light button. to turn on/off the light, two level is available..
- (5) **Delay**
When the hood is operation touch"Delay" button to enter delay setting mode, Press speed "+" and speed "-"button to set the min, 9 min is available to set.
- (6) **Hand Wave Lock**
When the hood off operation touch "Hand wave lock" button to start Hand wave mode



CAUTION: Unplug or disconnect the appliance from the power supply before servicing.



CAUTION: The unit is for general ventilating use only. Do not use to exhaust hazardous or explosive materials and vapors

Pre installation (continued)

PACKAGE CONTENTS

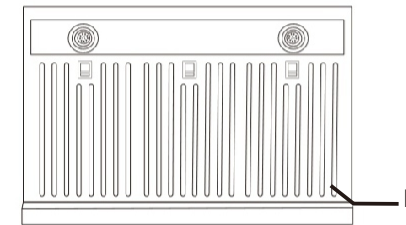
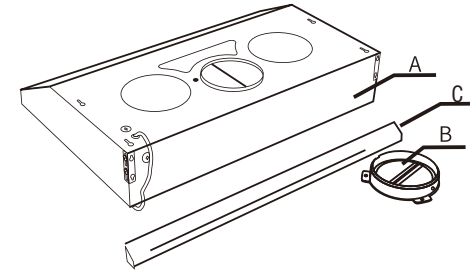

Part	Description	Quantity
A	Range hood	1
B	Vertical round outlet adapter	1
C	Stainless Steel Oil Tray	1
D	Baffle filters	3

Pre installation (continued)

SPECIFICATIONS

Dimensions	Volts	Hertz	Fan CFM	Speeds	Light Wattage	Stainless Steel Grade
755mm(29.7")	120	60	800	6	3Wx2	430
560mm(22")						
176mm(6.9")						

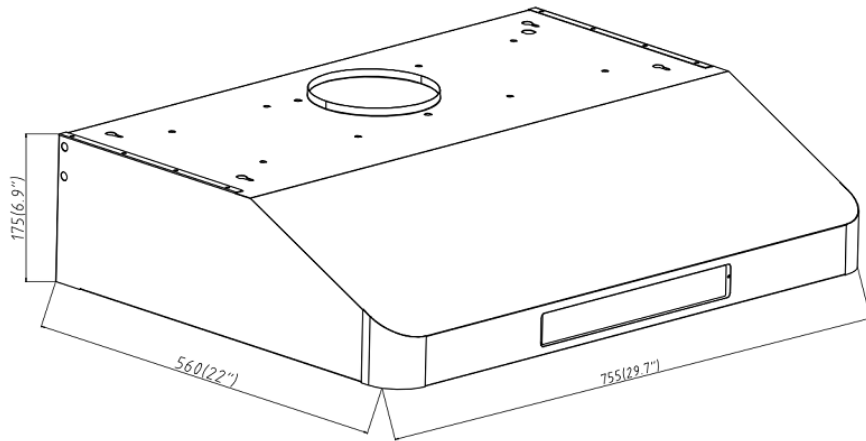

Installation (continued)

Venting Requirements:

- Hold the hood in position under the cabinet. For ducted installation, ensure that the outlet adapter enters ductwork and the damper opens and closes freely; otherwise it would greatly impact the hood's performance such as lower suction power and louder operation.
- As far as venting is concerned, decide a suitable location of the venting pipe from the hood to outside by having a straight, short vent run.
- Try to use aluminum ducts with a uniform size and try to avoid any elbows and if at all an elbow is required, a minimum of 12" straight run is imperative before the elbow.

Clearance:

- Clearance is related to the distance between cook top and bottom of the range hood and it should be in the range of 24" to 30". For gas range, the required distance is 30".
- Clearance is very important because installing below the range may result in some hazard/fire and installing above the range would decrease the overall performance.

Hood Installation:

- For the hood installation, remove all the protective layers from the hood.
- From the bottom of the hood, carefully place the screws in each of the pre-drilled mounting holes. Be sure that the hood is bolted to the cabinet before removing support.

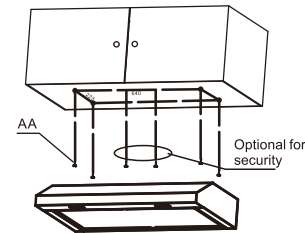

Ductwork:

- After the hood is properly fixed, attach a pipe onto the hood exhaust.
- Then tighten the joint with the aluminum foil and ensure that it is thoroughly airtight.

Electrical Work:

- Plug the power cable to a pre-installed duplex outlet.

Final Steps:

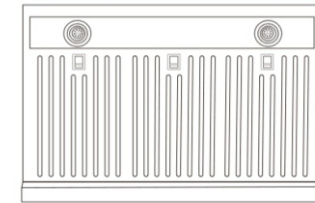

- Reinstall the baffle filters or Aluminum filter
- Keep and store this manual

Installation

CONNECTION

This appliance can be installed in ducting version only.

DUCTING VERSION

The duct and the roof/wall cap should be sourced locally.

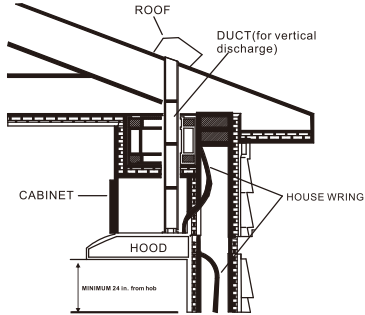

Determine whether the hood discharge vertically round (6 in.)
For vertically run ductwork between the hood location and the roof cap or wall cap. For the best result, use a minimum number of transitions and elbows.

WARNING: To reduce the risk of fire, use only metal duct work.

INSTALLATION

This INSTALLATION primarily consists of Preparation, Venting Requirements, Clearance, Hood Installation, Ductwork, Electrical Work and Final Steps.

Preparation:

1. If you need to remove the range, be sure to turn off the range's power from the main switch. Turn off the main gas supply in case it is a gas range.

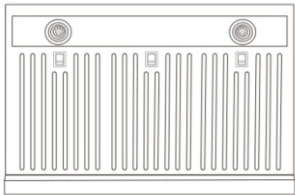

2. Remove the baffle filters or Aluminum filter by pulling the level out and slowly remove them from the range hood.

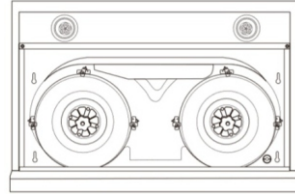

3. Duct installation:
Vertically Discharge:
Attach round(6 in.)outlet adapter and securely fasten the adapter with two screws.

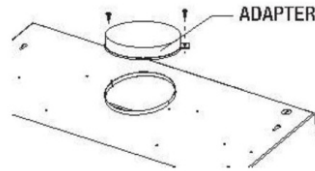

4. Measure the size of the outlet adapter relative to the cabinet and create an opening in the cabinet to let pass the outlet adapter and power cable. Make sure there is excess opening to accommodate electrical wires and hood exhaust. If you are installing the hood under the cabinet with a recessed bottom, it is advised to use a 4" wood fillers on both the sides.

Pre installation (continued)

PLANNING INSTALLATION

Before proceeding to install, please make sure you thoroughly inspect the range hood for any possible damages or missing parts. If you identify that there are missing or damaged parts, we advise you to contact the relevant personnel as soon as possible to have the issues rectified. We also strongly recommend that you are completely satisfied with the item before you dispose of its packaging. In addition, we recommend testing the range hood by establishing a temporary connection to an outlet and turn on the fan and lights.

Please note:

If you fail to read instructions carefully on how to install effectively, we will not be responsible for any damages incurred on your part.

We highly recommend reading this manual carefully before proceeding to install or using the range hood.

You should use this range hood in duct mode only, meaning allowing to duct fume to the outside at all times.

We recommend hiring a certified technician to complete the installation of this range hood.

Please check to ensure the main voltage is in line with the required voltage outlined on the rating plate inside the hood.

You need to check the domestic power supply to guarantee adequate earthing before installation.

Do not connect the range hood to any form of exhaust ducts carrying combustion fumes such as fireplaces, boilers or any similar items.

While using the hood with non-electrical appliances, you provide adequate clean air ventilation. Adequate and clear ventilation eliminates or reduces the backflow of exhaust gas to penetrate the area.

The minimum clearance between the cooking surface and the bottom of the range hood is between 24" and 30". However, the distances do vary for some appliances such as those with gas hobs which **MUST** be followed precisely. Do not exceed the maximum height of 30" while in operation.

Carefully remove the plastic protective film from the surface of the stainless hoods before installation.

CAUTION: Please hire a certified technician for installation to eliminate the risks of fires or electrical shock. Since the hood has sharp edges, it is highly recommended to use safety gloves. Make sure to avoid damage to the hood when using electrical screwdriver. In order to avoid malfunction, ensure that no debris enters the opening vent.

NOTE: The appliance may require two or more persons during the installation as it carries weight which may cause physical injuries if worked on alone.