



# **USER'S OPERATION MANUAL**

## **ARF3601**

Before operating this unit, please read this manual thoroughly, and retain it for future reference.

 [www.afg-corp.com](http://www.afg-corp.com)

# Table of Contents

Brief Introduction .....	2
Important Safety Instructions .....	3
Installing Your New Appliance.....	5
Description of the Appliance.....	11
Display Controls.....	12
Using your Appliance.....	14
Cleaning and Care .....	18
Helpful Hints and Tips .....	20
Trouble Shooting .....	21
Disposal of the Appliance.....	23

## Brief Introduction

**Thank you for your choosing Crown. We are sure you will find your new refrigerator a pleasure to use. Before you use the appliance, we recommend that you carefully read through these instructions, which provide details about installing and using the product.**

- Please ensure that everyone using this appliance is familiar with its operation and safety features. It is important that you install the appliance correctly and pay careful attention to the safety instructions.
- We recommend that you keep this user's manual with the appliance for future reference.
- This appliance is intended to be used in households and similar applications such as:

Kitchen areas in shops, offices and other working environments.

Hotels, motels and other residential environments.

Bed and breakfast environments.

Catering and similar non-commercial applications.

- This appliance is not intended for use by persons (including children) with reduced physical, sensory or mental capabilities, or lack of experience and knowledge, unless they have supervision or been given instruction concerning use of the appliance. Children should be supervised to ensure that they do not play with the appliance.
- Do not store explosive substances such as aerosol cans with a flammable propellant in this appliance.



### WARNING

- Connect to potable water supply only.
- Do not use mechanical devices or other means to accelerate the defrosting process, other than those recommended by the manufacturer.
- Do not damage the refrigerant circuit.
- Do not use electrical appliances inside the food storage compartments of the appliance, unless they are of the type recommended by the manufacturer.
- When disposing of the appliance do so only at an authorized waste disposal center. Do not expose to flame.
- If the power cord is damaged, it must be replaced by the manufacturer, its service agent or similarly qualified persons in order to avoid a hazard.
- Keep ventilation openings, in the appliance enclosure or in the built-in structure, clear of obstruction.

# Important Safety Instructions

## General safety and daily use

---

**It is important to use your appliance safely. We recommend that you follow the guidelines below.**

**Store any food in accordance with the storage instructions from the manufacturer.**

- Don't try to repair the appliance yourself. It is dangerous to alter the specifications or modify this product in any way. Any damage to the power cord may cause a short circuit, fire or electric shock.
- Don't place too much food directly against the air outlet on the rear wall of both the refrigerator and freezer compartment, as it may affect important air circulation.
- Don't place hot items near the plastic components of this appliance.
- Frozen food must not be refrozen once it has been thawed out.
- Don't store bottled or canned drinks (especially carbonated drinks) in the freezer compartment. Bottles and cans may explode.
- Use caution consuming popsicles or ice cubes straight from the freezer as this can cause freezer burn to the mouth and lips.

## Safety for children and other persons

---

- Keep all packaging away from children to avoid risk of suffocation.
- Protect children from being scalded by touching the compressor at the rear bottom of appliance

- Don't place items on top of the appliance as this could cause injury should they fall off.
- Never allow children to play with the appliance by hanging or standing over or on the doors, racks, shelves and drawers etc.

## Electrical Safety

---

**To avoid the risks that are always present when using an electric appliance, we recommend that you pay attention to the instructions about electricity below.**

- Unpack and check through the appliance. Should any damage be evident, don't plug in the appliance and contact the dealer from which you purchased it immediately. Keep all packing materials in this case.
- We recommend that you wait for 4 hours before connecting the appliance to allow the refrigerant to flow back into the compressor.
- The appliance requires single phase alternating current of 110~115V/60Hz. If the voltage fluctuates exceeding the upper limit, an A .C. automatic voltage regulator of more than 350W should be applied to the refrigerator for safe use.
- The power plug must be accessible when the appliance is installed.
- This appliance must be grounded.
- This appliance is fitted with a plug, in accordance with local standard. The plug should be suitable for use in all houses fitted with sockets in accordance with current specifications.

- If the fitted plug is not suitable for your socket outlets, it should be cut off and carefully disposed of. To avoid a possible shock hazard, do not insert the discarded plug into a socket. If in doubt contact a qualified, registered electrician.
- Do not use extension cords or multiple sockets which could cause overloading of wiring circuits and could cause a fire. Always plug your appliance into its own individual electrical socket with a voltage rating that matches the appliance's rating plate.
- Make sure that the plug is not squashed or damaged. Otherwise, it may cause short circuit, electric shock or overheat and even cause a fire.
- Do not insert the power plug if the socket is loose, there is a risk of electric shock or fire.
- Switch off the appliance and disconnect it from the main power before you clean or move it.
- Never unplug the appliance by pulling on the electrical cord. Always grip the plug firmly and pull straight out from the socket to prevent damaging the power cord.
- Do not operate the appliance without the cover on the interior lighting.
- Any electrical component must be replaced or repaired by a qualified electrician or authorized service engineer. Only genuine replacement parts should be used.
- Do not use electrical appliances such as ice cream makers inside the food storage compartments of the appliance unless they are approved by the manufacturer.

- To avoid eye injury, do not look directly into the LED light located in the refrigerator compartment. If it is not functioning correctly, consult a qualified, registered electrician or replace it in accordance with the "Cleaning and Care" chapter.

## Refrigerant

---

- The refrigerant isobutane (R600a) is contained within the refrigerant circuit of the appliance. During transportation and installation of the appliance, ensure that none of the components of the refrigerant circuit become damaged. The refrigerant (R600a) is flammable.

## Caution: Risk of Fire

---

- Don't store products which contain flammable propellants (e.g. spray cans) or explosive substances in the appliances.

### Should the refrigerant circuit be damaged:

- Avoid open flames (candles, lamps etc. ) and other sources of ignition.
- Thoroughly ventilate the room in which the appliance is situated.

### This appliance is intended to be used in household and similar applications such as:

- Staff kitchen areas in shops, offices and other working environments;
- Farm houses and by clients in hotels, motels and other residential type environments;
- Bed and breakfast type environments;
- Catering and similar non-retail applications.

# Installing Your New Appliance

Before using the appliance for the first time, you should be informed of the following tips.



## WARNING

For proper installation, this refrigerator must be placed on a level surface of hard material that is the same height as the rest of the flooring. This surface should be strong enough to support a fully loaded refrigerator.

The rollers, which are not casters, should be only used for forward or backward movement. Moving the refrigerator sideways may damage your floor and the rollers.

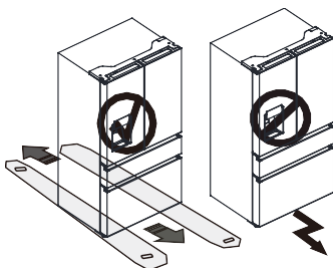

## Ventilation of appliance

**In order to improve efficiency of the cooling system and save energy, it is necessary to maintain good ventilation around the appliance for the dissipation of heat. For this reason, sufficient clear space should be available around the refrigerator.**

### • Suggestion:

It is advisable for there to be at least 2" (50mm) of clearance from the back of the fridge to the wall, at least 1/2" (12mm) of clearance from its top, at least 1/2" (12mm) from its side to the wall, and a clear space in front to allow the doors to open 125°, as shown in the following diagram.

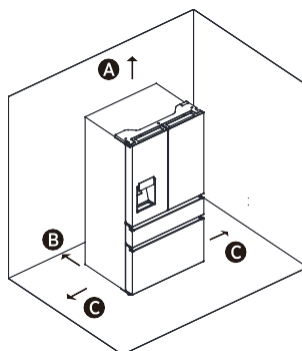

- A** 1/2" Above
- B** 2" Behind
- C** 1/2" Each Side

### Note:

- This appliance performs well within the climate class from N to T shown in the table below. It may not work properly if left at a temperature above or below the indicated range for a long period.

Climate class	Ambient temperature
SN	+50°F to +90°F
N	+61°F to +90°F
SN	+61°F to +100°F
T	+61°F to +109°F

- Stand your appliance in a dry place to avoid high moisture.
- Keep the appliance out of direct sunlight, rain or frost. Stand the appliance away from heat sources such as stoves, fires or heaters.

## Adjusting Door Height and Door Gap

The height of a door can be adjusted using the provided Snap Rings.

### Tools you will need:

	
Snap Ring (4pcs)	Wrench(Not provided)

### To adjust the Height of Door

1. Check the height difference between the doors and then lift and hold the lowest door to be even with the other.
2. Insert a suitably sized Snap Ring between the Door and the Hinge as shown.

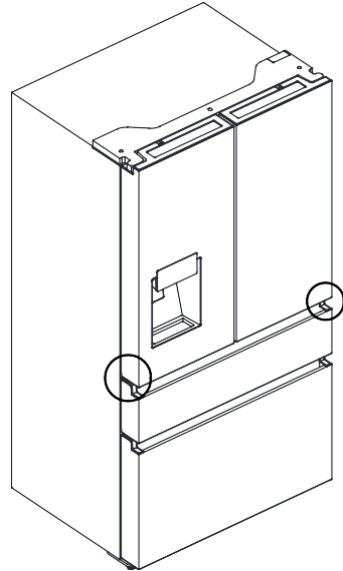
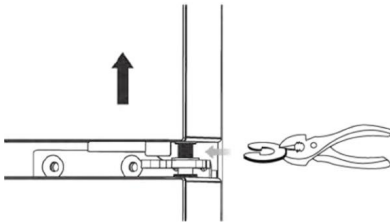

### **IMPORTANT !**

1. Insert only one Snap Ring. If you insert two or more Snap Rings, they may slip out or cause a rubbing noise.
2. Do not raise the door too much. The door may contact and damage the top cover.
3. Save remaining Snap Rings for possible future use.

### **WARNING!**

Contains Small Parts, Keep the Snap Rings Away From Babies and Children.

## Leveling of appliance

- For sufficient leveling and air circulating in the lower rear section of the appliance, the bottom feet may need to be adjusted. You can adjust them manually by hand or by using a suitable tool.
- To allow the doors to self-close, tilt the top backwards by 0.4" - 0.6" (10 - 15mm).

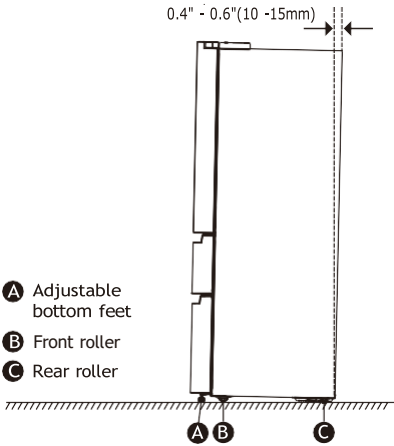

- A** Adjustable bottom feet
- B** Front roller
- C** Rear roller

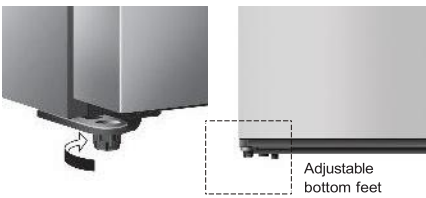

## Door Removal

- In case your home access door is too narrow for the refrigerator to pass through, remove the refrigerator doors and drawers. If you do not need to remove the appliance doors, proceed to "Installing Water Lines" on page 9. If you need to remove the doors, continue below.

### Tools you will need(Not provided)

Allen Wrench (5/32", 4mm)	Wrench (5/16", 8mm)
Phillips Screwdriver	

**! WARNING!**

**Electrical Shock Hazard**

Disconnect power before removing doors. Reconnect ground wire before operating. Failure to do so could result in death or electric shock.

- **IMPORTANT:** Keep the refrigerator doors closed until you are ready to lift them from the cabinet.
1. Unplug refrigerator or disconnect power.
  2. Using a Phillips screwdriver, remove the three screws(A) attaching the hinge cover, and then remove the hinge cover with the entire harnesses attached.

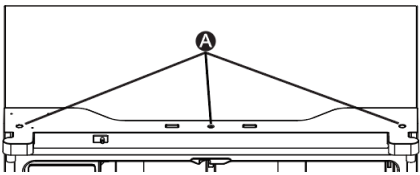

3. Separate the two connectors on the left side door. To remove the wire connector, press the top of the connector (B) and separate it from the other one. To remove the water coupler from the hinge, twist and pull the clips from the coupler. Remove the water line (C) while pressing the movable part (D) of the water line coupler.

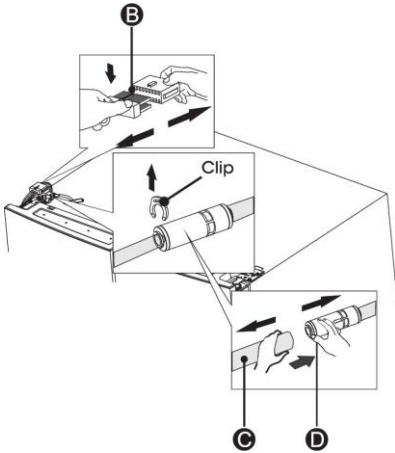

4. Remove the 3 screws (E) fixed on the hinges, with a Wrench (8mm) and 1 ground screws (F) attached to the hinge with Philips (+) screwdriver. Remove the upper left door hinge (G).

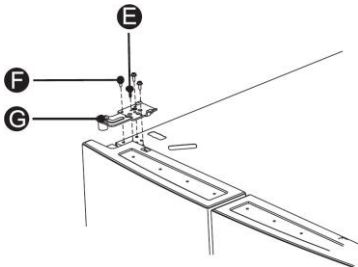

5. Use our both hands to open the door more than 90°. Lift it up and take it off.

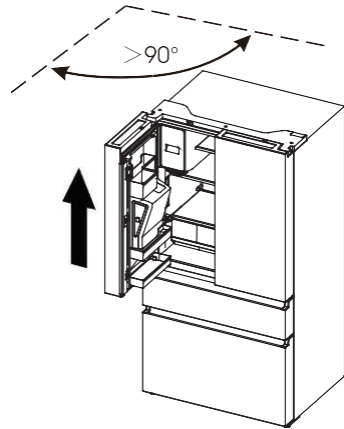

6. If necessary, remove the 2 hex head bolts hinges (I) with an Allen wrench (5 mm). Remove the lower left door hinge (H).

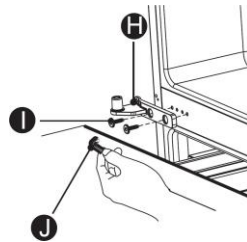

## Replace the Doors

1. If removed, reinstall the bottom hinge.
2. Using two or more people, set the refrigerator door onto the bottom hinge.
3. Insert the top hinge into the top of the door.
4. Using the three screws removed earlier, fasten the top hinge to the top of the cabinet.

**NOTE:** Left-hand door only, replace the ground screw into the top hinge, reattach the wire harness, reconnect the water line, make sure the clips are properly connected to the coupler.

5. Repeat steps 1 through 4 to replace the opposite door.
6. Using the three screws removed earlier, reinstall the top hinge cover and control panel to the top of the cabinet.



## Installing the water lines

Ice & water dispenser with a filter is one of the helpful features on your new appliance. To help promote better health, the water filter removes unwanted particles from your water.

Please follow the below instructions carefully for correct installation.

In order for the ice & water dispenser to operate properly, a water line is required.

- the maximum inlet water pressure is 862kPa;
- the minimum inlet water pressure is 207kPa.

### **WARNING!**

The water connection must be made by a qualified plumber. Operation outside the water pressure range may cause malfunction, or severe and damaging water leaks.

Under normal conditions, a 200cc (5.75 oz.) cup can be filled in about 10 seconds.

If the refrigerator is installed in an area with low water pressure (below 30psi), you can install a booster pump to compensate for the low pressure.

### What you need to have before you begin

1. Power drill and 1/4" drill bit.
2. 1/2" or adjustable wrench.
3. Flatblade and Philips head screwdrivers.

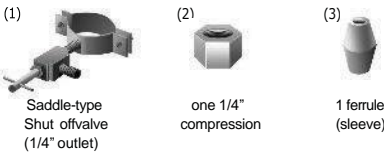

4. You may need to purchase No.1, No.2 and No.3 parts to complete this connection. You may find these items sold as a kit at a local hardware store.

## Connecting to the water supply line

1. First, shut off the main water supply.



2. Using a power drill and a 1/4" drill bit drill into the cold-water line and connect the saddle-type shutoff valve.

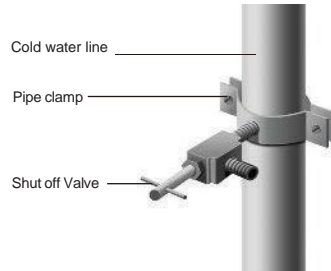

3. Connect 1/4" extension tubing to shutoff valve outlet.

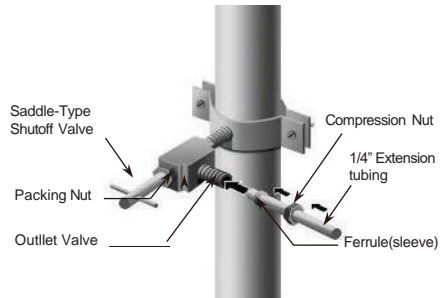

4. Flush the tubing. Turn the main water supply on and flush out the tubing until the water is clear. Then, shut the water off at the water valve after about a quart of water has flushed through the tubing.

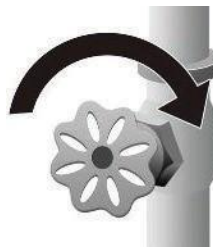

5. Connect the extension tubing line with the line on the back of the fridge via the coupler. Fully insert the extension tubing into the coupler, and then insert the clip onto the coupler to lock in the tubing. Do the same with the other end. After both clips are inserted, check the line to make sure it is held firmly by the clips.

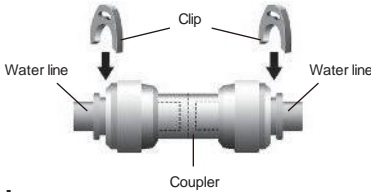

**Note:**

Ensure that the water line does not get pinched or bent when installing. This can result in improper water flow through the line and will affect the functionality of the fridge.

6. Turn the water on and check for leakage.



**Connect Water Line to Refrigerator**

**IMPROTANT:** If you turn the refrigerator on before the water is connected, turn off the ice maker.

1. You may need to purchase below items to complete this connection. And you may find these items sold as a kit at a local hardware store.

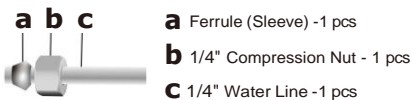

2. Unplug refrigerator or disconnect power.
3. Close shutoff value.

4. Thread a 1/4 " compression nut and ferrule (sleeve) onto the free end and of 1/4" water line.
5. Insert the free end of the 1/4" water line into the brass fitting attached to the water inlet on the back of the refrigerator.
6. Slide the 1/4" compression nut over the ferrule (sleeve) and screw the 1/4" compression nut onto the brass fitting.

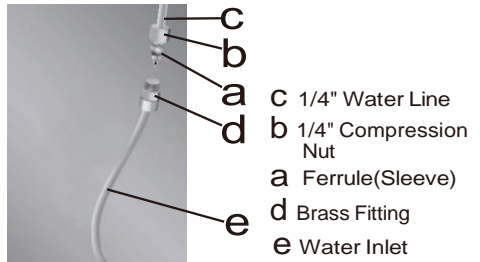

7. Confirm 1/4" water line is secure by gently pulling on it.
8. Turn on water supply and check for leaks. Correct any leaks

**Note:**

Use only the new tubing supplied with the refrigerator. Old tubing should not be used. After connected to the water supply line, please open the water valve to flush the filter for 5 minutes before use. The initial dark discoloration of water is normal.



The water line must be connected to the cold water pipe. If it is connected to the hot water pipe, it may cause the purifier to malfunction. Avoid contamination of pipes during installation. Connect to potable water supply only.

# Description of the Appliance



**A** Refrigerator LED Light

**B** Water Filter

**C** Refrigerator Door Bin

**D** Ice-Maker

**E** Rotary Separator

**F** Glass Shelf

**G** Refrigerator Side Light

**H** Storage Drawer

**I** Middle Storage Drawer

**J** My Fresh Choice Drawer

**K** Freezer Drawer

**L** Down Freezer Drawer

**M** Fridge Door Left

**N** Fridge Door Right

**O** My Fresh Choice Door

**P** Freezer Door

**Q** Leveling Leg

## Note:

- Due to unceasing modification of our products, your refrigerator may be slightly different from this instruction manual, but its functions and using methods remain the same.
- To get the best energy efficiency of this product, please place all shelves, drawers and baskets on their original position as per the illustration above.

# Display Controls

Your product has one control panel which is installed on the refrigerator door. Use your appliance according to the following control guidelines.

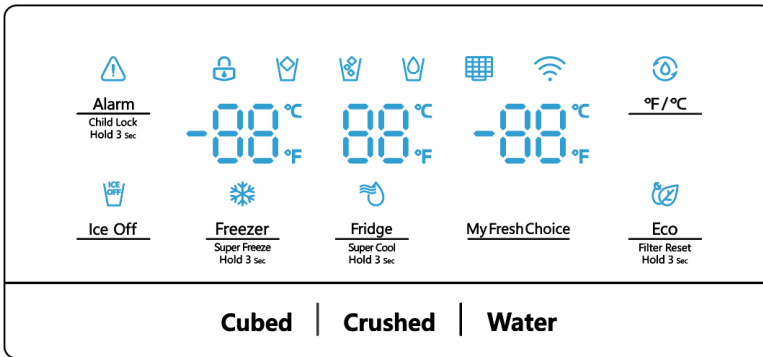

The display will illuminate when the refrigerator is first plugged in. However the lights will automatically turn off after 60 seconds.



## Child Lock and Door Alarm

This button serves two purposes:

### 1. Child Lock

Press and hold "Alarm" for 3 seconds to lock the whole Control Panel including dispenser function. If Control panel is locked, the icon  will be on, and none of the buttons on the Control panel work. To unlock the Control panel, please press and hold "Alarm" for 3 seconds again.

### 2. Door Alarm

Leaving any door open for over 2 minutes will activate door alarm. The  icon will flicker, the control panel will display "dr", and you will hear a buzzer sound. The buzzer will sound 3 times per minute and will stop after 8 minutes. In case of alarm, you can touch the Alarm button to cancel door alarm, then the  icon stops flickering and keeps on, the buzzer sound will stop at the same time. Also door alarm can be stopped by closing all the doors. To save energy, please avoid keeping doors open for a long time when using refrigerator.

## Ice Control

You can touch "Ice Off" button to control the ice maker. When the Child Lock is off, you can touch the "Ice Off" icon to lock the ice maker, and the icon  will be illuminated. If you want to unlock the ice maker, please

touch the "Ice Off" icon again, and the icon  will be off.

**NOTE:** When the "Ice Off" is on, it only locks the ice maker not the dispenser.

## Fridge Temperature Control

When you touch the button continuously, the temperature will be set in the following sequence.

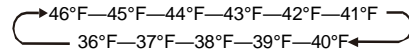

If you want to decrease the time needed to cool items in the Fridge, please touch and hold this button for 3 seconds, the Super Cool icon  will be illuminated, the fridge temperature setting will display 36°F. Super Cool automatically switches off after 3 hours, and the refrigerator temperature setting will revert back to the previous setting. When Super Cool function is on, you can touch the "Fridge" to switch it off.

**Note:** On the Super Cool Function, when you touch the "Eco" button, Eco function will be activated, and "Super Cool" mode will be off.

## Freezer Temperature Control

You can touch the "Freezer" button to activate the mode to control the freezer temperature. When you press the button continuously, the temperature will be set in the following sequence.

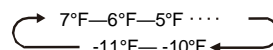

Press and hold the button for 3 seconds, the icon "❄️" will be illuminated, the freezer temperature setting will display -11°F. Super Freeze can quickly lower the temperature and freeze your food faster than usual. This can retain more of the vitamins and nutrition in fresh food and keep your food longer.

Super Freeze automatically switches off after 52 hours, and the freezer temperature setting will revert back to the previous setting.

When the Super Freeze function is on, you can touch "Freezer" to switch off the Super Freeze function.

The Super Freeze is used to perform pre-freezing and fast freezing in sequence of Freezer compartment. This function accelerates the freezing of fresh food and, at the same time, protects foodstuffs already stored from undesirable warming.



**To freeze fresh food activate the Super Freeze function at least 24 hours before placing the food to complete pre-freezing.**

**Note:** On the Super Freezer Function, when you touch the "Eco" button, Eco function will be activated, and "Super Freezer" mode will be off.

### My Fresh Choice Temperature Control

You can touch the "My Fresh Choice" button to activate the mode to control the convertible compartment temperature. When you press the button continuously, the temperature will be set in the following sequence.

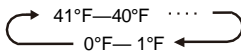

### Dispenser Control

When the Child Lock is on, the dispenser will not work. When the Child Lock is off, you can press the "Cubed" or "Crushed" option to choose the type of ice to be dispensed, and press the "Water" button will activate the water mode. If you choose the function of Cubed, the "❄️" icon will be illuminated, choose the function of Crushed the "❄️" icon will be illuminated, and the "💧" icon will be illuminated when Water function is chosen.



When the Child Lock is off, you can touch the "°F/°C" button to switch between Celsius and Fahrenheit units. The default state is Fahrenheit display. When it is switched to Fahrenheit, the icon "°F/°C" will be on.



### ECO/Energy Saving

You can touch this button to turn Energy Save mode on and off. When you turn Energy Save on, the Eco icon "🌿" lights. The temperature of the fridge is automatically switched to 43°F(6°C) and the freezer to 1°F(-17°C).

If Energy Save is off, the icon "🌿" will go off and the temperature setting will revert back to the previous setting.



### Water Filter

In general, you should change the water filter every 6 months to ensure the highest possible water quality.

After the refrigerator has dispensed about 200 gallons of water, the filter icon "📊" will blink, reminding you to replace the water filter.

You can purchase the new filter from the retailer where you purchased your refrigerator or the Crown after-sales service system. Make sure that the new filter is the same filter type that came with your fridge and can be correctly used in your refrigerator. After you change the water filter, touch and hold the "Eco" buttons for 3 seconds to make the blinking stop.

### Demo Mode

Demo mode is for store display, and it prevents the refrigerator from generating cool air. In this Demo Mode, the refrigerator may seem like it is working but it will not make cool air.

The indicators on the control panel will show "0F". To cancel this mode, touch and hold "Alarm" and "°F/°C" buttons at the same time for 3 seconds until the buzzer beep a long sound.

# Using your Appliance

## Using your fridge compartment

The refrigerator compartment is suitable for storage of vegetables and fruit. Food inside should be sealed for storage in order to avoid losing moisture or flavor permeating into other foods.

### Caution!

Never close the refrigerator door while the shelves, crisper and/or telescopic slides are extended. It may damage both them and the refrigerator.

## Opening and Closing Doors

The four doors can be opened and closed either separately or together.

- There is a mullion on the left-hand side refrigerator compartment door.
- When closing the left-hand door, the mullion folds behind the right-hand door joining the two doors.
- The temperature of the door frame is controlled to help prevent moisture from developing on the mullion. The temperature of the surface may be warm, which is normal, and will not affect the performance of the refrigerator.

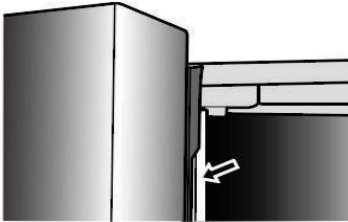

**Note:** Before closing the left-hand door, make sure the mullion is folded inward. If the mullion is pulled outward it may become damaged when you try to close the door.

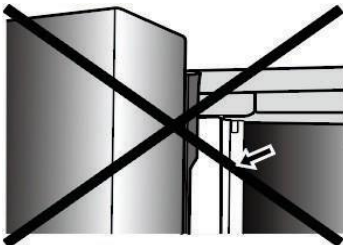

## Door Bins

The refrigerator compartment is provided with six door bins, which are suitable for the storage of canned liquid, bottled drinks and packaged food. To remove the door, simply lift the racks up and pull straight out. To relocate the door, slide it in above the desired location and push down until it stops.



### WARNING!

Do not place too many heavy things in the baskets. Before you lift up the door shelf vertically, please take the food out.

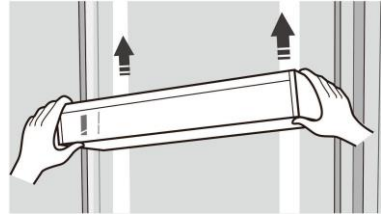

## Adjustable Shelves

The height of the shelves can be adjusted to fit your storage needs.

1. To remove the glass shelves, tilt up the front of the shelf in the direction shown (1) and lift it up vertically (2). Pull the shelf out.

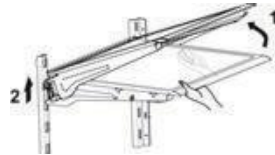

2. To re-install the glass shelves, tilt the front of the shelf up and guide the shelf hooks into the slots at a desired height (1). Then lower the front of the shelf so that the hooks can drop into the slots (2).

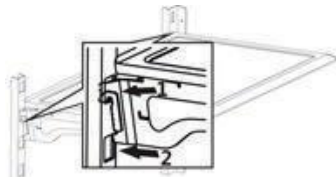

## Removing/Replacing freezer drawer

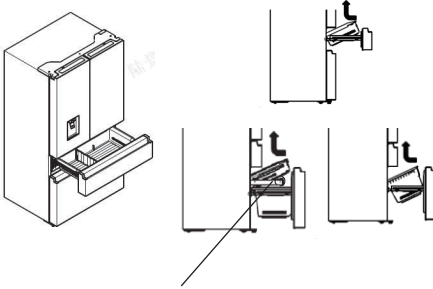

**NOTE:** Unscrew the drawer before taking it out.

1. Pull out drawer to maximum extension.
2. Lift up to remove the drawer.
3. Reverse steps 1 and 2 to replace the drawer.

## Getting Cold Water and Ice

Push the appropriate ice or water type button to select what you want to dispense.

### Getting Cold Water

The water dispenser is located in the fridge door. To get water, push the water button. Then move your glass down to the dispenser lever (A) at below suggested position and press it.

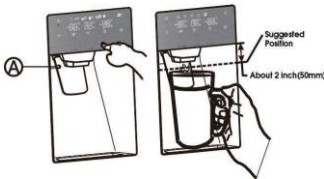

### Getting Cubed & Crushed Ice

To get ice, push the cubed or crushed ice button as required. Then move your glass down to the dispenser lever (A) at below suggested position and press it.

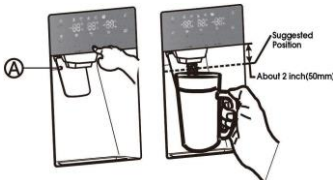
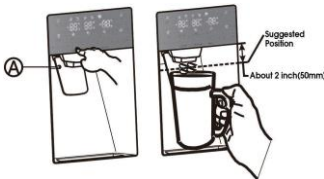

## WARNING

- If a power failure occurs, ice cubes may melt and then freeze together when the power comes back on, causing the dispenser to stop working. To prevent this problem, after a power failure, pull out the ice bucket and residual ice or water.
- Don't push the water dispenser lever forward without a cup below since it may cause water spilling.

## Ice Maker in Refrigerator

Press "Ice Off" Button to turn the ice maker On and Off. The Ice Off icon "ICE OFF" is off when the ice maker is functioning.

- Following installation, allow 24 hours to produce the first batch of ice. Discard the first three batches of ice produced. Allow 2 to 3 days to fill the ice storage container.
- If the ice in the ice container clumps or sticks to the wall, break up ice using a plastic utensil and discard. Do not use a sharp tool to break up the ice. This can cause damage to the ice container.
- Do not store any items other than ice in the ice storage container.
- If the ice sticks to the wall, break the ice cubes with plastic utensils and discard.

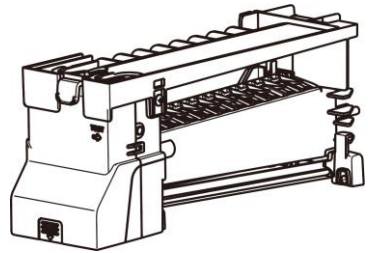

## To turn off the Ice Maker

- Press the "Ice Off" button to turn off the ice maker, the "ICE OFF" icon will light up. And you need to remove all ice cubes from the ice bucket. If not, the ice cubes may clump together, making it difficult to remove them.

## To remove the ice bucket

When you select the ice off mode, remove all ice cubes from the bucket.

1. Open the door at the maximum Angle.



2. Gently lift the ice bucket up, and then pull it out slowly while holding the bottom of the bucket with one hand and the side with the other hand.

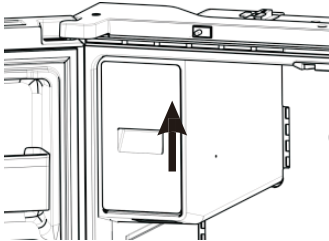

3. Empty the ice bucket.

**Note:** If you leave the ice cubes in the bucket, the ice cubes may clump together making it difficult to remove them.

4. When done, put the ice bucket back into the position, push it firmly straight back. If the ice bucket does not fit in, turn the helix 90 degree(see the below illustration on the right) and try again.

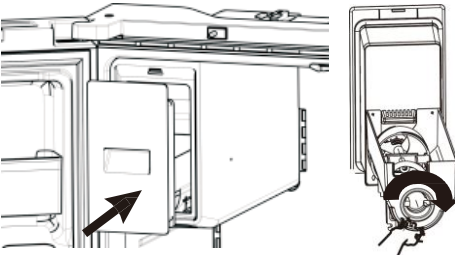

## CAUTION

- Do not apply excessive force to the bucket cover. The cover may break.
- To prevent injury, make sure to clean up any ice or water that has fallen on the floor.

- The inside of the ice bucket is very cold when the refrigerator is operating. Don't reach deep inside the ice bucket. This may cause physical injury or product damage.

## Changing the water filter

Please refer to the owner's manual for proper maintenance and operation. If this device is not maintained and operated as specified in the owner's manual, there is a risk of exposure to contaminants.

To drink the freshest and cleanest water from your refrigerator, change the filter on time.

### To change the water filter, follow below steps:

1. Shut off the water supply. Then pull the handle under the cover outwards to open the cover.



2. Pull the water filter down wards and turn it about 90° counter-clockwise to take it out. When the filter is disassembled, pay attention to keep the filter head upward tilted to avoid water leaking from the front filter part And the dropped water in the cover should be cleaned immediately.



3. Insert the new water filter into the hole, and at the same time turn it about 90° clockwise until it stops.





4. Push the water filter up, and move the cover up to horizontal and push it until it locks.

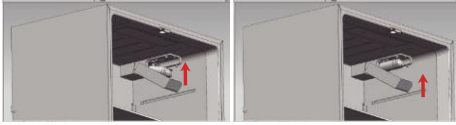

5. Turn the water supply back on.



**NOTE:** Turn the water supply back on. After that, you should check the leaks. If leaks occur, repeat the above operation steps 1-5. If leaks persist, please stop using it and call your supporting dealers.

6. Flush filter for 5 minutes before use.

## Removing any residual matter inside the water supply line

1. Turn on the main water supply and supply water from water supply line.
2. Let the water flow through the dispenser until it becomes clear (flush for approximately 5 minutes). This will clean the water supply system and remove the air from the lines.
3. Additional flushing may be required in some households.
4. Open the refrigerator door and make sure there are no water leaks coming from the water filler.

### **NOTE:**

Be sure to flush the dispenser thoroughly, otherwise water may drip from the dispenser.

This means that there is still air in the line. Do not dispense continuously. Depress and release the dispenser pad for cycles of 30 seconds ON and 60 seconds OFF.

## Reverse osmosis water supply is important:

The pressure of the water supply coming out of a reverse osmosis system going to the water inlet valve of the refrigerator needs to be between 30 and 125 psi (207 and 862 kpa). If a reverse osmosis water system is connected to your cold water supply, the water pressure to the reverse osmosis system needs to be a minimum of 40 to 60 psi (276 to 414 kpa). If the water pressure to the reverse osmosis system

1. Check to see whether the sediment filter in the reverse osmosis system is blocked. Replace the filter if necessary.
2. Allow the storage tank on the reverse osmosis system to refill after heavy usage.
3. If your refrigerator has a water filter, it may further reduce the water pressure when used in conjunction with a reverse osmosis system. Remove the water filter. Check to see whether the sediment filter.

# Cleaning and Care

**For hygienic reasons the appliance (including exterior and interior accessories) should be cleaned at least once every two months.**

## **WARNING!**

To avoid electrical shock, the appliance must not be connected to the main power supply during cleaning. Before cleaning, switch the appliance off and remove the plug from the main socket.

## Exterior cleaning

**To maintain good appearance of your appliance, you should clean it regularly.**

- Spray water onto a cleaning cloth instead of spraying directly onto the surface of the appliance. This helps ensure an even distribution of moisture to the surface.
- Clean the doors, handles and cabinet surfaces with a mild detergent and then wipe dry with a soft cloth.

## **CAUTION!**

1. Don't use sharp objects to clean with, as they are likely to scratch the surface.
2. Don't use thinner, car cleaner, bleach, oil, abrasive cleansers or organic solvent such as benzene for cleaning. They may damage the surface of the appliance and may cause fire.

## Interior cleaning

Clean the appliance interior regularly. It will be easier to clean when food stocks are low. Wipe the inside of the fridge and freezer with a weak solution of baking soda and water, and then rinse with warm water using a wrung-out sponge or cloth. Wipe

completely dry before replacing the shelves and baskets. Thoroughly dry all surfaces and removable parts before putting them back into place.



Although this appliance automatically defrosts, a layer of frost may occur on the freezer compartment's interior walls if the freezer door is opened frequently or kept open too long. If the frost is too thick, choose a time when the freezer is nearly empty and proceed as follows:

1. Remove existing food and accessory baskets, unplug the appliance from the main power and leave the doors open. Ventilate the room thoroughly to accelerate the process.
2. When defrosting is completed, clean your freezer as described above.

## **WARNING!**

Do not use sharp objects to remove frost from the freezer compartment. Only after the interior is completely dry should the appliance be switched back on and plugged back into the main socket.

## Door Seal Cleaning

Take care to keep the door seals clean. Sticky food and drinks can cause seals to stick to the cabinet and tear when you open the door. Wash seal with a mild detergent and warm water. Rinse and dry it thoroughly after cleaning.



### CAUTION!

Only after the door seals are completely dry should the appliance be powered on.

## Replacing the LED light



### WARNING!

The LED light must be replaced by a competent person. If the LED light is damaged, follow the steps below:

1. Unplug your appliance.
2. Remove the light cover by lifting up and pulling out.
3. Hold the LED light with one hand and pull it while pressing the connector latch with the other hand.
4. Replace the LED light and snap it correctly in place and replace the light cover.

## General Use Information

- When first turning on refrigerator after a period of non-use, allow the refrigerator to cool at least 2 hours before adding food.
- Do not block air circulation vents with stored items.
- Store items so that the air can circulate freely around them.
- Cover or wrap stored food well to avoid transfer of odors.
- Once defrosted, food quality will deteriorate rapidly. Defrosted food should not be refrozen.
- Neither bottled nor canned drinks should be stored in the freezer compartment. Bottles and cans may explode.

To avoid contamination of food, please respect the following instructions:

- Opening the door for long periods can cause a significant increase of the temperature in the compartments of the appliance.
- Clean regularly the surfaces that can come in contact with food and accessible drainage systems.
- Store raw meat and fish in suitable containers in the refrigerator, so that it is not in contact with or drip onto other food.
- Two-star frozen-food compartments are suitable for storing pre-frozen food, storing or making ice cream and making ice cubes.
- Two-star compartments are not suitable for the freezing of fresh food.

# Helpful Hints and Tips

## Energy Saving Tips

**We recommend that you follow the tips below to save energy.**

- Avoid keeping the door open for long periods in order to conserve energy. Ensure the appliance is away from any sources of heat (direct sunlight, electric oven or cooker etc.)
- Don't set the temperature colder than necessary.
- Don't store warm food or evaporating liquid in the appliance.
- Place the appliance in a well ventilated, humidity freeroom. Please refer to the Installing your New Appliance chapter.
- If the diagram shows the correct combination for the drawers, crisper and shelves, do not adjust the combination as this is designed to be the most energy efficient configuration.

## Hints for fresh food refrigeration

- Do not place hot food directly into the refrigerator or freezer, the internal temperature will increase resulting in the compressor having to work harder and consume more energy.
- Do cover or wrap the food, particularly if it has a strong flavor.
- Place food properly so that air can circulate freely around it.

## Hints for refrigeration

- For Meat: (all types) wrap in cling wrap and place on the glass shelf above the vegetable drawer. Always follow food storage times and use by dates suggested by manufacturers.
- Cooked food, cold dishes, etc.: They should be covered and placed on any shelf.
- Fruit and vegetables: They should be stored in the special drawer provided.

- Butter and cheese: Should be wrapped in airtight foil or plastic film wrap.
- Milk bottles: Should have a lid and be stored in the door racks.

## Hints for freezing

- When first starting-up or after a period out of use, let the appliance run at least 2 hours on the higher settings before putting food in the compartment.
- Prepare food in small portions to enable it to be rapidly and completely frozen and to make it possible to subsequently thaw only the quantity required.
- Wrap up the food in aluminum foil or cling wraps which are airtight.
- Do not allow unfrozen food to touch the food which is already frozen to avoid temperature rise of the latter.
- Iced products (ice cubes, popsicles): if consumed immediately after removal from the freezer compartment, may cause frost burns to the skin.
- It is recommended to label and date each frozen package in order to keep track of the storage time.

## Hints for the storage of frozen food

- Ensure that frozen food has been stored properly by the food retailer.
- Once defrosted, food will deteriorate rapidly and should not be re-frozen. Do not exceed the storage period indicated by the food manufacturer.

## Switching off your appliance

If the appliance needs to be switched off for an extended period, the following steps should be taken to prevent mold on the appliance.

1. Remove all food.
2. Remove the power plug from the main socket.
3. Clean and dry the interior thoroughly.
4. Ensure that all the doors are wedged open slightly to allow air to circulate.

# Trouble Shooting

If you experience a problem with your appliance or are concerned that the appliance is not functioning correctly, you can carry out some easy checks before calling for service, please see below.

## WARNING

1. Don't try to repair the appliance yourself. If the problem persists after you have made the checks mentioned below, contact a qualified electrician, authorized service technician or the shop where you purchased the product.
2. A child entrapment warning statement is included below.

## DANGER

Risk of child entrapment. Before you throw away your old refrigerator or freezer:

- Take off the doors.
- Leave the shelves in place so that children may not easily climb inside.

Problem	Possible Cause & Solution
Appliance is not working correctly	Check whether the power cord is plugged into the power outlet properly.
	Check the fuse or circuit of your power supply, replace if necessary.
	The room temperature may be too low. Try setting the refrigerator or freezer temperature to a colder level to solve this problem.
	It is normal that the freezer is not operating during the defrost cycle, or for a short time after the appliance is switched on to protect the compressor.
Odors from the compartments	The interior may need to be cleaned
	Some food, containers or wrapping may cause odors.
Noise from the appliance	<p>The sounds below are quite normal:</p> <ul style="list-style-type: none"> <li>• Compressor running noises.</li> <li>• Air movement noise from the small fan motor in the freezer compartment or other compartments.</li> <li>• Gurgling sound similar to water boiling.</li> <li>• Popping noise during automatic defrosting.</li> <li>• Clicking noise before the compressor starts.</li> <li>• Clicking noise when you get the water.</li> <li>• The motor running noises when you get ice.</li> </ul>
	<p>Other unusual noises are due to the reasons below and may need you to check and take action:</p> <p>The cabinet is not level. The back of appliance is touching the wall. Bottles or containers have fallen or are rolling.</p>
The motor runs continuously	<p>It is normal to frequently hear the sound of the motor, it will need to run more when in following circumstances:</p> <ul style="list-style-type: none"> <li>• Temperature setting is set colder than necessary.</li> <li>• Large quantity of warm food has recently been stored within the appliance.</li> </ul>

The motor runs continuously	<ul style="list-style-type: none"> <li>• The temperature outside the appliance is high.</li> <li>• Doors are kept open too long or too often.</li> <li>• After first installing the appliance or if it has been switched off for a long time.</li> </ul>
A layer of frost occurs in the compartment	Check that the air outlets are not blocked by food and ensure food is placed within the appliance to allow sufficient ventilation. Ensure that door is fully closed. To remove the frost, please refer to the Cleaning and Care chapter.
Temperature inside is too warm	You may have left the doors open too long or too frequently; or the doors are kept open by some obstacle; or the appliance is located with insufficient clearance at the sides, back and top.
Temperature inside is too cold	Increase the temperature by following the “Display Controls” chapter.
Doors can't be closed easily	Check whether the top of the refrigerator is tilted back by 0.4"-0.6"(10-15mm) to allow the doors to self-close, or if something inside is preventing the doors from closing.
The light is not working	<ul style="list-style-type: none"> <li>• The LED light may be damaged. Refer to replace LED lights in “Cleaning and Care” chapter.</li> <li>• The control system has disabled the lights due to the door being kept open too long. Close and reopen the door to reactivate the lights.</li> </ul>
Hear water bubbling in the refrigerator	This is normal. The bubbling comes from the refrigerant coolant liquid circulating through the refrigerator.
Ice is not making	<ul style="list-style-type: none"> <li>• Did you wait for 24 hours after installation of the water supply line before making ice? If it is not sufficiently cool, it may take longer to make ice, such as when first installed.</li> <li>• Is the water line connected and the water valve open?</li> <li>• Did you manually stop the ice making function? Make sure you do not set the “Ice Off” mode.</li> <li>• Is there any ice blocked within the ice maker bucket?</li> <li>• Is the water pressure less than 30psi? Install a booster pump to compensate for the low pressure.</li> <li>• Is the freezer temperature too warm? Try setting the freezer temperature lower.</li> <li>• Ice maker is not making the ice fast enough. Please wait for at least 90 minutes.</li> <li>• Remove the bucket and check if the ice clumps or sticks to the wall, break up ice using a plastic utensil and discard.</li> </ul>
Water dispenser is not functioning	<ul style="list-style-type: none"> <li>• Is the water line connected and the water valve open?</li> <li>• Has the water line been crushed or kinked? Make sure the waterline is free and clear of any obstruction.</li> <li>• Is the water tank frozen because the refrigerator temperature is too low? Try selecting a warmer setting on the display panel.</li> <li>• Check if the filter is properly installed. If it is not properly installed, the water dispenser may not work.</li> </ul>

# Disposal of the Appliance

## DANGER

It is prohibited to dispose of this appliance as household waste.

## Packaging materials

Packaging materials with the recycle symbol are recyclable.

Dispose of the packaging into a suitable waste collection container to recycle it.

## Before disposal of the appliance

1. Pull out the main plug from the main socket.
2. Cut off the power cord and discard with the main plug.

## WARNING

Refrigerators contain refrigerant and gases in the insulation. Refrigerant and gases must be disposed of professionally as they may cause eye injuries or ignition.

Ensure that tubing of the refrigerant circuit is not damaged prior to proper disposal.

	Correct Disposal of this product
	<p>This symbol on the product or in its packing indicates that this product may not be treated as household waste. Instead, it should be taken to the appropriate waste collection point for the recycling of electrical and electronic equipment. By ensuring this product is disposed of correctly, you will help prevent potential negative consequences for the environment and human health, which could otherwise be caused by the inappropriate waste handling of this product. For more detailed information about the recycling of this product, please contact your local government, your household waste disposal service, or the shop where you purchased the product.</p>

500 of Cal 40 rniarb6-11Un65Warnings:  
WARNING, This p r f d u c t i o n i n s o n e a r m o m c h e m i c a l s 既 即 n t o t h e S t a t e o f C a l i f o r n i a t o 也 U s e 也 心 r  
WARNING, This p r f d u c t i o n i n s o n e a r m o m c h e m i c a l s 知 即 i n t o t h e S t a t e o f C a l i f o r n i a t o 该 u s e b i r t h 电 仔 J K o r d h e r  
m p d u c t i v e h a m 1