

# DROP

PROTECT WHAT MATTERS



## Installation Manual

Whole House Cartridge Filter

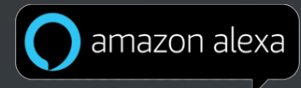

# INTRODUCTION

## Thank You for Purchasing a DROP System!

We know you'll love your improved water quality, leak detection ability and water conservation benefits of your new DROP Water Management System from Chandler Systems. You'll soon wonder how you ever lived without it. Improving your water and protecting your home are just a few of the ways that the DROP Water Management System can improve your water system.

Be sure to check out the [dropconnect.com](http://dropconnect.com) website periodically for more information about additional DROP products as they are released.



833.BUY.DROP  
(833.289.3767)



[dropconnect.com](http://dropconnect.com)

To further help you operate your new DROP system, we have provided you with many other resources for you to learn more. Feel free to call Chandler Systems when you need additional help. We also have many resources located on our website including instructional videos, and images.

DROP Connect is also active on various social media pages! Feel free to follow us for the most up to date information and news!



@dropconnect



### Privacy Statement

For more information about privacy, visit our [privacy policy](#) online.

### DROP Patents

For the most up-to-date list of patents, visit our patents on our website: [dropconnect.com/patents](http://dropconnect.com/patents).

### FCC Compliance Statement:

[https://dropconnect.com/sites/default/files/FCC\\_Compliance\\_Statement.pdf](https://dropconnect.com/sites/default/files/FCC_Compliance_Statement.pdf)

### Industry Canada Compliance Statement:

[https://dropconnect.com/sites/default/files/Industry\\_Canada\\_Compliance\\_Statement.pdf](https://dropconnect.com/sites/default/files/Industry_Canada_Compliance_Statement.pdf)

# TABLE OF CONTENTS



Introduction.....	2
Table of Contents.....	3
<b>How to Use Your System.....</b>	<b>4</b>
Normal Operation.....	4
<b>Installation Instructions.....</b>	<b>5</b>
Contents of Carton.....	5
Cartridge Options.....	6
Precautions.....	7
Cartridge Installation.....	10
Cartridge Replacement.....	14
Controls Installation.....	16
<b>DROP Remote.....</b>	<b>17</b>

## CAUTION:

- Do not subject tank to any vacuum. If there is a possibility that a vacuum could occur, a vacuum breaker must be installed.
- Do not locate unit where the tank or any lines (including drain lines) will be subject to temperatures below freezing.
- If there is not at least 10' of line between the water heater inlet and the outlet of the closest softener/filter, an expansion tank should be installed.
- Do not use Vaseline or any petroleum-based lubricants on O-rings or rubber seals. Only use food-grade silicone lubricant.
- Do not use pipe dope or any sealant other than Teflon tape on threaded connections. Threads on the control valve and on the bypass nut connections do not require any tape because they use an O-ring seal. Tape is only required on the inlet/outlet adapter fittings and on the drain line fitting (if applicable).

# HOW TO USE YOUR SYSTEM

Your DROP Water Management System was selected to address your specific water conditions. Your system uses advanced technology to deliver effective and efficient water treatment to protect your home plumbing system, deliver optimal water quality to you and your family, protect your home from leaks, and save you money, all while providing years of trouble-free operation.

## Normal Operation

Once installed the cartridge filter will do its job filtering your water, while the DROP system monitors your water usage. The lights on the DROP cartridge filter will be a light blue under normal operations. Your DROP system will monitor your water usage and can send you notifications if it identifies anything unusual. Please check out your DROP app on your smart phone or tablet, or see DROP User Documentation for further information.



- **Lights and Flow Indication:** While observing your cartridge filter, you will notice periodic purple flashes on the back lights. These indicate that it is wirelessly communicating to the Hub during that time. Also, when the water meter on your unit senses water flow, the front lights on your device will alternate. The rate of alternation of the lights will give a general idea of the current flow rate. The highest frequency of the lights alternating is determined based on the highest flow seen by your system.
- **Cartridge Filter depleted notification:** As your cartridge filter reaches 5% of the filter life remaining, you will see a notification in the app letting you know that it is almost time to change your filter. If your DROP system is connected to an account on DROP Web Services, then you will also receive notifications via your chosen notification preferences (e-mail, text message or push notification on your phone). Also, the front two lights that indicate flow will turn yellow when your filter reaches 5%. Similarly, when your filter is completely depleted, you will get notifications in the same manner and the front two lights will turn red.
- **Auto Shut Off When Depleted:** For your filter cartridge the water can automatically shut off when the filter is completely depleted. This setting is off by default, but it can be turned on by going to the navigation menu on the left, choosing “Devices” then choosing your cartridge filter. Then navigate to the “Advanced” screen (at the top of the app). In that screen, there will be a setting check box labeled “Shut off water when filter cartridge expires”.
- **Water off and Treatment Off (Bypass):** The lights on your filter can also change color when your device or devices are put into Treatment Off mode or Water Off. If your water is off, the lights will be orange. The water can be turned back on using the app or by shortly pressing the button on the DROP Hub. Please note that for the cartridge filter, water shut off turns off the water on the outlet of the unit. If your filter is set to Treatment Off (bypassed), its lights will be bright yellow. Bypassed means that water will not be treated by that device while it is in bypass mode.



# INSTALLATION INSTRUCTIONS

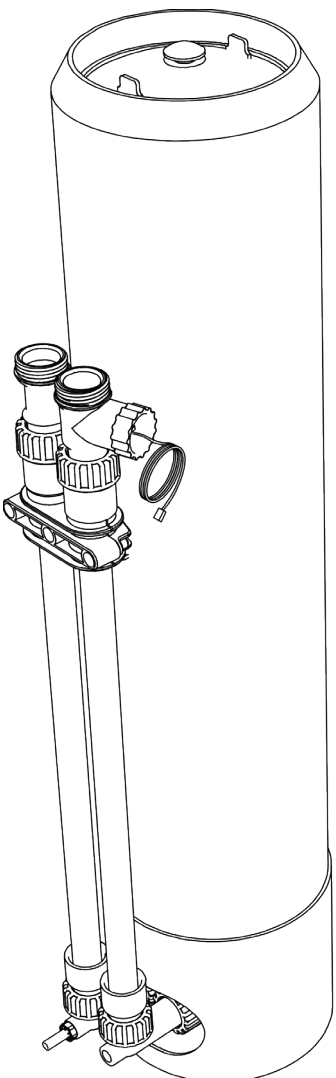
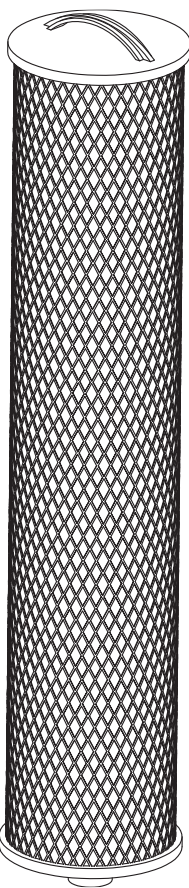
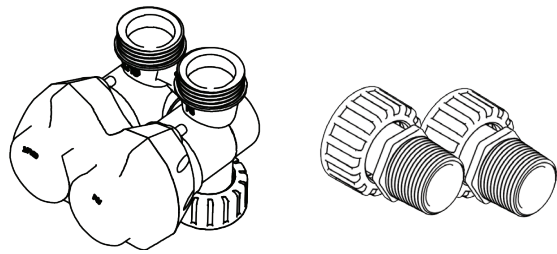
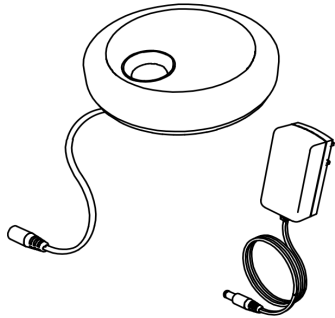
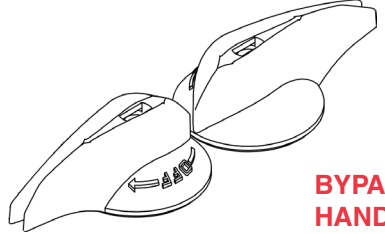
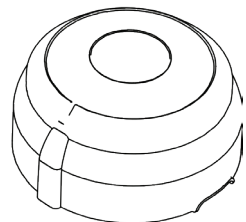

## Contents of Carton

 <p><b>CARTRIDGE TANK</b></p>	 <p><b>CARTRIDGE</b> (Sold Separately)</p>	 <p><b>BYPASS</b>      <b>CONNECTORS</b></p>	
		 <p><b>REMOTE</b> (Optional)</p>	
		 <p><b>BYPASS HANDLES</b></p>	
		 <p><b>HOUSING COVER</b></p>	 <p><b>POWER SUPPLY</b></p>

# INSTALLATION INSTRUCTIONS

## Cartridge Options

### Carbon Block Filters for Taste/ Odor Removal & Sediment

General Specifications	CT-03-CB	CT-20-CB	CT-03-CB-AMINE
Micron Rating	3	20	3
Treatment Description	Chlorine / Sediment	Chlorine / Sediment	Chlorine / Sediment / Chloramine
Max Flow Rate / psi drop	25 gpm / 4 psi	25 gpm / 3 psi	25 gpm / 4 psi
Estimated Gallon Capacity	250,000 gallons of water @ 15 gpm with greater than 90% reduction, estimated capacity using 2ppm of free chlorine	150,000 gallons of water with 90% reduction using 2.0 ppm free chlorine at 7 gpm.	50,000 gallons of water with 85% reduction of chloramine @ 7 gpm.



Carbon Block Filters

### Filters for Sediment Removal

General Specifications	CT-2005 - SWMB	CT-2010	CT-1005
Micron Rating	Outer layer 20 / Inner core 5	Outer layer 20 / Inner core 10	Outer layer 10 / Inner Core 5
Treatment Description	Sediment	Sediment	Sediment
Max Flow Rate / psi drop	25 gpm / 4 psi	25 gpm / 4 psi	25 gpm / 4 psi
Surface area vs typical 4.5" x 20" cartridge	2 times as much	6.5 times as much	6.5 times as much
Filter Type	String Wound w/ Melt Blown Core	Dual Gradient / Double Pleated Polyester	Dual Gradient / Double Pleated Polyester



Poly Wound / Melt Blown



Pleated

# INSTALLATION INSTRUCTIONS



## Precautions

### 1 Read



### 2 Ventilate

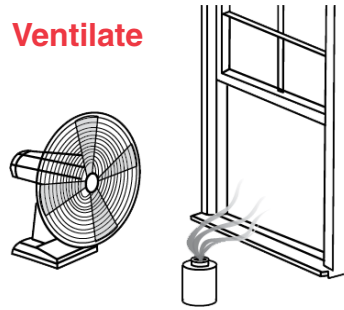

### 3 Use Eye Protection



### 4 Protect nearby materials when soldering.

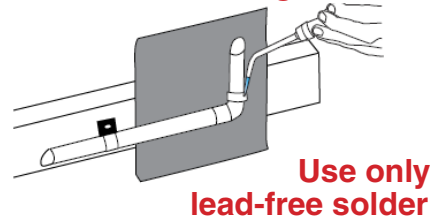

### 5 If existing plumbing is copper, install grounding strap before creating plumbing gaps.

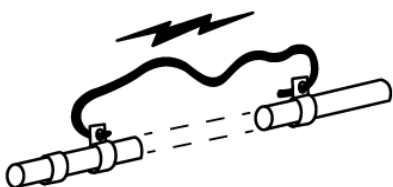

### 6 Don't reach.



# INSTALLATION INSTRUCTIONS

## System Setup

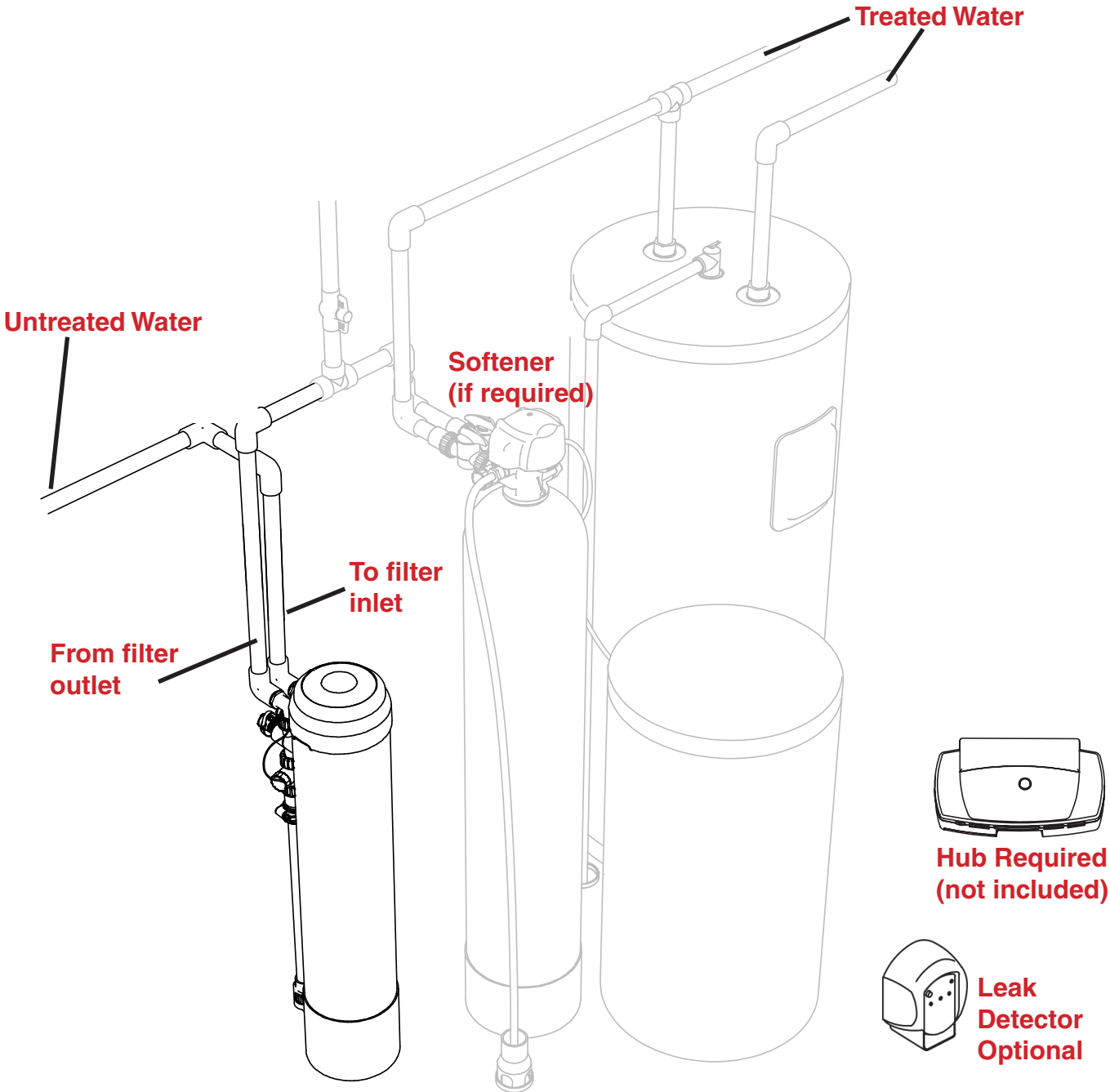

\* Note: Your installation may vary. Follow all local plumbing codes.



# INSTALLATION INSTRUCTIONS



**Installation Requirements**  
**Pressure Range: 10-150 psi**  
**Temperature Range: 40-120 F**  
**Max Service Flow Rate: 25gpm**



*Attach water meter, spacer and bypass assembly. Lubricate connector O-rings with a food grade silicone before installing on bypass. **HAND TIGHTEN ONLY!***



*Take note of the water flow arrows and plumb in your incoming and outgoing water. Use Teflon tape only on connector threads. The use of other sealants can damage the threads.*



*For reference, wiring harness will be installed as shown.*

# INSTALLATION INSTRUCTIONS

## Filter Cartridge Installation



*Remove top cap first.*



*Ensure o-rings are properly lubricated before installation. Insert filter into the filter adapter of the bottom drain assembly.*



*A filter this high is not installed properly.*



*A properly installed filter should sit below the seal area.*



*Ensure the top Pressure Release Cap Lid is installed to fully expose the retaining groove.*



*Install the angled lead tip of the retaining ring into the groove.*

# INSTALLATION INSTRUCTIONS

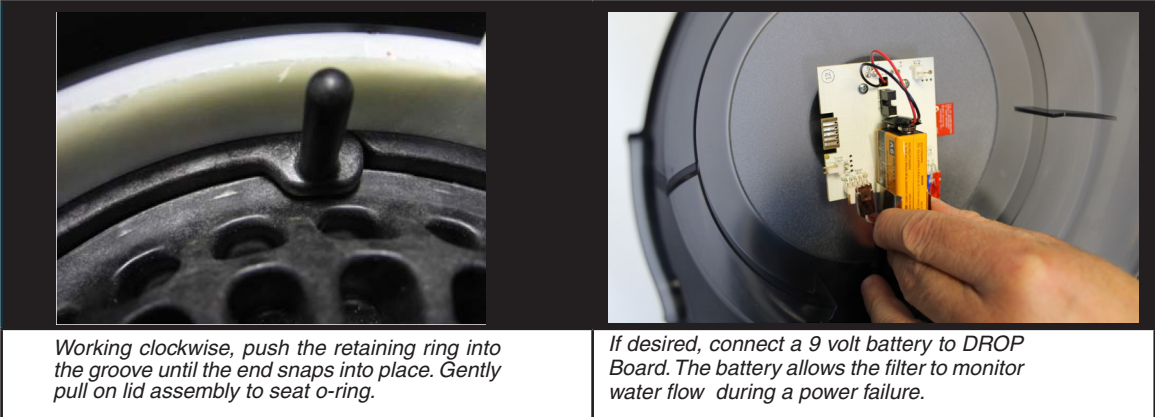

*Working clockwise, push the retaining ring into the groove until the end snaps into place. Gently pull on lid assembly to seat o-ring.*

*If desired, connect a 9 volt battery to DROP Board. The battery allows the filter to monitor water flow during a power failure.*



*Finally place the cap on the tank, ensuring that the wire connections are in the wire trough as shown.*

# INSTALLATION INSTRUCTIONS

## System Setup

This information is available in more detail in the **USER GUIDE**.

**Place the DROP Hub in a central location in your home and plug it in.** At this point, you can download the DROP Connect App on your device. When you open the app, it will walk you through the process of connecting to your Hub and connecting to wifi, if desired.

### Adding devices to the DROP system

Once you have connected to the Hub, you can use the app to connect your devices (softener, leak detectors, salt sensor, etc) to the Hub. First, unplug and remove any batteries from the DROP device you wish to add. Next, navigate to the 'System' (selection on left) > 'Advanced' (selection at top) page in the app and enable the 'Add Device Components' mode. The hub will enter a state where it will accept new connections. Plug in the device(s) that you are adding, or for a leak detector, simply install the batteries. After the device has joined the DROP network you will see it added to the "Manage Device Components" table, you can then disable the 'Add Device Components' mode or simply wait for it to automatically disable.

When a new device is added to the system, you can rename that device by choosing "System" on the left navigation menu and scrolling to the bottom of the System Status page. Devices such as the softener and salt sensor will already be labeled appropriately, but in the case of leak detectors, each individual leak detector will simply be labeled "leak detector." In this case, you can rename each leak detector according to where you put them, such as "water heater" or "kitchen sink."

### System Settings

The first settings that should be changed is the System Water Source. Choose "System" on the left navigation menu and it will bring you to the System Status page, where this setting can be adjusted if needed.

#### *System Water Source*

The system water source setting is used by the DROP system to know how to respond to power outages. It can be set to Private Well or Municipal Supply. If your water supply is not one of these choices, if your water supply is dependent on power to be available (i.e. it is supplied by an electric pump) set it to Private Well, otherwise set it to Municipal Supply.

# INSTALLATION INSTRUCTIONS



## Cartridge Filter Settings

After, you have setup your DROP system and you are connected through the app, use the navigation menu on the left to choose “Devices” and then choose your cartridge filter. On that page in the app you can set the cartridge filter life. The cartridge life is dependent on the water quality and the filter type that is used. Please see the documentation with the cartridge supplied with your filter for information on what to set your cartridge filter life to.

**With the bypass valve in bypass position, turn on the main water supply. This should be done using the app after the hub and valve are set up. Bypass by turning Treatment Off (switch on the left navigation menu). Open a cold water tap nearby, that has the aerator (screen) removed, and let it run a few minutes or until the plumbing is free from foreign material (usually solder) that may have resulted from the installation. Once clean, close the water tap and turn off bypass (Turn Treatment On). As it is filling gently press the red button on the top of the tank to bleed off air in the tank. Once water begins coming out of the red pressure relief button, you can release it. Next, open a cold water tap and run water for several minutes to rinse the filter and release any excess air.**

# CARTRIDGE REPLACEMENT

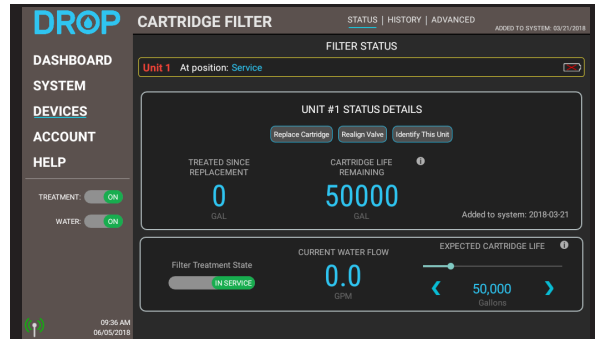

Using the DROP app on your smart phone or tablet, connect to your DROP system. On the navigation menu on the left choose "Devices", and then choose your Cartridge Filter from that list. Assuming you have one filter, you will see a "Replace Cartridge" button on the screen. Press that button and the lights on the cartridge filter should turn yellow. Wait until the lights stop spinning before going to the next step (Should take approximately 30 seconds and you should hear the motors turning).



Remove top cover and relieve pressure in tank by pressing red button.

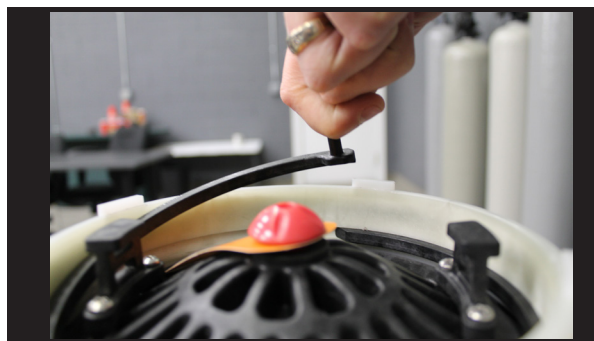

Remove snap ring and tank top from tank.

# CARTRIDGE REPLACEMENT

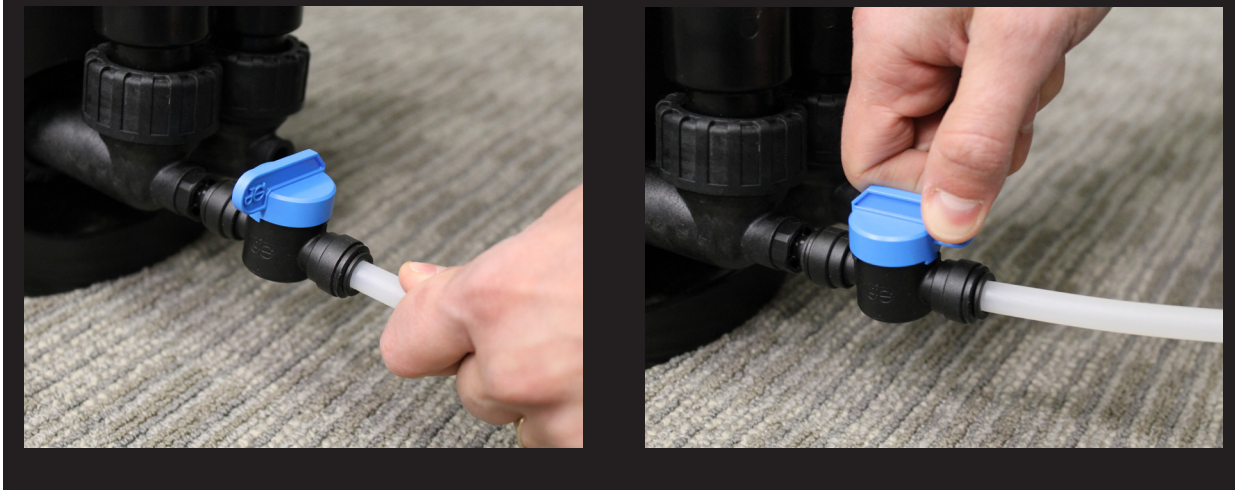

Attach 1/4" X 3/8" poly tubing to John Guest drain valve and run to a suitable drain. Open drain valve & let tank drain.

Pull out old cartridge.

**Note:** You may want to have a bucket available to place the old cartridge in.

Install new cartridge.

Close drain valve.



After filter cartridge is installed, double check that the top snap ring is installed properly and then press the "Replacement Complete" button in the app. The motorized bypass will begin to open and your cartridge filter will begin to fill with water. As it is filling gently press the red button on the top of the tank to bleed off air in the tank as it is filling. Once water begins coming out of the pressure relief button, you can release it.

Open the nearest faucet and run water for several minutes. Check for leaks.



**Note:** After filter installation or replacement the water will look "milky" or "cloudy". This is due to micro bubbles from the filter being released into the water. They are just tiny air bubbles and are harmless. The bubbles will go away after the first few hours after installation.

# CONTROLS INSTALLATION

## DROP Controls installation

**In the event of an emergency or motor malfunction, we have provided bypass handles.**

Carefully remove the motorized bypass drive from the bypass that is on the cartridge filter. When it is removed it should be oriented so that the bypass is parallel or in-line with the pipes. The bypass can be slid off by gently prying up underneath until they start to slide off more easily. When done using blue bypass handles, store handles somewhere nearby in case they are needed for future use.

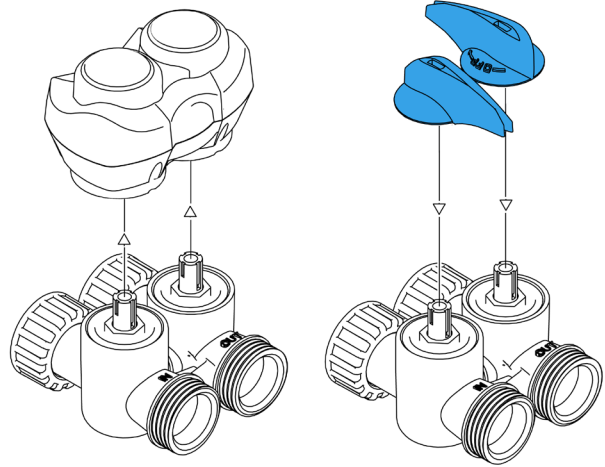

**Bypass handles can be stored on top of the tank, under the DROP lid, for safekeeping.**

Slide the over the valve stems where the motorized bypass drive was just removed.

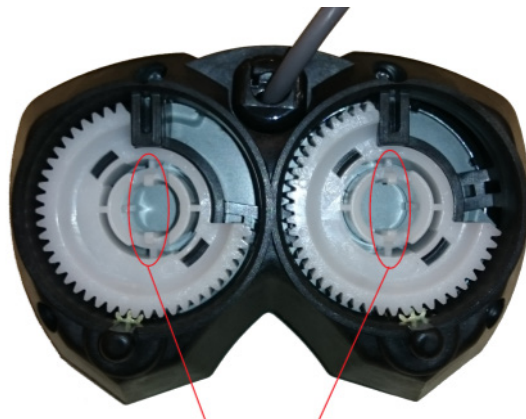

When reinstalling the motorized bypass, make sure that that the orientation of the clips on the handles match the grooves on the valve stems where the motorized bypass drive was removed.

**If at any time you feel your system is not operating properly, bypass the system and call your authorized DROP Water Management System representative.**



# THE DROP REMOTE



**The DROP Remote is sold as an optional accessory.**

In addition to acting as a DROP Link mesh network extender, the DROP Remote has additional features:

At a glance the remote can provide the status of your water system through color codes.

## Color codes for normal operation

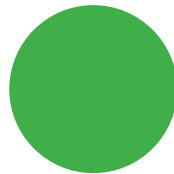

*Water is in Service*

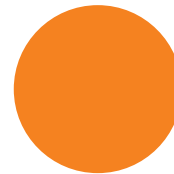

*Water is Shutoff*

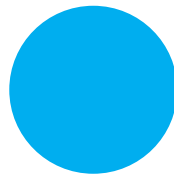

*Slow blinking indicates you have a notification in your DROP App that has not been seen*

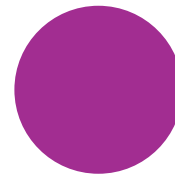

*Flashes indicate that the DROP Remote is communicating with other devices*

To turn off water in your home, place your finger on the water DROplet button for about 2 seconds. Once the lights turn orange, remove your finger.

If your system is in the Shutoff mode and you would like to turn your water back on, place your finger on the DROplet button for about 2 seconds. When it turns green, remove your finger and, your water will turn back on.

More details about the DROP Remote can be found in the DROP User Guide.

## WATER MANAGEMENT SYSTEMS

This warranty cannot be transferred - it is extended only to the original purchaser or first user of the product. By accepting and keeping this product, you agree to all of the warranty terms and limitations of liability described below.

**Important Warning:** Read carefully the DROP Water Management Systems Equipment Installation, Operating and Maintenance Instructions Manual to avoid serious personal injury and property HAZARDS and to ensure safe and proper care of this product.

\*FOR AS LONG AS YOU OWN AND LIVE IN YOUR SINGLE FAMILY HOME, this warranty covers your water treatment equipment, if you are the first user of this DROP Water Treatment Systems equipment and purchased it for single family home use - subject to all of the conditions, limitations and exclusions listed below. Purchasers who buy the DROP equipment for other purposes, and other component parts are subject to more limited warranties and you should read all of the terms included in this form to make sure you understand your warranty.

What is covered by this warranty?

Chandler Systems, Inc. warrants that at the time of manufacture, the DROP equipment shall be free from defects in material and workmanship as follows:

Product	Warranty
Residential Mineral Tank	10 Years
DROP Control Valves	5 Years
DROP Pump Controllers	5 Years
DROP Home Protection Valve	5 Years
Brine Tank	5 Years
DROP Hub and Remote	1 Year
DROP Wireless Low Salt Alarm	1 Year
Other Accessories and Parts	1 Year
Brine Tank Components	1 Year

\* This warranty does not include media and/or cartridge filter elements.

### Additional Terms & Conditions

What Chandler Systems Inc will do if you have a covered warranty claim; Chandler Systems Inc will at its discretion either make repairs to correct any defect in material or workmanship or supply and ship either new or used replacement parts or products. Chandler Systems, Inc. will not accept any claims for labor or other costs.

### Additional Exclusions and Limitations

This warranty is non-transferable and does not cover any failure or problem unless it was caused solely by a defect in material or workmanship. In addition, this warranty shall not apply:

- If the equipment is not correctly installed, operated, repaired and maintained as described in the Installation, Operating & Maintenance Instructions Manual provided with the product.
- Defects caused as a direct result of the incoming water quality
- If the DROP equipment is not sized appropriately for the intended job.

- To any failure or malfunction resulting from abuse (including freezing), improper or negligent; handling, shipping (by anyone other than DROP)
- If the unit has not always been operated within the factory recommended temperature limits, and at a water pressure not exceeding 125 psi, during storage, use, operation, accident; or alteration, lightning, flooding or other environmental conditions.
- To any failure or malfunction resulting from failure to operate the system with potable water, free to circulate at all times; and free of damaging water sediment or scale.
- This warranty does not cover labor costs, shipping charges, service charges, delivery expenses, property damage, administrative fees or any costs incurred by the purchaser in removing or reinstalling the water management equipment.
- The warranty does not cover any claims submitted more than 30 days after expiration of the applicable warranty, and does not apply unless prompt notice of any claim is given to an authorized DROP Dealer or to DROP or a designated contractor is provided access to the installation and to the water treatment equipment.

THESE WARRANTIES ARE GIVEN IN LIEU OF ALL OTHER EXPRESS WARRANTIES. NO DROP REPRESENTATIVE OR ANY OTHER PARTY IS AUTHORIZED TO MAKE ANY WARRANTY OTHER THAN THOSE EXPRESSLY CONTAINED IN THIS WARRANTY AGREEMENT.

### Additional Warranty Limitations

ANY IMPLIED WARRANTIES THE PURCHASER MAY HAVE, INCLUDING THE IMPLIED WARRANTIES OF MERCHANTABILITY AND FITNESS FOR A PARTICULAR PURPOSE, SHALL NOT EXTEND BEYOND THE APPLICABLE TIME PERIODS SPECIFIED ABOVE. Some states do not allow limitations on how long an implied warranty lasts, so the above limitations may not apply to you.

### Limitations of Remedies

The remedies contained in this warranty are the purchaser's exclusive remedies. In no circumstances will Chandler Systems, Inc. or the seller of the product be liable for more than, and purchaser-user's remedies shall not exceed, the price paid for the product. In no case shall Chandler Systems, Inc. or seller be liable for any special, incidental, contingent or consequential damages. Special, incidental, contingent and consequential damages for which Chandler Systems, Inc. is not liable include, but are not limited to, inconvenience, loss or damage to property, consequential mold damage, loss of profits, loss of savings or revenue, loss of use of the products or any associated equipment, facilities, buildings or services, downtime, and the claims of third parties including customers. Some states do not allow the exclusion or the limitation of incidental or consequential damages, so the above limitations or exclusion may not apply to you.

### What to do if you have a problem covered by this warranty

Any warranty coverage must be authorized by Chandler Systems, Inc.. Contact the person from whom you purchased the product, who must receive authorization from a DROP Dealer.

If your product is new and not used and you wish to return it, contact your DROP Dealer.



**Note:** This equipment has been tested and found to comply with the limits for a Class B digital device, pursuant to part 15 of the FCC Rules. These limits are designed to provide reasonable protection against harmful interference in a residential installation. This equipment generates, uses and can radiate radio frequency energy and, if not installed and used in accordance with the instructions, may cause harmful interference to radio communications. However, there is no guarantee that interference will not occur in a particular installation. If this equipment does cause harmful interference to radio or television reception, which can be determined by turning the equipment off and on, the user is encouraged to try to correct the interference by one or more of the following measures:

- Reorient or relocate the receiving antenna.
- Increase the separation between the equipment and receiver.
- Connect the equipment into an outlet on a circuit different from that to which the receiver is connected.
- Consult the dealer or an experienced radio/TV technician for help.

This product may be covered by one or more patents. (<https://dropconnect.com/patents>)

**Chandler Systems Inc.**  
710 Orange St.  
Ashland, OH 44805

P. 1 833 BUY-DROP  
[www.dropconnect.com](http://www.dropconnect.com)

