

CP 150 12-lead resting electrocardiograph



Directions for use

Software version 2.10.XX

WelchAllyn[®]

Advancing Frontline Care[™]

© 2016 Welch Allyn, Inc. All rights are reserved. To support the intended use of the product described in this publication, the purchaser of the product is permitted to copy this publication, for internal distribution only, from the media provided by Welch Allyn. No other use, reproduction, or distribution of this publication, or any part of it, is permitted without written permission from Welch Allyn. Welch Allyn assumes no responsibility for any injury, or for any illegal or improper use of the product, that may result from failure to use this product in accordance with the instructions, cautions, warnings, or indications for use published in this manual.

Welch Allyn is a registered trademark of Welch Allyn, Inc. CP 150, and CardioPerfect are trademarks of Welch Allyn, Inc.

Patent information

For patent information, please visit www.welchallyn.com/patents.

Software in this product is copyright Welch Allyn or its vendors. All rights are reserved. The software is protected by United States of America copyright laws and international treaty provisions applicable worldwide. Under such laws, the licensee is entitled to use the copy of the software incorporated within this instrument as intended in the operation of the product in which it is embedded. The software may not be copied, decompiled, reverse-engineered, disassembled or otherwise reduced to human-perceivable form. This is not a sale of the software or any copy of the software; all right, title and ownership of the software remains with Welch Allyn or its vendors.

For information about any Welch Allyn product, contact Welch Allyn Technical Support: <http://www.welchallyn.com/>

106580 (CD)
DIR 80020057 Ver. D

This manual applies to the REF 901049 ELECTROCARDIOGRAPH



Welch Allyn, Inc.
4341 State Street Road
Skaneateles Falls, NY 13153 U.S.A
www.welchallyn.com

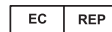

Regulatory Affairs Representative
Welch Allyn Limited
Navan Business Park
Dublin Road
Navan, County Meath
Republic of Ireland

Revision date: 2016-05



WelchAllyn[®]
Advancing Frontline Care[™]

Contents

Introduction	1
About this document	1
Intended use	1
Indications for use	1
Contraindications	1
Description	1
Features	2
Configuration options for CP150 electrocardiograph	3
Controls, indicators, and connectors	5
Symbols	7
General warnings	10
General cautions	12
Setup	15
Connecting the patient cable	15
Loading the thermal paper	15
Powering the electrocardiograph	16
Secure the AC power cord around the cord wrap of the mobile stand	17
Verifying proper operation	17
ECG home screen	19
ECG home screen	19
ECG tests	23
Attach the leads to the patient	23
View electrode placement	24
Electrode locations	25
Use the New Patient tab to perform an Auto ECG test	26
Saved tests	31
Search for saved tests	31
Manage the saved tests	31
Manage worklist	33
Download the worklist when connected to the Worklist server	33
Settings	35
View or change the ECG settings	35
View or change the device information	37
Advanced settings	39
Access Advanced settings	39

Regional	39
Device	40
Data management	41
Ownership	41
Start Demo	42
Network	42
Service	49
Maintenance	53
Cleaning the equipment	53
Inspecting the equipment	54
Testing the electrocardiograph	54
Replacing the battery	55
Replacing the AC fuses	55
Storing the equipment	56
Disposing of electronic equipment	56
Troubleshooting	57
Lead-quality problems	57
System problems	60
Service policy	63
Limited warranty	65
General compliance and standards	67
Device radio	67
General radio compliance	69
Federal Communications Commission (FCC)	69
Industry Canada (IC) emissions	70
European Union	71
EMC guidance and manufacturer's declarations	72
Specifications	77
Appendix	81
Approved accessories	81

Introduction

About this document

This document is written for clinical professionals with a working knowledge of medical procedures and terminology required for monitoring cardiac patients.

Before using the electrocardiograph for clinical applications — or before setting up, configuring, troubleshooting, or servicing the electrocardiograph — you must read and understand this document and all other information that accompanies the electrocardiograph and related options or accessories.

Intended use

The Welch Allyn CP150™ is an electrocardiograph used to process the electrical signal transmitted through two or more electrocardiograph electrodes and to produce a visual display of the electrical signal produced by the heart.

The CP150™ Electrocardiograph is specifically intended for acquiring and printing ECG signals from adults and pediatric patients. It will be used in clinical settings by trained healthcare providers. The optional interpretation algorithm analyzes these ECG signals to generate measurements and interpretive statements. The interpretive results are intended only as guidance for qualified physicians and must not be relied upon as diagnoses.

Indications for use

The electrocardiograph is one of the tools that clinicians use to evaluate, diagnose, and measure patient cardiac function.

The 12-lead optional interpretation algorithm provides a computer-generated analysis of potential patient cardiac abnormalities, which must be confirmed by a physician with other relevant clinical information.

Contraindications

The electrocardiograph has no known contraindications.

Description

- The electrocardiograph is not suitable for direct cardiac application.
- The electrocardiograph allows users to perform 12-lead ECG measurements and analysis.

- The electrocardiograph supports STAT, Auto, and Rhythm test types.
- The electrocardiograph provides the ability to print test records on an internal printer.
- The electrocardiograph provides the ability to send test records and analysis directly to an electronic medical records (EMR) system.
- The electrocardiograph allows storage of test records in device memory, external storage media, and external software applications.
- The electrocardiograph allows users to enter patient demographic data into the electrocardiograph memory to be recalled for a test later that day.

Features

Pacemaker detection

The software detects the possible presence of a pacemaker. If you confirm that the patient has a pacemaker, the ECG report includes no interpretation, and it indicates that a pacemaker was detected.

WiFi connectivity (optional)

The optional WiFi capability allows for wireless connectivity and enhanced workflow alternatives. Reduces the reliance on a wired connection.

DICOM format support (optional)

The optional DICOM capability enables direct communication with PACS and EMR systems. Acquire worklist orders and share 12-lead ECG waveforms with the recipient system to enhance workflow efficiency.

Automatic ECG interpretation (optional)

The optional MEANS interpretation algorithm, developed by the University of Rotterdam in the Netherlands, provides automatic analysis of ECG tests. For more information, see the MEANS Physicians' Manual or the PEDMEANS Physicians' Manual on the CD that came with your electrocardiograph. The MEANS algorithm is used for adult patients 18 years and older. The PEDMEANS algorithm is used for pediatric patients from 1 day through 17 years old.



CAUTION Check for the presence of a pacemaker before using ECG with interpretation.



WARNING A computer generated interpretation cannot replace sound medical reasoning by a trained professional. Therefore, a physician should always review the interpretation.

Spirometry (optional)

The CP 150 spirometry option allows the user to acquire, view, store, and print, measures and waveforms of pulmonary function including, but not limited to, maximal volume and flow of air that can be moved in and out of a patient's lungs. These

measures are used in the diagnosis and monitoring of lung diseases and interventions for the treatment of certain lung diseases.

Configuration options for CP150 electrocardiograph

Model	Accessories	Language	Power cord
CP150	1 - AHA, disposable	EN - English	2 - Europe
A - Interpretation	2 - IEC, disposable	FR - French	3 - Israel
W - WiFi	3 - AHA, reusable	DE - German	4 - UK
D - DICOM	4 - IEC, reusable	ES - Spanish	5 - Switzerland
		NL - Dutch	66 - Australia
		BP - Brazilian Portuguese	7 - S. Africa
		PT - Portuguese	B - North America
		ZH - Simplified Chinese	C - China
		RU - Russian	G - Argentina
		NO - Norwegian	N - India/UAE
		SV - Swedish	Z - Brazil
		DA - Danish	
		FI - Finnish	
		IT - Italian	
		TR - Turkish	
		KN - Korean	
		TC - Traditional Chinese	

Examples: CP150-1ENB, CP150A-1ENB, CP150WD-1ENB, CP150W-1ENB, CP150A-4DE5

Configurations for CP150 electrocardiograph with spirometry option

Model	Accessories	Language	Power cord
CP150	1 - AHA, disposable	EN - English	B - North America
A - Interpretation	2 - IEC, disposable		

Model	Accessories	Language	Power cord
S - Spirometry	3 - AHA, reusable		
W - WiFi	4 - IEC, reusable		

Note The spirometry option is only available in English.

Examples: CP150S-1ENB and CP150AS-1ENB

Controls, indicators, and connectors

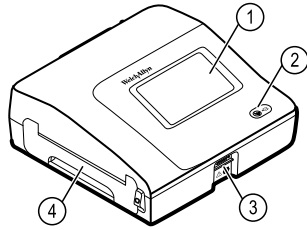

No.	Feature	Description
1	LCD screen	800 x 480 pixels color touchscreen provides a graphical user interface.
2	Power switch and LED	Power-on/Standby switch. The LED indicates the charging status when connected to AC power: <ul style="list-style-type: none"> • Green: The battery is charged. • Amber: The battery is charging.
3	Patient cable connector	Provides connection for patient cable.
4	Printer	Printer provides a printout of patient Auto ECG, Stat ECG, or Rhythm ECG.

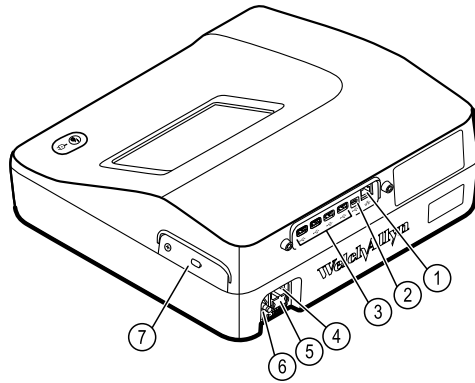





Back view















No.	Feature	Description
1	Ethernet connector	Provides a hardwired connection to the computer network. The LEDs indicate active network status when the ethernet cable is connected to a network.
2	Clients USB	USB, type "mini B." Provides connection to an enabled host.
3	Host USB	USB, type "A." Provides four host USB connections for optional accessories.
4	Power connection	Provides an external AC power connection.
5	AC fuse	Provides access to AC fuse.
6	Ground lug (equipotential terminal)	Provided for electrical safety testing and as a means for connection of a potential equalization conductor.
7	Battery compartment (behind cover)	Houses the Li-ion battery.

Symbols



Documentation symbols

	<p>WARNING The warning statements in this manual identify conditions or practices that could lead to illness, injury, or death.</p>		<p>Caution The caution statements in this manual identify conditions or practices that could result in damage to the equipment or other property, or loss of data. This definition applies to both yellow and black and white symbols.</p>
	<p>Consult directions for use (DFU). A copy of the DFU is available on this website. A printed copy of the DFU can be ordered from Welch Allyn for delivery within 7 calendar days.</p>	 	<p>Meets essential requirements of the European Medical Device Directive 93/42/EC</p>





Power symbols

	<p>Power on/standby</p>		<p>Battery</p>
	<p>Alternating Current power present, battery fully charged</p>		<p>Battery absent or faulty</p>
	<p>Alternating Current power present, battery is charging</p>		<p>Battery charge level</p>
	<p>Alternating current (AC)</p>		<p>Battery Charging - AC powered</p>
	<p>Dangerous voltage</p>		<p>Power plug</p>
	<p>Fuse</p>	 <p>Li-ion</p>	<p>Rechargeable battery</p>
	<p>Protective Earth (PE)</p>		<p>Rated power input, AC</p>
	<p>Equipotential Ground</p>		









Connectivity symbols





	USB		Ethernet
---	-----	---	----------

Wireless radio symbols





	<p>Wireless signal strength</p> <ul style="list-style-type: none"> • Best (4 bars) • Good (3 bars) • Fair (2 bars) • Weak (1 bar) • No connection (no bars) 		Non-ionizing electromagnetic radiation
FCC ID	The identification number assigned by the Federal Communications Commission SQG-WB45NBT	IC ID	Industry Canada identification number. The equivalent governing body to the FCC in the United States 3147A-WB45NBT
	Australian Communications and Media Authority (ACMA) Radio Compliance Mark (RCM)		This device complies with Article 58-2 Radio Waves Act of Korea Communications Commission.
	MODELO: WB45NBT 1130-15-8547		Brazil: ANATEL Model No. 1130-15-8547 07898949039068

Shipping, storing, and environment symbols

	This way up		Keep Dry
	Fragile		Humidity limitation
	Temperature limit		Atmospheric pressure limitation
	Separate collection of batteries. Do not dispose as unsorted municipal waste.		Recyclable

	Separate collection of Electrical and Electronic Equipment. Do not dispose as unsorted municipal waste.		China RoHS
Li-ion	Lithium ion battery		Keep away from sunlight
	Use by Date	IP20	Protected against the ingress of solid foreign objects ≥ 12.5 mm diameter, not protected against the ingress of water.

Miscellaneous symbols

	Manufacturer		Defibrillation-proof Type CF applied part
REF	Product Identifier	SN	Serial Number
#	Reorder Number	LOT	Lot Code
R_x ONLY	Prescription only or "For Use by or on the order of a licensed medical professional"		Do not re-use, Single use device
EC REP	Authorized Representative in the European Community	GTIN	Global Trade Item Number
	Call for maintenance		Clock; time switch; timer

General warnings

Warnings indicate conditions or practices that could lead to illness, injury, or death.

Warnings related to the environment



WARNING The power cord is considered the disconnect device for isolating this equipment from supply mains. Do not position the equipment so that it is difficult to reach or disconnect.



WARNING To avoid a possible explosion, do not use the electrocardiograph in the presence of flammable anesthetics: mixtures containing air, oxygen, or nitrous oxide.



WARNING When transporting the electrocardiograph on a cart, tuck the patient cable away to keep them clear of the wheels and to minimize trip hazards.

Warnings related to accessories and other equipment



WARNING To avoid the risk of electric shock, this equipment must only be connected to a supply mains with protective earth.



WARNING For operator and patient safety, peripheral equipment and accessories that can come in direct patient contact must be in compliance with all appropriate safety, EMC, and regulatory requirements.



WARNING All signal input and output (I/O) connectors are intended for connection of only devices complying with IEC 60601-1, or other IEC standards (for example, IEC 60950), as appropriate to the device. Connecting additional devices to the electrocardiograph might increase chassis or patient leakage currents.



WARNING The electrocardiograph has not been designed for use with high-frequency (HF) surgical equipment and does not protect against hazards to the patient.



WARNING Defective batteries can damage the electrocardiograph. Visually inspect the battery at least monthly, if the battery shows any signs of damage or cracking, it must be replaced immediately and only with a battery approved by Welch Allyn.



WARNING Improper disposal of batteries may create an explosion or contamination hazard. Never dispose of batteries in refuse containers. Always recycle batteries according to local regulations.



WARNING All signal input and output (SIP/SOP) connectors should not be contacted by patient directly and indirectly through the user during operation.



WARNING Use only parts and accessories, including thermal paper, that were supplied with the device and available through Welch Allyn. The use of accessories other than those specified may result in degraded performance or unsafe use of this device.

Warnings related to using the electrocardiograph



WARNING No modification of this equipment is allowed.



WARNING This device captures and presents data reflecting a patient's physiological condition. When reviewed by a trained physician or clinician, this data can be useful in determining a diagnosis. However, the data should not be used as a sole means for determining a patient's diagnosis or prescribing treatment.



WARNING To provide CF protection use only accessories approved by Welch Allyn. Visit www.welchallyn.com. The use of any other accessories can result in inaccurate patient data, can damage the equipment, and can void your product warranty.



WARNING To avoid serious injury or death, take these precautions during patient defibrillation:

- Avoid contact with the electrocardiograph, patient cable, and patient.
- Verify that the patient leads are properly connected.
- Place defibrillator paddles properly in relation to electrodes.
- After defibrillation, pull each patient lead out of the patient cable and inspect the tips for charring (black carbon marks). If there is any charring, the patient cable and individual leads must be replaced. If there is no charring, fully reinsert the leads into the patient cable. (Charring can occur only if a lead is not fully inserted into the patient cable before defibrillation.)



WARNING To prevent the spread of infection, take these precautions:

- Dispose of single-use components (for example, electrodes) after using them once.
- Regularly clean all components that come in contact with patients.
- Avoid ECG testing for patients with open, infectious sores.



WARNING Avoid positioning any leads or cables so that they could easily trip someone or become wrapped around a patient's neck.



WARNING To ensure safe use of the device, follow the documented maintenance procedures.



WARNING Only qualified service personnel should attempt to repair the electrocardiograph. In case of a malfunction, call Technical Support.



WARNING Do not perform ST segment analysis on the ECG screen display, since these ECG representations are scaled. Make manual measurements of ECG intervals and magnitudes on printed ECG reports only.



WARNING To maintain diagnostic accuracy and to comply with IEC 60601-02-51 and IEC 60601-02-25, do not scale (re size) when sending a saved ECG to an external printer.



WARNING To avoid injury, do not touch the print head immediately after printing. It might be hot.



WARNING To avoid the risk of associating reports with the wrong patients, make sure that each test identifies the patient. Do not save a test to the patient record without patient identification associated with the report.

General cautions

Cautions indicate conditions or practices that could damage the equipment or other property.



CAUTION Federal US law restricts sale of the device identified in this manual to, or on the order of, a licensed physician.



CAUTION When removing the electrocardiograph from storage, allow it to thermally stabilize to surrounding environmental conditions before using it.



CAUTION To prevent possible damage, do not use sharp or hard objects to press the touch screen or the buttons. Only use fingertips.



CAUTION Do not expose the patient cable to strong ultraviolet radiation.



CAUTION Do not pull or stretch the patient cable. Doing so could result in mechanical or electrical failures. Form the patient cable into a loose loop before storing.



CAUTION Avoid positioning the patient cable where it might get pinched, stretched, or stepped on. Otherwise, measurements might no longer be accurate, and repair might be necessary.



CAUTION Using the equipotential terminal for anything but grounding purposes may contribute to damage of the device.



CAUTION Portable and mobile RF communications equipment can affect the performance of the electrocardiograph.



CAUTION The electrocardiograph meets the Class A requirements of IEC 60601-1-2 regarding incidental emission of radio frequency interference. As such it is suitable for use in commercial grade electrical environments. If the electrocardiograph is used in residential grade electrical environments and you experience incidental interference with other equipment that uses radio frequency signals to operate, minimize the interference.



CAUTION Other medical equipment—including but not limited to defibrillators, ultrasound machines, pacemakers, and other stimulators—may be used simultaneously with the electrocardiograph. However, such devices may disturb the electrocardiograph signal.



CAUTION The power cord must be disconnected from AC power before cleaning, maintaining, transporting, or servicing.



CAUTION The requirements of AAMI EC11, Section 3.2.7.2, Frequency and Impulse Response, for an impulse triangle waveform may be impacted by up to 5 milliseconds of small amplitude dampened ringing immediately after the impulse when the muscle filter (35 Hz) is turned on or a small amplitude offset when the baseline filter (0.5 Hz) is turned on. These filters, in any combination turned on or off, meet the AAMI requirements. Measurements performed by the optional interpretation algorithm are unaffected by any filter selections.

Note

The entire patient cable, up to and including the electrodes are considered to be an Applied Part.

Setup

Connecting the patient cable

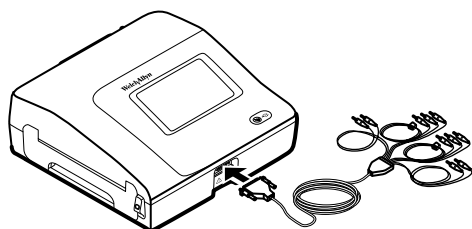

WARNING Do not allow the conductive parts of the patient cable, electrodes, or associated connections of defibrillation-proof applied parts, including the neutral conductor of the patient cable and electrodes, to come into contact with other conductive parts, including earth ground. Otherwise, an electrical short might result, risking electric shock to patients and damage to the device.



WARNING To avoid injury to the patient or damage to the device, never plug patient leads into any other device or wall outlet.



WARNING To provide CF protection use only accessories approved by Welch Allyn. Visit www.welchallyn.com. The use of any other accessories can result in inaccurate patient data, can damage the equipment, and can void your product warranty.



CAUTION Always connect the patient cable and the leads properly during defibrillation. Otherwise, the connected leads could be damaged.

Loading the thermal paper

The electrocardiograph prints on z-fold thermal paper.

- Store the paper in a cool, dry, dark place.
- Do not expose it to bright light or UV sources.
- Do not expose it to solvents, adhesives, or cleaning fluids.
- Do not store it with vinyls, plastics, or shrink wraps.

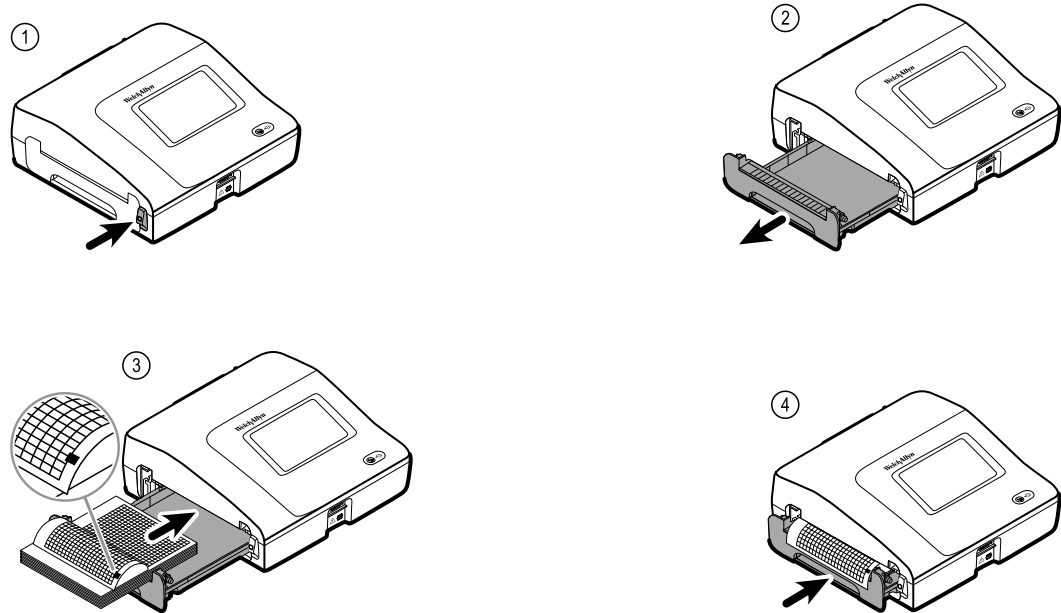

Powering the electrocardiograph

The electrocardiograph runs on AC or battery power. Plug the electrocardiograph into AC power as often as possible so that the built-in charger can keep the battery charged. Regardless of the battery condition, you can use the electrocardiograph whenever it is plugged in.



WARNING When you use AC power, always plug the electrocardiograph into a hospital-grade outlet to avoid the risk of shock.



WARNING If the integrity of the building's safety ground is in doubt, operate this device on battery power to avoid the risk of shock.

To turn on or turn off



Press

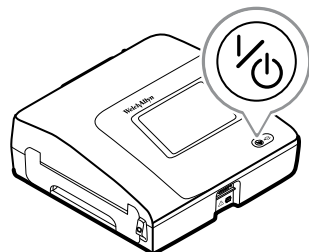

Secure the AC power cord around the cord wrap of the mobile stand

Note To avoid stress on the AC power connection, loop the power cord around the mobile stand cord wrap.



WARNING When you use AC power, always plug the electrocardiograph into a hospital-grade outlet to avoid the risk of shock.



WARNING When transporting the electrocardiograph on a cart, tuck the patient cable away to keep them clear of the wheels and to minimize trip hazards.



WARNING Avoid positioning any leads or cables so that they could easily trip someone or become wrapped around a patient's neck.

Welch Allyn recommends looping the power cord around the mobile stand cord wrap as shown.

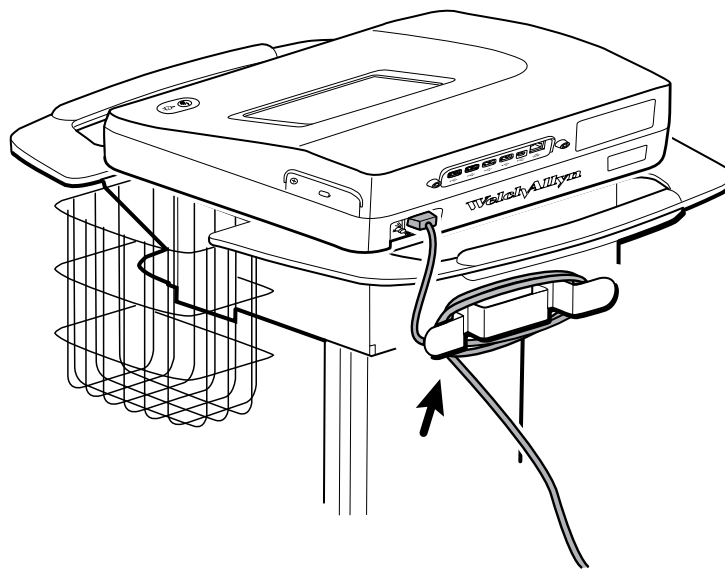

Verifying proper operation

To ensure the accuracy of test data, you should verify proper operation of the electrocardiograph before it is used for the first time with patients. You should reverify proper operation once a year.

To verify proper operation

1. Use an ECG simulator to acquire and print a standard 12-lead ECG of known amplitude and rate.
2. Look for the following indications of proper operation:
 - Printing should be dark and even across the page.
 - There should be no evidence of print-head dot failure (no printing breaks forming horizontal streaks).

- Thermal paper should move smoothly and consistently during printing.
 - The waveforms should have no distortion or excessive noise.
 - The amplitude and rate of the waveforms should match the input value from the ECG simulator.
 - Z-fold thermal paper should stop with perforations near the tear bar, indicating proper cue-sensor operation.
3. If you see any indications of improper operation, contact Welch Allyn Technical Support.

ECG home screen

ECG home screen

The ECG home screen includes the following areas:

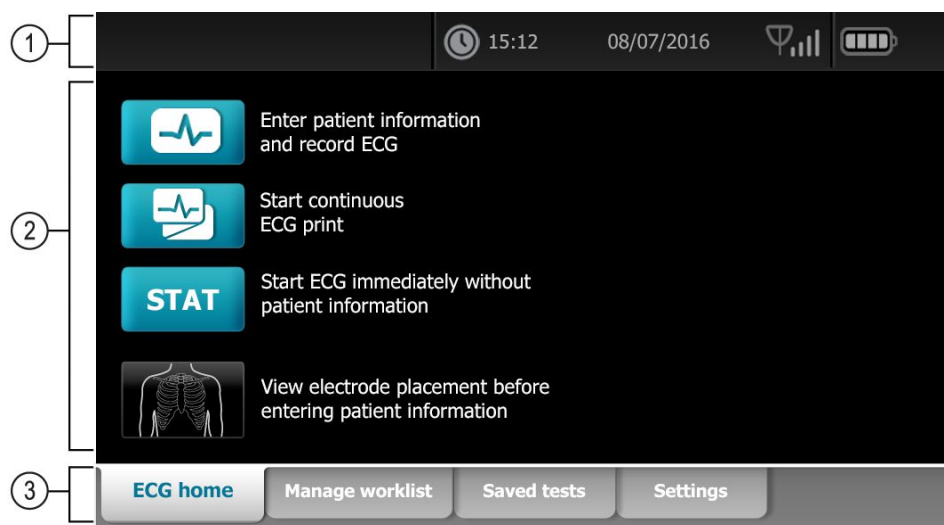

Item	Area
1	Device status
2	Content
3	Navigation

Device status area

The Device status area, located at the top of the ECG home screen, displays:

- Patient Icon and Patient name. Once the patient context is established, the format of the Patient name appears as last name, first name.
- Time and date
- Connectivity status. The icons indicate which connection type, if any, is currently active.

- Battery status
- Error or information messages. These items are displayed until the condition has been resolved.

Content area

The Content area includes 3 test selection buttons and a preview selection button:

- **Auto ECG**
- **Rhythm ECG**
- **Stat ECG**
- **Electrode Placement (ECG preview)**

The content area also provides shortcuts to several controls.

About the test types

Auto ECG

A report typically showing a 10-second acquisition of 12 leads of ECG information combined with patient data, measurements, and optional interpretation.



Rhythm ECG

A continuous, real-time printout of rhythm strips with a user-defined lead configuration. Rhythm ECGs are printouts only. They cannot be saved.



Stat ECG

An auto ECG that starts without waiting for you to enter patient data. Patient data does not appear.



WARNING To avoid the risk of associating reports with the wrong patients, make sure that each test identifies the patient. Do not save a test to the patient record without patient identification associated with the report.

Navigation area

The Navigation area includes the following tabs:

- **ECG home:** Displays ECG test types and provides shortcuts to several controls.
- **Manage worklist :** Includes patient data and orders downloaded when connected to a hospital information system (Worklist server).
- **Saved tests:** Accesses the patient ECG tests.
- **Settings:** Accesses device configuration settings.

To navigate to a tab, touch the tab in the Navigation area with the corresponding name. The active tab is highlighted.

Example ECG report

ID:	STAT_e131fddf	Gender:	Unknown	Page: 1	warning: age not available, assumed 35 years
Name:		Race:		03/10/2012 08:09:54AM	warning: sex not available, assumed male
Age:				PR: 92/168 ms	sinus rhythm
Weight:				QRS: 92 ms	probable septal infarct
Height:				QT/QTc: 396/396 ms	Abnormal ECG
				P/QRS/T axis: 28/53/40 deg	Unconfirmed Report
				Heart rate: 60 bpm	

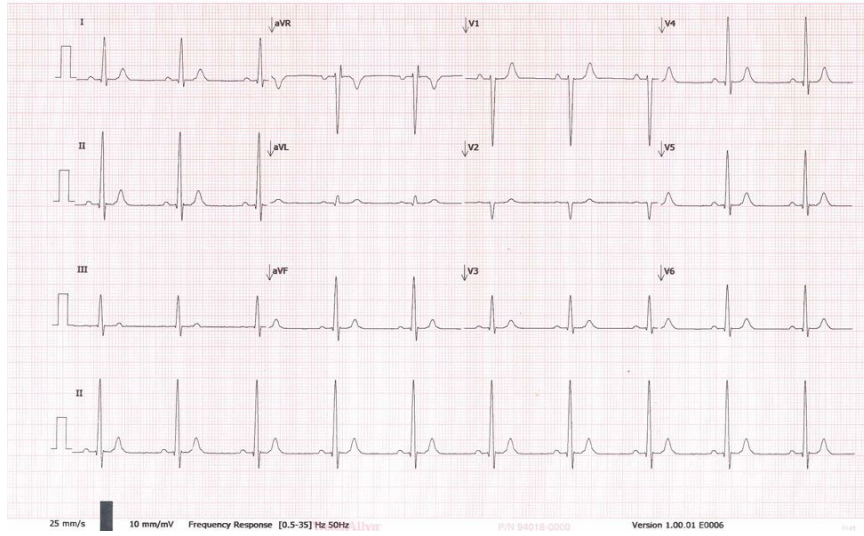

ECG tests

Attach the leads to the patient

Proper lead attachment is important for a successful ECG. The most common ECG problems are caused by poor electrode contact and loose leads. Follow your local procedures for attaching the leads to the patient. Here are some common guidelines.



WARNING Electrodes can cause allergic reactions. To avoid this, follow the electrode manufacturer's directions.

To attach the leads to the patient

1. Prepare the patient.
 - Describe the procedure. Explain the importance of holding still during the test. (Movement can create artifact.)
 - Verify that the patient is comfortable, warm, and relaxed. (Shivering can create artifact.)
 - Put the patient in a reclining position with the head slightly higher than the heart and legs (the semi-Fowler's position).

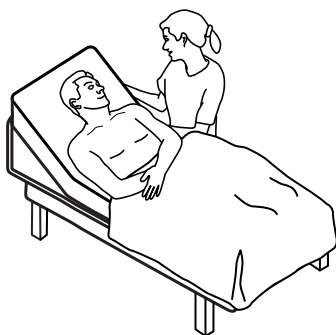

2. Select the electrode locations. (See the "Electrode locations" chart.)
 - Look for flat areas.
 - Avoid fatty areas, bony areas, and major muscles.
3. Prepare the electrode locations.
 - Shave or clip the hair.
 - Thoroughly clean the skin, and lightly rub it dry. You may use soap and water, isopropyl alcohol, or skin preparation pads.
4. Attach the lead wires to the electrodes.
5. Apply the electrodes to the patient.

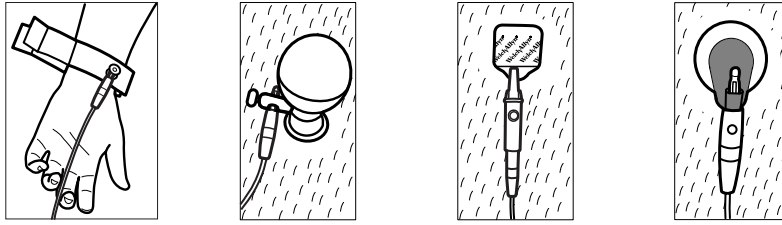

Electrode examples, left to right: arm clamp (reusable), Welsh cup (reusable), tab electrode (disposable), monitoring electrode (disposable).



- **For reusable electrodes:** Use electrode paste, gel, or cream to cover an area the size of each electrode but no larger. Secure the arm and leg clamps. Apply the Welsh cups (suction electrodes) to the chest.
- **For disposable tab electrodes:** Place the electrode tab between the “jaws” of the connector. Keep the tab flat. Verify that the metal portion of the connector makes contact with the skin side of the electrode tab.
- **For all disposable electrodes:** Lightly tug on the connector to ensure that the lead is securely attached. If the electrode comes off, replace it with a new electrode. If the connector comes off, reconnect it.

View electrode placement

1. Touch  (Electrode placement button).

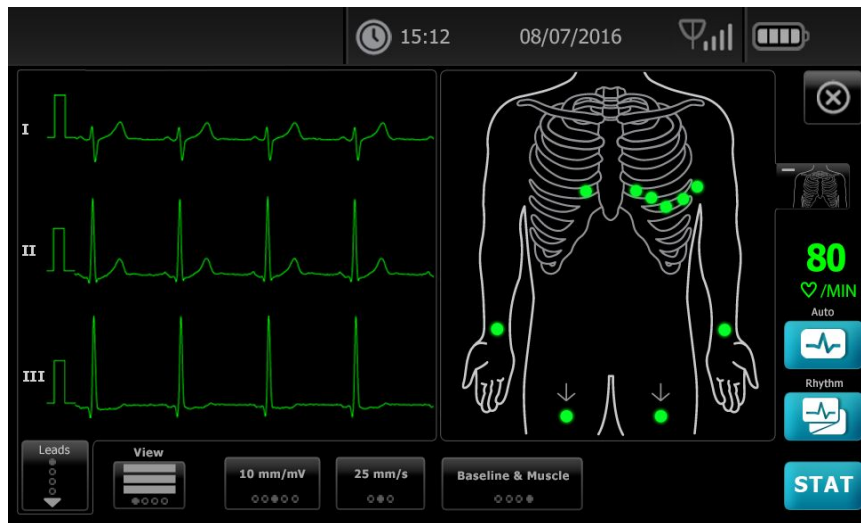
The ECG preview screen appears.



2. Touch  (torso button) to enlarge the lead placement image or touch  to close it.

Electrode locations

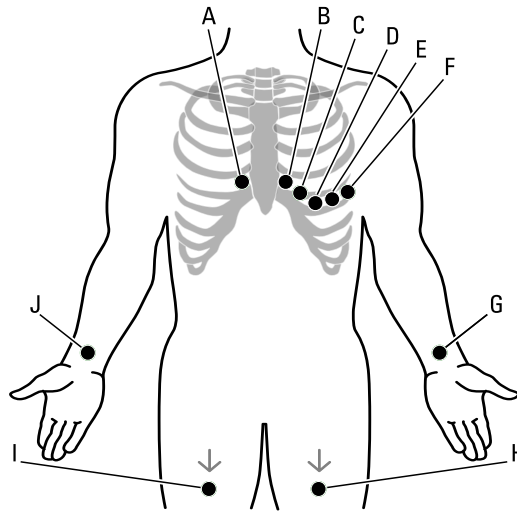

	AHA	IEC	Location
A	V1 (red)	C1 (red)	Fourth intercostal space at the right sternal border.
B	V2 (yellow)	C2 (yellow)	Fourth intercostal space at the left sternal border.
C	V3 (green)	C3 (green)	Midway between V2 and V4.
D	V4 (blue)	C4 (brown)	Fifth intercostal space to the left of the midclavicular line.
E	V5 (orange)	C5 (black)	Anterior axillary line at the same horizontal level as V4.
F	V6 (purple)	C6 (purple)	Mid-axillary line at the same horizontal level as V4 and V5.
G	LA (black)	L (yellow)	Just above the left wrist on the inside of the arm.
H	LL (red)	F (green)	Just above the left ankle.
I	RL (green)	N (black)	Just above the right ankle.
J	RA (white)	R (red)	Just above the right wrist on the inside of the arm.

Use the New Patient tab to perform an Auto ECG test



CAUTION Patient data is not saved until the ECG test is completed.

Note The ECG configuration settings can be changed in the Settings tab. The following settings may appear differently if the default settings have been modified.

Note Set the default patient entry tab to *New patient* in the Advanced settings.

1. Touch  (Auto ECG). The New patient tab appears.

Note In a connected environment, with the default patient entry tab set to *Worklist* (in the Advanced settings), the worklist is downloaded from the Worklist server workstation and the Worklist tab appears. Touch the **New patient** tab to proceed with the New patient workflow.

2. Enter the following patient information as desired:

- Patient ID. Touch **OK**.
- Birth date. Touch **OK**.
- Gender. Touch **OK**.
- Last name. Touch **OK**.
- First name. Touch **OK**.
- Middle Initial. Touch **OK**.

Note If the patient has a pacemaker touch *Pacemaker present*.

3. Touch  (Next).

4. Enter the following patient information as desired:

- Race
- Height. Touch **OK**.
- Weight. Touch **OK**.
- Physician. Touch **OK**.
- Comments. Touch **OK**.

5. Attach the leads to the patient.

6. (Optional) Adjust the waveforms, using the buttons to cycle through the following options:

- leads displayed
- ECG preview format
- gain (size)
- speed
- filters

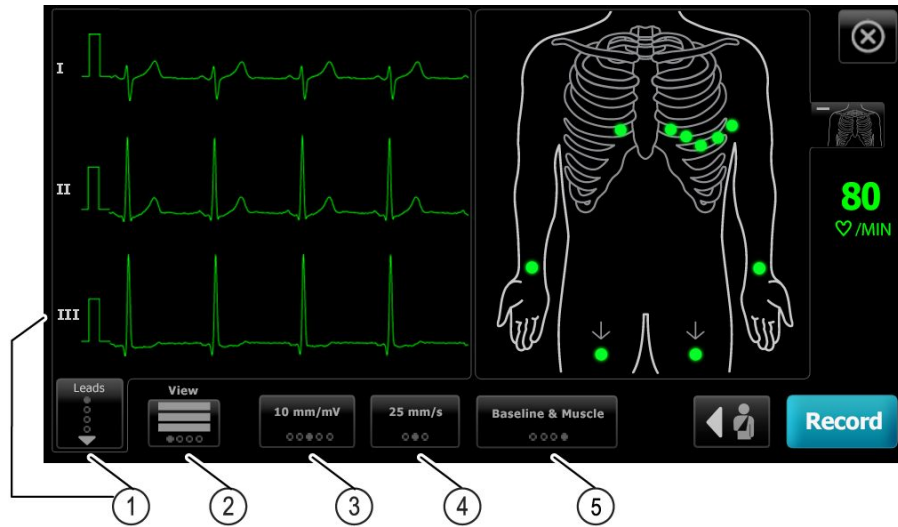

Item	Button
1	Leads button
2	ECG preview button
3	Gain button (size)
4	Speed button
5	Filters button

Note If desired, touch  (torso button) to enlarge the electrode placement (ECG preview) screen. Any flashing dots on the screen indicate unattached or poorly attached leads.

7. If an *Artifact* message appears, minimize the artifact, as described under Troubleshooting. You might need to ensure that the patient is comfortably warm, reprepare the patient's skin, use fresh electrodes, or minimize patient motion.
8. Touch **Record** to perform the Auto ECG test.
When the *Print preview* screen appears, touch **Next** to continue with the Auto ECG test or touch **Retest** to return to the previous screen.
9. If a *Waiting for 10 seconds of quality data* message appears, at least 10 seconds of ECG data have been collected with excessive artifact. Time requirements in the message may vary, based upon selected print format. Minimize the artifact, as described under Troubleshooting. Then wait for the test to record. If necessary, you can override the wait time and record the available data immediately, but the result might be an incomplete or poor-quality test.
10. After the test is completed, select the desired option: **Print**, **Save**, or **Rhythm**. If the *Auto Save* setting is turned off, touch **Save** to save the test. Select one of the following locations:
 - Local (internal memory)

- USB mass storage device (Any tests that you save to a USB mass storage device can be retrieved only from a CardioPerfect workstation.)
 - Workstation (includes DICOM image server)
 - Remote file location
11. Touch **Print** to print the test, touch **Rhythm** to start a continuous-print ECG , or touch **Exit**.



WARNING To avoid the risk of associating reports with the wrong patients, make sure that each test identifies the patient. Do not save a test to the patient record without patient identification associated with the report.

Use the Worklist tab to perform an Auto ECG test when connected to the Worklist server





CAUTION Patient data is not saved until the ECG test is completed.

- Note** The ECG configuration settings can be changed in the Settings tab. The following settings may appear differently if the default settings have been modified.
- Note** Connect the electrocardiograph to the same network as the DICOM Image server workstation and Worklist server by WiFi or Ethernet cable. If you need help, consult your network administrator.
- Note** Set the default patient entry tab to *Worklist* in the Advanced settings.

1. Touch  (Auto ECG).

The worklist is downloaded and the Worklist tab appears.

Note If the patient that you are searching for is not listed in the downloaded worklist, exit the worklist and touch  (Auto ECG) to refresh the worklist and to determine if a new order is awaiting processing from the server.

2. Touch within the Patient row to select the patient from the Worklist.
If the patient has a pacemaker touch *Pacemaker present*.
3. Touch **Select** to start a test immediately, or touch **Review** to review or edit patient information. (Optional) Touch  (Next) again.
4. Touch **Record** to perform the Auto ECG test.
5. When the *Print preview* screen appears, touch **Next** to record the test or touch **Retest** to start the test over.
6. After the test is complete, select the desired option: **Print**, **Save**, or **Rhythm**.
If you are prompted to save the Auto ECG test, select Workstation. To save to another location , touch Local, USB mass storage device, or Remote file location and touch **Save**.
7. Touch **Exit** to return to the ECG home screen, or touch **Print** to print the ECG test, or touch **Rhythm** to perform a continuous-print ECG.

Perform an Auto ECG test using the Search tab



CAUTION Patient data is not saved until the ECG test is completed.

Note The ECG configuration settings can be changed in the Settings tab. The following settings may appear differently if the default settings have been modified.

1. Touch  (Auto ECG). The New patient tab appears.
2. Search for patient.

The Search tab gives you access to patient data in the Saved tests directory or in a connected database (CardioPerfect workstation or EMR).



- Touch the **Search** tab.
- Enter the Patient ID or Last name.
- Touch **OK**.
- Touch **Search**.
- Touch within the patient row.

Note If the patient has a pacemaker touch *Pacemaker present*.

- Touch **Select** to start a test immediately.
 - Touch **Review** to review or edit patient information.
 - (Optional) Touch  (Next) again.
3. Attach the leads to the patient.
 4. Touch **Record** to perform the Auto ECG test.
 5. After the test is complete, select the desired option: **Print**, **Save**, or **Rhythm**.

If you are prompted to save the Auto ECG test, select Local, USB mass storage device, Workstation, or Remote file location. Touch **Save**.

Perform a Rhythm ECG test after an Auto ECG test

1. Touch  (Auto ECG).
2. Enter the patient information.
 - Touch  (Next) to review or edit patient information.
 - (Optional) Touch  (Next) again.
3. Attach the leads to the patient.
4. Touch **Record** to perform the Auto ECG test.
5. After the test completes, touch **Rhythm**.

If you are prompted to save the Auto ECG test, select Local, USB mass storage device, Workstation, or Remote file location. Touch **Save**.

6. Touch **Start** to begin the Rhythm ECG test.

Touch **Stop** once the desired length of real-time rhythm strips have printed.

Assign an Auto ECG test to the worklist



You can assign an Auto ECG test to the worklist if patient demographic fields are left blank.



CAUTION Patient data is not saved until the ECG test is completed.

Note If an Auto ECG test is performed without entering complete patient demographics, this test can be assigned to a patient in the worklist after the test is completed.

Note To use the assign feature the *Test assignment on* setting has to be turned on.

1. Touch  (Auto ECG). The New patient tab appears.
2. Touch  (Next).
3. (Optional) Touch  (Next).
4. Attach the leads to the patient.
5. Touch **Record** to perform the Auto ECG test.
6. When the *Print Preview* screen appears, touch **Next** to continue with the Auto ECG test or touch **Retest** to discard the test and return to the previous screen.
7. After the test completes, touch **Assign**.
8. Touch within the Patient row.
9. Touch **Select**.

If you are prompted to save the Auto ECG test, select Local, USB mass storage device, Workstation, or Remote file location. Touch **Save**.



WARNING To avoid the risk of associating reports with the wrong patients, make sure that each test identifies the patient. If any report does not identify the patient, write the patient identification information on the report immediately following the ECG test.

10. Touch **Print** to print the test, touch **Retest** to discard the test and start over, touch **Rhythm** to start a continuous-print ECG, or touch **Exit**.

Saved tests

Search for saved tests

Search for Saved Tests by:

- Date
- Last name
- Patient ID
- Test type
 - All
 - Unconfirmed
 - Unprinted
 - Unsent

Once retrieved, Saved Tests can be deleted, printed, edited, or sent to a USB storage device, Workstation, or a Remote file location.

Manage the saved tests

Saved tests are a group of ECG tests that have been saved in the electrocardiograph memory.

With all electrocardiograph models, you can delete or print saved tests. You can also do the following:

- Edit the patient data in Saved Tests.
- Send saved tests to a USB mass-storage device, a remote file location, or to the Workstation. (Any tests that you send to a USB mass-storage device can be retrieved only from a CardioPerfect workstation.)

To manage saved tests

1. Touch the **Saved tests** tab.
2. Enter data into the **Date from**, **Last name**, or **Patient ID** field, or select the check box to search the **Test Type** for **All**, **Unconfirmed**, **Unprinted**, or **Unsent** tests.
3. Touch **Search**.
4. Select a single test or multiple tests.
5. Touch **Delete**, **Print**, **Edit**, or **Send** to manage the saved tests.

Manage worklist

Download the worklist when connected to the Worklist server

The worklist is a group of patients whose demographic data has been downloaded into the electrocardiograph memory to be recalled for a test later that day. The worklist holds up to 50 patients.

When you perform an auto ECG, you can fill in the patient's data from the Worklist server.

Note The ECG configuration settings can be changed in the Settings tab. The following settings may appear differently if the default settings have been modified.

Note Set the default patient entry tab to *Worklist* in the Advanced settings.

When the electrocardiograph is connected to the Worklist server, the worklist is downloaded when you touch  (Auto ECG).

To manage the worklist

1. Touch **Manage worklist**.
2. Touch **Download**.
3. (Optional). Select a patient, or patients, from the list and touch **Delete** to delete those patients from the worklist.

Note When connected to the Worklist server, patients cannot be added manually so *Add* is not active.

Settings

View or change the ECG settings

The ECG settings control the content and format of your reports. These settings include a second Auto report format (Auto report) and a Rhythm format (Rhythm report), customizable patient data fields, and auto save options.

To view or change the settings

1. Touch the **Settings** tab. The ECG tab and the vertical ECG configuration tab appear.

Modify the settings as desired:

Note The following settings are saved as they are selected.

- Waveform centering on
- Baseline filter on
- Muscle filter on
- Save reminder on
- Default gain
- QTc method

Touch  (Next).

Modify the settings as desired:

- Electrode labels
- Electrode configuration
- ECG interval
- Lead timing

Touch  (Next).

Modify the settings as desired:

- Test assignment on
- Test assignment reminder on
- ECG preview arrangement

Touch the **Rhythm report** tab.

Modify the settings as desired:

- Default speed
- Print options

Touch  (Next).

Modify the settings as desired:

- Rhythm leads 1 - 12

Touch the **Auto report** tab.

Modify the settings as desired:

- Report format
- Average cycles
- Print report automatically
- Rhythm leads 1 - 3

Touch  (Next).

Modify the settings as desired:

- First name
- Abnormal ECG
- Unconfirmed report
- Interpretation
- Middle Initial
- Height
- Weight
- Race

Select:

- Age or Birth date

Note DICOM-enabled connectivity requires a patient's birth date. The Age/Birth date selection is disabled, the default setting becomes Birth date, once DICOM is activated,. The Age/ Birth date selection is active if the DICOM option is not installed or if it is disabled.

Touch  (Next).

Modify the settings as desired:

- Extended measurements
- MEANS reason statements (optional purchase)
- Comments
- Physician

View or change the device information

To view or change the device information

1. Touch the **Settings** tab. The ECG tab appears.
2. Touch the **Device** tab.

Modify the settings as desired:

- LCD brightness
- Date
- Time
- Adjust clock for daylight savings time

Touch **Power down** to turn off the device.

Advanced settings

The Advanced tab provides password-protected access to the CP150's Advanced settings (or Admin mode), enabling administrators, biomedical engineers, and/or service engineers to configure specific features. The Advanced tab also presents read-only information about the CP150.

Access Advanced settings

Note You cannot access Advanced settings if a patient test is in progress.

1. From the **ECG Home** tab, touch the **Settings** tab.
2. Touch the **Advanced** tab.
3. Enter 6345 as the access code and touch **OK**.

The General tab appears at the bottom of the screen and the Regional tab appears at the top of the screen.

4. Do one of the following:
 - To continue in the Advanced Settings, touch another tab.
 - To exit the Advanced Settings and return to the ECG Home tab, touch **Exit**. The ECG Home tab appears.

Regional

Specify regional settings

1. Access the Advanced Settings.
 - a. Touch the **Settings** tab.
 - b. Touch the **Advanced** tab.
 - c. Enter the **Advanced settings code**.
 - d. Touch **OK**.

The General tab appears at the bottom of the screen and the Regional tab appears at the top of the screen.

2. Specify settings.

Setting

Date format

Time format

Action/Description

Select a date format for display.

Select 12 hour display with AM/PM or 24 hour display.

Time zone	Select your time zone offset from Coordinated Universal Time (UTC).
Daylight savings offset	Select daylight savings time.
Automatically adjust clock for daylight savings time, reported by Connex	Select this to adjust the displayed time by +/- one hour when the connected host reports daylight savings time.
Height	Select centimeters, feet and inches, or inches.
Weight	Select kilograms or pounds.
Mains (AC) frequency	Select 50 hertz or 60 hertz.
Language	Select the device language.

3. Do one of the following:
 - To continue in the Advanced Settings, touch another tab.
 - To exit the Advanced Settings and return to the Home tab, touch **Exit**.

Device

Specify the device settings

1. Access the Advanced Settings.
 - a. Touch the **Settings** tab.
 - b. Touch the **Advanced** tab.
 - c. Enter the **Advanced settings code**.
 - d. Touch **OK**.

The General tab appears at the bottom of the screen and the Regional tab appears at the top of the screen.
2. Touch the **Device** tab.
 - From the Printer drop-down menu, select a PDF or printer option from the list:
 - Internal
 - PDF to USB
 - PDF to remote file location
 - Internal and PDF to USB
 - Internal and PDF to remote file location
 - From the Default patient entry drop-down menu, select New Patient or Worklist.
 - Select or deselect the HR beep on.
 - Select or deselect the Error beep on.
 - Turn Caps lock on or off.
3. Do one of the following:
 - To continue in the Advanced Settings, touch another tab.
 - To exit the Advanced Settings and return to the Home tab, touch **Exit**.

Data management

Specify data management settings

1. Access the Advanced Settings.
 - a. Touch the **Settings** tab.
 - b. Touch the **Advanced** tab.
 - c. Enter the **Advanced settings code**.
 - d. Touch **OK**.

The General tab appears on the bottom of the screen and the Regional tab appears on the top of the screen.

2. Touch the **Data Management** tab.
3. Specify settings.

Setting

Auto save preferences

Data conflict (Memory full) options

PDF name format

Remote file location

Action/Description

Set the default location for Auto save. **Off, Local, USB mass storage device, Workstation, or Remote file location.**

Set the Memory full options to **Delete Oldest** test or **Prompt user** for test deletion preferences.

Select up to four types of identification labels for display on the PDF : **None, Test type, Patient ID, Last name, Test date, Test ID, or Order ID.**

Select a delimiter: -, _, #, %, ^

Use the keyboard to add the remote file server address, user ID, and password.

Touch **Test remote folder** to test the server connection.

4. Do one of the following:
 - To continue in the Advanced Settings, touch another tab.
 - To exit the Advanced Settings and return to the Home tab, touch **Exit**.

Ownership

Specify ownership settings

1. Access the Advanced Settings.
 - a. Touch the **Settings** tab.
 - b. Touch the **Advanced** tab.
 - c. Enter the **Advanced settings code**.
 - d. Touch **OK**.

The General tab appears on the bottom of the screen and the Regional tab appears on the top of the screen.

2. Touch the **Ownership** tab.
3. Specify settings.

Setting	Action/Description
Practice ID	Use the keyboard to add the Practice identification. Touch OK .
Contact information	Use the keyboard to add the Contact information. Touch OK .
Device ID	Use the keyboard to add Device identification. Touch OK .

4. Do one of the following:
 - To continue in the Advanced Settings, touch another tab.
 - To exit the Advanced Settings and return to the Home tab, touch **Exit**.

Start Demo

Start the demo mode

1. Access the Advanced Settings.
 - a. Touch the **Settings** tab.
 - b. Touch the **Advanced** tab.
 - c. Enter the **Advanced settings code**.
 - d. Touch **OK**.

The General tab appears on the bottom of the screen and the Regional tab appears on the top of the screen.

2. Touch the **Demo** tab.
3. Touch **Start Demo** to put the CP150 in demonstration mode.

Once the demonstration mode is complete, the device returns to the Home tab.

Network

View advanced CP150 information

The Advanced Settings screen shows the CP150's software version, battery charge state, Ethernet and wireless radio MAC and IP addresses, network, server and access point information, session information, and more.

View Radio and Ethernet status

Note This task is applicable only to devices that have a radio installed and an activated license.

1. Access the Advanced Settings.
 - a. Touch the **Settings** tab.
 - b. Touch the **Advanced** tab.
 - c. Enter the **Advanced settings code**.
 - d. Touch **OK**.

The General tab appears at the bottom of the screen and the Regional tab appears at the top of the screen.

2. Touch the **Network** tab.

The Status tab appears at the top of the screen.

3. Touch the vertical **Radio** or **Ethernet** tab to view the wireless Radio or Ethernet IP, MAC address, and Status information.
4. Touch  (Next) to view more Ethernet or Radio information settings.

Information in the Status tab updates only when the device is connected to a wired or wireless network.

5. Do one of the following:
 - To continue in the Advanced Settings, touch another tab.
 - To exit the Advanced Settings and return to the Home tab, touch **Exit**.

Specify Ethernet settings

You can connect a CP150 electrocardiograph to a Welch Allyn CardioPerfect workstation or a network server via an Ethernet cable. Software provided in the CP 50/150 connectivity kit is required to communicate with the workstation. Cables longer than 3 meters have not been verified for use with the electrocardiograph. Do not use cables longer than 3 meters.

1. Access the Advanced Settings.
 - a. Touch the **Settings** tab.
 - b. Touch the **Advanced** tab.
 - c. Enter the **Advanced settings code**.
 - d. Touch **OK**.

The General tab appears at the bottom of the screen and the Regional tab appears at the top of the screen.

If connecting the CP150 electrocardiograph to a Welch Allyn CardioPerfect workstation, connect the electrocardiograph to the same network as the workstation. If you need help, consult your network administrator.

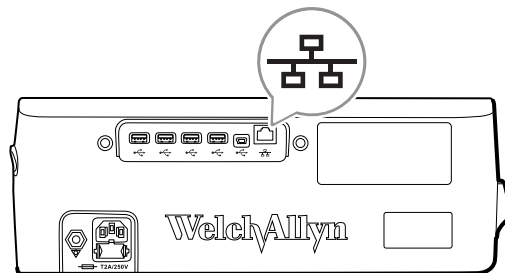





2. Touch the **Network** tab.
3. Touch the **Ethernet** tab.
4. Specify settings.

Setting

DHCP

Action/Description

Select or deselect DHCP. Select DHCP to auto-connect through Ethernet. Deselect DHCP to manually enter settings.

Network IP address	Touch  and enter the IP address to manually set up the device for Ethernet communications.
Subnet mask	Touch  and enter the Subnet mask.
Gateway	IP address that routes packets to other networks. Touch  and enter the Gateway address.
DNS Server 1	IP address of a server running DNS services for locating computers and services through user-friendly names. Touch  and enter the DNS Server address.
DNS Server 2	Touch  and enter the DNS Server 2 address.

- Do one of the following:
 - To continue in the Advanced Settings, touch another tab.
 - To exit the Advanced Settings and return to the Home tab, touch **Exit**.

Specify radio settings

Note Your model might not contain all of these features.

Note Radio features are enabled through hardware detection.

- Access the Advanced Settings.
 - Touch the **Settings** tab.
 - Touch the **Advanced** tab.
 - Enter the **Advanced settings code**.
 - Touch **OK**.

The General tab appears at the bottom of the screen and the Regional tab appears at the top of the screen.

- Touch the **Network** tab.

The Status tab appears at the top of the screen and the vertical Ethernet and Radio tabs appear.

- Touch the **Radio** tab to access WiFi and Radio settings.
- Specify Radio Configuration settings.

Setting	Action/Description
Enable radio	Enable the radio for device communications. When disabled, the radio is not available.
ESSID	Identification name of an 80211 wireless network. Touch  and enter the service set identifier (SSID- the name of the access point). Enter a maximum of 32 characters.
Radio band	Select the radio band. ABGN, ABG, AN or A.
Update radio	Touch Update radio to activate all new radio settings not selected previously. Note None of the changed radio settings take effect until you touch Update radio.

5. Do one of the following:
 - To continue in the Advanced Settings, touch another tab.
 - To exit the Advanced Settings and return to the Home tab, touch **Exit**.

Specify radio security settings

Note Your model might not contain all of these features.

1. In Advanced settings, touch the **Network > Radio > Security** tabs.
2. Select the encryption method to secure data transfer from the device.

Note Network server certificates are required for all EAP security options. Use the Welch Allyn Service Tool to load these certificates.

3. Specify Security settings.

Setting

Authentication type

WEP 64

WEP 128

WPA-Personal and WPA2-Personal

WPA-Enterprise and WPA2-Enterprise

Anonymous identity

User name

Password

Enable server validation

Update certificate

EAP type

Roaming

Update radio

Action/Description

Select the preferred encryption option. Then specify any additional settings that appear. The default encryption option is **WPA2-Personal**.

Select a WEP key and then enter a 10-character key in the selected field. Repeat this process to create multiple WEP keys. Then click **Update radio**.

Select a WEP key and then enter a 26-character key in the selected field. Repeat this process to create multiple WEP keys. Then click **Update radio**.

Enter a **Passphrase** (8 to 63 characters) then click **Update radio**. After the characters are entered they appear as asterisks.

Touch  (Next) to specify the following settings and then click **Update radio** when finished.

Encrypt user identity when authenticating with the server. This is disabled for TLS and TTLS.

Enter the EAP identity (maximum of 64 characters).

Enter the EAP password (maximum of 64 characters). This is disabled for EAP type TLS and for TLS type PEAP-TLS.

Enable or disable server validation. This is disabled for EAP type EAP-FAST.

Touch **Update certificate** to update radio certificates settings from a USB drive.

Note The USB drive needs to contain the file *waclientcert.pim* within a folder entitled *Certs*.

Select the authentication protocol. Select more specific EAP settings (Inner EAP Setting, PAC Provisioning).

PMK, OKC, CCKM

Touch **Update radio** to activate all new radio settings not selected previously. Touch **OK** in the confirmation popup.

Note None of the changed radio settings take effect until you touch *Update radio*.

4. Do one of the following:
 - To continue in Advanced settings, touch another tab.
 - To exit Advanced settings and return to the Home tab, touch **Exit**.

Specify TCP/IP settings

Note Your model might not contain all of these features.

Note This task is applicable only to devices that have a radio installed and an activated license.

1. In Advanced settings, touch the **Network** > **TPC/IP** tabs.
2. Specify TCP/IP settings.

Setting

DHCP

Network IP address

Subnet mask

Gateway

DNS Server 1

DNS Server 2

Update radio

Action/Description

Select or deselect DHCP. Select DHCP to auto-connect through TCP/IP. Deselect DHCP to manually enter settings.

Touch  and enter the IP address to manually set up the device for TCP/IP communications.

Touch  and enter the Subnet mask.

IP address that routes packets to other networks. Touch  and enter the Gateway address.

IP address of a server running DNS services for locating computers and services through user-friendly names.

Touch  and enter the DNS Server address.

Touch  and enter the DNS Server 2 address.

Touch **Update radio** to activate all new radio settings not selected previously. Touch **OK** in the confirmation popup.

Note None of the changed radio settings take effect until you touch **Update radio**.

3. Do one of the following:
 - To continue in Advanced settings, touch another tab.
 - To exit Advanced settings and return to the Home tab, touch **Exit**.

Specify Server settings

1. Access the Advanced Settings.
 - a. Touch the **Settings** tab.
 - b. Touch the **Advanced** tab.
 - c. Enter the **Advanced settings code**.



- d. Touch **OK**.

The General tab appears at the bottom of the screen and the Regional tab appears at the top of the screen.

2. Touch the **Network** tab.
3. Touch the **Server** tab.

The Connex and DICOM vertical tabs appear.

4. Touch the **Connex** tab to specify the Connex settings.

Setting	Action/Description
UDP Broadcast port	Enable the device to broadcast a request to obtain an IP address for a selected service. Specify the port to match the port used by the server. Touch  in the UDP broadcast port entry field and enter the port number. The range of entry is 0 to 65535.
Obtain sever IP address automatically	Select this option to obtain sever IP address automatically. Deselect to manfully enter settings.
DCP IP address	Specify a fixed IP address for CardiPerfect workstation or other servers. Touch  in the server IP address fields and enter the IP address.
Port	Select the port. Touch  in the Port entry field and enter the port number. The range of entry is 0 to 65535.
Test Connection	Touch Test Connection to test the connection to the configured server.

5. Do one of the following:
 - To continue in the Advanced Settings, touch another tab.
 - To exit the Advanced Settings and return to the Home tab, touch **Exit**.

Specify the DICOM Worklist and Image Server settings

Note Your model might not contain all of these features.

Note This task is applicable only to devices that have an activated DICOM license.

1. Access the Advanced Settings.
 - a. Touch the **Settings** tab.
 - b. Touch the **Advanced** tab.
 - c. Enter the **Advanced settings code**.
 - d. Touch **OK**.

The General tab appears at the bottom of the screen and the Regional tab appears at the top of the screen.

2. Touch the **Network** tab.
3. Touch the **Server** tab.

The Connex and DICOM vertical tabs appear.

4. Touch the **DICOM** tab to specify the DICOM settings.

Setting

Enable worklist downloads and ECG DICOM uploads

Action/Description

Select this option to enable DICOM functionality.

Local AE Title

Touch  and enter the AE Title for the device (Example: CP150). Enter a maximum of 16 characters.

5. Touch  (Next) to view more DICOM Worklist Server settings. The DICOM Worklist Server configuration settings appear.

Setting

Server AE Title

Action/Description

Touch  and enter the AE Title for the server. Enter a maximum of 16 characters.

IP address

Touch  in the server IP address fields and enter the IP address.

Port

Select the port. Touch  in the Port entry field and enter the port number. (The port number is set by the network administrator.)

Location filter

Use the drop-down menu to turn the filter off. Or filter by Local AE Title or Device ID / Practice ID.

Test Connection

Touch **Test Connection** to test the connection to the DICOM Worklist Server.

6. Touch  (Next) to view the DICOM Image Server settings. The DICOM Image Server configuration settings appear.
7. Connect to the DICOM Image Server.

Setting

Server AE Title

Action/Description

Touch  and enter the AE Title for the DICOM Image Server. Enter a maximum of 16 characters.

IP address

Touch  in the server IP address fields and enter the IP address.

Port

Select the port. Touch  in the Port entry field and enter the port number. (The port number is set by the network administrator.)

ECG waveform storage

Select 12-Lead or General waveform storage format.

Note When the selected ECG waveform is set to the 12-Lead format, storage reverts to the General waveform if the number of samples is larger than permitted for the 12-Lead format. The 12-Lead storage reverts to the General waveform only if the Auto Report is set to one of the 3x4 formats with the 5-second option and the ECG test is for a pediatric patient.

Coding scheme

Select SCPECG or MDC.

Note See the CP150 Conformance Statement for Coding scheme definitions.

Test Connection

Touch **Test Connection** to test the connection to the DICOM Image Server.

8. Do one of the following:
 - To continue in the Advanced Settings, touch another tab.
 - To exit the Advanced Settings and return to the Home tab, touch **Exit**.

Service

The Service tab presents numerous settings and controls typically accessed by authorized service or biomedical engineering personnel to configure, maintain, test, and update the device. For example, the Service tab enables authorized users to save device configurations to a USB flash drive and then load saved configurations to other devices. Systems and devices configured with the PartnerConnect™ service feature also have access to remote diagnostics, troubleshooting, and software upgrades.

For a description of service-related advanced settings, see the service manual for this product.

View or change the Service settings

To view or change the settings

1. From the **ECG Home** tab, touch the **Settings** tab.
2. Touch the **Advanced** tab.
3. Enter 6345 as the access code and touch **OK**. The General tab appears at the bottom of the screen and the Regional tab appears at the top of the screen.
4. Touch the **Service** tab.

Restore factory defaults

Note Your model might not contain all of these features.

- All settings
- Printer page count
- Calibration gain
- Radio settings

Device configuration

- Save to USB
- Configure from USB
- Print all settings

Update software

- Update

Upgrade your existing CP 150 device software version through the Welch Allyn Service Tool

Note A USB cable is required to perform the software upgrade.

Note Connect the CP 150 to an AC power outlet before upgrading the software.

1. Download the Welch Allyn Service Tool and Partner Connect and install on your PC.
2. Follow the instructions to set up a user name and password.

3. Plug your CP 150 device into a USB port on your PC running the Welch Allyn Service Tool and turn on the device. Plug your CP 150 device into AC power.
4. If the Welch Allyn Service Tool is not still open, go to the Windows Start menu, and then select **All Programs > Welch Allyn > Welch Allyn Service Tool**.
5. Log in to the Welch Allyn Service Tool.
6. Highlight the CP150 to select it from the Device list.
7. Click **Select**.

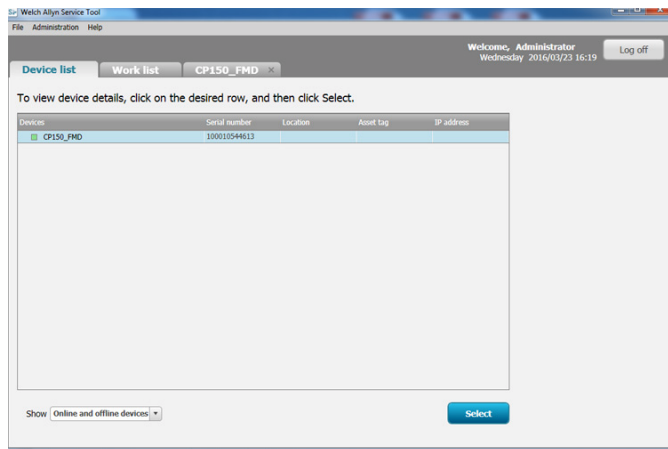

8. Click the **Upgrade** tab and then click **Check for new upgrades**.

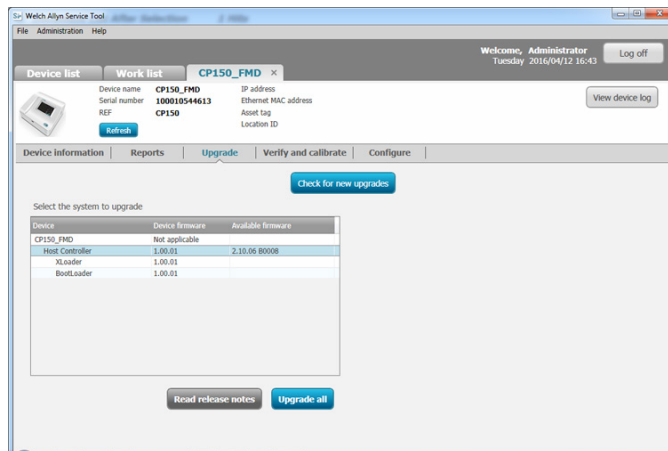

9. Highlight the device software (for example, the firmware Host Controller 2.XX.XX) to select it from the list.

The device's current software (firmware) version shows in the *Device firmware* column and the latest available version shows in the *Available firmware* column.

10. Click **Upgrade all**. Optional, click **Read release notes** to view upgrade details.
11. At the *Upgrade Host Controller* screen, click **Yes** at the prompt: Do you want to continue?



CAUTION Do not power off the CP 150 device during the update.

Note The upgrade process may take up to fifteen minutes to cycle through the complete upgrade. During the upgrade process, the progress indicator shows the percentage complete status, however, it is also normal to see both a blank screen and a reboot screen that appear several times before the CP 150 device automatically reboots.

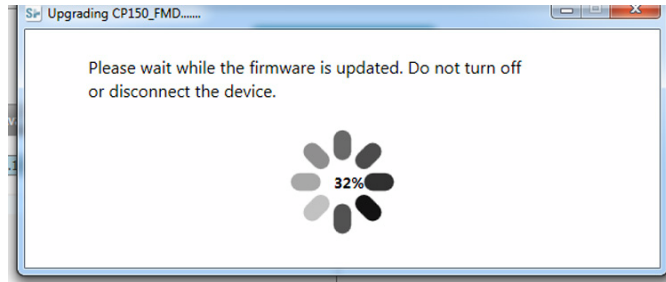

Activate the DICOM license through the Welch Allyn Service Tool

Note A USB cable is required to perform the DICOM upgrade.

Note Contact Welch Allyn to purchase the DICOM license. DICOM installation requires a DICOM license that needs to be authorized through the Welch Allyn Service Tool. When you purchase a licensed upgrade or option for a supported product, you also receive an authorization code from Welch Allyn. Use this code to activate the new feature or features.

1. Download the Welch Allyn Service Tool and Partner Connect and install on your PC.
2. Plug your CP 150 device into a USB port on your PC running the Welch Allyn Service Tool and turn on the device.
3. If the Welch Allyn Service Tool is not still open, go to the Windows Start menu, and then select **All Programs > Welch Allyn > Welch Allyn Service Tool**.
4. Click **Add new features**.

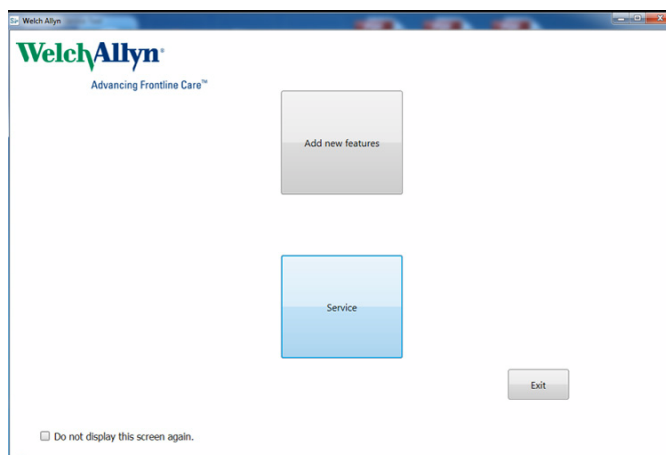

5. Enter the DICOM code into the authorization code field.
6. Click **Activate**.

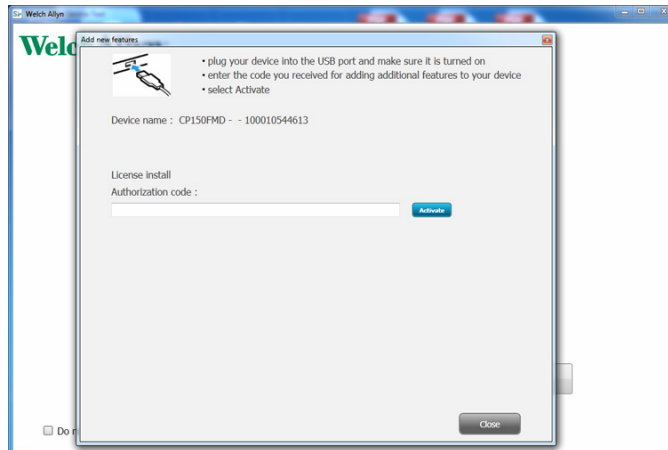

At the *Install License* screen, click **OK**.



CAUTION Do not disconnect or power off the device during the license installation.

7. Once you see the *Add new features* screen confirming the license installation, click **Close**.

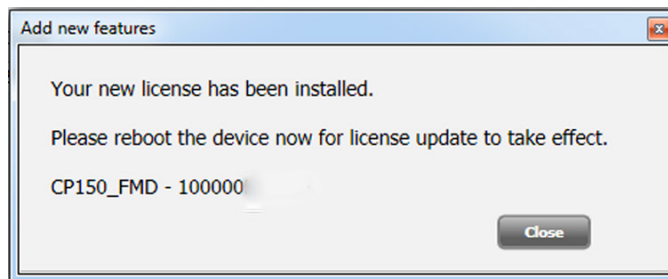

8. For the license upgrade to take effect, press and hold the power button for about 8 seconds to reboot the device.

Maintenance

Cleaning the equipment



WARNING Keep the electrocardiograph, reusable electrodes, and the patient cable clean. Patient contact with contaminated equipment can spread infection.



CAUTION Never let soap or water come into contact with the electrocardiograph's internal printer, connectors, or jacks.



CAUTION Never immerse the electrocardiograph or the patient cable in liquid. Never autoclave or steam clean the electrocardiograph or the patient cable. Never pour alcohol directly on the electrocardiograph or the patient cable, and never soak any components in alcohol. If any liquid enters the electrocardiograph, remove the electrocardiograph from service, and have it inspected by a qualified service person before using it again.

Note The patient cables should be cleaned after each use.

Clean on a routine basis according to your facility's protocols and standards or local regulations.

The following agents are compatible with the electrocardiograph:

- 70 percent isopropyl alcohol
- 10 percent chlorine bleach solution



CAUTION When cleaning the device, avoid using cloths or solutions that include quaternary ammonium compounds (ammonium chlorides) or glutaraldehyde-based disinfectants.



Note Disinfect according to your facility's protocols and standards or local regulations.

To clean the equipment (monthly or more often if needed)

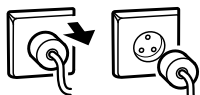
1.



Disconnect the power plug from the AC outlet.

-
2.  Turn off the electrocardiograph. (Press and hold the power button for at least six seconds until the screen goes blank.)
-
3.  Dampen a cloth with any of the acceptable cleaning solutions, and wipe the exterior of the patient cable and electrocardiograph. Dry all components with a clean, soft cloth, or paper towel.
-
4.  Before you turn on the electrocardiograph again, wait at least 10 minutes for all traces of liquid to evaporate.
-

70 percent isopropyl alcohol

Wipe the electrocardiograph with a clean cloth slightly dampened with 70 percent isopropyl alcohol.

10 percent chlorine bleach solution

1. Wipe the electrocardiograph with a clean cloth slightly dampened with a 10 percent bleach and water solution. Follow the cleaning agent manufacturer's guidelines.
2. Rinse with a clean cloth slightly dampened with water that meets EP and USP quality standards.
3. Allow the electrocardiograph surface to dry for a minimum of 10 minutes before using the electrocardiograph.

Inspecting the equipment

Perform the following inspections daily.

- Check for cracked or broken patient cable, patient electrodes, power cord, communications cables, display, and enclosure.
- Check for bent or missing pins on all cables.
- Check all cable and cord connections; reseat if any connectors are loose.

Testing the electrocardiograph

Welch Allyn recommends verifying proper operation of the electrocardiograph once a year to ensure reliability. See *Verifying proper operation*.

Whenever the electrocardiograph is serviced or whenever problems are suspected, verify continued electrical safety of the device using IEC 60601-1 or ANSI/AAMI ES1 methods and limits.



WARNING Only qualified service personnel should perform leakage current tests.

Test for the following:

- Patient leakage current

- Chassis leakage current
- Earth leakage current
- Dielectric strength (AC and patient circuits)

Replacing the battery

Replace the battery under these circumstances:

- It loses its charge quickly.
- You have charged it, and the electrocardiograph still does not turn on when unplugged.

The first time that you press the power button after installing a new battery, the electrocardiograph goes through some diagnostic tests that cause it to take longer than usual to power up.

Discard the old battery appropriately. Contact your local authorities concerning recycling.

To replace the battery

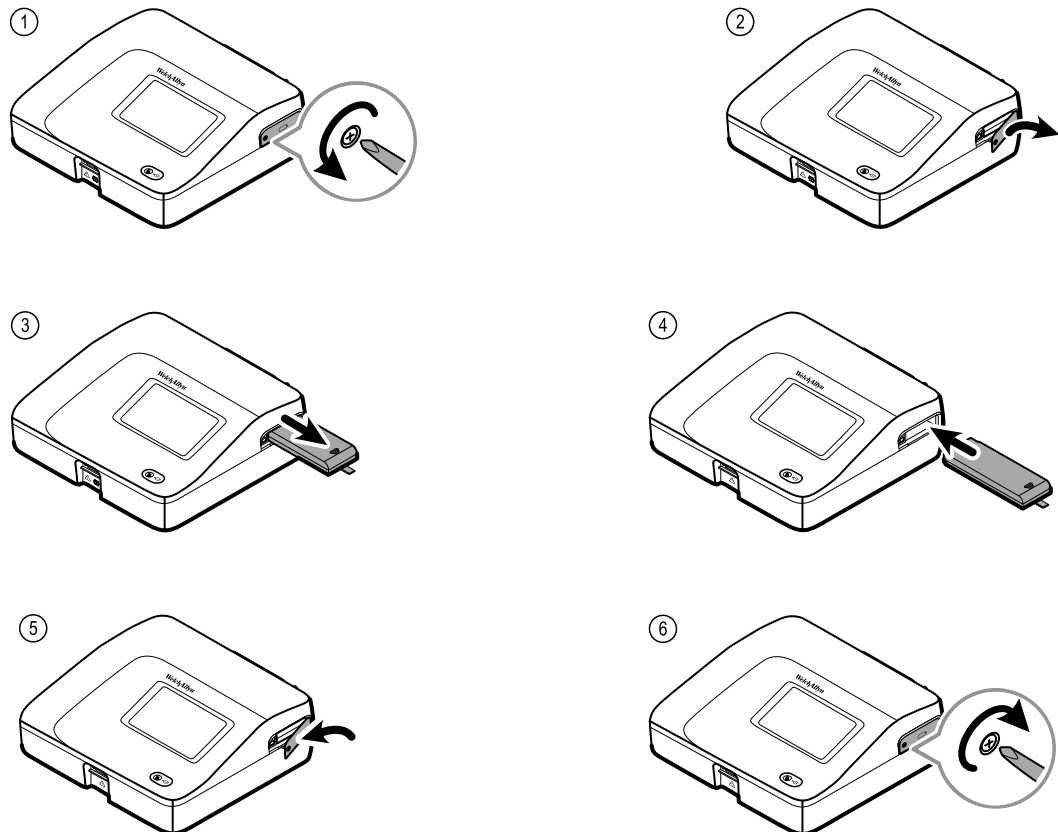

Replacing the AC fuses

You might need to replace one or both of the AC fuses if the AC power indicator does not light up when the electrocardiograph is connected to AC power.



WARNING Failure to unplug could result in electrocution.

To replace the AC fuses

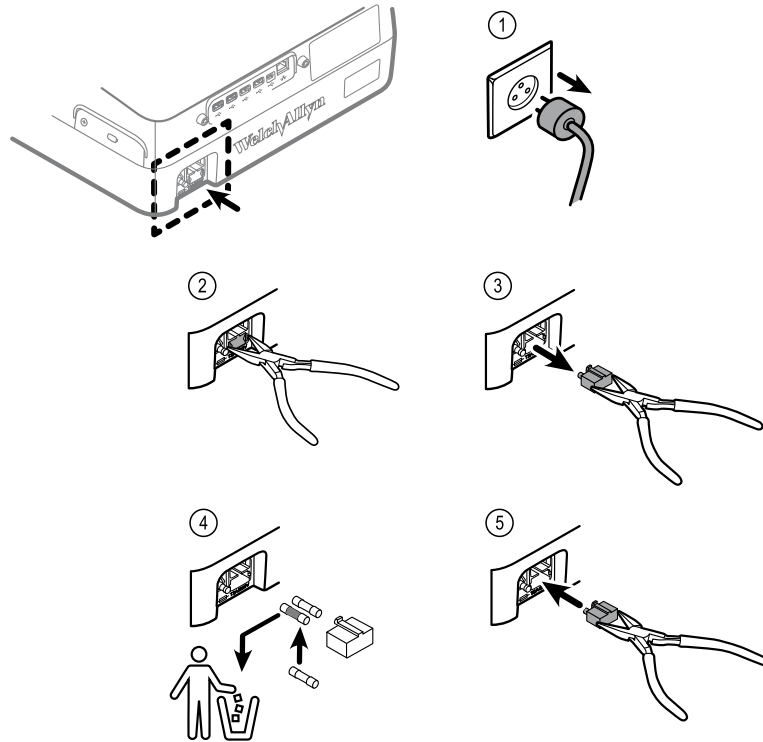

If either fuse is dark or has a broken wire, replace the fuse. Line up the fuse case with the opening; it goes in only one way.

Storing the equipment

When storing the electrocardiograph, cords, and accessories, observe the environmental storage conditions that are identified in the product specifications.

Disposing of electronic equipment



— This product and its components must be disposed of according to local laws and regulations. Do not dispose of this product as unsorted municipal waste.

For more specific disposal or compliance information, see www.welchallyn.com/weee, or contact Welch Allyn Customer Service.

Troubleshooting

Lead-quality problems

“Artifact” message on the screen

Artifact is signal distortion that makes it difficult to accurately discern the waveform morphology.

Causes

- The patient was moving.
- The patient was shivering.
- There is electrical interference.

Actions

See actions for wandering baseline, muscle tremor, and AC interference.

Wandering baseline

Wandering baseline is an upward and downward fluctuation of the waveforms.

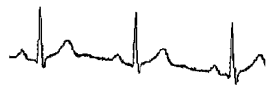

Causes

- Electrodes are dirty, corroded, loose, or positioned on bony areas.
- The electrode gel is insufficient or dried.
- The patient has oily skin or used body lotions.
- Rising and falling of chest during rapid or apprehensive breathing.

Actions

- Clean the patient's skin with alcohol or acetone.
- Reposition or replace the electrodes.
- Verify that the patient is comfortable, warm, and relaxed.
- If wandering baseline persists, turn the baseline filter on.

Muscle tremor



Causes

- The patient is uncomfortable, tense, nervous.
- The patient is cold and shivering.
- The exam bed is too narrow or short to comfortably support arms and legs.
- The arm or leg electrode straps are too tight.

Actions

- Verify that the patient is comfortable, warm, and relaxed.
- Check all electrode contacts.
- If interference persists, turn the muscle-tremor filter on. If interference still persists, the problem is probably electrical in nature. See the suggestions for reducing AC interference (in a related troubleshooting tip).

AC interference

AC interference superimposes even-peaked, regular voltage on the waveforms.



Causes

- The patient or technician was touching an electrode during recording.
- The patient was touching a metal part of an exam table or bed.
- A lead wire, patient cable, or power cord are broken.
- Electrical devices in the immediate area, or lighting, or wiring concealed in walls or floors are interfering.
- An electrical outlet is improperly grounded.
- The AC filter is turned off or set incorrectly.

Actions

- Verify that the patient is not touching any metal.
- Verify that the AC power cable is not touching the patient cable.
- Verify that the proper AC filter is selected.
- If interference persists, unplug the electrocardiograph from AC power and run it on the battery. If this solves the problem, you'll know that the noise was introduced through the power line.
- If interference still persists, the noise may be caused by other equipment in the room or by poorly grounded power lines. Try moving to another room.

Lead alert or square wave



A dot might be flashing on the lead-status screen. Or one or more leads might appear as a square wave.

Causes

- Electrode contact might be poor.
- A lead might be loose.
- A lead might be defective.

Actions

- Replace the electrode.
- Verify that the patient's skin has been properly prepared.
- Verify that electrodes have been properly stored and handled.
- Replace the patient cable.

System problems

The electrocardiograph won't turn on when it is plugged in

Causes

- The AC power connection is faulty.
- An AC fuse is blown.
- There is no AC power.

Actions

- Check the AC power source.
- Check the AC fuses.

The electrocardiograph won't turn on when it is unplugged

Causes

- The battery is disconnected or incorrectly connected.
- The battery is low, not charging, depleted, or bad.

Actions

- Check the battery connections.
- Recharge the battery.
- Replace the battery.

The electrocardiograph shuts down during printing

Causes

- The battery is low or bad.

Actions

- Recharge the battery.
- Replace the battery.

The electrocardiograph prints fewer than 10 reports on a full battery charge

Causes

- The battery is degraded.

Actions

- Replace the battery.

The electrocardiograph does not respond when you press buttons or touch the screen

Causes

- The electrocardiograph is frozen.

Actions

- Reset the electrocardiograph by pressing and holding the power button for at least six seconds until the screen goes blank. Press the power button again. The electrocardiograph goes through some diagnostic tests that cause it to take longer than usual to power up.
- Touch the **Settings** tab. Touch the **Advanced** tab. Touch the **Power down** button. The electrocardiograph goes through some diagnostic tests that cause it to take longer than usual to power up.

Note For more troubleshooting guidelines, see the service manual.



CAUTION The service manual is for use only by qualified service personnel who understand technical English.

Service policy

All repairs on products under warranty must be performed by Welch Allyn or by a service provider authorized by Welch Allyn. Unauthorized repairs will void the warranty. In addition, whether or not covered under warranty, any product repair should be performed exclusively by Welch Allyn or by a service provider that has been authorized by Welch Allyn.

If the product fails to function properly—or if you need assistance, service, or spare parts—contact the nearest Welch Allyn Technical Support Center.

Before contacting Welch Allyn, try to duplicate the problem, and check all accessories to ensure that they are not causing the problem. When calling, please be prepared to provide:

- Product name, model number, and serial number of your product.
- Complete description of the problem.
- Complete name, address and phone number of your facility.
- For out-of-warranty repairs or spare parts orders, a purchase order (or credit card) number.
- For parts orders, the required spare or replacement part numbers.

If your product requires warranty, extended warranty, or non-warranty repair service, please call first the nearest Welch Allyn Technical Support Center. A representative will assist you troubleshooting the problem and will make every effort to solve it over the phone, avoiding potential unnecessary return of your product.

In case a return cannot be avoided, the representative will record all necessary information and will provide a Return Material Authorization (RMA) number, as well as the appropriate return address. An RMA number must be obtained prior to any return.

If you have to return your product for service, follow these recommended packing instructions:

- Remove all hoses, cables, sensors, power cords, and other accessories (as appropriate) before packing, unless you suspect they are associated with the problem.
- Wherever possible use the original shipping carton and packing materials.
- Include a packing list and the Welch Allyn Return Material Authorization (RMA) number.

It is recommended that all returned goods be insured. Claims for loss or damage to the product must be initiated by the sender.

Limited warranty

Welch Allyn warrants the product to be free of defects in material and workmanship and to perform in accordance with manufacturer's specifications for the period of three years from the date of purchase from Welch Allyn or its authorized distributors or agents.

The warranty period shall start on the date of purchase. The date of purchase is: 1) the invoiced ship date if the device was purchased directly from Welch Allyn, 2) the date specified during product registration, 3) the date of purchase of the product from a Welch Allyn authorized distributor as documented from a receipt from said distributor.

This warranty does not cover damage caused by: 1) handling during shipping, 2) use or maintenance contrary to labeled instructions, 3) alteration or repair by anyone not authorized by Welch Allyn, and 4) accidents.

The product warranty is also subject to the following terms and limitations: Accessories are not covered by the warranty. Refer to the directions for use provided with individual accessories for warranty information.

Shipping cost to return a device to a Welch Allyn Service center is not included.

A service notification number must be obtained from Welch Allyn prior to returning any products or accessories to Welch Allyn's designated service centers for repair. To obtain a service notification number, contact Welch Allyn Technical Support.

THIS WARRANTY IS IN LIEU OF ALL OTHER WARRANTIES, EXPRESS OR IMPLIED, INCLUDING BUT NOT LIMITED TO THE IMPLIED WARRANTIES OF MERCHANTABILITY AND FITNESS FOR A PARTICULAR PURPOSE. WELCH ALLYN'S OBLIGATION UNDER THIS WARRANTY IS LIMITED TO REPAIR OR REPLACEMENT OF PRODUCTS CONTAINING A DEFECT. WELCH ALLYN IS NOT RESPONSIBLE FOR ANY INDIRECT OR CONSEQUENTIAL DAMAGES RESULTING FROM A PRODUCT DEFECT COVERED BY THE WARRANTY.

General compliance and standards

The CP150 complies with the following standards:

ANSI/AAMI EC11**	CAN/CSA C22.2 No. 601.1	CAN/CSA C22.2 No. 601.1.2
IEC/EN 60601-1	IEC/EN 60601-1-2	IEC/EN 60601-1-4
CAN/CSA C22.2 No. 601.1.4	CAN/CSA C22.2 No. 601.2.25	
IEC/EN 60601-1-6	IEC/EN 60601-2-25 ***	IEC/EN 60601-2-51* (3x4 report format)
ANSI/AAMI EC53	EN 50581	EN/IEC 62304
EN/IEC 62366	EN/ISO 14971	EN/ ISO 10993-1
EN/ISO 26782 (Spirometry Option)		

Declaration of Conformity

Available upon request.

Device radio



The CP 150 radio operates on 802.11 networks.

Wireless network interface	IEEE 802.11 a/b/g/n	
Frequency	2.4 GHz frequency bands	5 GHz frequency bands
	2.4 GHz to 2.483 GHz	5.15 GHz to 5.35 GHz, 5.725 GHz to 5.825GHz
Channels	2.4 GHz channels	5 GHz
	Up to 14 (3 non-overlapping); country-dependent,	Up to 23 non overlapping; country-dependent
Authentication/Encryption	Wireless Equivalent Privacy (WEP, RC4 Algorithm); Wi-Fi Protected Access (WPA); IEEE 802.11i (WPA2); TKIP, RC4 Algorithm; AES, Rijndael Algorithm; Encryption Key Provisioning; Static (40-bit and 128-bit lengths); PSK; Dynamic; EAP-FAST; EAP-TLS; EAP-TTLS; PEAP-GTC ¹ PEAP-MSCHAPv2; PEAP-TLS;	

Antenna	Ethertronics WLAN_1000146
Wireless data rates	802.11a (OFDM): 6, 9, 12, 18, 24, 36, 48, 54 Mbps
	802.11b (DSSS, CCK): 1, 2, 5.5, 11 Mbps
	802.11g (OFDM): 6, 9, 12, 18, 24, 36, 48, 54 Mbps
	802.11n (OFDM, HT20, MCS 0-7): 6.5, 13, 19.5, 26, 39, 52, 58.5, 72.2 Mbps
Protocols	UDP, DHCP, TCP/IP
Data transfer protocols	UDP/TCP/IP
Output power	39.81mW typical, country-dependent
Ancillary IEEE standards	802.11d, 802.11e, 802.11h, 802.11i, 802.11X

¹One time passwords are not supported.

Radio compliance/approvals

US	SQG-WB45NBT FCC Part 15.247 Subpart C, FCC Part 15.407 Subpart E
Europe	EN 300 328 (EDR) (v1.8.1), EN 300 328 (LE) (v1.8.1), EN 301 489-1 (v1.9.2), EN 301 489-17 (v2.2.1), EN 301 489-17 (v2.2.1), EN 62311:2008, EN 60950-1
Canada	(IC) RSS-210 standard. IC 3147A-WB45NBT based on FCC testing
Australia and New Zealand	Australian Communications and Media Authority (ACMA) Radio Compliance Mark (RCM)  New Zealand maintains a Mutual Recognition Agreement (MRA) with Australia.
Brazil	Este equipamento opera em caráter secundário, isto é, não tem direito a proteção contra interferência prejudicial, mesmo de estações do mesmo tipo, e não pode causar interferência a sistemas operando em caráter primário.  MODELO: WB45NBT 1130-15-8547 ANATEL Model No. 1130-15-8547 07898949039068
Mexico	Instituto Federal de Telecomunicaciones (Federal Telecommunications Institute—IFETEL) This product contains an Approved module, Model No. WB45NBT IFETEL No. RCPLAWB14-2006
Singapore	Infocomm Development Authority of Singapore (IDA) (新加坡资讯通信发展管理局) This device contains an IDA approved device.
South Korea	Korea Communications Commission (대한민국 방송통신위원회) - KCC Certification number: MSIP-CRM-LAI-WB45NBT  This device complies with Article 58-2 Radio Waves Act of Korea Communications

Commission. This equipment is Industrial (Class A) electromagnetic wave suitability equipment and seller or user should take notice of it, and this equipment is to be used in the places except for home.

Class A Equipment (Industrial Broadcasting & Communication Equipment) A 급 기기 (업무용 방송통신기자재)

이 기기는 업무용 (A 급) 전자파적합 기기로서 판매자 또는 사용자는 이 점을 주의하시기 바라며, 가정외의 지역에서 사용하는 것을 목적으로 합니다.

Channel restrictions in the 5-GHz band are determined by country.

To ensure compliance with local regulations, be sure the correct country in which the access point is installed is selected. This product can be used with the following restriction(s):

Norway - Does not apply for the geographical area within a radius of 20 km from the center of Ny-Ålesund.

France - Outdoor use is limited to 10 mW EIRP within the band 2454 to 2483.5 MHz.

Note Effective Isotropic Radiated Power (EIRP).

Note Some countries restrict the use of 5-GHz bands. The 802.11a radio in the CP 150 uses only the channels indicated by the access point with which the radio associates. The hospital IT department must configure access points to operate with approved domains.

General radio compliance

The wireless features of this device must be used in strict accordance with the manufacturer's instructions as described in the user documentation that comes with the device.

This device complies with Part 15 of the FCC rules and with the rules of the Canadian ICES-003 as described below.

Federal Communications Commission (FCC)

This device complies with part 15 of the FCC Rules. Operation is subject to the following two conditions:

- This device may not cause harmful interference.
- This device must accept any interference received, including interference that may cause undesired operation.

This equipment has been tested and found to comply with the limits for a Class B digital device, pursuant to Part 15 of FCC Rules. These limits are designed to provide reasonable protection against harmful interference in a residential installation. This equipment generates, uses, and can radiate radio frequency energy. If not installed and used in accordance with the instructions, it may cause harmful interference to radio communications. However, there is no guarantee that interference will not occur in a particular installation. If this equipment does cause harmful interference to radio or television reception, which can be determined by turning the equipment off and on, the user is encouraged to try and correct the interference by one or more of the following measures:

- Reorient or relocate the receiving antenna

- Increase the distance between the equipment and the receiver
- Connect the equipment to an outlet on a circuit different from that to which the receiver is connected
- Consult the dealer or an experienced radio/TV technician for help

The user may find the following booklet prepared by the Federal Communications Commission helpful:

The Interference Handbook

This booklet is available from the U.S. Government Printing Office, Washington, D.C. 20402. Stock No. 004-000-0034504.

Welch Allyn is not responsible for any radio or television interference caused by unauthorized modification of the devices included with this Welch Allyn product, or the substitution or attachment of connecting cables and equipment other than specified by Welch Allyn.

The correction of interference caused by such unauthorized modification, substitution, or attachment will be the responsibility of the user.

Industry Canada (IC) emissions

This device complies with RSS 210 of Industry Canada.

Operation is subject to the following two conditions: (1) this device may not cause interference, and (2) this device must accept any interference, including interference that may cause undesired operation of this device.

L'utilisation de ce dispositif est autorisée seulement aux conditions suivantes: (1) il ne doit pas produire de brouillage et (2) l'utilisateur du dispositif doit être prêt à accepter tout brouillage radioélectrique reçu, même si ce brouillage est susceptible de compromettre le fonctionnement du dispositif.

This Class B digital apparatus complies with Canadian ICES-003.

Cet appareil numérique de la classe B est conforme à la norme NMB-003 du Canada.

RF Radiation Hazard Warning

Using higher gain antennas and types of antennas not certified for use with this product is not allowed. The device shall not be co-located with another transmitter.

Cet avertissement de sécurité est conforme aux limites d'exposition définies par la norme CNR-102 relative aux fréquences radio.

This radio transmitter (Contains IC ID: 3147A-WB45NBT) has been approved by Industry Canada to operate with the antenna types listed in table above with the maximum permissible gain and required antenna impedance for each antenna type indicated. Antenna types not included in this list, having a gain greater than the maximum gain indicated for that type, are strictly prohibited for use with this device.

Le présent émetteur radio (Contient l'ID IC: 3147A-WB45NBT) a été approuvé par Industrie Canada pour fonctionner avec les types d'antenne énumérés ci-dessous et ayant un gain admissible maximal et l'impédance requise pour chaque type d'antenne. Les types d'antenne non inclus dans cette liste, ou dont le gain est supérieur au gain maximal indiqué, sont strictement interdits pour l'exploitation de l'émetteur.

Under Industry Canada regulations, this radio transmitter may only operate using an antenna of a type and maximum (or lesser) gain approved for the transmitter by Industry Canada. To reduce potential radio interference to other users, the antenna type and its gain should be so chosen that the equivalent isotropically radiated power (e.i.r.p.) is not more than that necessary for successful communication.

Conformément à la réglementation d'Industrie Canada, le présent émetteur radio peut fonctionner avec une antenne d'un type et d'un gain maximal (ou inférieur) approuvé pour l'émetteur par Industrie Canada. Dans le but de réduire les risques de brouillage radioélectrique à l'intention des autres utilisateurs, il faut choisir le type d'antenne et son gain de sorte que la puissance isotrope rayonnée équivalente (p.i.r.e.) ne dépasse pas l'intensité nécessaire à l'établissement d'une communication satisfaisante.

This device complies with Industry Canada license-exempt RSS standard(s). Operation is subject to the following two conditions: (1) this device may not cause interference, and (2) this device must accept any interference, including interference that may cause undesired operation of the device.

Le présent appareil est conforme aux CNR d'Industrie Canada applicables aux appareils radio exempts de licence. L'exploitation est autorisée aux deux conditions suivantes : (1) l'appareil ne doit pas produire de brouillage, et (2) l'utilisateur de l'appareil doit accepter tout brouillage radioélectrique subi, même si le brouillage est susceptible d'en compromettre le fonctionnement.

European Union

Czech	Welch Allyn tímto prohlašuje, že tento RLAN device je ve shodě se základními požadavky a dalšími příslušnými ustanoveními směrnice 1999/5/ES.
Danish	Undertegnede Welch Allyn erklærer herved, at følgende udstyr RLAN device overholder de væsentlige krav og øvrige relevante krav i direktiv 1999/5/EF
Dutch	Bij deze verklaart Welch Allyn dat deze RLAN device voldoet aan de essentiële eisen en aan de overige relevante bepalingen van Richtlijn 1999/5/EC.
English	Hereby, Welch Allyn, declares that this RLAN device is in compliance with the essential requirements and other relevant provisions of Directive 1999/5/EC.
Estonian	Käesolevaga kinnitab Welch Allyn seadme RLAN device vastavust direktiivi 1999/5/EÜ põhinõuetele ja nimetatud direktiivist tulenevatele teistele asjakohastele sätetele.
Finnish	Welch Allyn vakuuttaa täten että RLAN device tyypinen laite on direktiivin 1999/5/EY oleellisten vaatimusten ja sitä koskevien direktiivin muiden ehtojen mukainen.
French	Par la présente, Welch Allyn déclare que ce RLAN device est conforme aux exigences essentielles et aux autres dispositions de la directive 1999/5/CE qui lui sont applicables
German	Hiermit erklärt Welch Allyn die Übereinstimmung des Gerätes RLAN device mit den grundlegenden Anforderungen und den anderen relevanten Festlegungen der Richtlinie 1999/5/EG. (Wien)
Greek	ΜΕ ΤΗΝ ΠΑΡΟΥΣΑ Welch Allyn ΔΗΛΩΝΕΙ ΟΤΙ RLAN device ΣΥΜΜΟΡΦΩΝΕΤΑΙ ΠΡΟΣ ΤΙΣ ΟΥΣΙΩΔΕΙΣ ΑΠΑΙΤΗΣΕΙΣ ΚΑΙ ΤΙΣ ΛΟΙΠΕΣ ΣΧΕΤΙΚΕΣ ΔΙΑΤΑΞΕΙΣ ΤΗΣ ΟΔΗΓΙΑΣ 1999/5/EK
Hungarian	Alulírott, Welch Allyn nyilatkozom, hogy a RLAN device megfelel a vonatkozó alapvető követelményeknek és az 1999/5/EC irányelv egyéb előírásainak.

Italian	Con la presente Welch Allyn dichiara che questo RLAN device è conforme ai requisiti essenziali ed alle altre disposizioni pertinenti stabilite dalla direttiva 1999/5/CE.
Latvian	Ar šo Welch Allyn deklarē, ka RLAN device atbilst Direktīvas 1999/5/EK būtiskajām prasībām un citiem ar to saistītajiem noteikumiem.
Lithuanian	Šiuo Welch Allyn deklaruoja, kad šis RLAN device atitinka esminius reikalavimus ir kitas 1999/5/EB Direktyvos nuostatas.
Malti	Hawnhekk, Welch Allyn, jiddikjara li dan RLAN device jikkonforma mal-htigijiet essenzjali u ma provvedimenti oħrajn relevanti li hemm fid-Direttiva 1999/5/EC
Portuguese	Welch Allyn declara que este RLAN device está conforme com os requisitos essenciais e outras disposições da Directiva 1999/5/CE.
Slovak	Welch Allyn týmto vyhlasuje, že RLAN device spĺňa základné požiadavky a všetky príslušné ustanovenia Smernice 1999/5/ES.
Slovene	Šiuo Welch Allyn deklaruoja, kad šis RLAN device atitinka esminius reikalavimus ir kitas 1999/5/EB Direktyvos nuostatas.
Spanish	Por medio de la presente Welch Allyn declara que el RLAN device cumple con los requisitos esenciales y cualesquiera otras disposiciones aplicables o exigibles de la Directiva 1999/5/CE
Swedish	Härmed intygar Welch Allyn att denna RLAN device står i överensstämmelse med de väsentliga egenskapskrav och övriga relevanta bestämmelser som framgår av direktiv 1999/5/EG.

EMC guidance and manufacturer's declarations

EMC compliance

Special precautions concerning electromagnetic compatibility (EMC) must be taken for all medical electrical equipment. This device complies with IEC EN 60601-1-2:2007.

- All medical electrical equipment must be installed and put into service in accordance with the EMC information provided in this *Directions for use*.
- Portable and mobile RF communications equipment can affect the behavior of medical electrical equipment.

The CP150 ELECTROCARDIOGRAPH complies with all applicable and required standards for electromagnetic interference.

- It does not normally affect nearby equipment and devices.
- It is not normally affected by nearby equipment and devices.
- However, it is good practice to avoid using the CP150 ELECTROCARDIOGRAPH in extremely close proximity to other equipment.
- It is not safe to operate the CP150 ELECTROCARDIOGRAPH in the presence of high-frequency surgical equipment.

Emissions and immunity information

Electromagnetic emissions

The CP150 is intended for use in the electromagnetic environment specified below. The customer or user of the CP150 should assure that it is used in such an environment.

Emissions test	Compliance	Electromagnetic environment - guidance
RF emissions CISPR 11	Group 1	The CP150 uses RF energy only for its internal function. Therefore, its RF emissions are very low and are not likely to cause any interference in nearby electronic equipment.
RF emissions CISPR 11	Class A	The CP150 is suitable for use in all establishments, including domestic establishments and those directly connected to the public low voltage power supply network that supplies buildings used for domestic purposes.
Harmonic emissions IEC 61000-3-2	Class A	 WARNING This equipment/system is intended for use by healthcare professionals only. This equipment/ system may cause radio interference or may disrupt the operation of nearby equipment ^a . It may be necessary to take mitigation measures, such as re-orienting or relocating the CP150 or shielding the location.
Voltage fluctuations/ flicker emissions IEC 61000-3-3	Complies	

^a The CP150 contains a 5-GHz orthogonal frequency-division multiplexing transmitter or a 2.4-GHz frequency hopping spread-spectrum transmitter for the purpose of wireless communication. The radio is operated according to the requirements of various agencies, including FCC 47 CFR 15.247 and R&TTE Directive (1995/5/EC). The transmitter is excluded from the EMC requirements of 60601-1-2, but should be considered when addressing possible interference issues between this and other devices.

Electromagnetic immunity

The CP150 is intended for use in the electromagnetic environment specified below. The customer or the user of the CP150 should assure that it is used in such an environment.

Immunity test	IEC 60601 test level	Compliance level	Electromagnetic environment - guidance
Electrostatic discharge (ESD) IEC 61000-4-2	±6 kV contact ± 8 kV air	± 6 kV contact ± 8 kV air	Floors should be wood, concrete or ceramic tile. If floors are covered with synthetic material, the relative humidity should be at least 30%.
Electrical fast transient/burst IEC 61000-4-4	±2 kV for power supply lines ±1 kV for input/output lines	±2 kV for power supply lines ±1 kV for input/output lines	Mains power quality should be that of a typical commercial or hospital environment.
Surge IEC 61000-4-5	± 1 kV differential mode ± 2 kV common mode	± 1 kV differential mode ± 2 kV common mode	Mains power quality should be that of a typical commercial or hospital environment.
Voltage dips, short interruptions and voltage variations on power supply input lines IEC 61000-4-11	>95% dip in 0.5 cycle 60% dip in 5 cycles 30% dip for 25 cycles >95% dip in 5 seconds	>95% dip in 0.5 cycle 60% dip in 5 cycles 30% dip for 25 cycles >95% dip in 5 seconds	Mains power quality should be that of a typical commercial or hospital environment. If the user of the CP150 requires continued operation during power mains interruptions, it is recommended that the CP150 be powered from an uninterruptible power supply or a battery.

Electromagnetic immunity

The CP150 is intended for use in the electromagnetic environment specified below. The customer or the user of the CP150 should assure that it is used in such an environment.

Immunity test	IEC 60601 test level	Compliance level	Electromagnetic environment - guidance
			Portable and mobile RF communications equipment should be used no closer to any part of the CP150, including cables, than the recommended separation distance calculated from the equation applicable to the frequency of the transmitter.
Recommended separation distance			
Conducted RF IEC 61000-4-6	3 Vrms 150 kHz to 80 MHz	3 Vrms	$d = (1.17) \sqrt{P}$
Radiated RF IEC 61000-4-3	3 V/m 80 MHz to 2.5 GHz	3 V/m 80 MHz to 2.5 GHz	$d = (1.17) \sqrt{P}$ 80 to 800 MHz

$$d = (2.33) \sqrt{P} \text{ 800 MHz to 2,5 GHz}$$

where P is the maximum output power rating of the transmitter in watts (W) and d is the recommended separation distance in meters (m). Field strengths from fixed RF transmitters, as determined by an electromagnetic site survey^a, should be less than the compliance level in each frequency range^b. Interference may occur in the vicinity of equipment marked with the following symbol:



Note1: At 80 MHz and 800 MHz, the higher frequency range applies.

Note 2: These guidelines may not apply in all situations. Electromagnetic propagation is affected by absorption and reflection from structures, objects, and people.

^aField strengths from fixed transmitters, such as base stations for radio (cellular/cordless) telephones and land mobile radios, amateur radio, AM and FM radio broadcast, and TV broadcast cannot be predicted theoretically with accuracy. To assess the electromagnetic environment due to fixed RF transmitters, an electromagnetic site survey should be considered. If the measured field strength in the location in which the CP150 is used exceeds the applicable RF compliance level above, the CP150 should be observed to verify normal operation. If abnormal performance is observed, additional measures may be necessary, such as reorienting or relocating the CP150.

^bOver the frequency range 150 kHz to 80 MHz, field strengths should be less than 3 V/m.

Recommended separation distances between portable and mobile RF communications equipment and the CP150

The CP150 is intended for use in an electromagnetic environment in which radiated RF disturbances are controlled. The customer or user of the CP150 can help prevent electromagnetic interference by maintaining a minimum distance between portable and mobile RF communications equipment (transmitters) and the CP150 as recommended below, according to the maximum output power of the communications equipment.

Recommended separation distances between portable and mobile RF communications equipment and the CP150

Separation distance according to frequency of transmitter (m)			
Rated max. output power of transmitter (W)	150 kHz to 80 MHz $d = (1.17) \sqrt{P}$	80 MHz to 800 MHz $d = (1.17) \sqrt{P}$	800 MHz to 2.5 GHz $d = (2.33) \sqrt{P}$
0.01	0.11667	0.11667	0.23333
0.1	0.36894	0.36894	0.73785
1	1.1667	1.1667	2.3333
10	3.6894	3.6894	7.3785
100	11.667	11.667	23.3333

For transmitters rated at a maximum output power not listed above, the recommended separation distance d in meters (m) can be estimated using the equation applicable to the frequency of the transmitter, where P is the maximum output power rating of the transmitter in watts (W) according to the transmitter manufacturer.

Note 1: At 80 MHz and 800 MHz, the separation distance for the higher frequency range applies.

Note 2: These guidelines may not apply in all situations. Electromagnetic propagation is affected by absorption and reflection from structures, objects, and people.

Specifications

Item	Specification
Dimensions, including rubber feet (length x width x height)	380.9 mm x 358.1 mm x 136.2 mm (15 x 14.1 x 5.4 in.)
Weight , including battery	5.3 kg (11.7 lb)
Keyboard type (power button)	Polyester overlay
Display	
Type	TFT, 18 cm (7 in.) color touch screen
Resolution	WVGA, 800 x480
Thermal paper	
Z-fold	8.25 x 11 inches (21 x 28 cm), 200 sheets
Thermal printer (internal)	Computer-controlled dot array, 8 dots/mm
Thermal-chart-paper speeds	10, 25, 50 mm/s
Gain settings	
Auto ECGs	2.5, 5, 10, 20 mm/mV, Auto
Rhythm ECGs	2.5, 5, 10, 20 mm/mV
Lead configurations	Standard, Cabrera
Report formats, internal printer, Auto report*	3x4-2.5s @ 25 mm/s 3x4-2.5s @ 50 mm/s 3x4+1R-2.5s @ 25 mm/s 3x4+3R-2.5s @ 25 mm/s 3x4-5.0s @ 25 mm/s 3x4-5.0s @ 50 mm/s

Item	Specification
	6x2-5.0s @ 25 mm/s 6x2-5.0s @ 50 mm/s 12x1-10.0s @ 25 mm/s
Report formats, internal printer, Average	3x4+3R @ 25 mm/s 3x4+3R @ 50 mm/s 6x2+1R @ 25 mm/s 6x2+1R @ 50 mm/s No print
ECG storage (in test directory)	At least 100 ECG tests
Patient storage	Up to 50 patients
Frequency range	0.3 to 150 Hz
Digital sampling rate	> 1,000 samples/second/channel
Pacemaker detection	ANSI/AAMI EC11
Power requirement	Universal AC power supply 110-240 V~, 50/60 Hz ~, 1.5 A maximum
AC fuses	Time-lag type, 2.0-amp 250-V rating, Littelfuse 0218002P or equivalent
Rechargeable battery	9 cells
Rating	10.8 V 6.75Ah (73Wh)
Composition	Lithium-ion
Recharge time to 90 percent capacity	4 hrs
Full charge capacity	25 ECG tests @ 20 minutes per test
	8 hrs of continuous operation or 250 continuous ECGs
Filters	
High-performance baseline	0.5 Hz
Muscle tremor	35 Hz
AC interference	50 Hz or 60 Hz
Standard connectivity	1 USB client 4 USB hosts WiFi

Item	Specification
	Ethernet
Connectivity with electronic medical records	DICOM tests submitted through wireless connectivity
Electrodes	Rigorously tested for conductivity, adhesion, and hypoallergenic qualities, and exceed all AAMI standards
Power cable	Meets or exceeds Type SJT.
Environmental operating conditions	<p>Temperature +10° C to +40° C (+50° F to +104° F)</p> <p>Relative humidity 15 - 95% noncondensing (30 - 70% for printing)</p> <p>Atmospheric air-pressure limits 700 - 1060 hPa</p>
Environmental storage conditions	<p>Temperature -20° C to +50° C (-4° F to +122° F)</p> <p>Relative humidity 15 - 95% noncondensing</p> <p>Atmospheric air-pressure limits 700 - 1060 hPa</p>
Protection against electric shock	Class I, internally powered Type CF
Mode of operation	Continuous

* If you print at a high gain setting, the waveform or calibration marks might be clipped. This clipping does not comply with clause 51.103.1 of the IEC/EN 60601-2-51 standard. Use a lower gain setting to observe the full waveform.

** Per AAMI EC11:1991/©2007 Diagnostic Electrocardiographic Devices, Section 3.1.2.1 Disclosure of cautionary information/ performance characteristics paragraph c) Accuracy of input signal reproduction, the manufacturer shall disclose the methods used to establish overall system error and frequency response. Welch Allyn has used methods A & D, as prescribed in section 3.2.7.2 and 4.2.7.2 of this same standard, to verify overall system error and frequency response. Because of the sampling characteristics and the asynchronism between sample rate and signal rate, digital ECG systems such as the CP 150 may produce a noticeable modulating effect from one cycle to the next, particularly in pediatric recordings. This phenomenon is not physiologic.

*** Disposable electrodes from Welch Allyn shall be used during patient defibrillation.

Specifications are subject to change without notice.

Appendix

Approved accessories

The following tables list approved electrocardiograph accessories and documentation. For information about options, upgrades, and licenses, refer to the service manual.

Options and software upgrades

Part Number	Description
105410	Interpretation upgrade, CP 150 (unit serial number Is required)
406814	CP 50/150 connectivity kit
105660	CP 150 spirometry upgrade kit
106736	CP 150 DICOM upgrade kit (unit serial number Is required)

Electrodes and ECG chart paper

Part Number	Description
715006	ECG multifunction electrode adaptor
45008-0000	Resting tab electrodes (box of 1000)
714730	ECG reusable suction cup electrodes, 6
714731	ECG reusable limb clamps, IEC, 4
715992	ECG reusable limb clamps, AHA, 4
719653	10-lead ECG patient cable ,AHA , banana (1M/39 inch), CP 150
719654	10-lead ECG patient cable, IEC, banana, CP 150
721328	10-lead ECG patient cable, AHA, banana (1.5M/5 feet), CP 150

Part Number	Description
105353	CP 100/200/150 ECG Chart Paper (200 sheets/pack, 5 packs/case)

ECG Cart

Part Number	Description
105341	CP 150 Office cart (cable arm and shelf sold separately)
105342	CP 150 Hospital cart (cable arm and shelf sold separately)
105343	CP 150 Cable arm and shelf cart option (compatible with the CP 150 office and hospital carts)

Miscellaneous items

Part Number	Description
BATT99	Lithium-ion battery assembly 9-Cell
PWCD-B	Line cord B, North America
PWCD-2	Line cord 2, Europe
PWCD-3	Line cord 3, Israel
PWCD-4	Line cord 4, United Kingdom
PWCD-66	Line cord 66, Australia/New Zealand —Orange
PWCD-C	Line cord C, China
PWCD-7	Line cord 7, South Africa
PWCD-A	Line cord A, Denmark
PWCD-Z	Line cord Z, Brazil
PWCD-5	Line cord 5, Switzerland
701586	Dust cover, CP 100/150/200
719685	#2 Phillips screwdriver for battery door

Literature/Documentation

Part Number	Description
106580	Kit, CD, User documentation CP 150, Multi-lingual
103521	Welch Allyn Service Tool CD

Part Number	Description
719728	Welch Allyn Service Tool Flyer
Quick Reference Guide	
724162	Quick Reference Guide, Printed Copy, English
724166	Quick Reference Guide, Printed Copy, French
724169	Quick Reference Guide, Printed Copy, German
724165	Quick Reference Guide, Printed Copy, Dutch
724167	Quick Reference Guide, Printed Copy, Eur. Portuguese
724171	Quick Reference Guide, Printed Copy, Spanish
724174	Quick Reference Guide, Printed Copy, Simplified Chinese
724175	Quick Reference Guide, Printed Copy, Swedish
724172	Quick Reference Guide, Printed Copy, Norwegian
724173	Quick Reference Guide, Printed Copy, Russian
724163	Quick Reference Guide, Printed Copy, Br. Portuguese
724164	Quick Reference Guide, Printed Copy, Danish
724168	Quick Reference Guide, Printed Copy, Finnish
724170	Quick Reference Guide, Printed Copy, Italian
725134	Quick Reference Guide, Printed Copy, Korean
725235	Quick Reference Guide, Printed Copy, Traditional Chinese
725180	Quick Reference Guide, Printed Copy, Turkish
Startup Guide	
106581	Startup Guide, Printed Copy
