

Delco

ELEVATOR PRODUCTS

STANDARD GOVERNOR

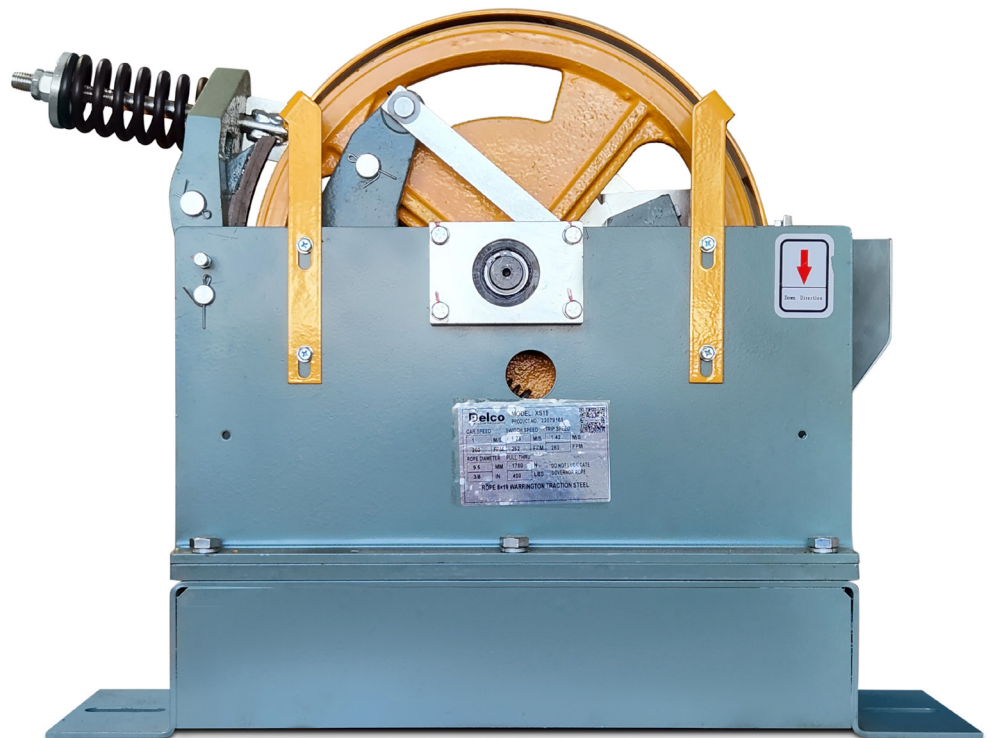

www.delcoelevator.com
info@delcoelevator.com | 1-866-900-3727

CONTENTS

ABOUT DELCO	3
HOW TO ORDER	3
SPECIFICATION	4
General	4
Overspeed Switch Specification	5
WORKING PRINCIPLE	6
Features	8
Governor Data Plate	9
Safety Requirements	10
Safety Cover	10
FIELD REQUIREMENTS.....	11
Equipment Verification	11
INSTALLATION	13
Mounting Location & Alignment	13
Fastening To Building Structures	15
Electrical Connection	15
GOVERNOR RESET	16
TESTING	17
General Inspection	17
Operational Testing	18
MAINTENANCE	19
Lubrication	20

ABOUT DELCO

In Stock, Non-Proprietary, Proven & Competitive

Delco Elevator Products Ltd. has always been a family owned and operated business and is proud to have been helping our customers with elevator components for over 45 years.

With a head office and warehouse in Vancouver, BC, Canada, and a warehouse in Ferndale, WA, USA, Delco is strategically located to source, stock and ship elevator products to customers in Canada, the Caribbean and the US.

From Torin machines to popular components, including roller guides, shackles, oil buffers, governors and door edges to a range of elevator parts, the company's comprehensive product selection is one of the reasons that customers have been returning to Delco for decades.

Another reason is that we are very good at ensuring that the right items arrive at the right time to elevator contractors across North America.



Delco's dedicated, experienced and enthusiastic team works diligently to provide exceptional service in the following key areas:

- **In Stock:** We keep our inventory stocked to make sure that customers receive what they need, when they need it.
- **Non-Proprietary:** Delco's products are universal – perfect for modernizations.
- **Proven Products:** Delco manufactures and distributes products that are tried, tested and proven in the field.
- **Compliant:** Delco products and equipment meet all elevator industry compliance and certification standards.
- **Value for Money:** In a highly competitive marketplace, Delco provides the best quality elevator equipment at the lowest possible prices.
- **Personal, Knowledgeable Staff and Service:** Always on hand to assist you with your unique requirements!

HOW TO ORDER

Delco services elevator contractors and OEMs in Canada, the Caribbean and the US, including Puerto Rico and Hawaii.

We'd love to hear from you and give you a quote on your next project. **Call, email or visit us today!**

OFFICE & WAREHOUSE CANADA
#205-3765 1st Avenue
Burnaby, BC V5C 3V8

WAREHOUSE USA
1465 Slater Rd,
Ferndale, WA 98248

Phone: 1.604.904.3727 - CAN/USA
Phone: 1.908.692.5134 - NY/NJ/CT
Toll Free: 1.866.900.3727
Email: info@delcoelevator.com
www.delcoelevator.com

We look forward to welcoming you to our family of customers and friends.

SPECIFICATION

The main function of Delco Standard Overspeed Governor XS19 is to detect the increase of the elevator car speed over a code prescribed limit and initiate the trigger for the safe stopping of the elevator car.

This governor is designed and built to meet both CSA B44 and ASME A17.1 code specifications.



General Specification

Car rated speed range	0.50-2.54 m/s	100-500 FPM
Maximum Mechanical Tripping Speed	Conforms to requirements in table 2.18.2.1 CSA-B44/ANSI 17.1 (See appendix 1)	
Maximum Car speed at which Governor Overspeed switch operates down	Conforms to requirements in table 2.18.2.1 CSA-B44/ANSI 17.1 (See appendix 1)	
Governor hand	Left or right	
Sheave Pitch Diameter	305 mm	12 inches
Rope Diameter	9.5 mm or 10 mm	3/8 inch or 10 mm
Rope Type	Traction Steel 8 X 19	
Pull Through (set value no range)	1780 N	400 Lbf
Over Speed Switch	YES	
Live encoder shaft diameter	20 mm OD with 8 mm bore	0.789 inch OD with 0.314 inch bore
Protective cover	YES	
Shipping weight	47 kg	105 Lb

Overspeed Switch Specification

Switch part number	DEL-S3-1375
Manufacture	Shanghai Huasheng Electric Co.
Contact type	2NC- normal closed spring loaded
Frequency	50/60 Hz
Rating	110 Vdc-3 A ; 220 Vac- 5 A, 380 Vac- 4 A
Ambient Temperature	-25 °C to +70 °C
Relative Humidity	<90%
IP Rating	IP54

Running Speed		Max Overspeed Switch Setting		Max Mechanical Tripping Speed	
FPM	M/S	FPM	M/S	FPM	M/S
0-125	0-0.64	158	0.80	175	0.89
150	0.76	189	0.96	210	1.06
200	1.02	252	1.28	280	1.42
250	1.27	303	1.54	337	1.71
300	1.52	353	1.79	395	2.01
350	1.77	407	2.07	452	2.30
400	2.03	459	2.33	510	2.59
500	2.54	563	2.86	625	3.18

Appendix 1

This governor should only be used in application with the maximum specified speed on the data tag. This type of governor is designed for indoor applications only.

WORKING PRINCIPLE

- Delco Standard Overspeed Governor XS19 is a centrifugal type with a horizontal shaft. The simple construction provides a short response time, reliability in operation and minimal space requirement for installation.
- This governor has two pivoting flyweights connected with a solid link to ensure simultaneous movement (*see figure 1*). The movement of the flyweights is controlled with a helical spring system (*see figure 2*). As the governor pulley rotates in the vertical plane, driven by the governor rope movement, the flyweights are driven outward due to the centrifugal force and compressing the calibrated spring assembly.
- In the down direction, when the governor pulley rotation exceeds the rated speed, by a set value, the outward movement of the flyweights will trip an overspeed switch that will send an electrical signal to the elevator control system to initiate an emergency shut down.
- If the elevator continues to move and the speed continues to increase, the furthered outward movement of the flyweights will cause the pawl to engage the ratchet and thru the spring loaded shoe linkage will engage the governor shoe on to the governor rope to stop it (*see figure 3*).
- The increase in the governor rope tension will actuate the car safety assemblies, which will clamp on to the guide rails and mechanically stop the elevator. The governor latch will lock on the pin and the shoe will be locked against the sheave (*see figure 4*).

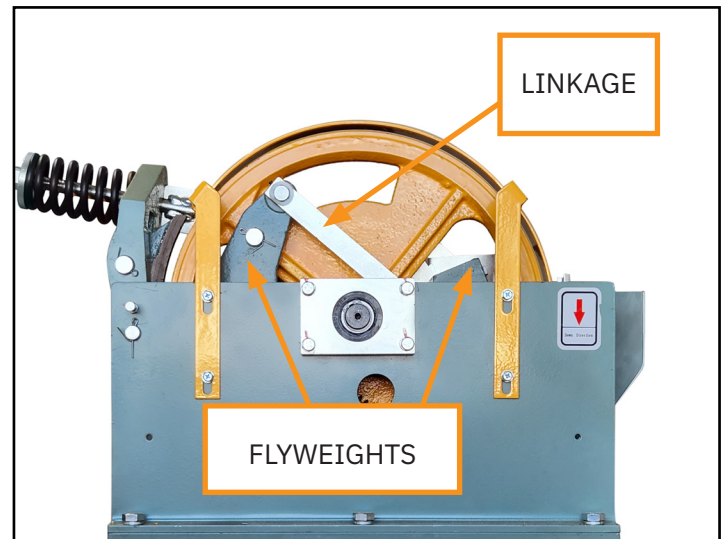

Figure 1

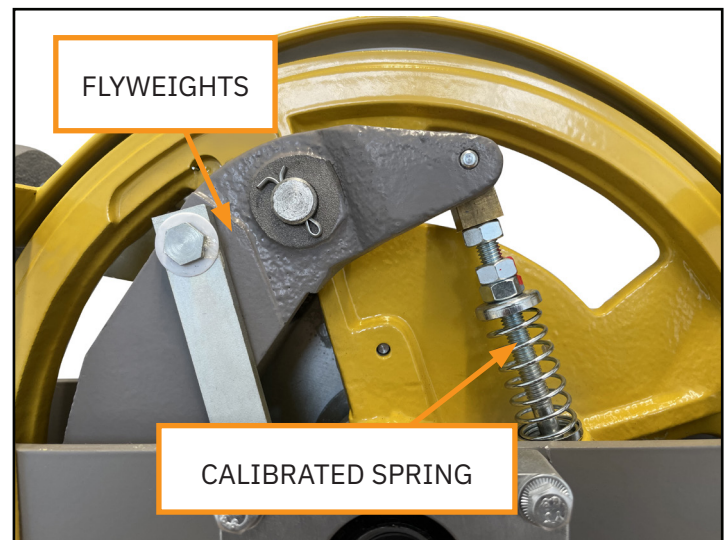

Figure 2

STANDARD GOVERNOR

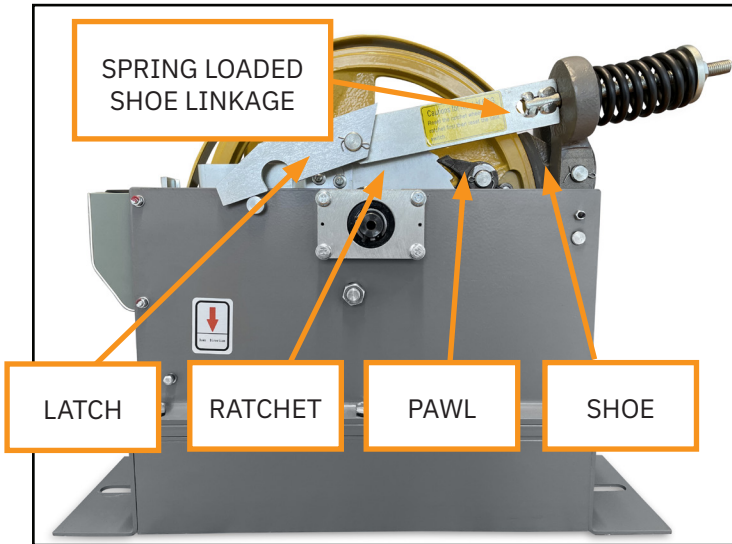

Figure 3

- In the up direction, when the governor pulley rotation exceeds the rated speed, by a set value, the outward movement of the flyweights will trip an overspeed switch that will send an electrical signal to the elevator control system to initiate an emergency shut down.
- If the speed continues to increase in the up direction, the governor will not engage the car safety assembly. In this instance a different ascending protection method is required to stop the unintended motion.

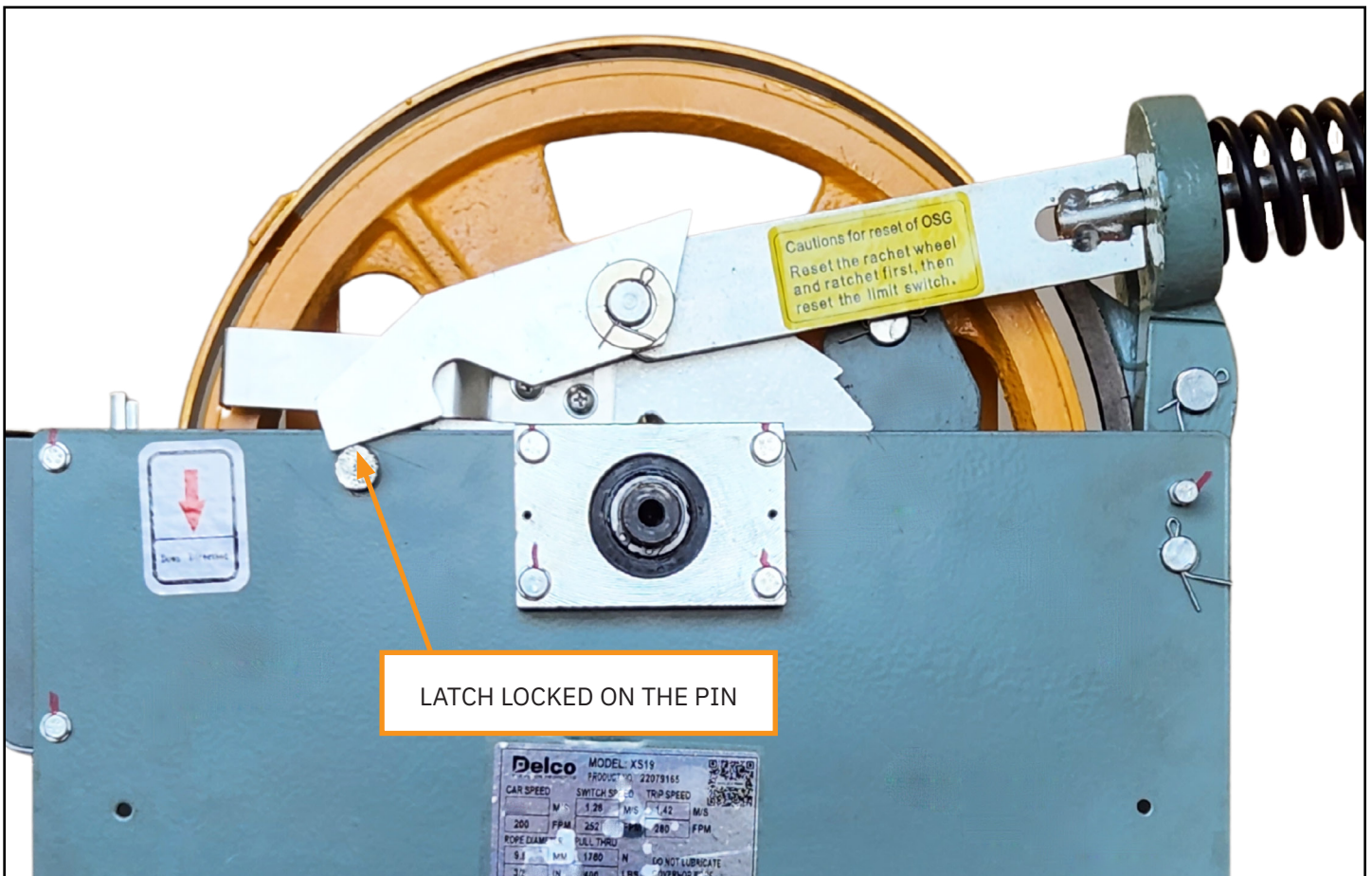

Figure 4

Features

The XS-19 Delco Governor is supplied with a kit that includes 2 encoder brackets, one encoder cover and hardware to secure the brackets and the encoder (see figure 1). This kit will allow the installation of few different types of encoders to the shaft of the governor sheave.

The encoder shaft has to be adapted to mate with the existing 8 mm hole in the governor sheave shaft. For hollow shaft type encoders, few types of encoder shafts adaptors (see figure 5) are available, as separate items for purchase, from Delco.

The encoder brackets provided are with a 2 or 3 holes pattern for the encoder attachment. Select the bracket matching the encoder mounting holes pattern. Use the M3 x 8mm screws for the 25T type encoders and the M3 x 40 mm for the IH740 type encoder.

The bearing support plate has two M3 tapped holes that can be used to secure the encoder bracket. Use two M3 x 12 screws, M3 plain washer and M3 split washer, provided in the kit, to connect the encoder bracket to the bearing support of the governor. (see figure 2)

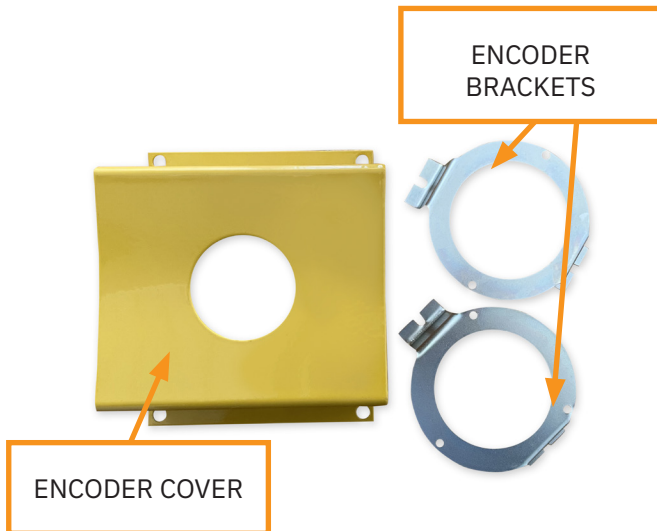

Figure 1

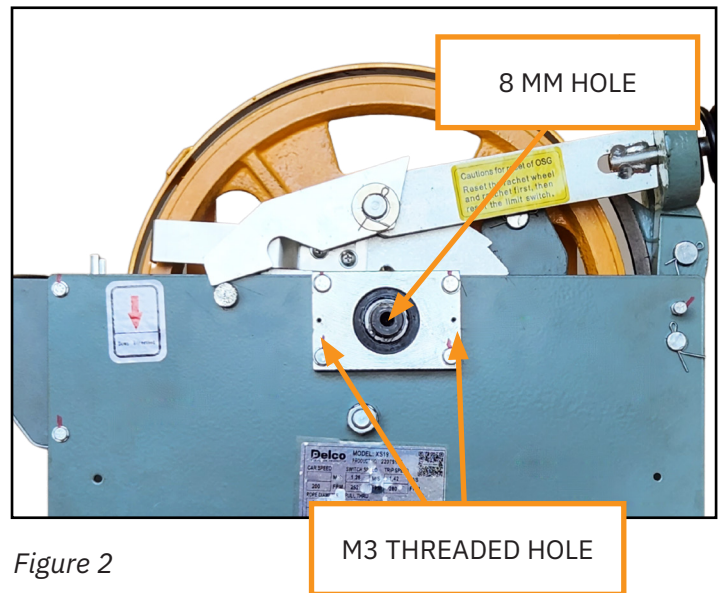

Figure 2

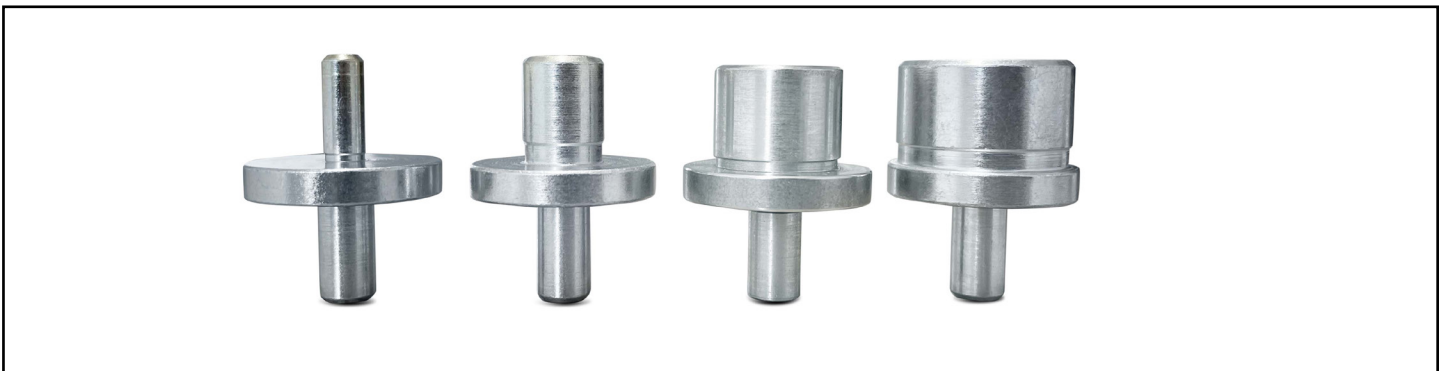

Figure 5

Figure 3 shows example of encoder bracket installation

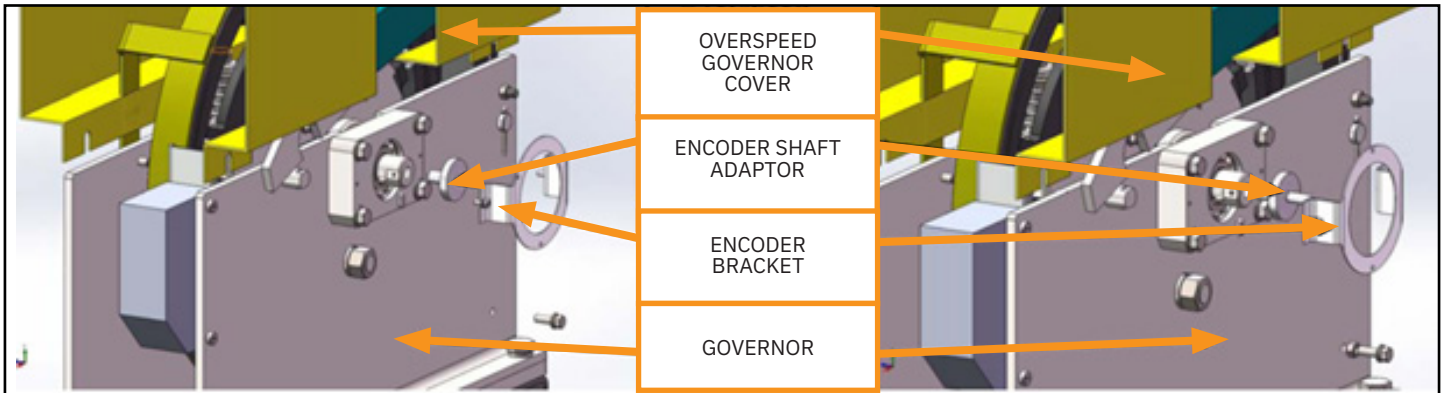

Figure 3

After the encoder has been attached install the encoder protective cover using four M5 x 12 screws and M5 nuts, washer and split washer provided in the kit (see figure 4)

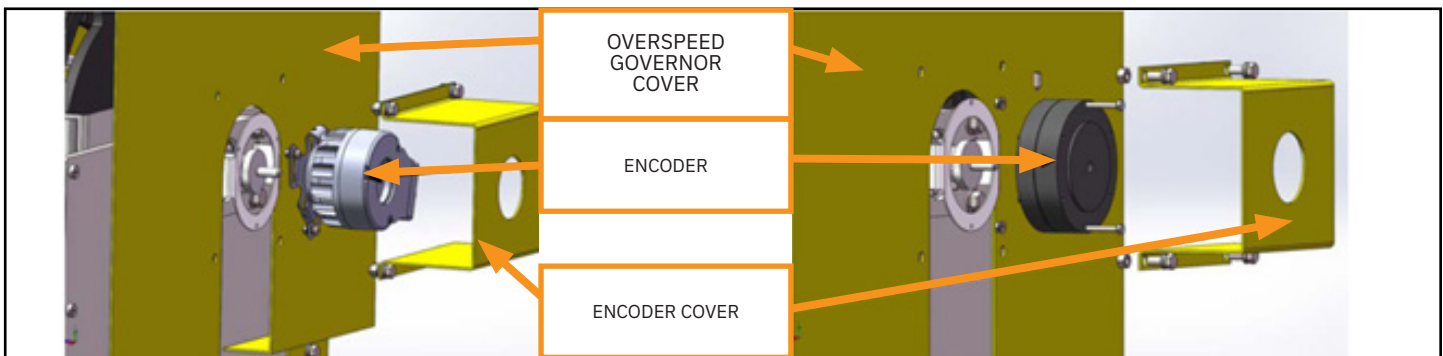

Figure 4

Governor Data Plate

		MODEL: XS19	
		PRODUCT NO. xxxxxxxx	
CAR SPEED	SWITCH SPEED	TRIP SPEED	
1.75 M/S	2.117 M/S	2.210	M/S
350 FPM	417 FPM	435	FPM
ROPE DIAMETER	PULL THRU	DO NOT LUBRICATE GOVERNOR ROPE	
10 MM	1800 N		
3/8 IN	400 LBS		
ROPE 8x19 WARRINGTON TRACTION STEEL			

Every governor comes with two name plates attached on both sides of the governor.

Safety Requirements

1. Installation of the governor should be done by qualified and certified personnel.
2. Adequate personal protective equipment must be worn for the installation.
3. Tools and equipment used for the installation must be inspected and in good condition for the work.
4. National and local, governing elevator safety requirements must be followed.
5. Read and understand the product installation instructions, provided with the unit, before proceeding.
6. For the safe operation of the governor, the governor rope must be kept dry all the time.

***Lubrication of the rope is **not permitted**

Safety Cover

- The XS19 governor is provided with as a standard option with a protective cover.
- The cover is secured to the governor housing with 4 X M5 hex head screws, flat washer and split washer. To remove the cover just loosen the 4 screws.
- For the option with encoder, a separate encoder protective cover is provided in the encoder adaptor kit.
- To secure the cover to the governor, tighten the four screws until split washer is fully compressed.

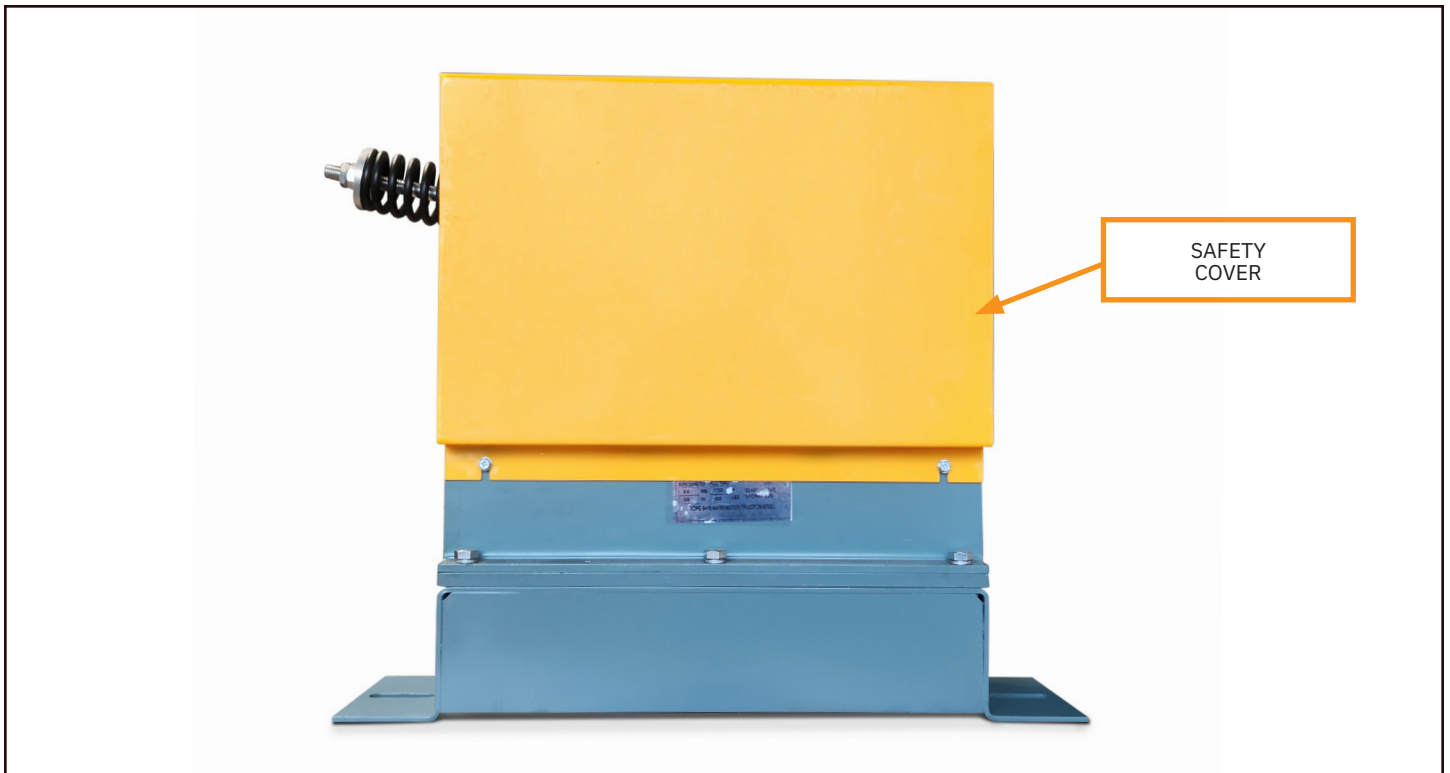

FIELD REQUIREMENTS

Equipment Verification

Before installation in the field verify that all the governor components are present. Review the following details and features:

1. Check the governor data plate information to ensure that the governor is designed for the intended speed range and pull-through force in filed application.
2. Check and ensure that all the Paint Seals are intact (*see figures 1,2&3*). Governor is calibrated and sealed from the factory and if any of the seals are tampered with or missing, do not use the unit. In this instance, unit has to be checked for calibration.
3. Lift manually the pawl, fly weights to ensure that are moving freely. Check visually all linkages, pins, bearings to ensure that are functional and there is no visible damage to the unit.

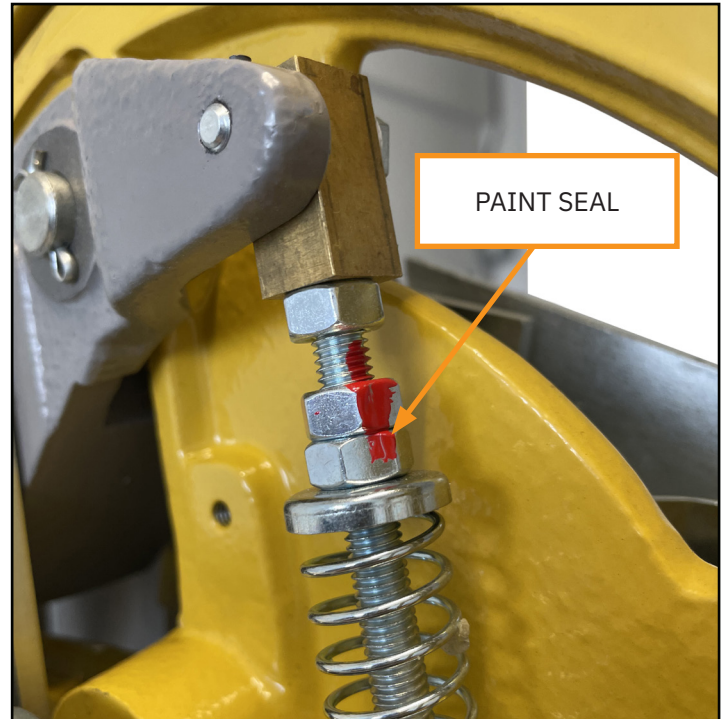

Figure 1

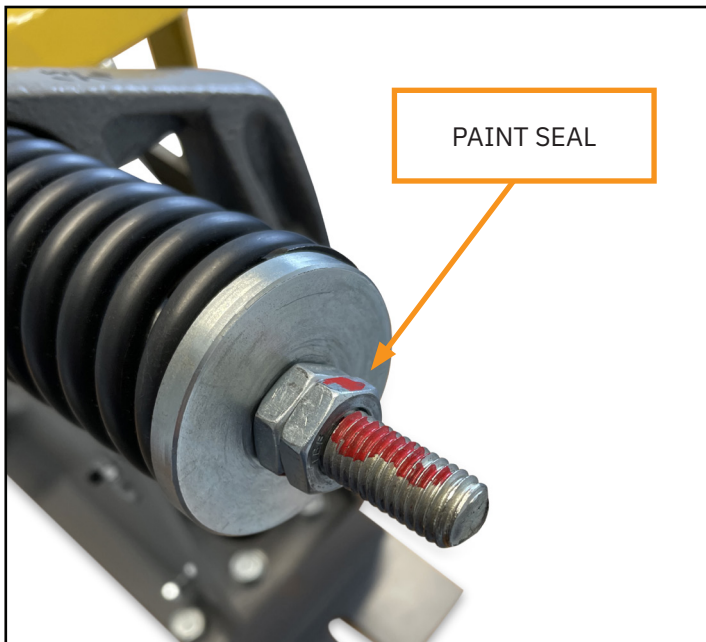

Figure 2

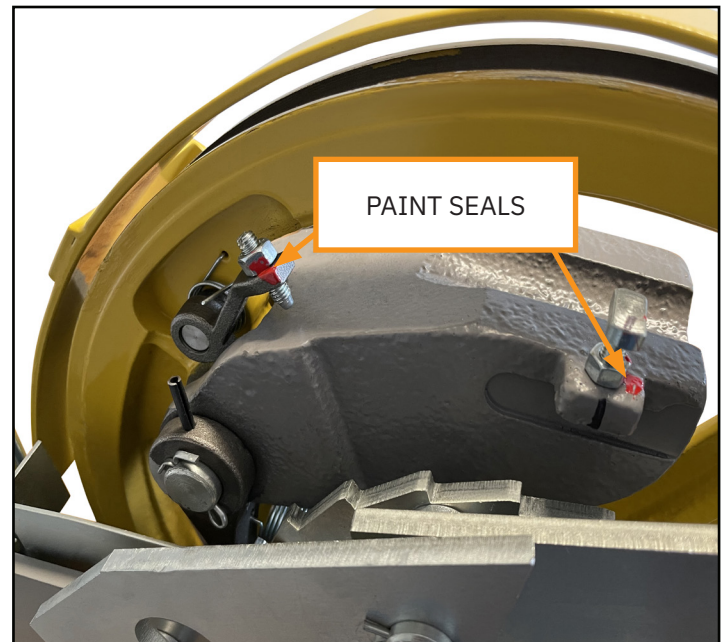

Figure 3

4. Check the governor hand to ensure the correct type for the application (see figure 4). When determining the hand of the governor the side with the red arrow label should be facing towards the center of car. The red arrow on the unit indicates side for the cable drop to the car safeties and the rope traveling direction when the car is moving in the “DOWN” direction. Due to almost symmetrical construction of the governor along the longitudinal axis, the governor can be used for the other hand too. In this case the governor side with the label will be facing towards the elevator shaft wall, the red arrow still must be aligned with cable drop to the car safety and to point the same direction as the governor rope moving direction when the car in moving in the “DOWN” direction. This option should be considered only when sufficient space is available around the governor for access.
5. Check to ensure that 8.0 or 9.5 mm (5/16 or 3/8”) rope is used on this application.
6. Ensure control signals from the elevator controller are available for overspeed switch.

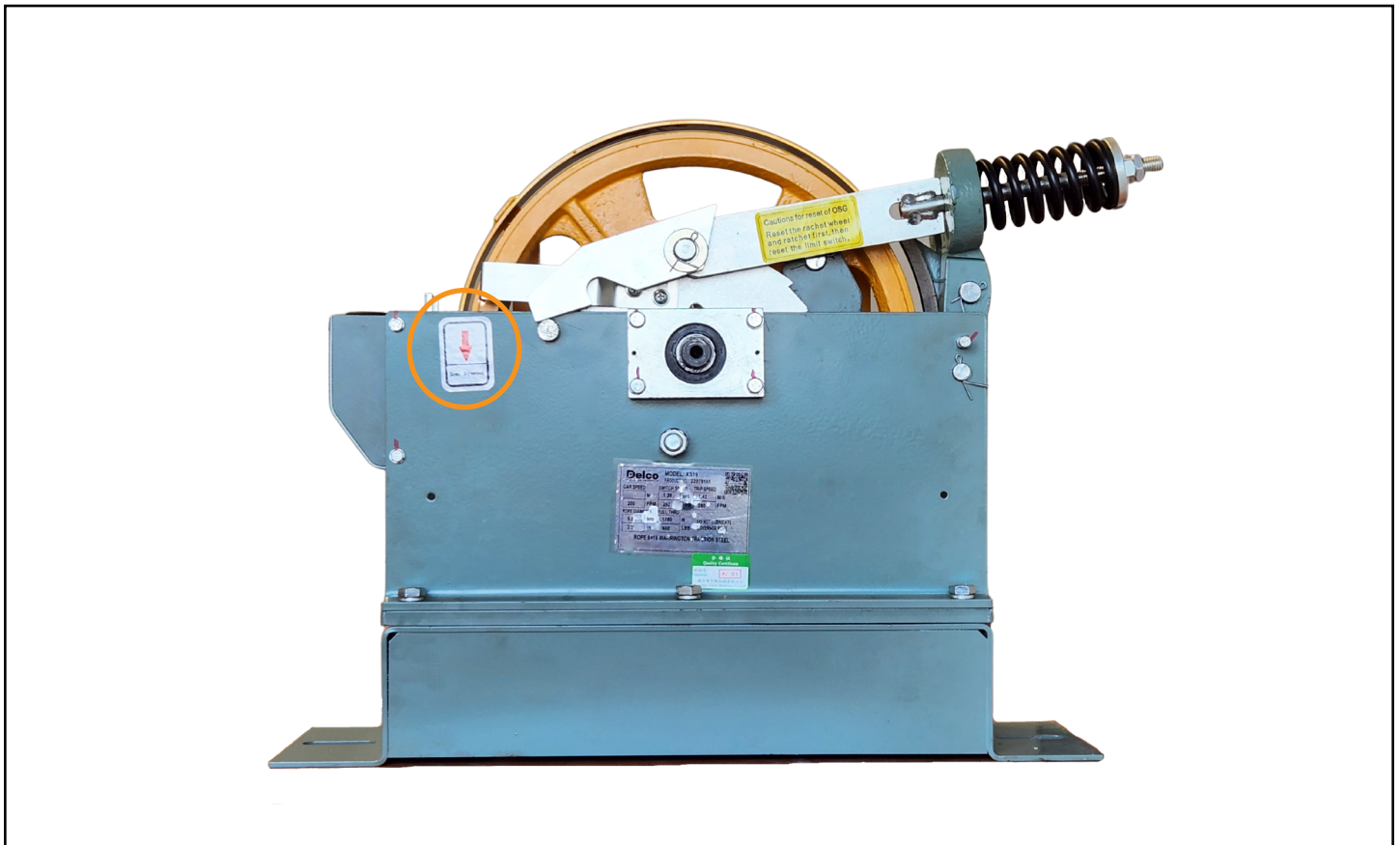

Figure 4

INSTALLATION

Mounting Location & Alignment

- Determine the governor cable drop locations (match existing layout or use applicable job layout plans).
- Orient governor with the red arrow close to the guide rail and align sheave with the governor rope drops. Make sure the cable drop on the car side rope attachment is a straight drop from the sheave. Notice the governor shoe will be opposite to the car side rope attachment.
- Verify that adequate clearance exists around the governor for operating without interference with other elevator equipment or support surface.
- Use a plumb line from the governor sheave to align the idler sheave of the rope tensioner assembly in the elevator pit.
- Ensure routing of the electrical wire and conduit for the overspeed switch will not interfere with the governor operation or ease of removal.

This overspeed governor has two possible mounting options:

1. **Governor with the raised base.** Use the two 15mm x 50 mm (9/16" x 2") slots as holes pattern to mark the locations for the mounting hardware on the machine room floor or supporting surface.
2. **Governor without the raised base.** Use the four 14mm (17/32") diameter holes for securing the governor to the support structure. (*see figure 1*)

If the governor is used in a retrofit project, it is possible that the existing mounting pattern will not align with the mounting holes pattern in the governor base, in this case a custom adaptor needs to be designed.

STANDARD GOVERNOR

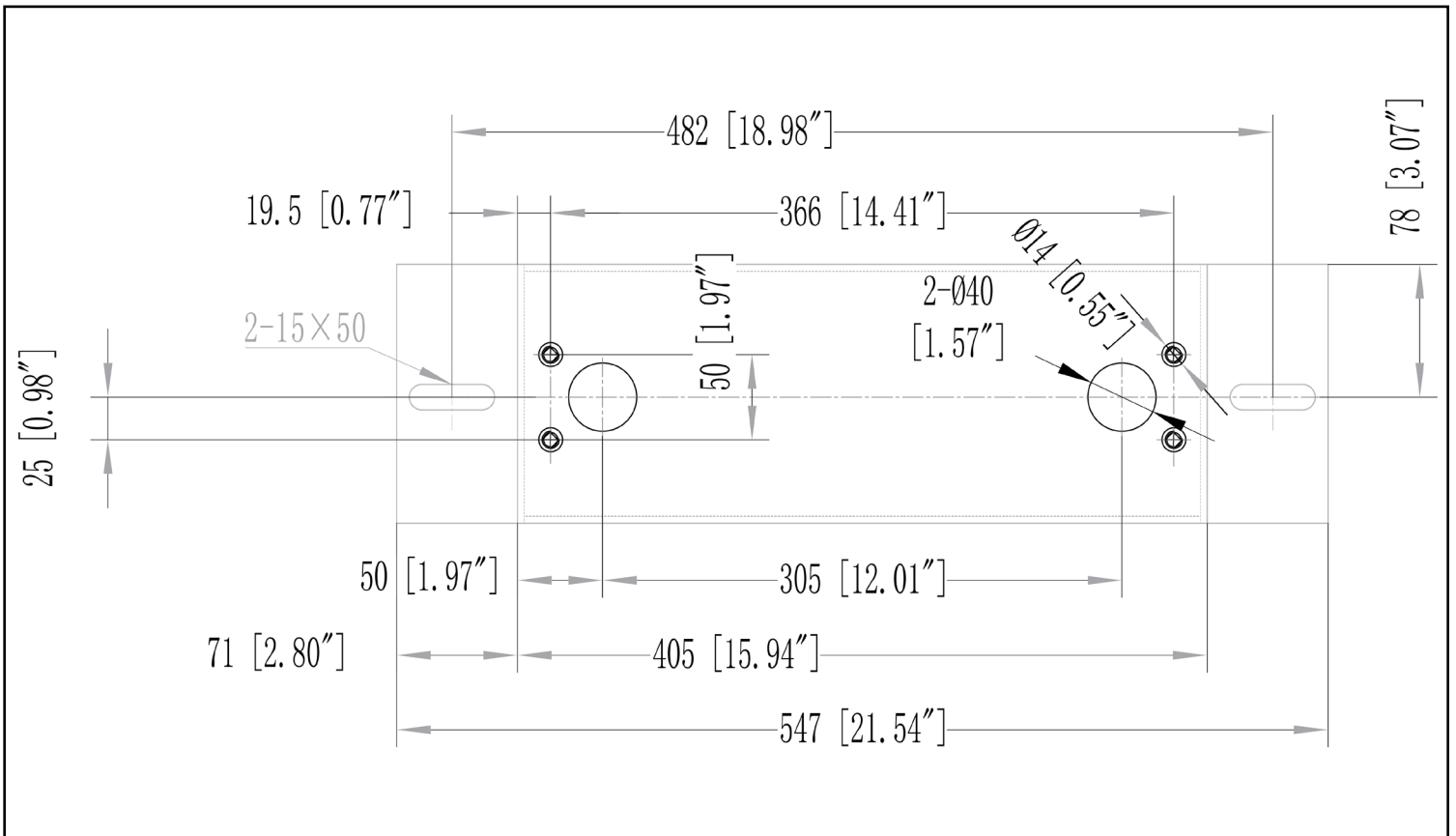

Figure 1

Fastening To Building Structures

- After mounting holes location has been determined, drill holes in the marked locations.
- Customer is responsible for selecting the adequate size of the hardware to secure the governor in place.

Minimum recommended grades for hardware as follows:

- Certified zinc plated anchor bolts and ASME B18.2.2 (or better) zinc plated nuts for installation in concrete floors.
- ASME B18.2.1 (or better) zinc plated bolts and ASME B18.2.2 (or better) zinc plated nuts for installation on metal support structures.

Electrical Connection

- The Delco governor CSA approved overspeed switch, is factory installed in the governor. It has to be connected using CSA approved anti-shorts and insulated eyelet crimp on connectors (see figure 1).
- The flexible metal conduit is to be terminated in a CSA or UL approved junction box (not included) mounted adjacent to the governor.
- The ground wire is to be connected and secured in the junction box and to the grounding stud provided in the governor the switch enclosure.
- CSA or UL approved ground wire and hook up wires must be connected to the controller through the flexible metal conduit or electrical metallic tubing (EMT) to meet local electrical codes.



Figure 1

GOVERNOR RESET

After the elevator has experienced an overspeed condition in which the governor has tripped and set off the safety devices, it will be necessary to reset the governor after the elevator has been deemed safe for operation.

To reset the governor follow this sequence:

- With the elevator in “Inspect” mode move the car in the “UP” direction slowly until the safeties released the rails.
- After the safeties have released, move the car in the “UP” direction slightly, until the pawl to disengage from ratchet (*see figure 1*), and stop the car. Press on the pawls pin, to move the pawl away from the ratchet, until a click sound is heard. At this point the pawl is secured in the up position above the ratchet and has been reset.
- Using a pry bar, lift the latch of the pin to release the shoe.

Very Important: while performing this operation, the mechanic should be aware of the stored energy in the compressed spring and the potential risk for injury. Take necessary precautions to avoid injuries.

- Reset the overspeed switch by moving manually the trip arm to horizontal position (*see figure 2*).

At this point the governor has been mechanically and electrically reset.

Always release the pawl from the ratchet first, before resetting the overspeed switch.

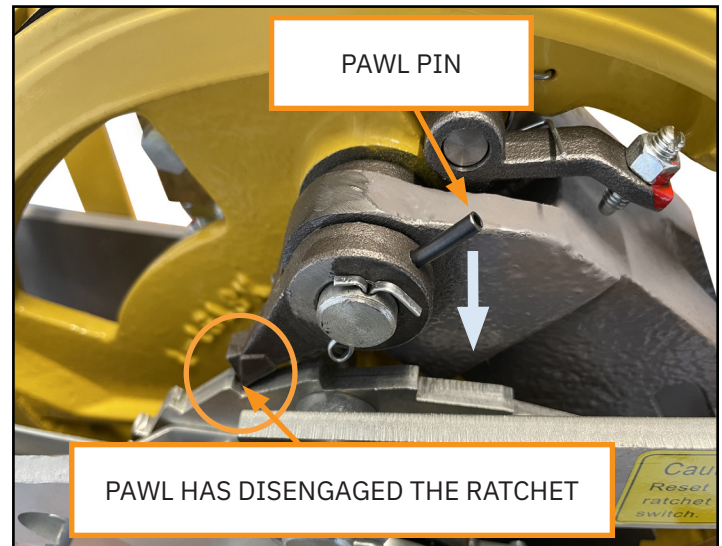

Figure 1

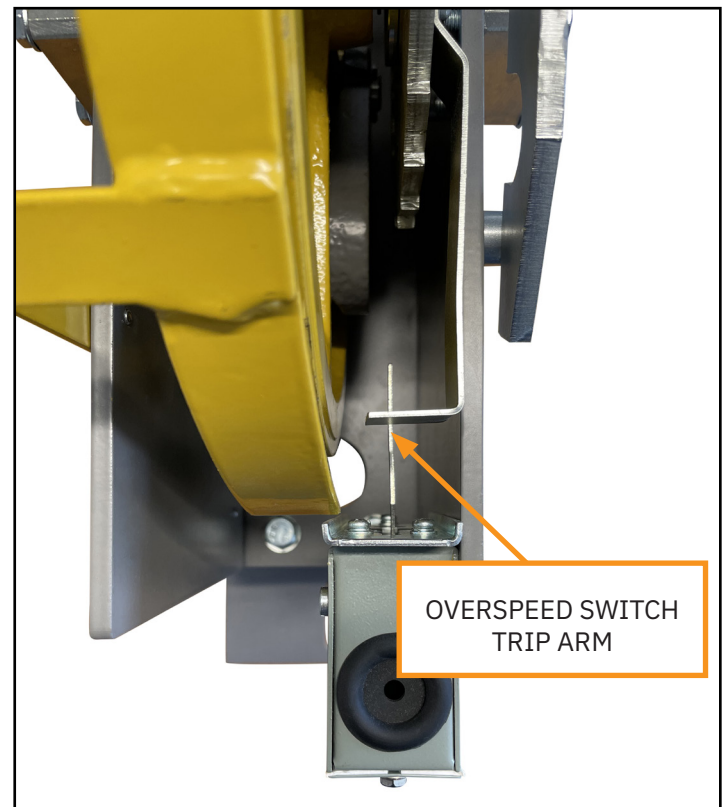
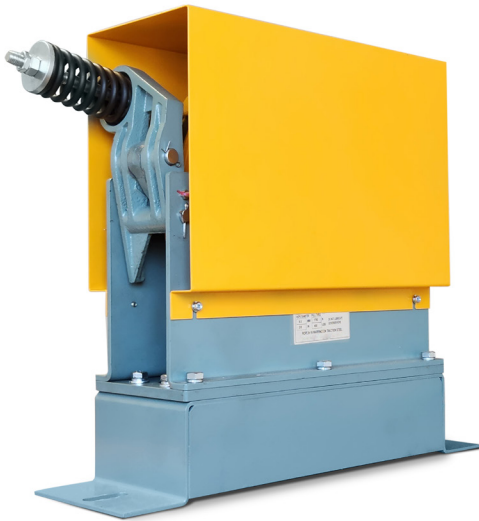

Figure 2

TESTING

General Bench Inspection

- Ensure governor is securely fastened in place to the bench or work surface.
- Examine all linkages, pins, shafts, bearings, bushings and connecting the flyweights to the sheave and the rope gripping device.
- Manually move the flyweights, pawl and the sheave to ensure they are moving and operate freely.
- Check that there is enough room for the rotation of the fly weights in their extreme extended position.
- Inspect rope gripping surfaces (sheave groove and shoe groove) to ensure that are free of obstruction or any foreign substances (paint, grease etc).
- The governor is provided with an overspeed switch, move manually the trip arm of the switch from the horizontal position to a vertical position to ensure it operates freely.



Operational Testing

“UP” Direction electrical tripping

- Check the sheave is rotating freely.
- Check the trip arm of overspeed switch is in horizontal position.
- With a rubber drive wheel held against the governor sheave outside face (*see figure 1*), slowly and gradually accelerate the governor sheave to rotate in the opposite direction indicated by the red arrow on the housing, until it trips the electrical switch (the trip arm is not horizontal and the electrical contact is open). At this point the testing will be stopped since in the “UP” direction the mechanical tripping is not operational.

“DOWN” Direction electrical & mechanical tripping

- Check the sheave is rotating freely.
- Check the trip arm of overspeed switch is in horizontal position.
- With a rubber drive wheel held against the governor sheave outside face (*see figure 1*), slowly and gradually accelerate the governor sheave to rotate in the direction indicated by the red arrow on the housing, until it trips the electrical switch (the trip arm is not horizontal and the electrical contact is open).
- Continue to engage the sheave with the rubber drive wheel and slowly increase the speed of the drive unit until the governor is mechanically tripped (pawl has engaged the ratchet).

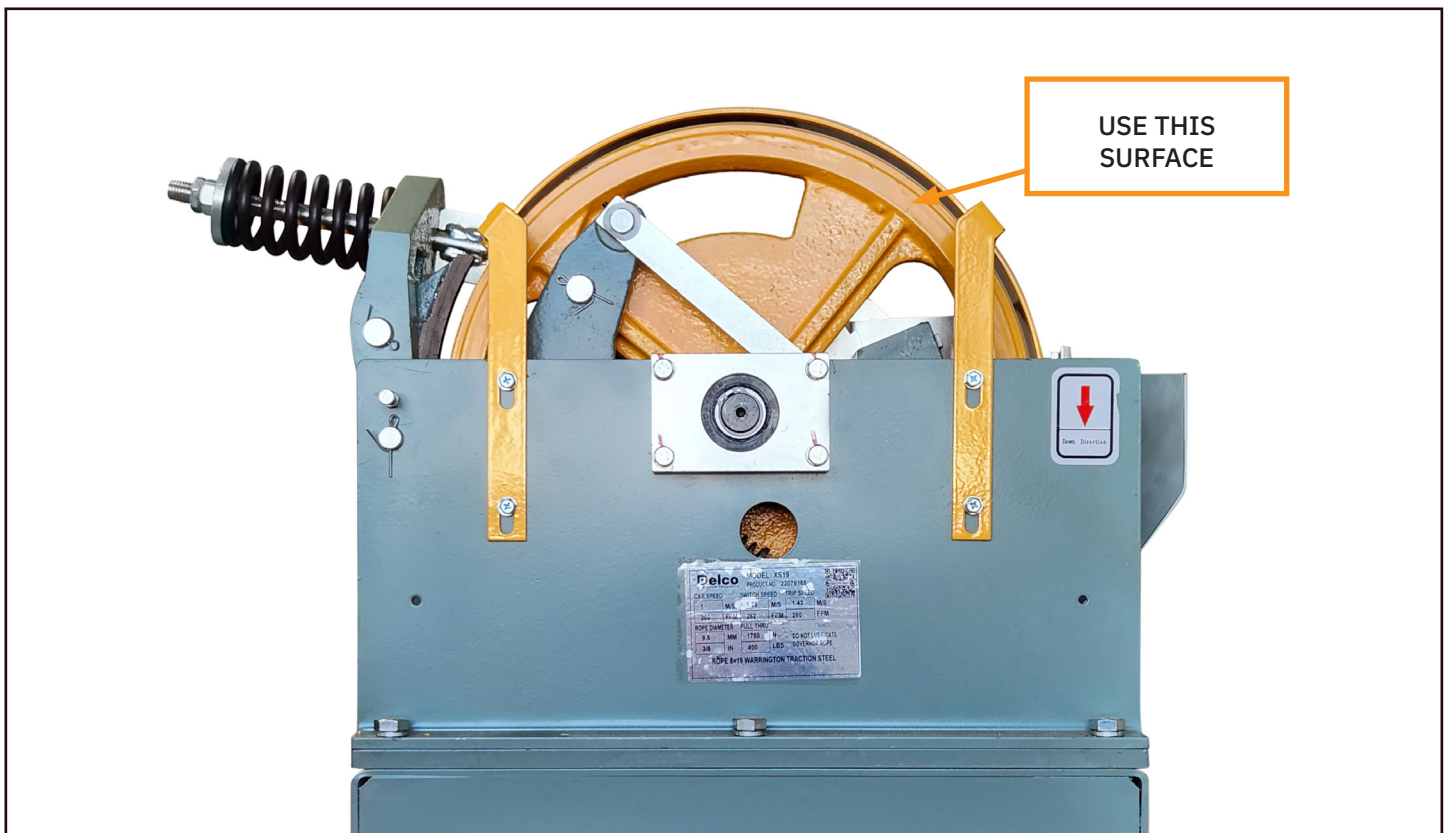

Figure 1

MAINTENANCE

Twice a month:

- Apply lubricant at all lubrication points shown in figure 1.

Quarterly :

- Check visually all the linkages, springs, split rings and cotter pins and other fasteners to ensure they are not missing or becoming loose.
- Clean the governor groove and wire ropes to remove extra grease.
- Visually check the fastening of the governor to the support structure.

Every 6 months:

- Visually check the pawl, ratchet and main sheave groove and governor shoe for signs of significant wear or damage.
- Inspect the governor rope to follow inspection procedure recommended by the rope manufacturer.

Every two years:

- Test and verify rated and tripping speed

Every year:

- Perform periodical inspections and tests in accordance with the National Elevator Code (CSA B.44 or ASME 17.1) and the applicable local elevator codes to ensure the governor is in good condition and operates properly.
- Check the functionality of the overspeed switch from a mechanical and electrical point of view.

Lubrication

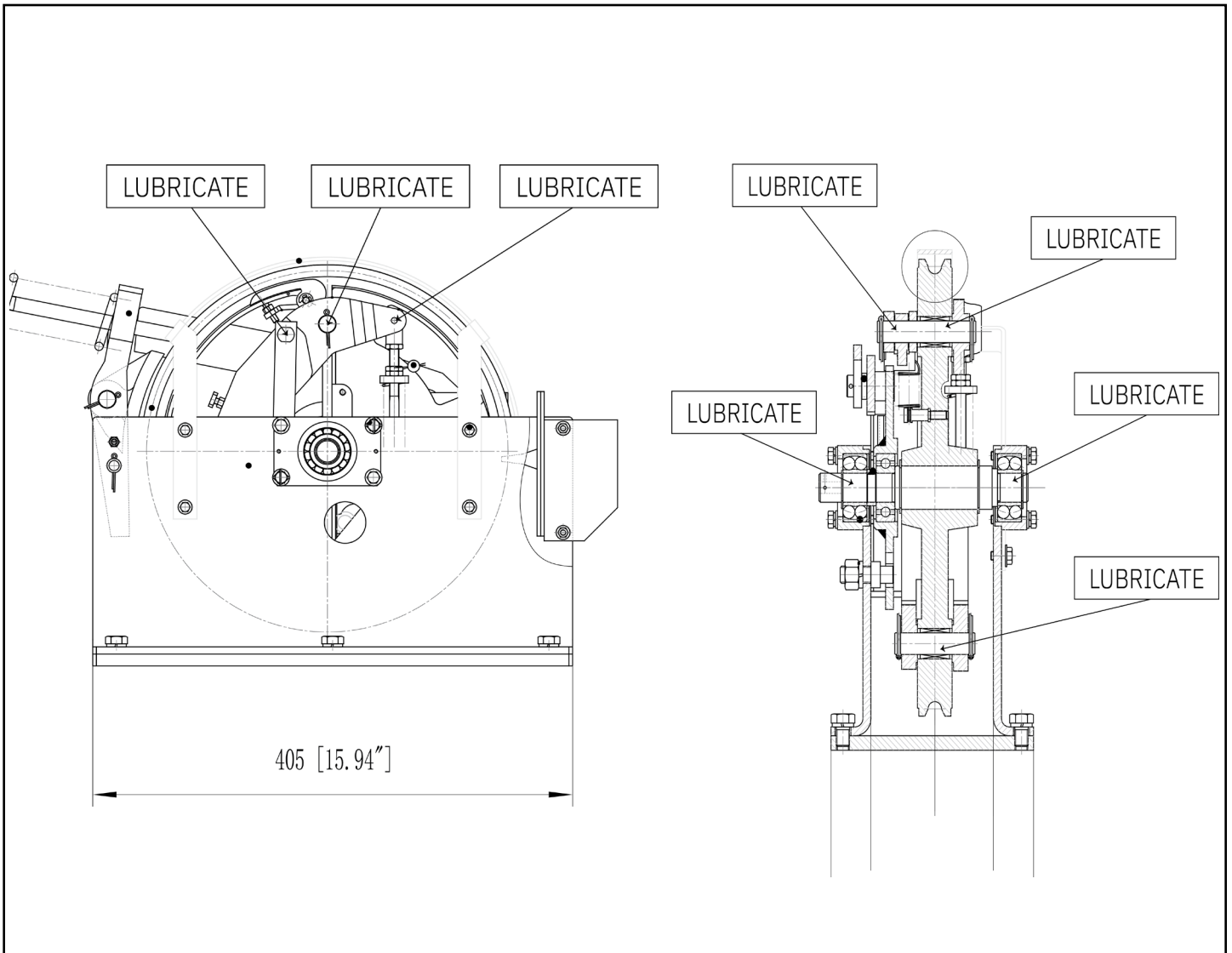

Figure 1

- Grease pawl every 3 months using a lithium based grease. For application in high humidity environment grease monthly. Ensure grease is spread evenly on the pawl and ratchet.
- Using a N46 type Hydraulic Oil lubricate every 15 day all the pin shafts , bushings, bearings at the points shown in Figure 1.