

Delco 1/2" x 30" Shackles

- 1. 1/2" (Ø13) rope size 8x19S+FC
- 2. According to CI, 2.20.9.5.1=80% of 14500 lbs. = 11600 lbs. for 1/2" Assy

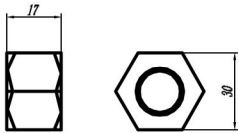

(1) M20 Nut

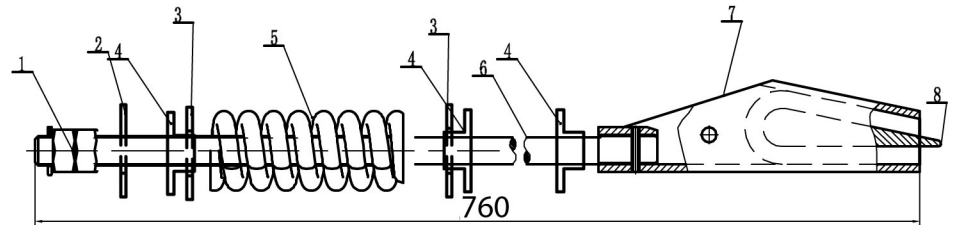

(2) M20 Washer

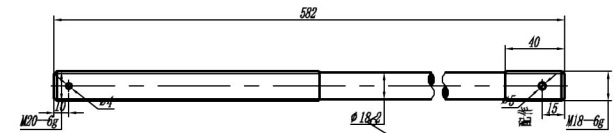

(6) M20 threaded shaft

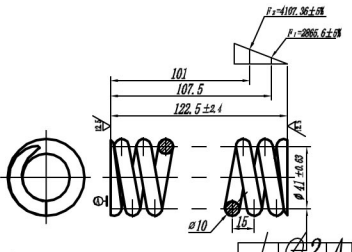

(5) Spring

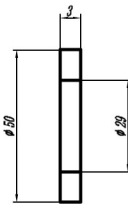

(3) M30 Washer

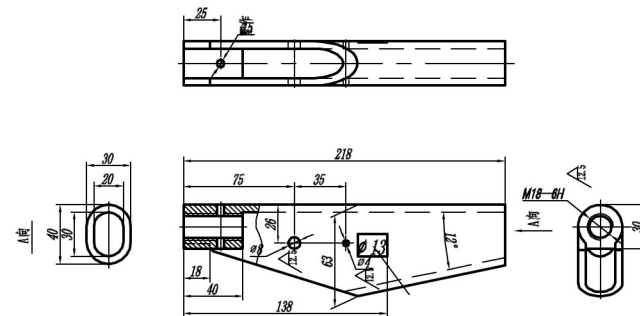

(7) Cast steel socket

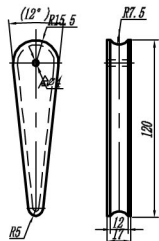

(8) 1/2" (Ø13) Wedge

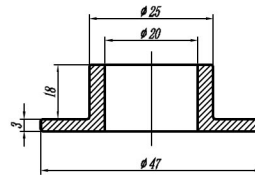

(4) Grommet/ Bushing

Shackle 1/2" (Ø13) long
(aprox. 24"rod. 30" total length)



1-866-900-3727
www.delcoelevator.com