



CARDO  
**FREECOM 2x**

.....  
**POCKET GUIDE**

**EN**



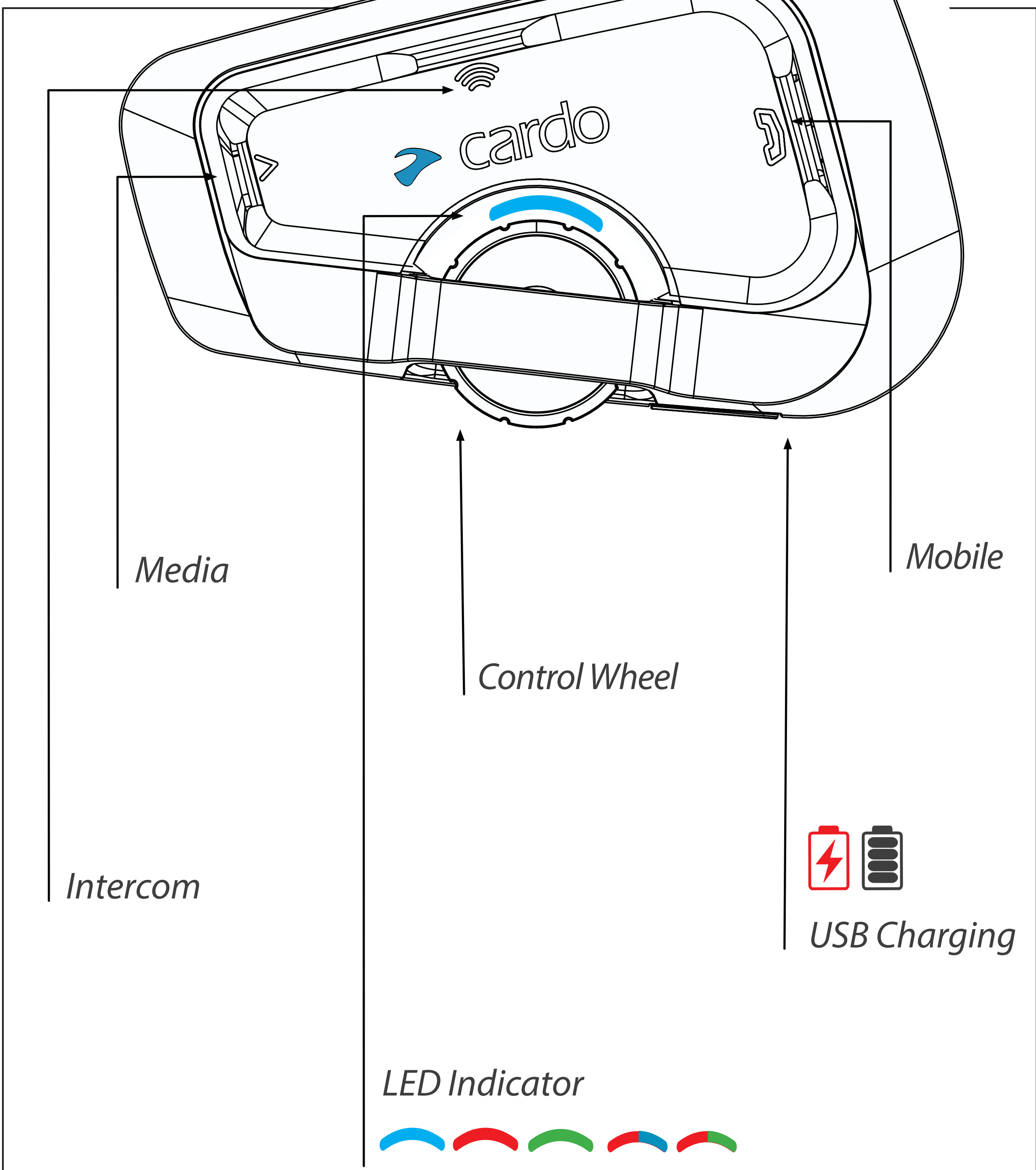

Press & Hold



Number of Taps

# Getting Started

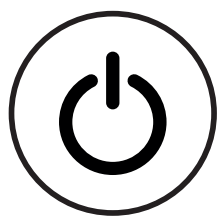

On / Off

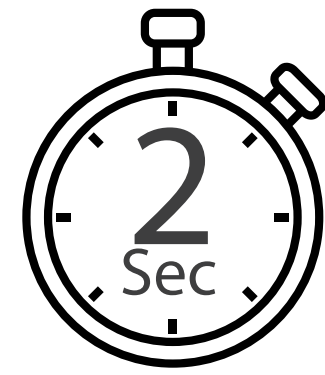
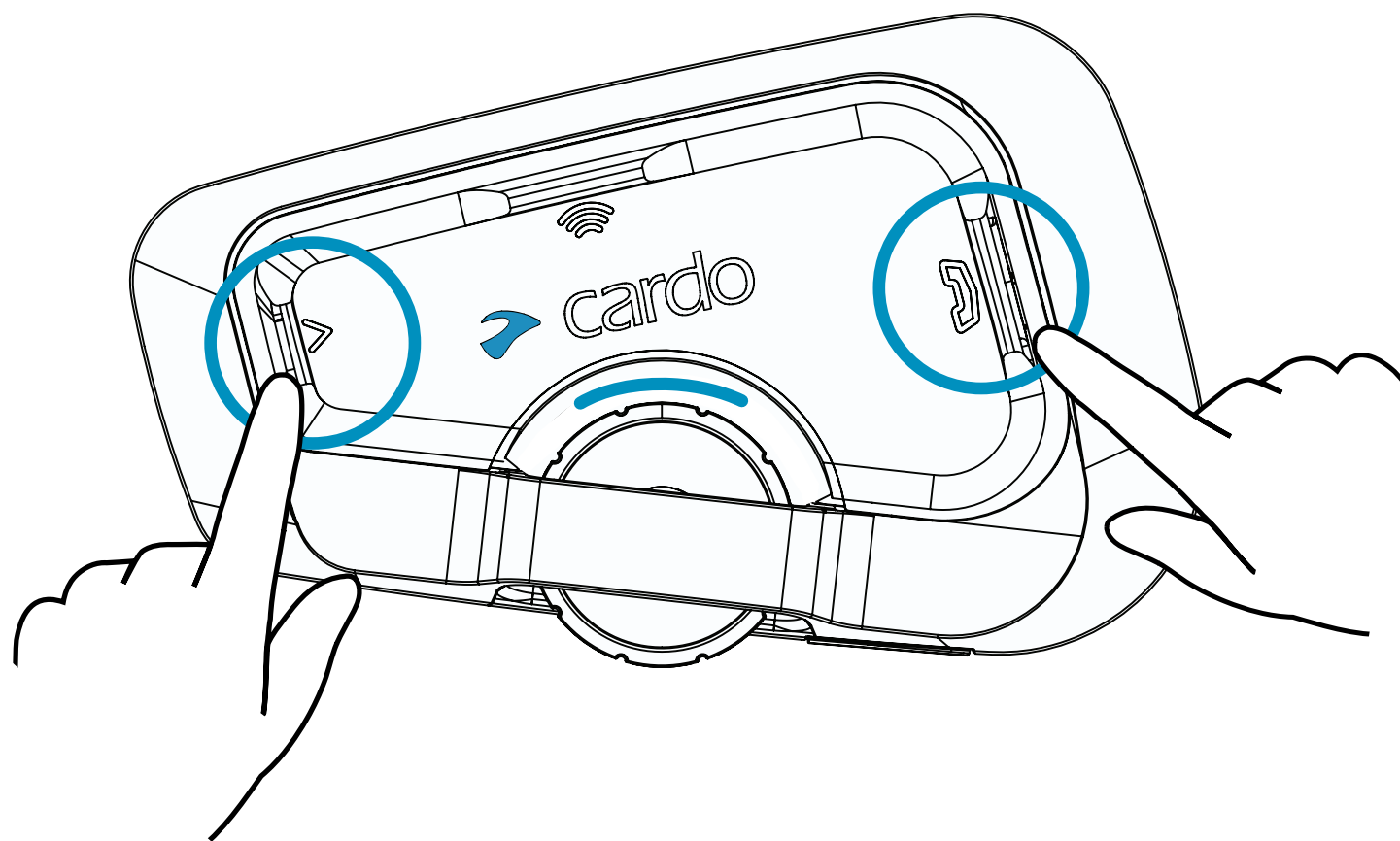

Phone Pairing

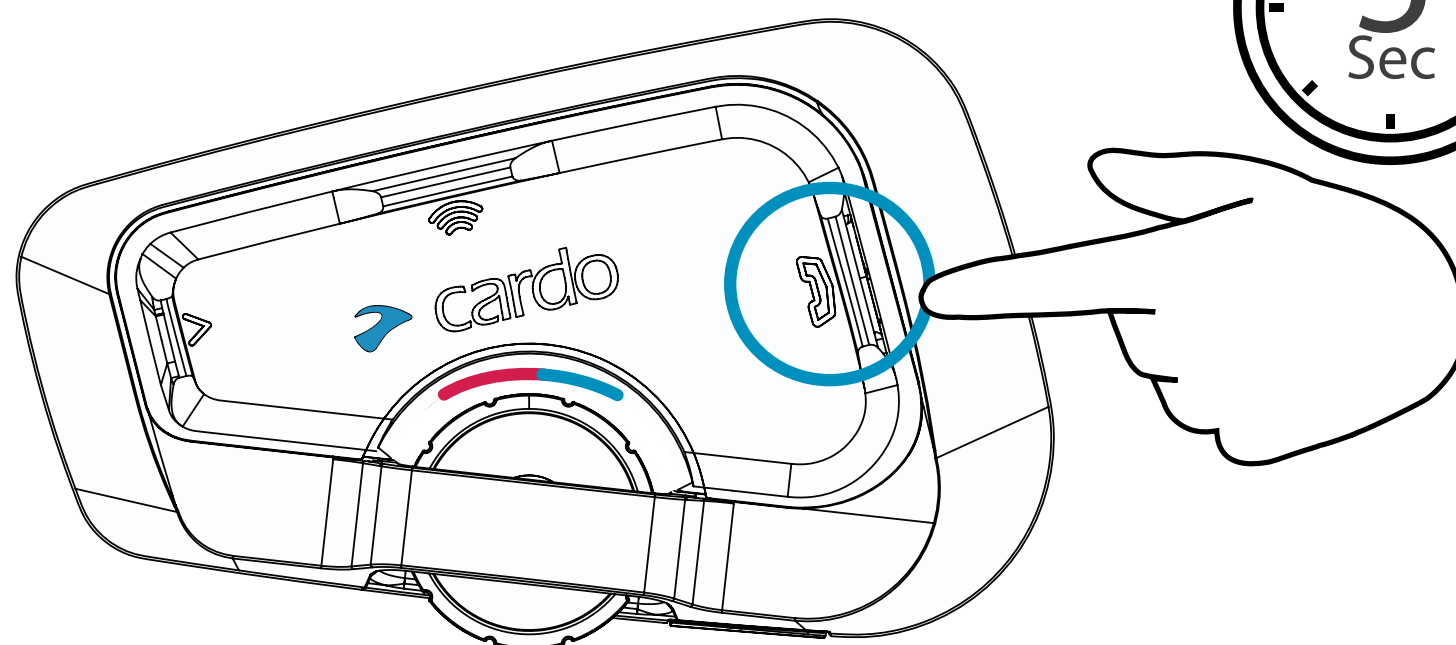

LED Red & Blue 





# Cardo Connect App

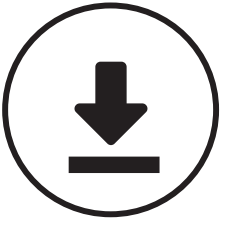

## Download



## Register

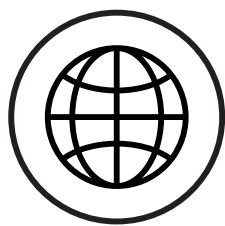
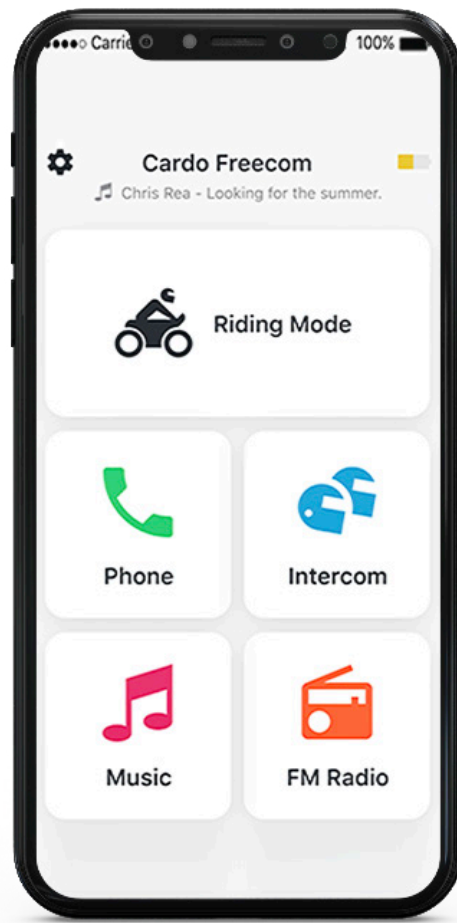

## Choose Language

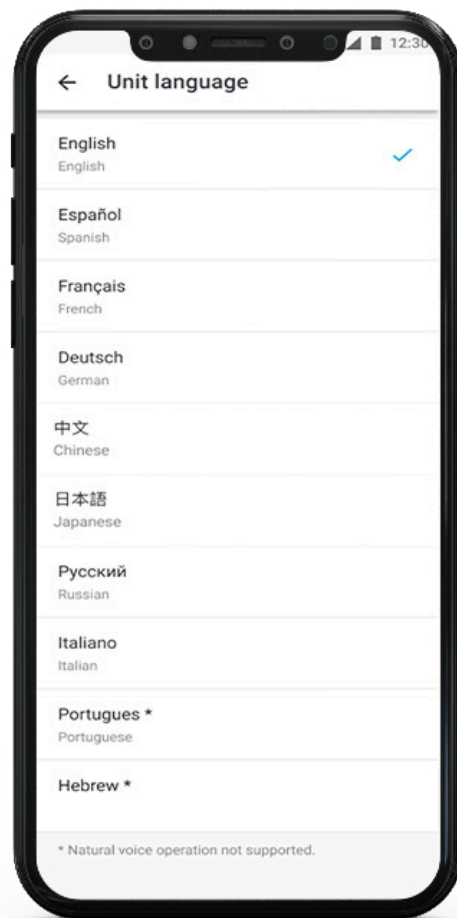

## Software Update

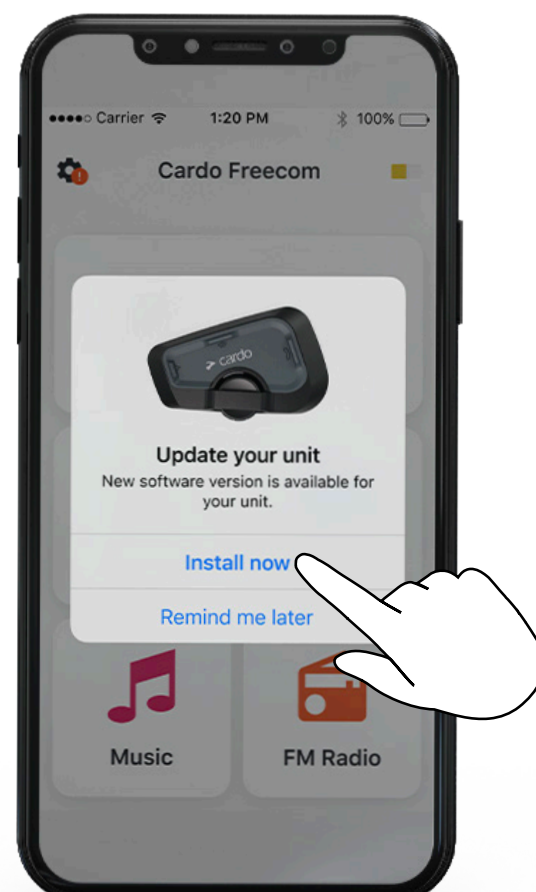

# General

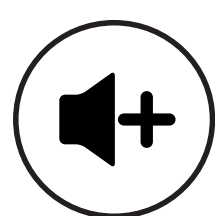

Volume Up

---

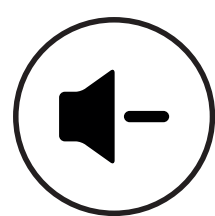
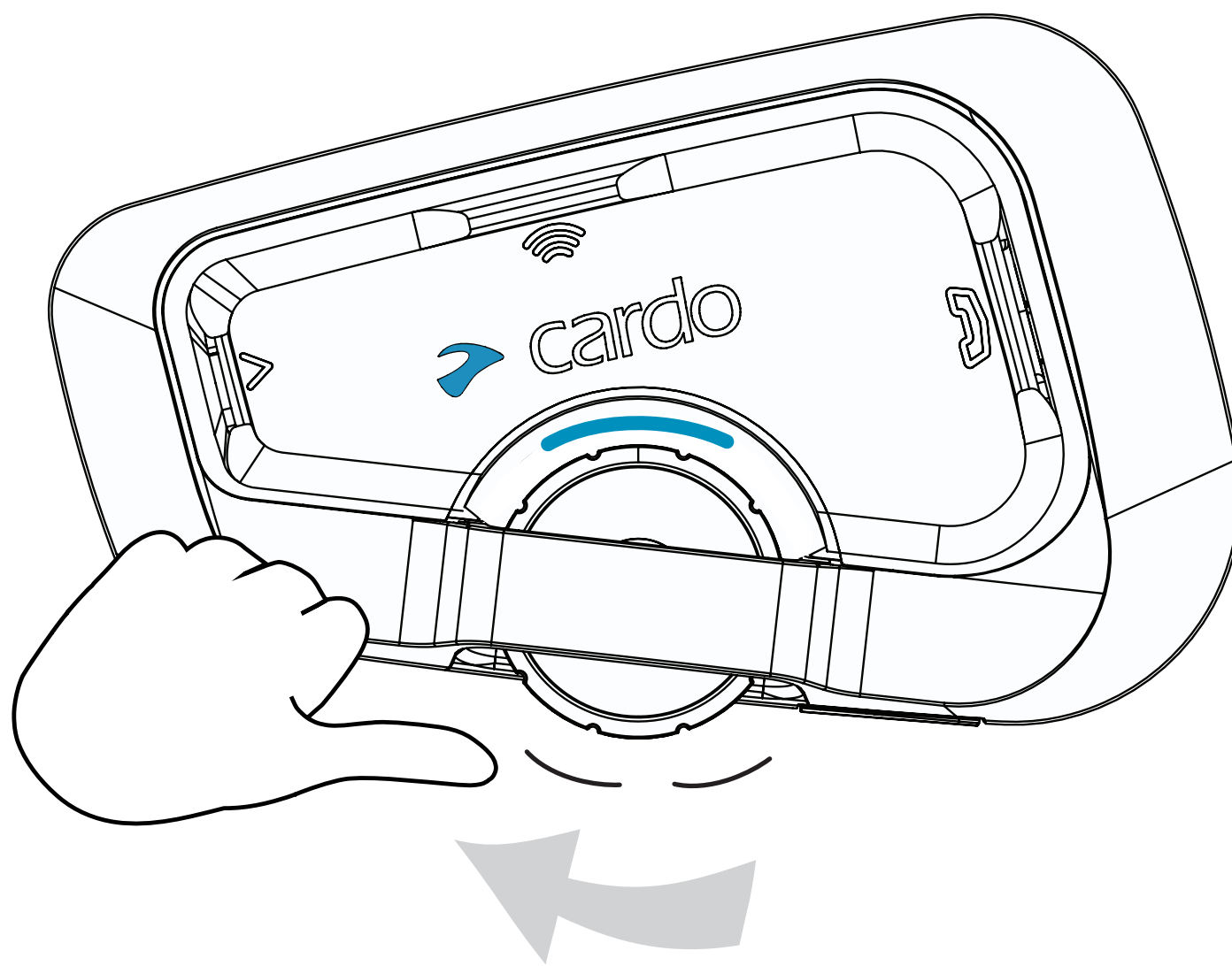

Volume Down

---

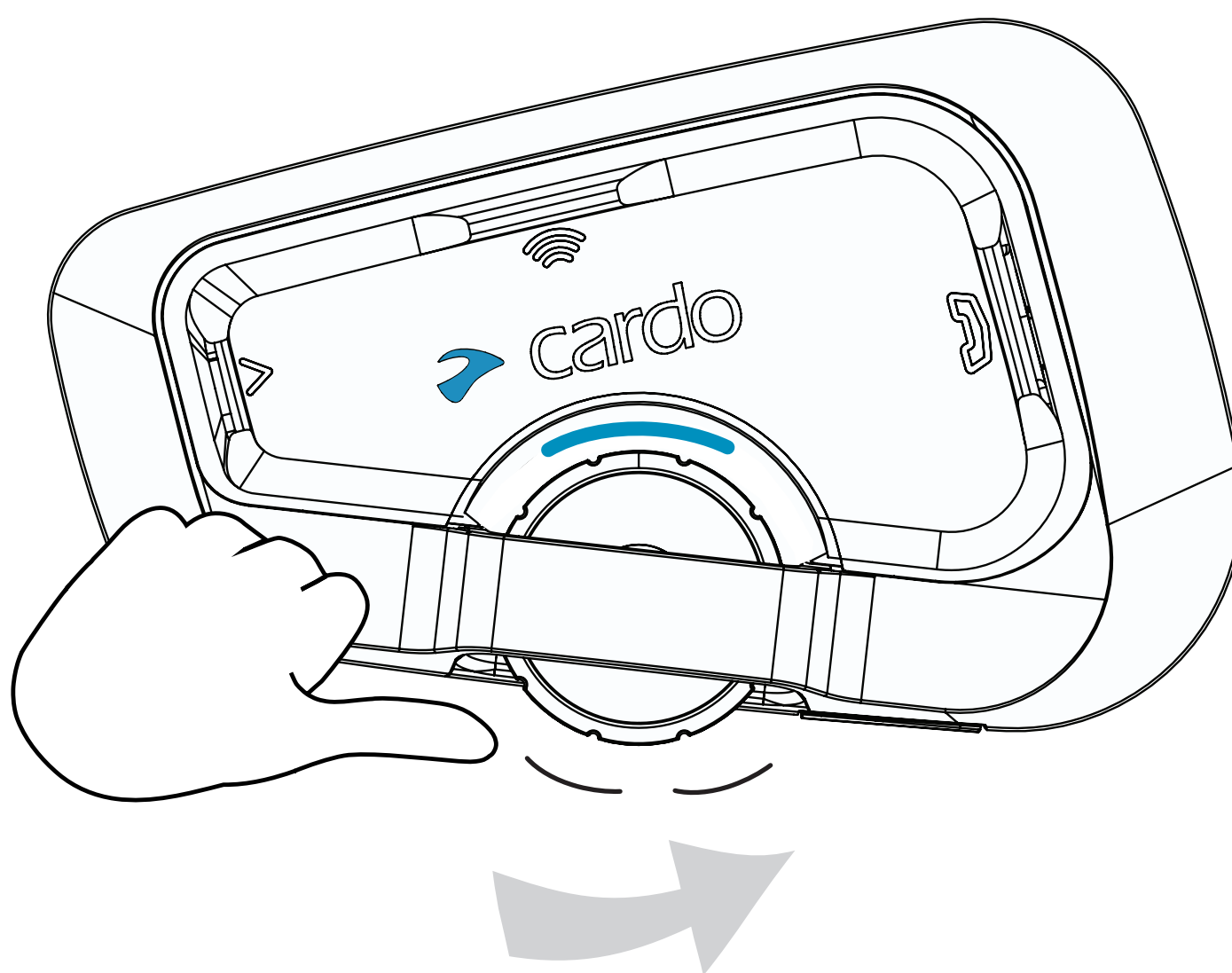

Voice Assistant

---

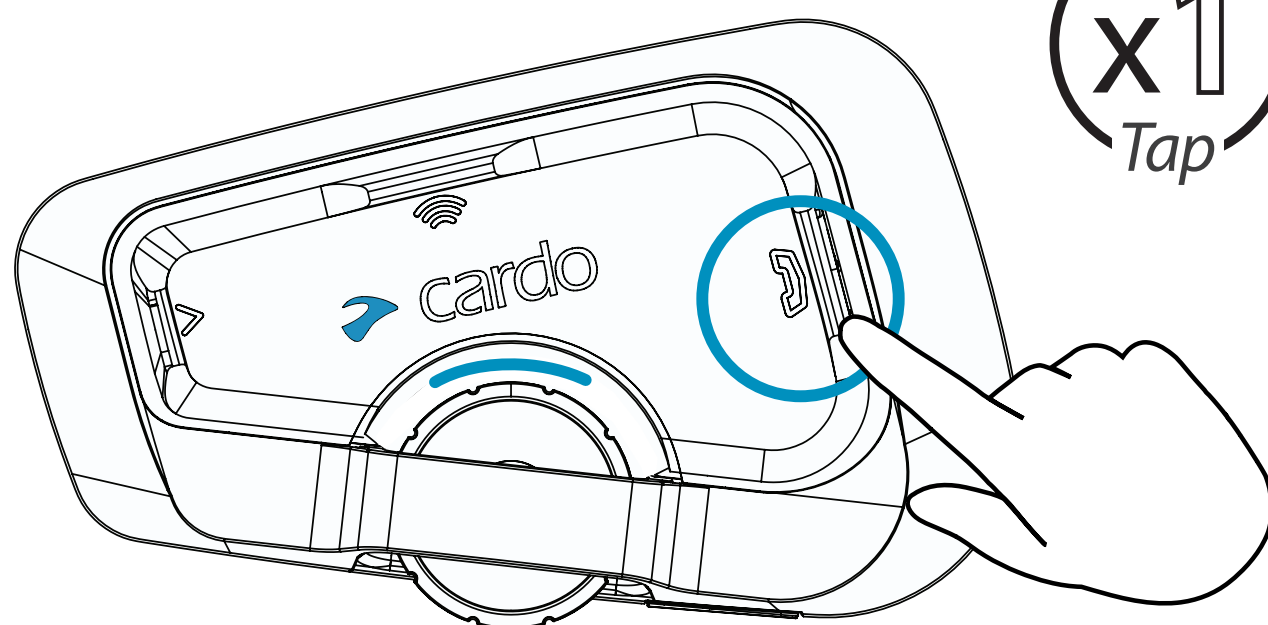
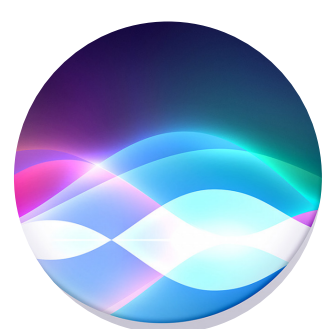



# Phone Call



Answer

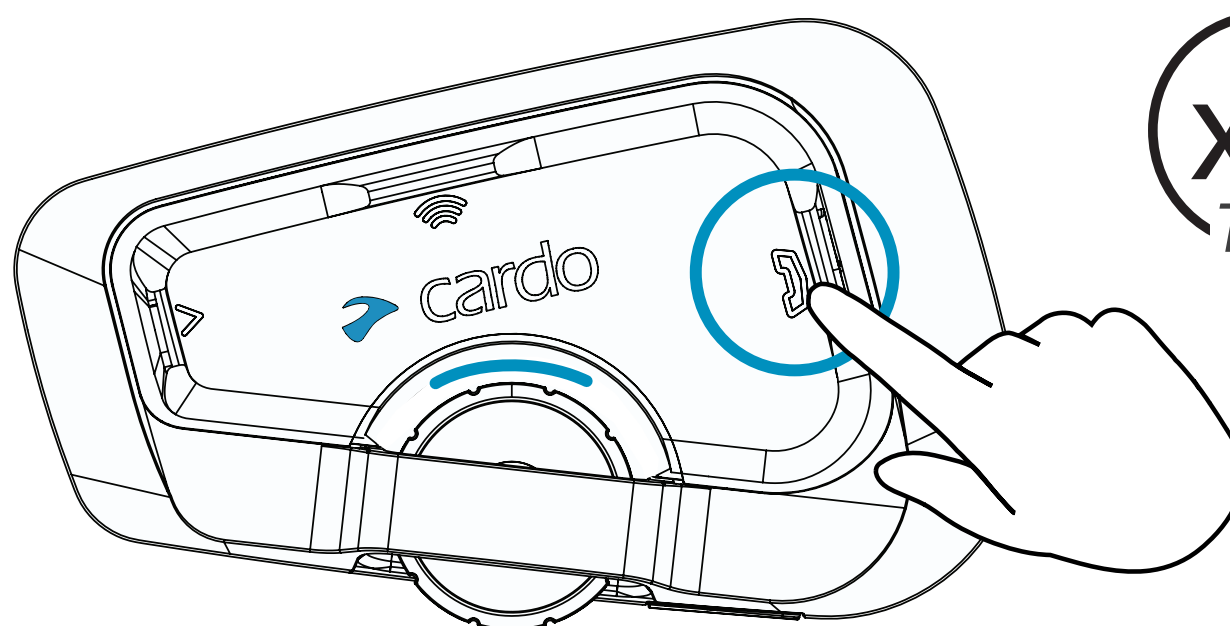

Ignore

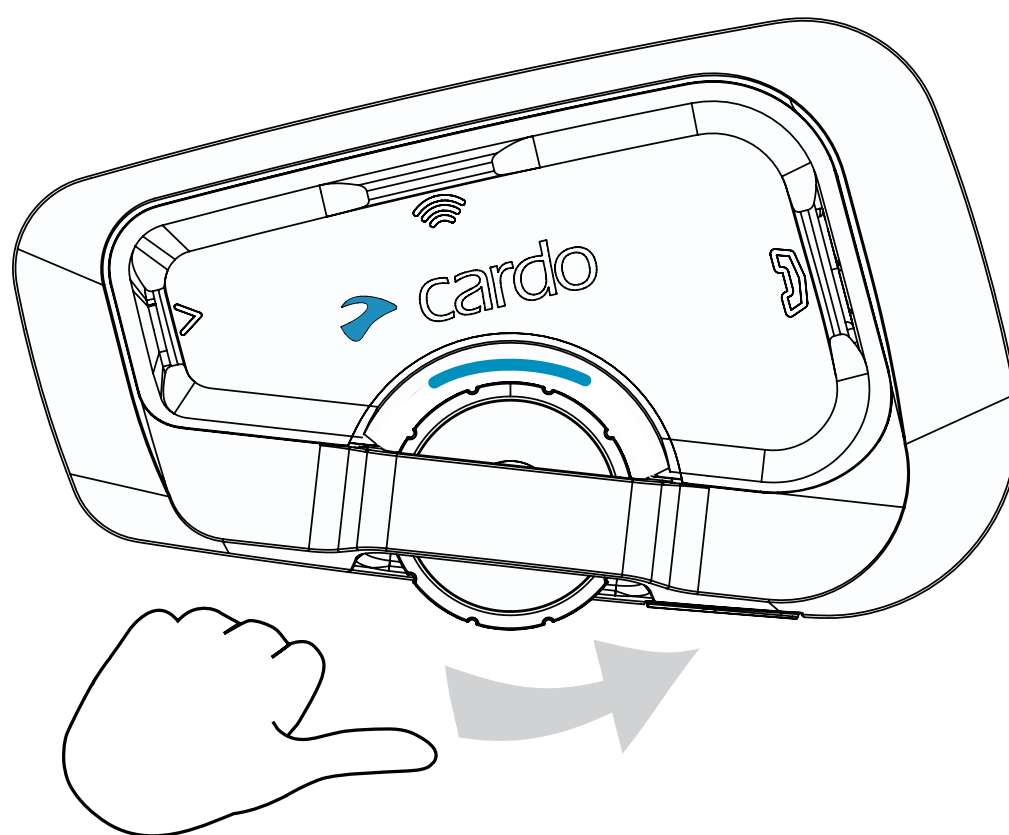

End Call

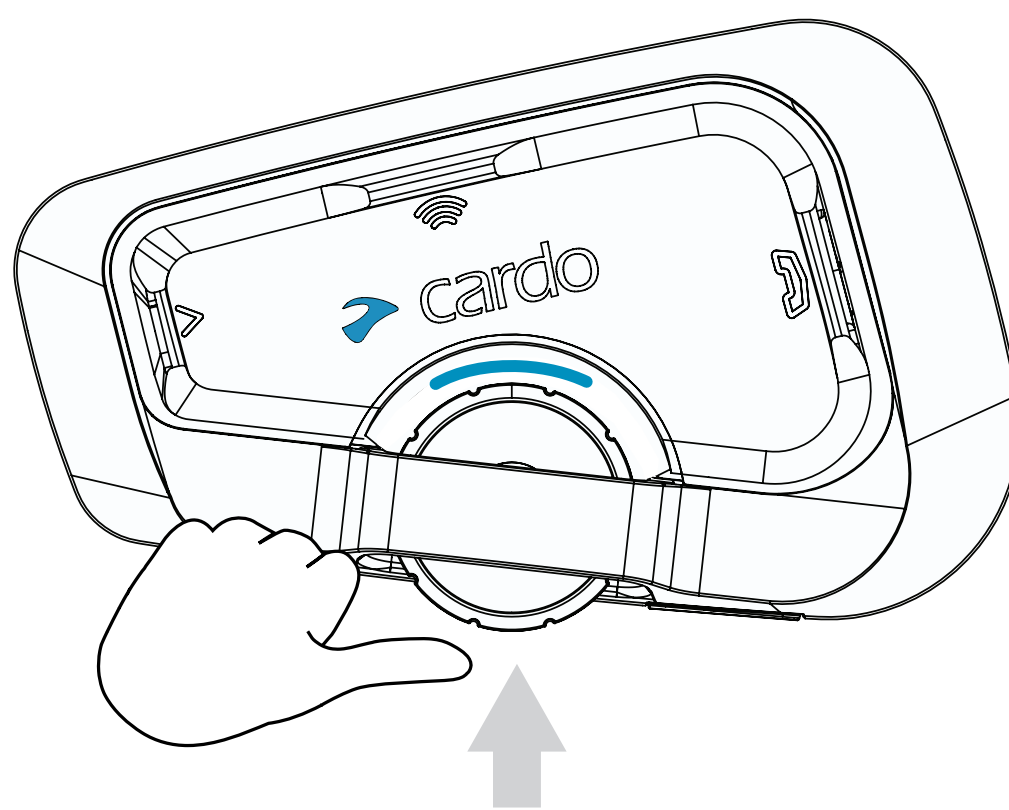

Redial

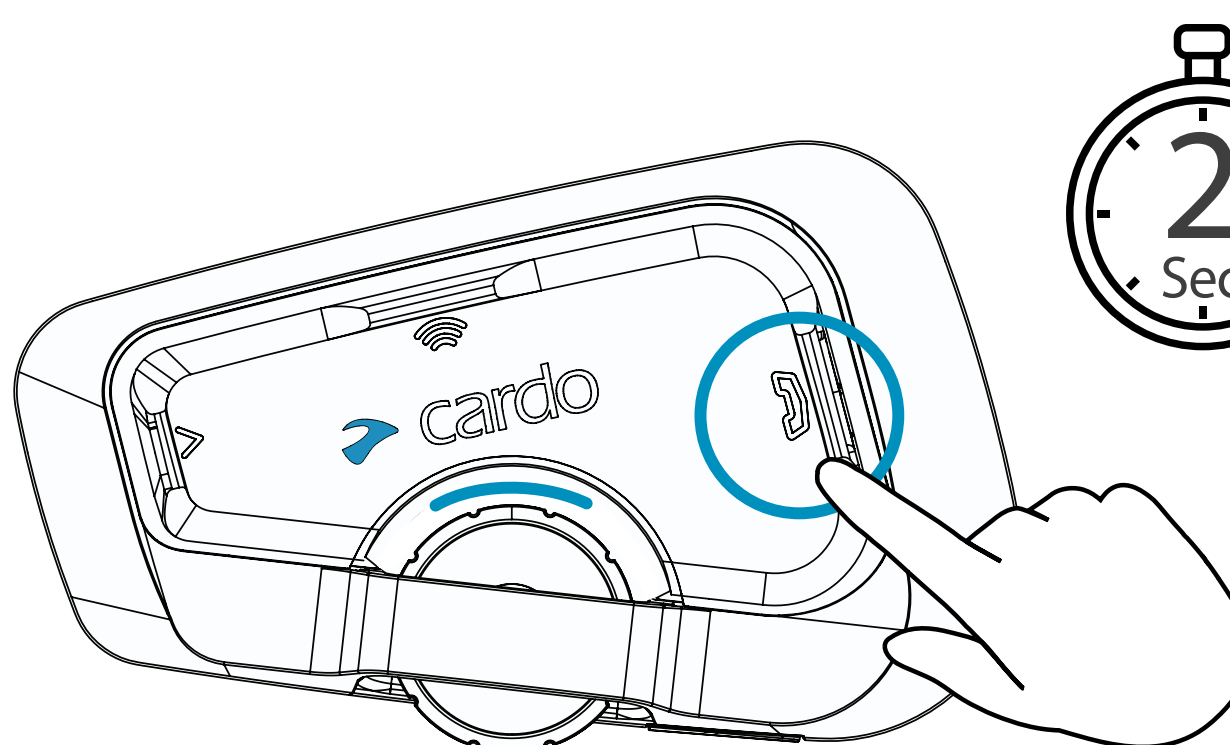

# Phone Call



## Speed Dial

Set Number

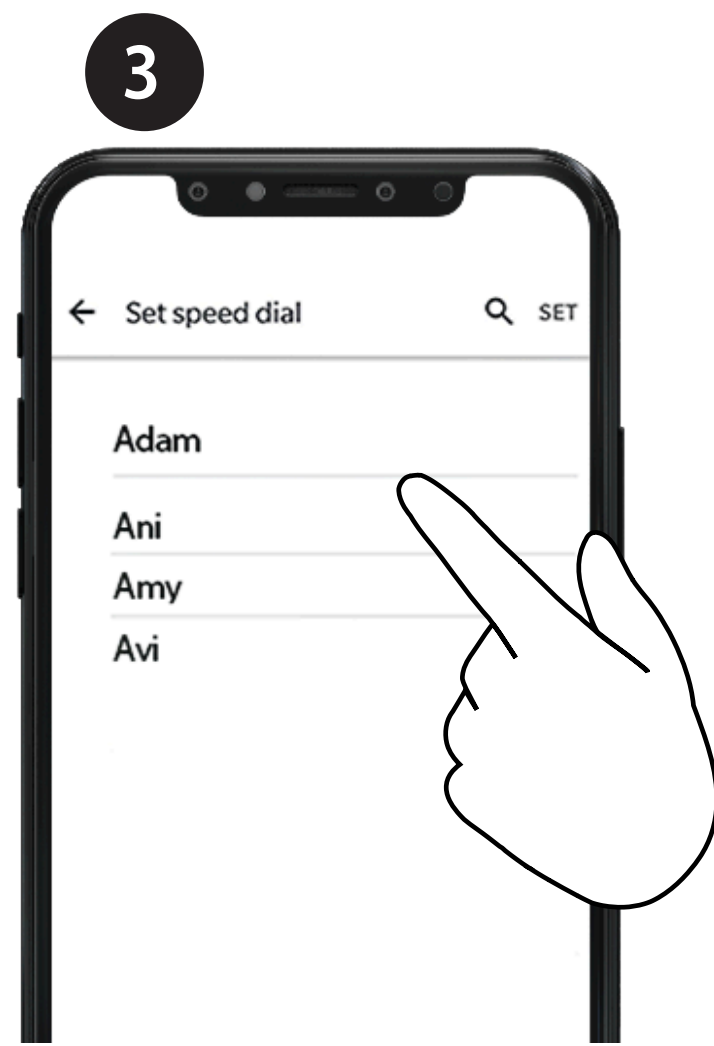
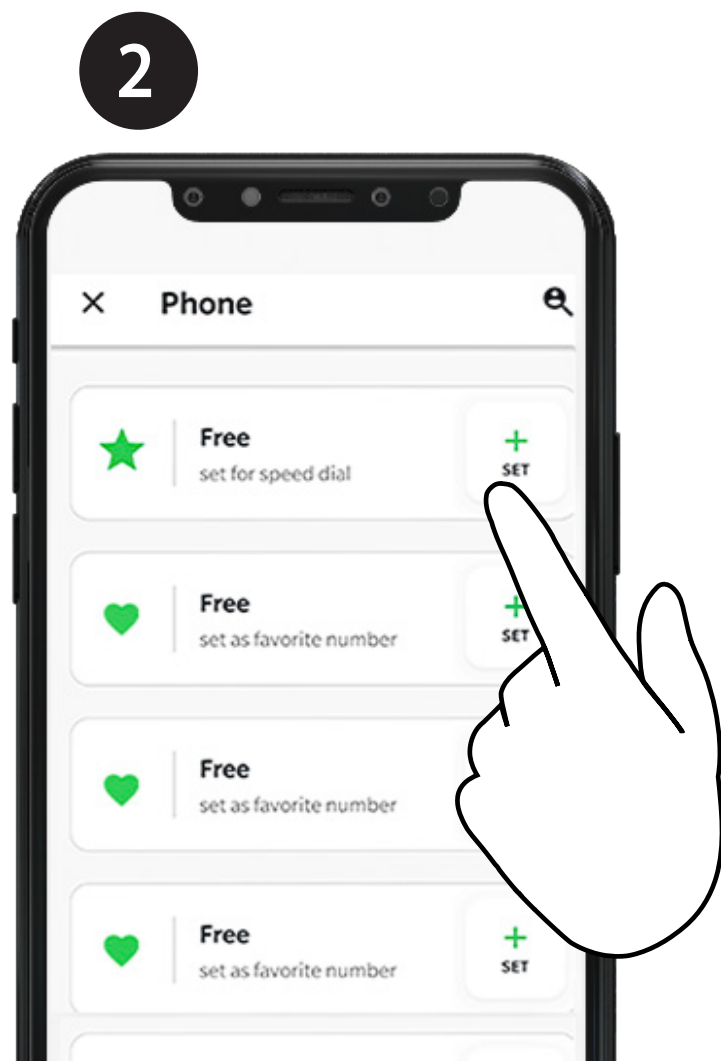
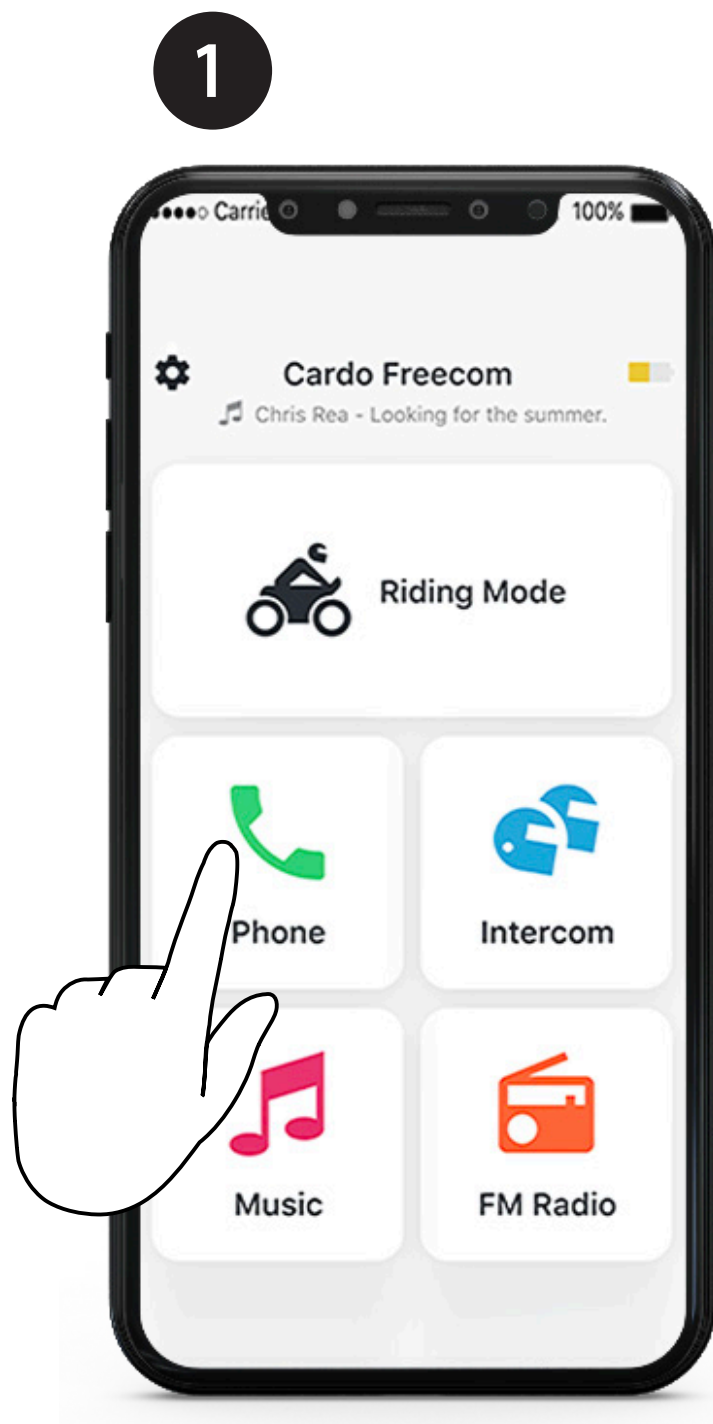

## Call Speed Dial

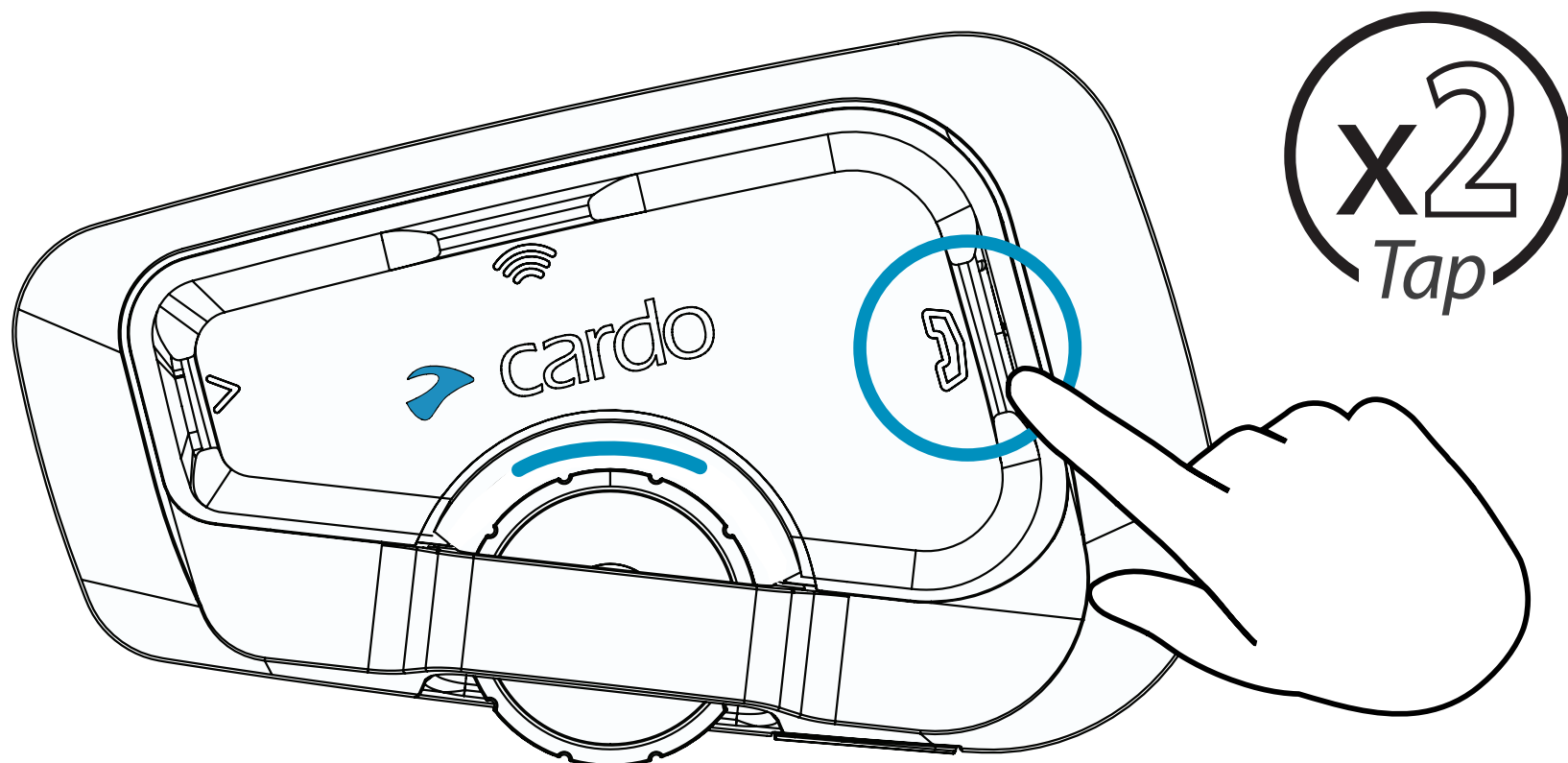

# Music

▶ Play

x1  
Tap

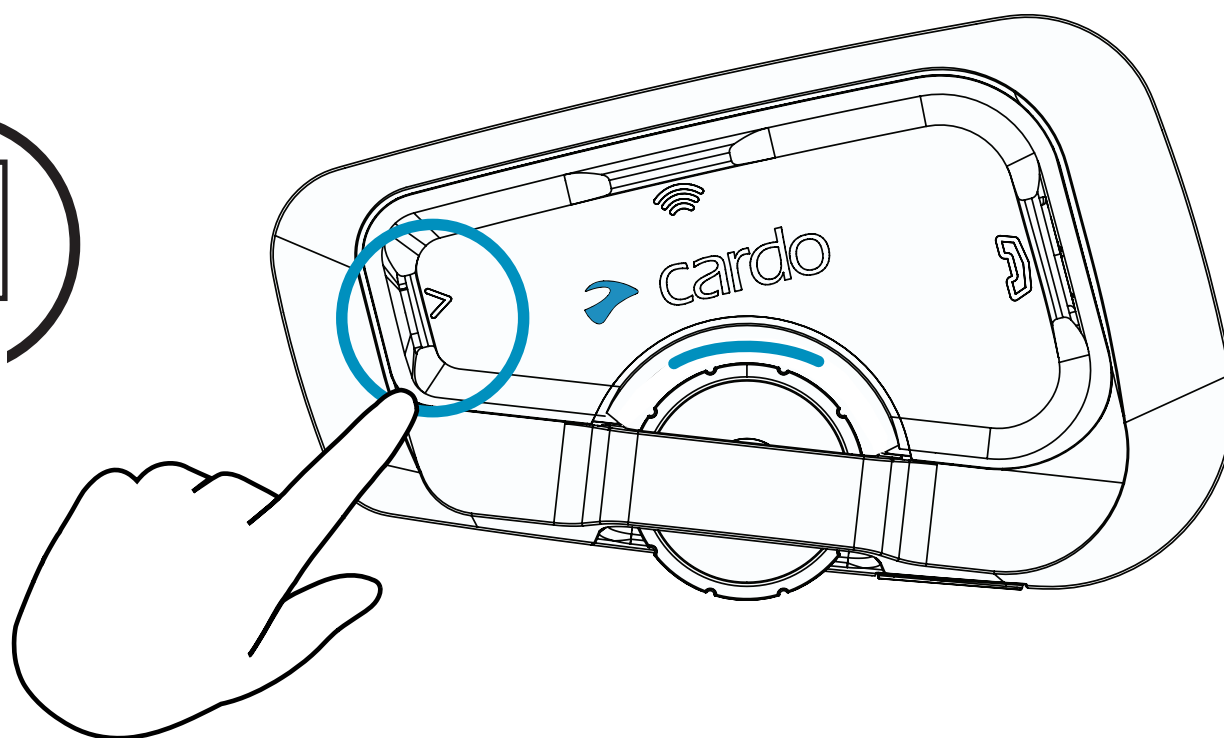

⏸ Pause

x1  
Tap

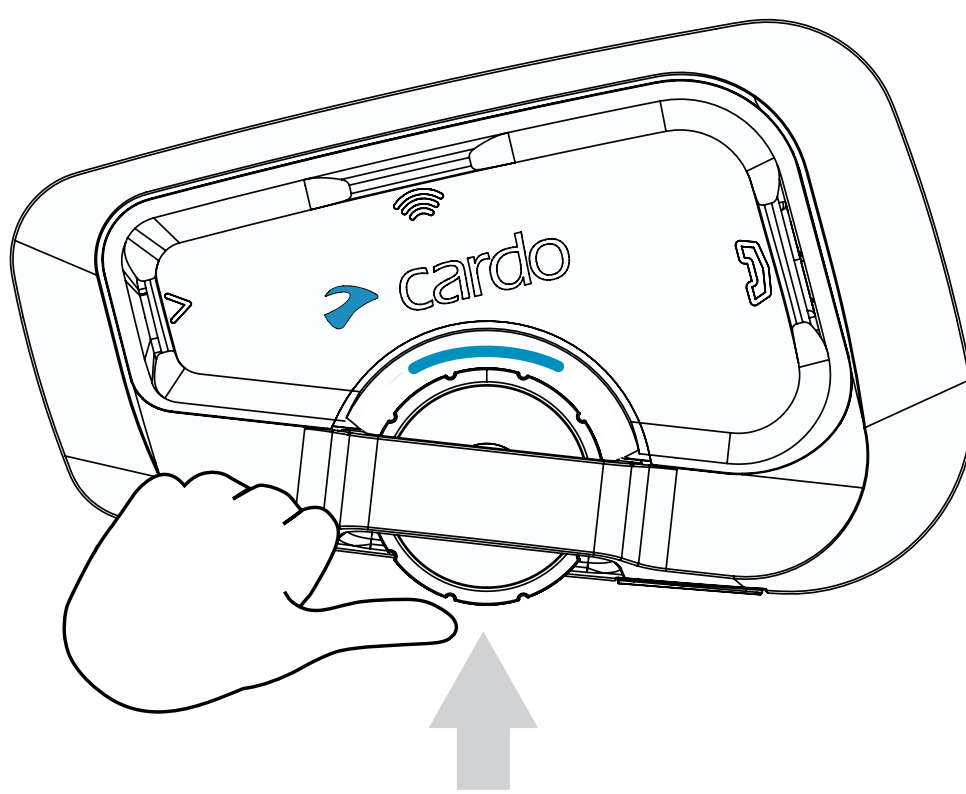

▶ Next

x1  
Tap

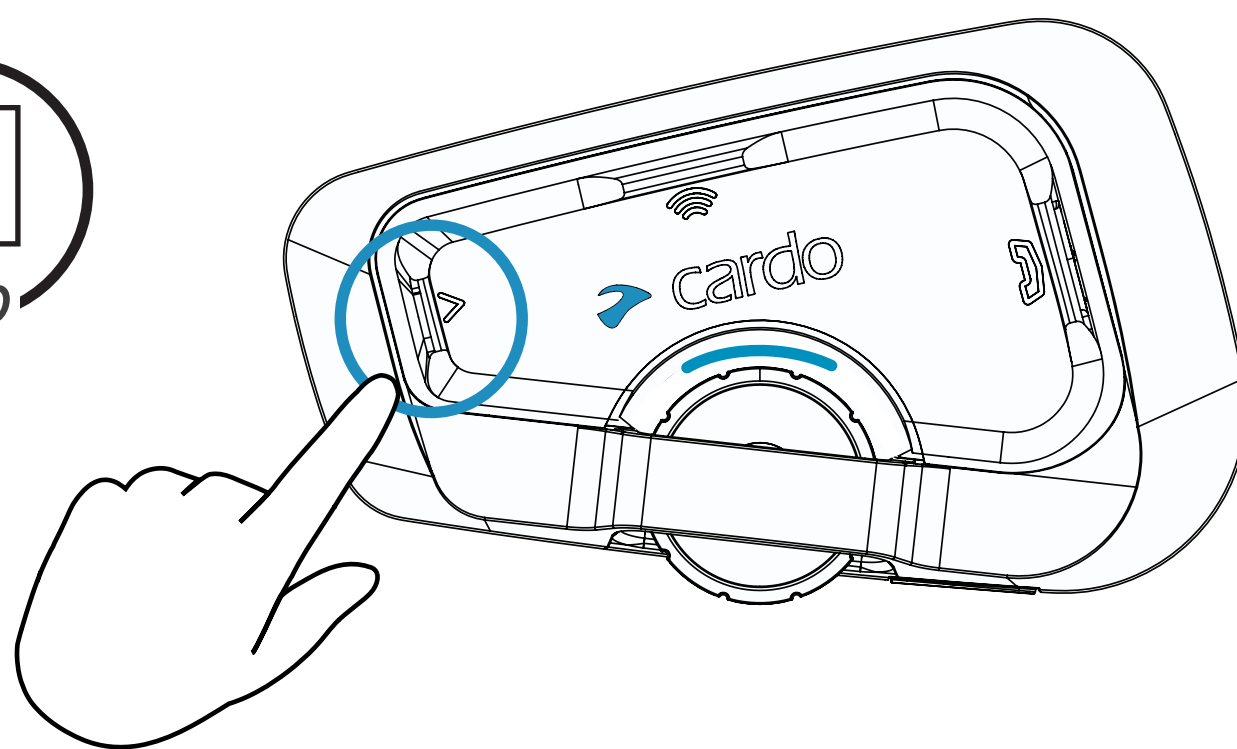

◀ Previous

x2  
Tap

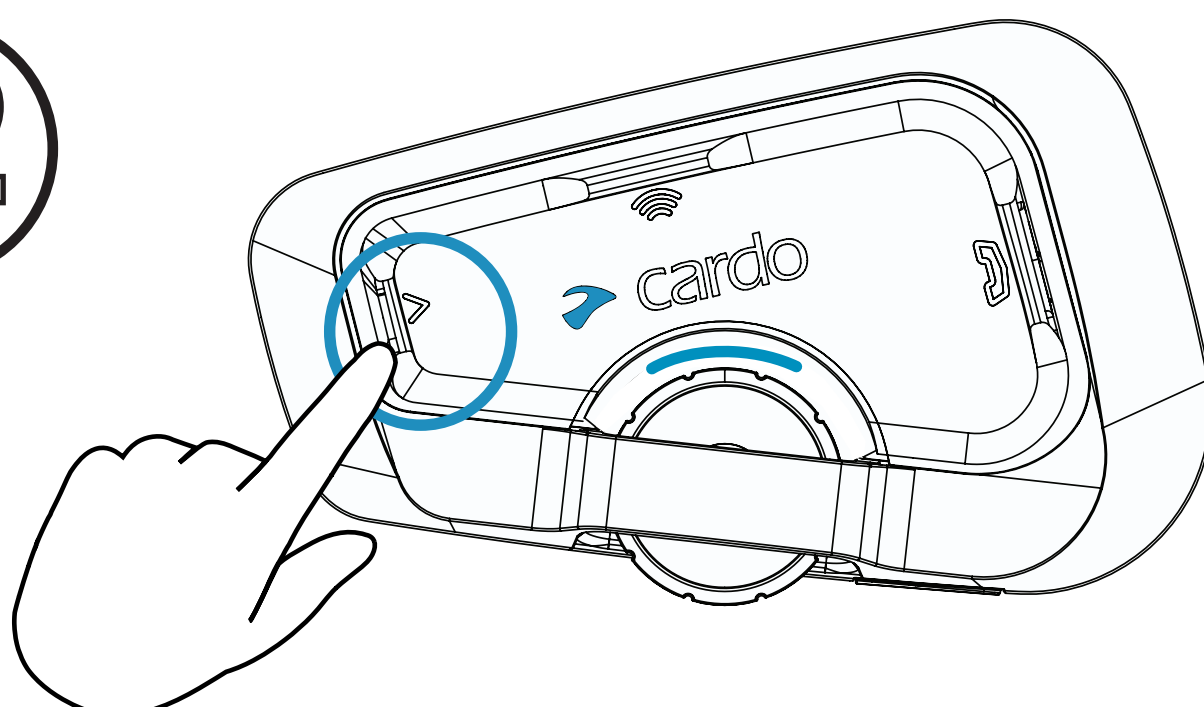



# Radio



## Set Presets

1

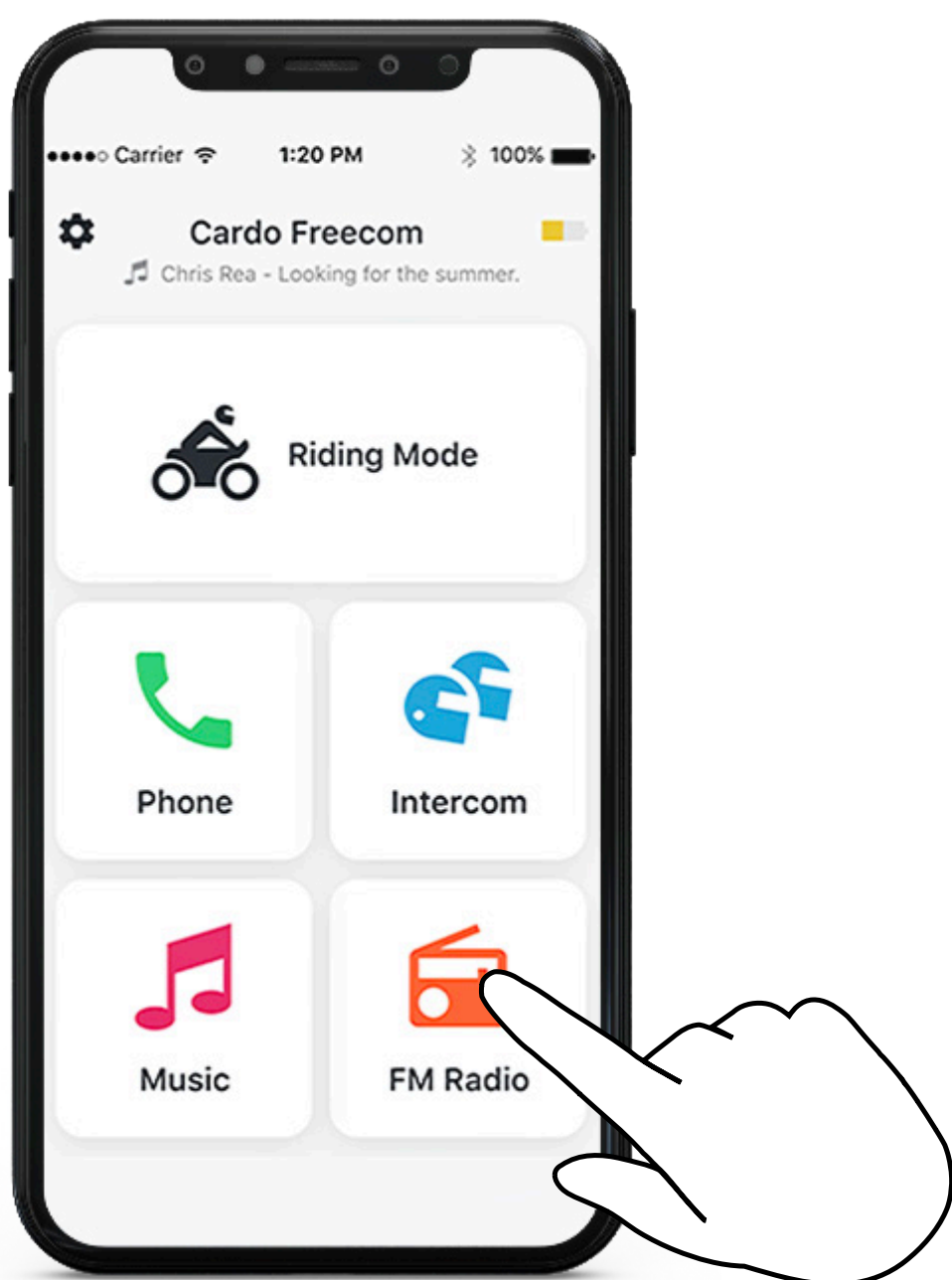

2

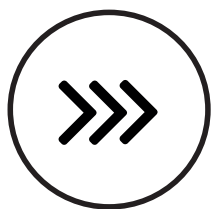
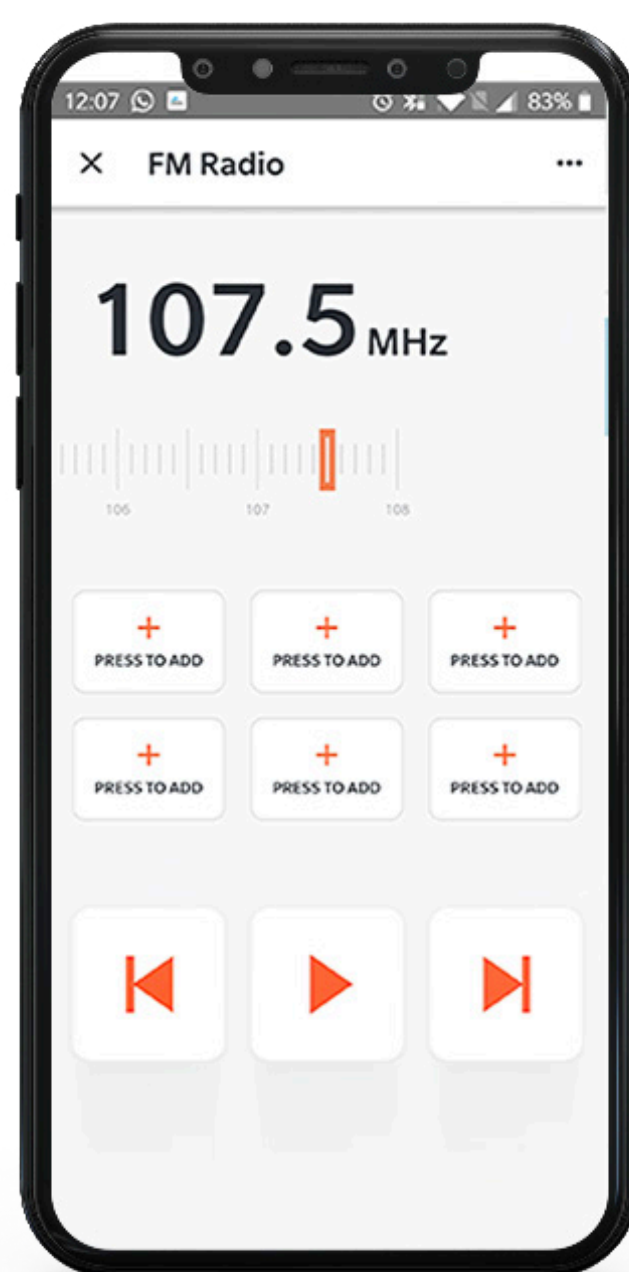

## Start Scan

X3  
Tap

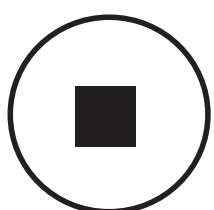
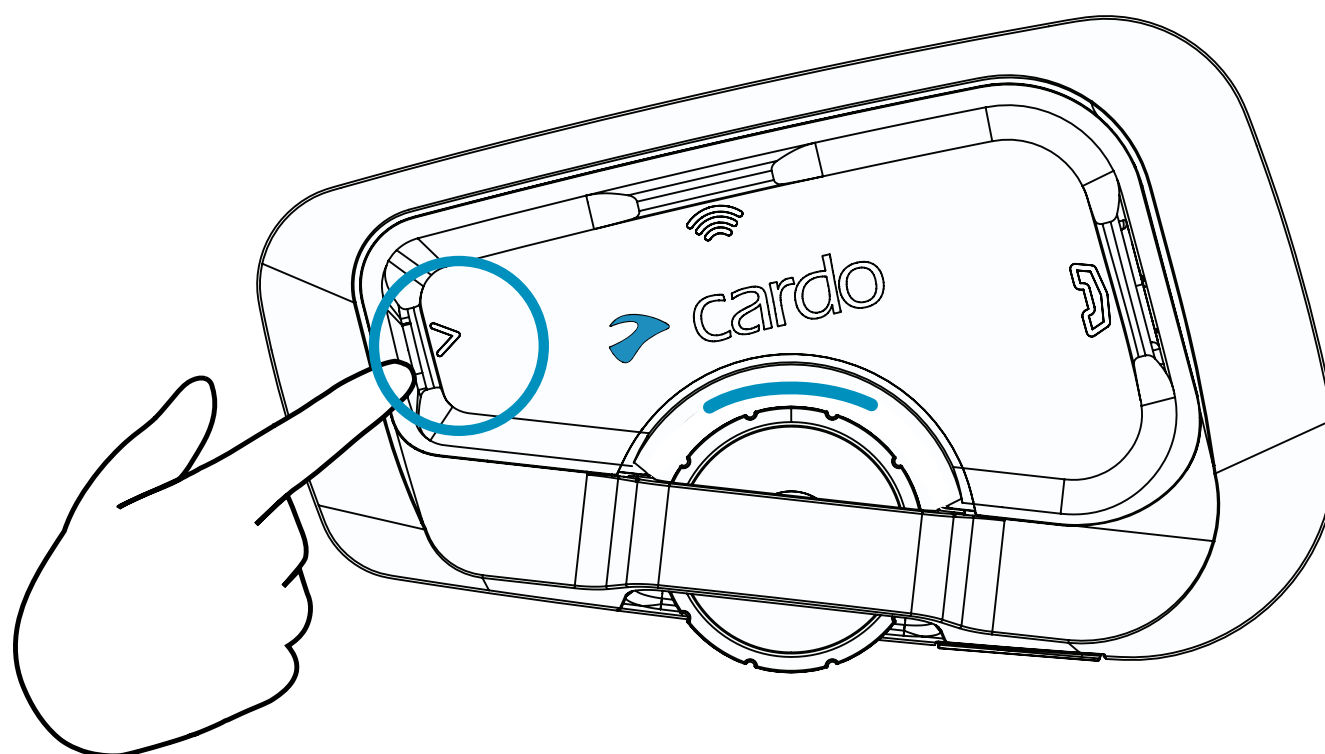

## Stop Scan

X1  
Tap

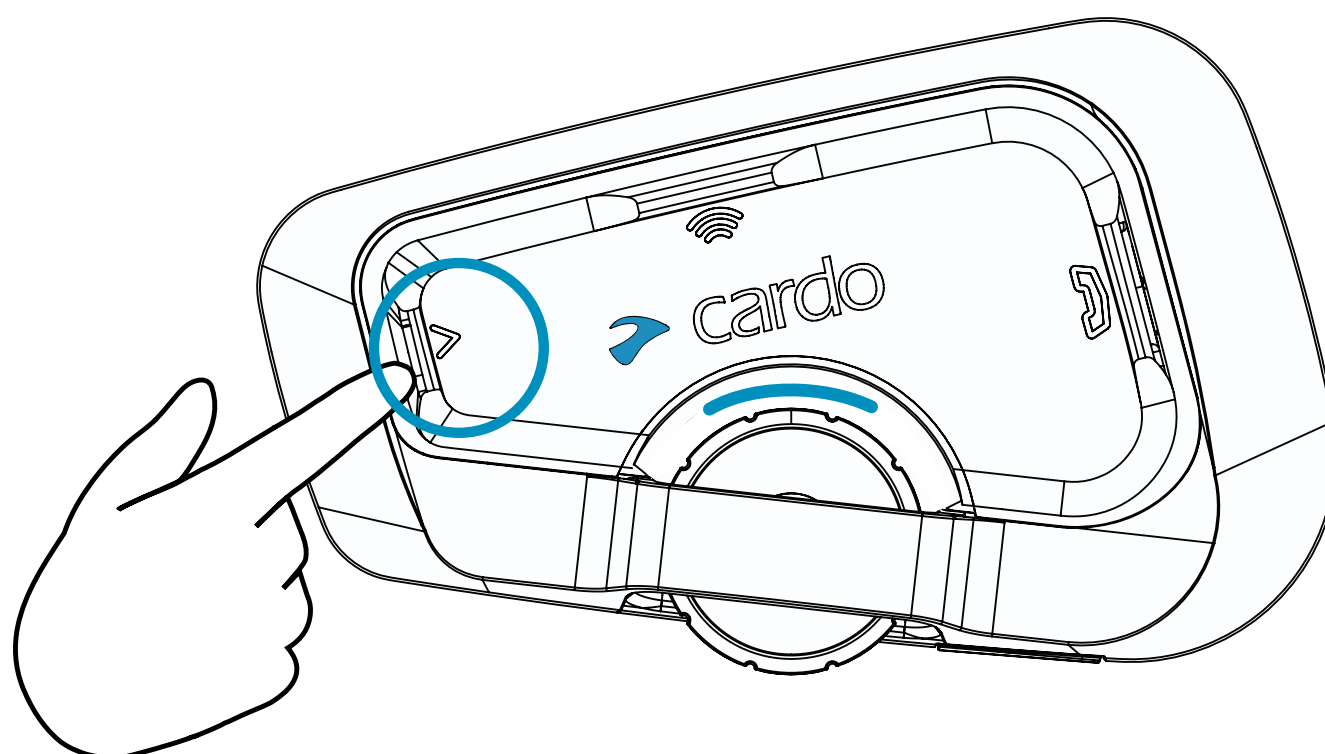

# Radio



On

---

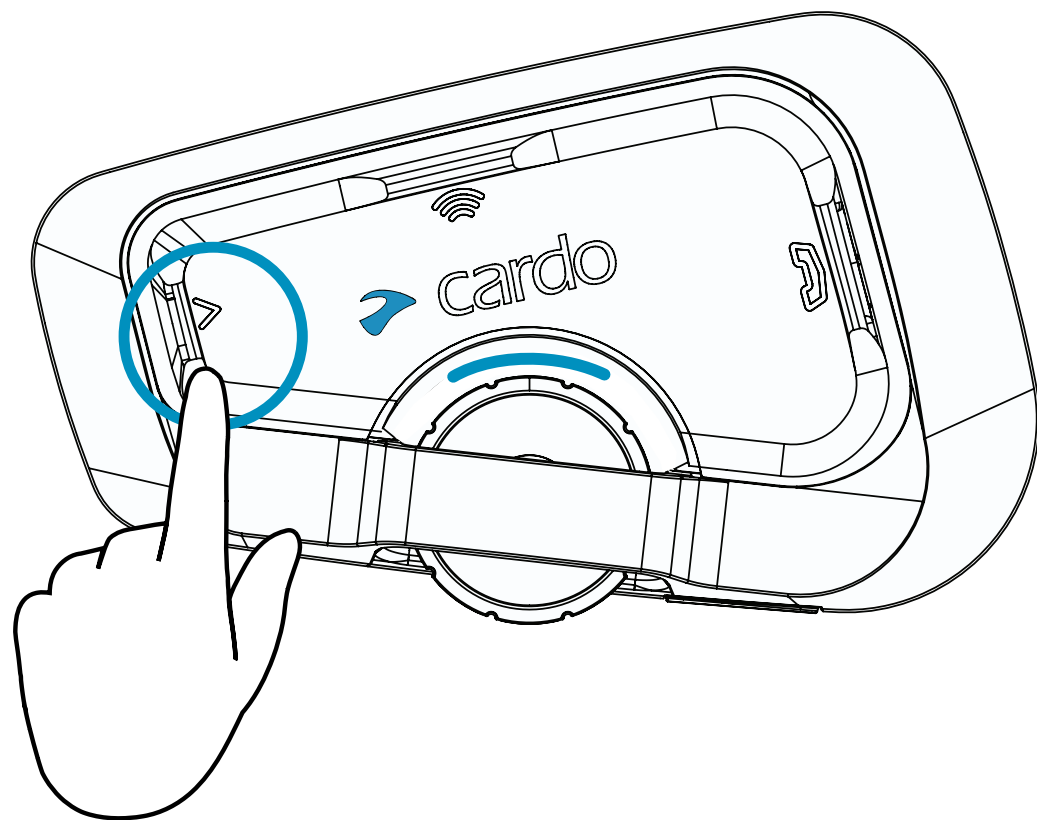

Off

---

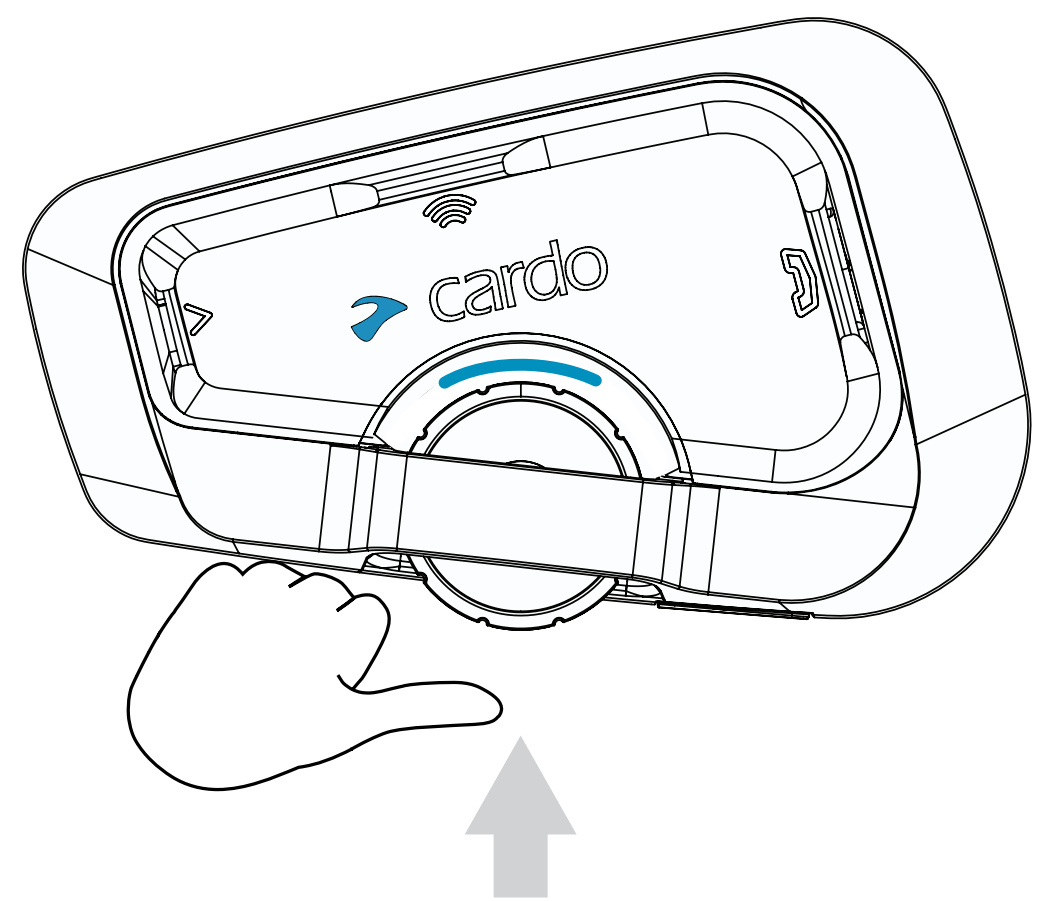

Next Preset

---

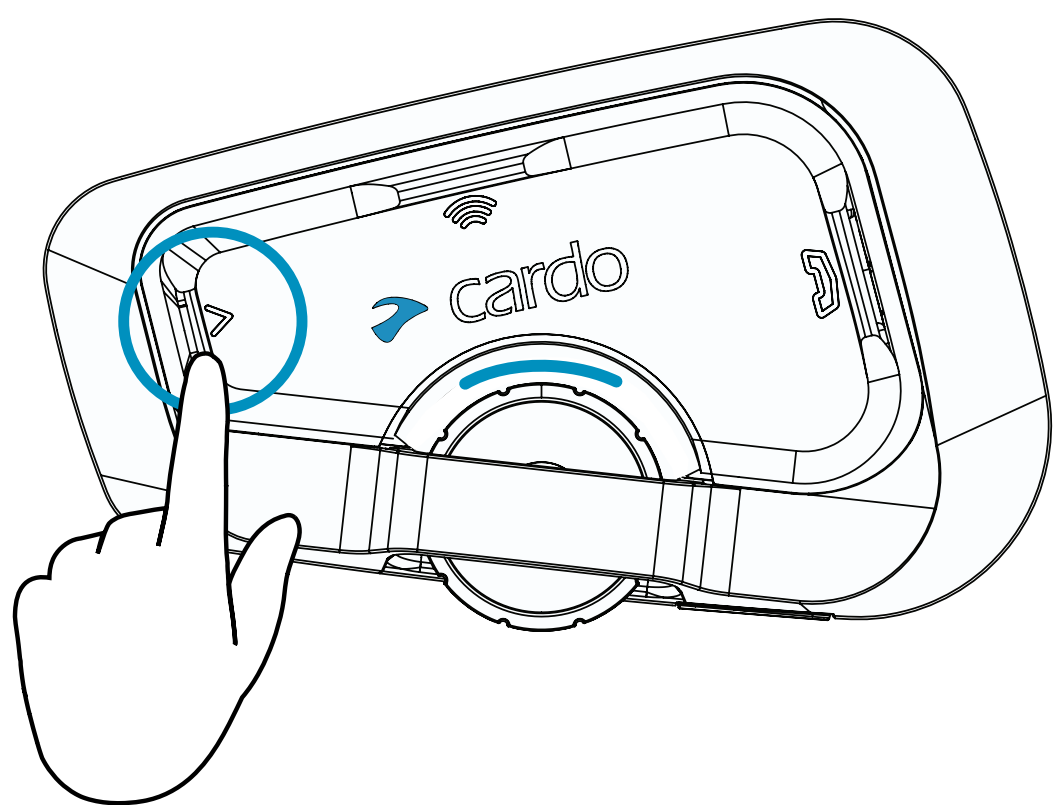

Previous Preset

---

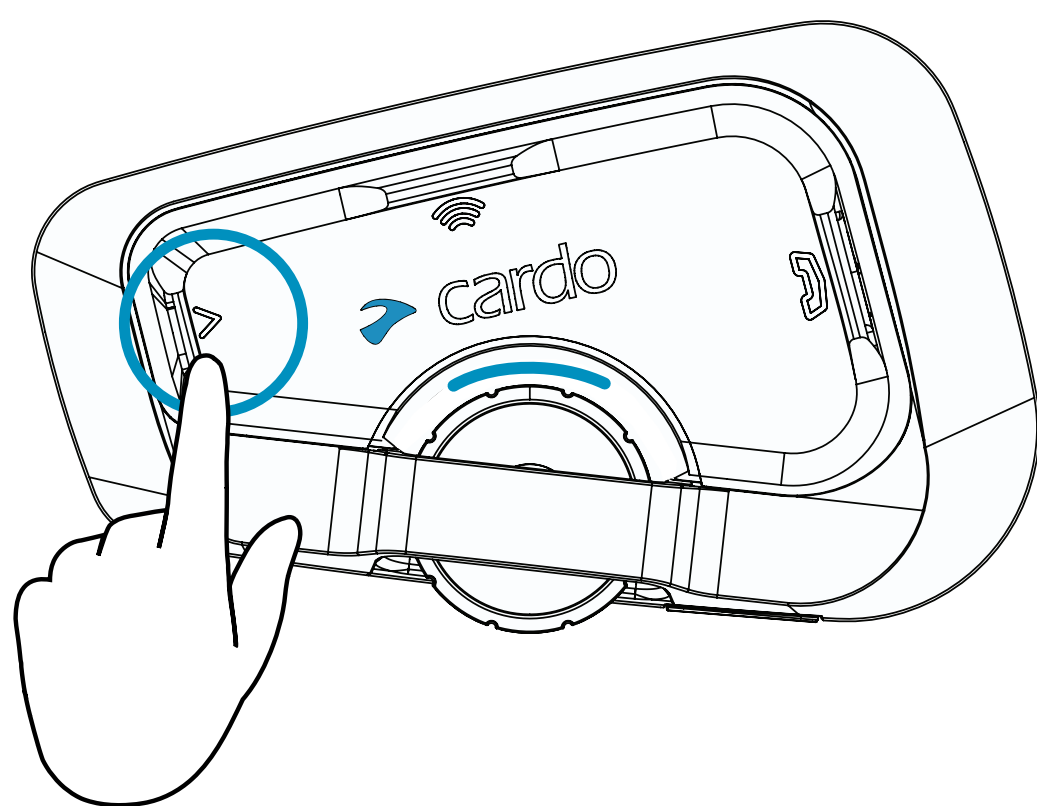



# Switch Source



Music to Radio

---

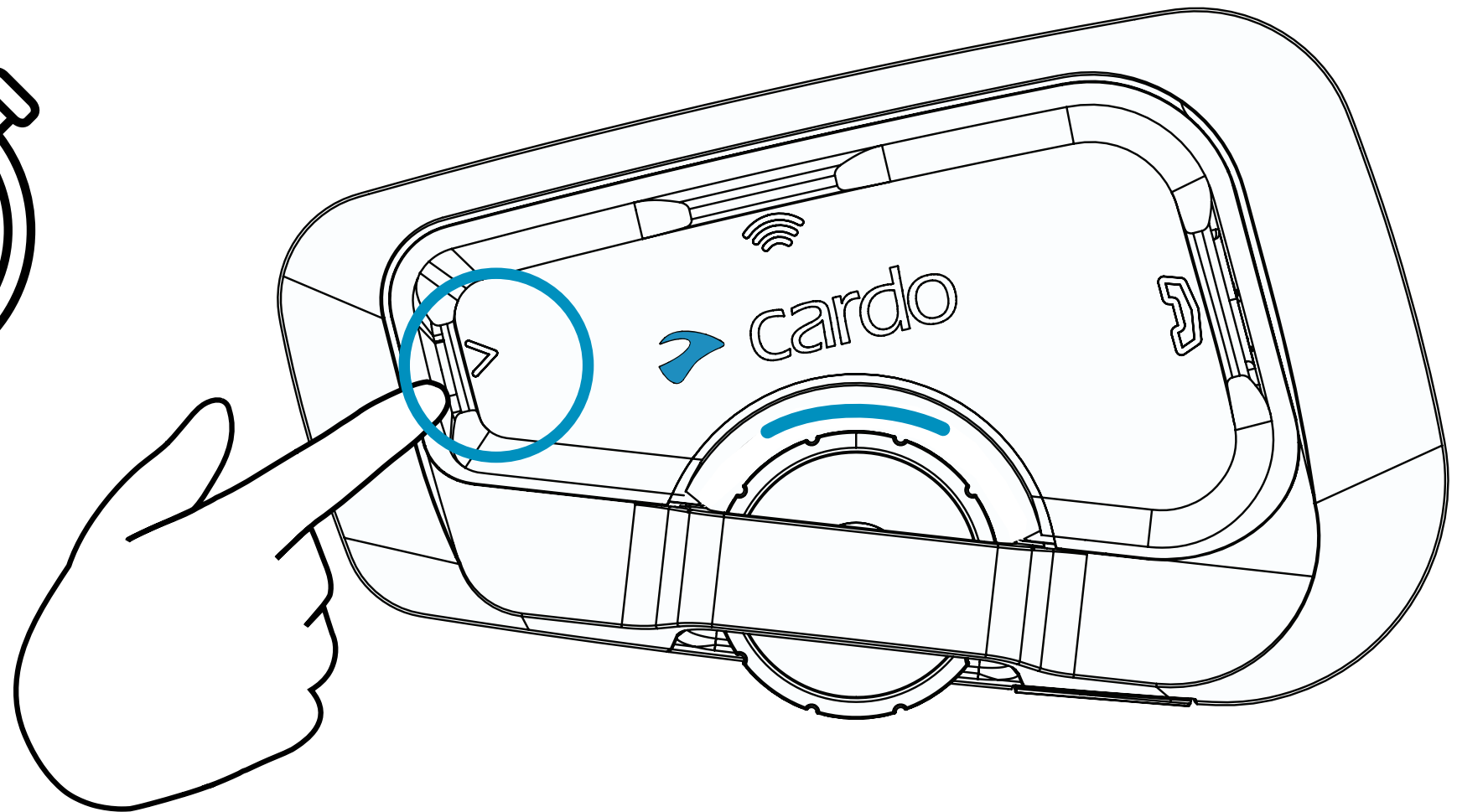

Radio to Music

---

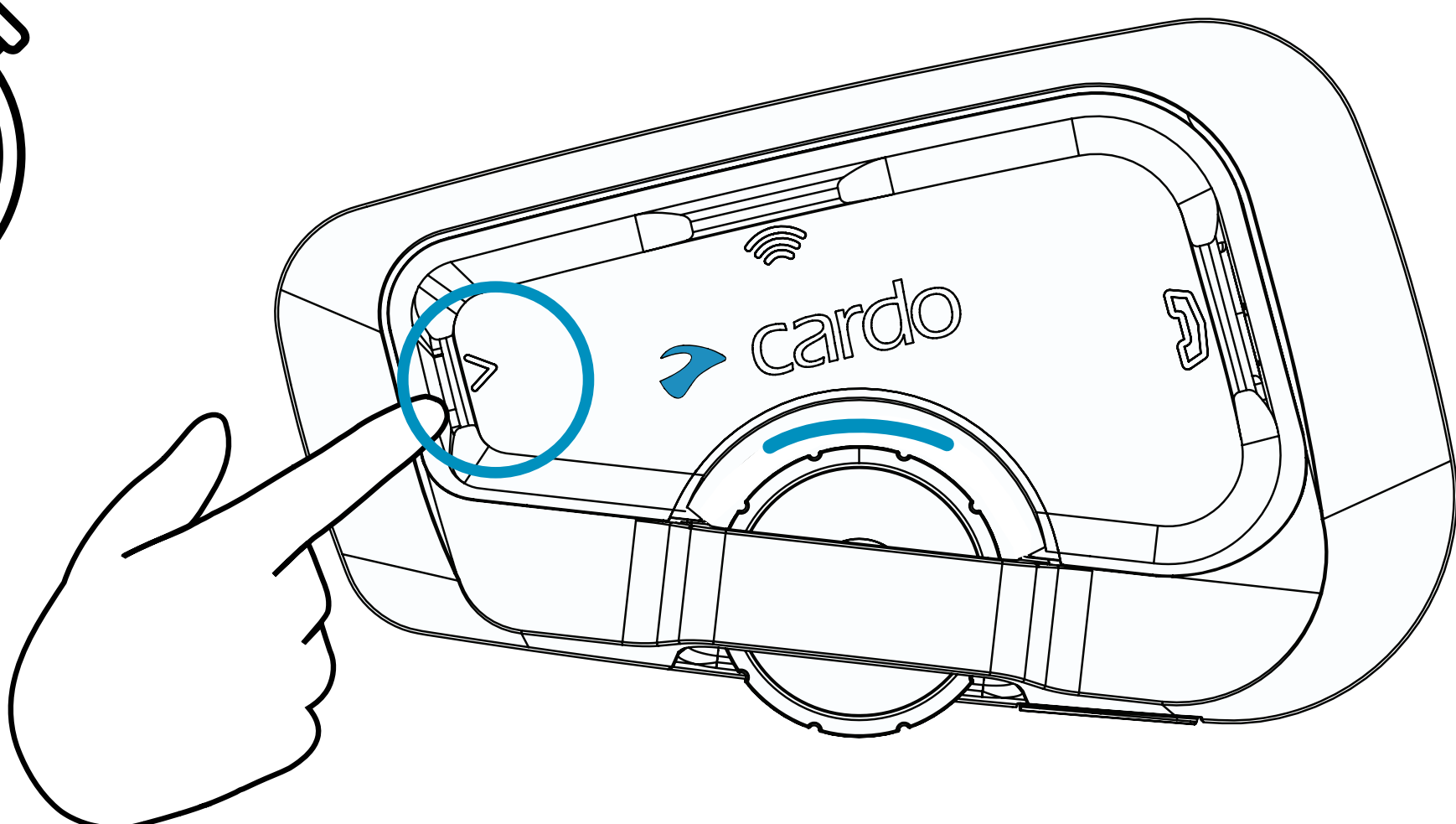
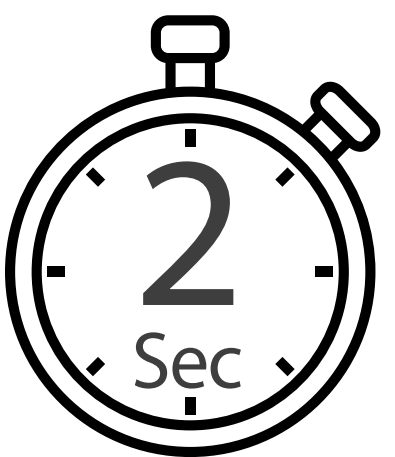

# Bluetooth Intercom



Pairing

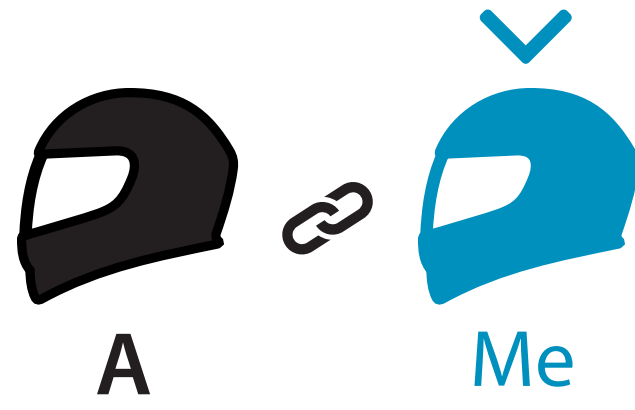

Pair to Rider A

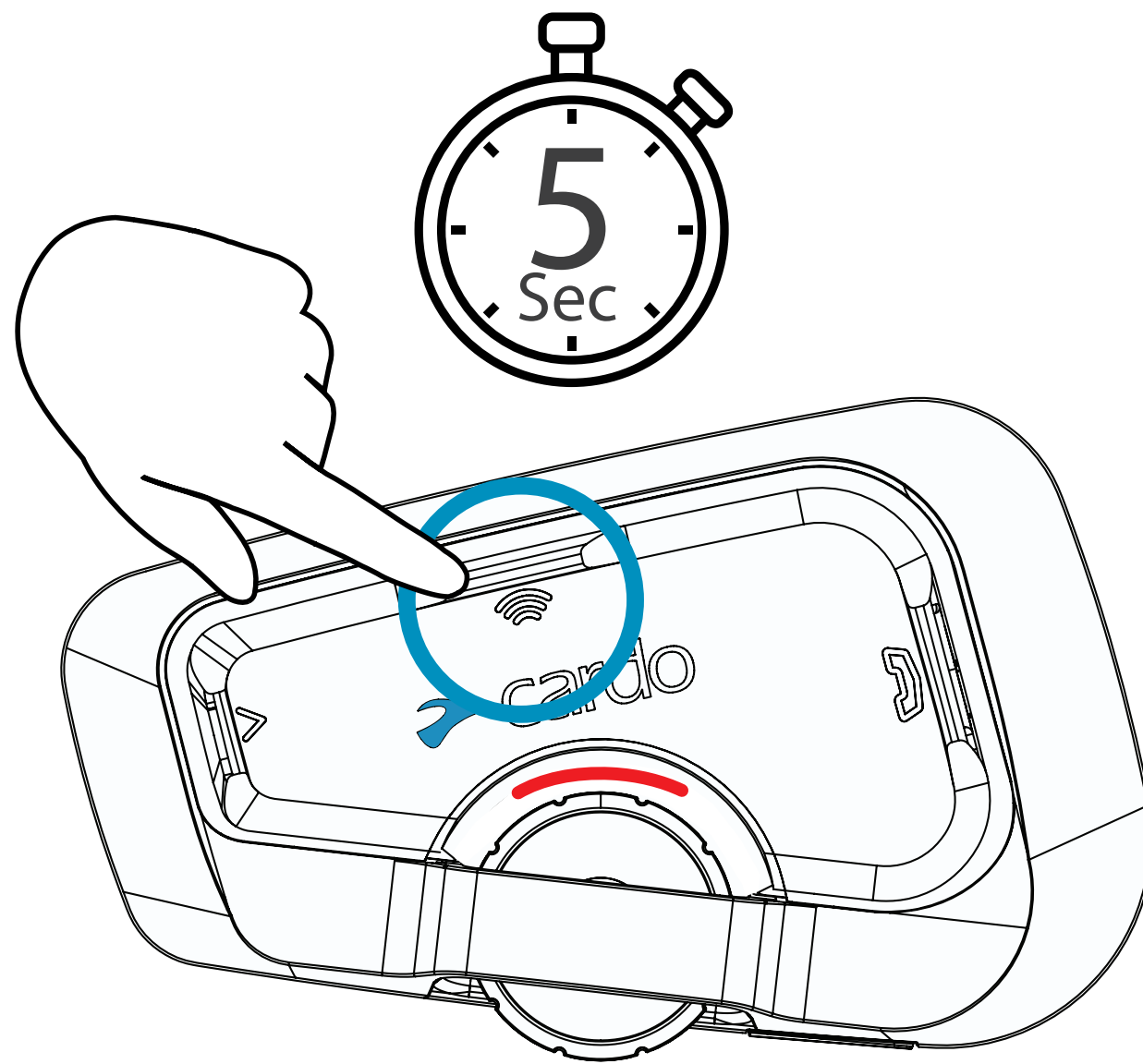

Call / End Intercom

Rider A

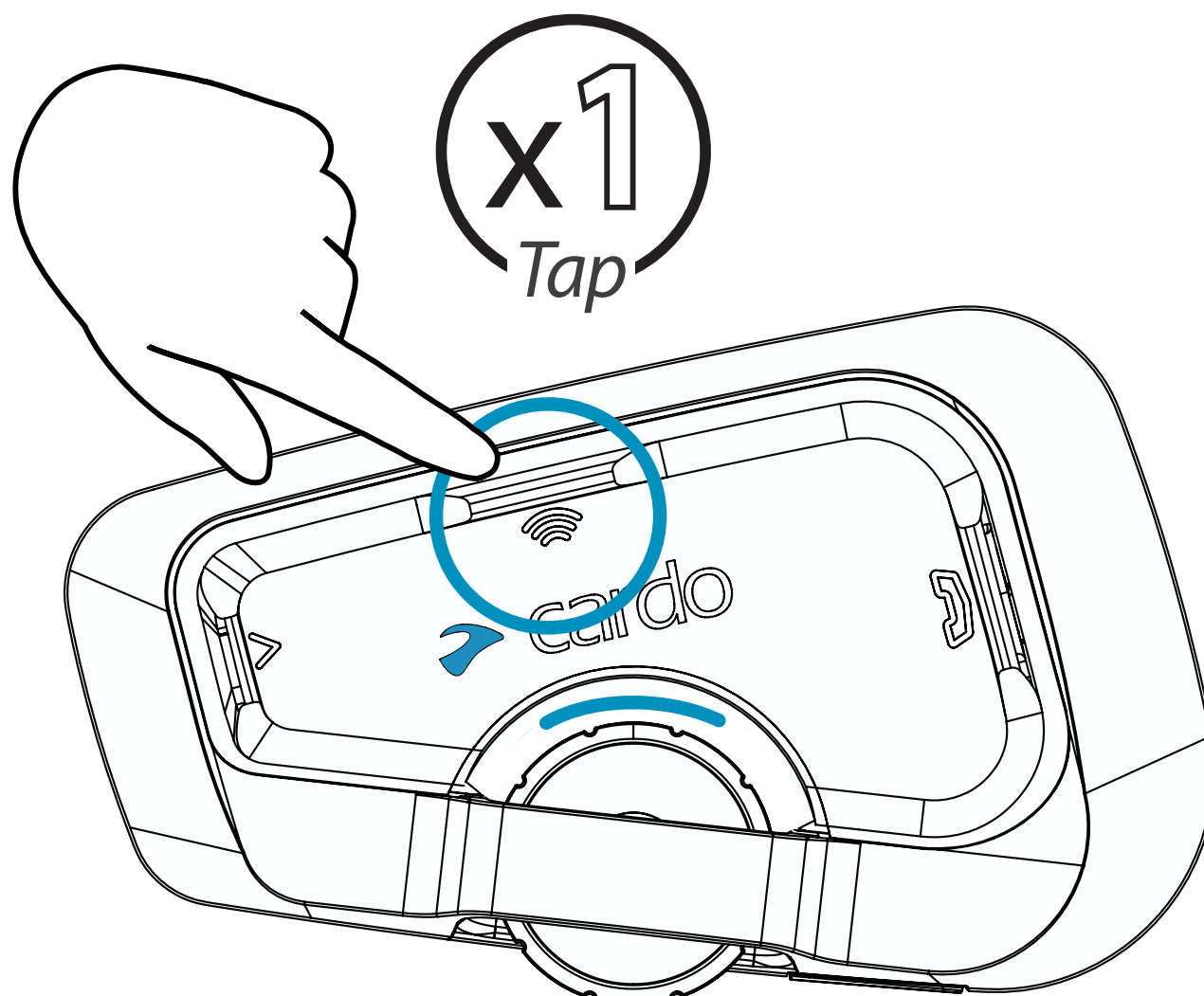



# Bluetooth Intercom

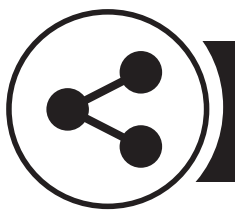

Share



Share Music

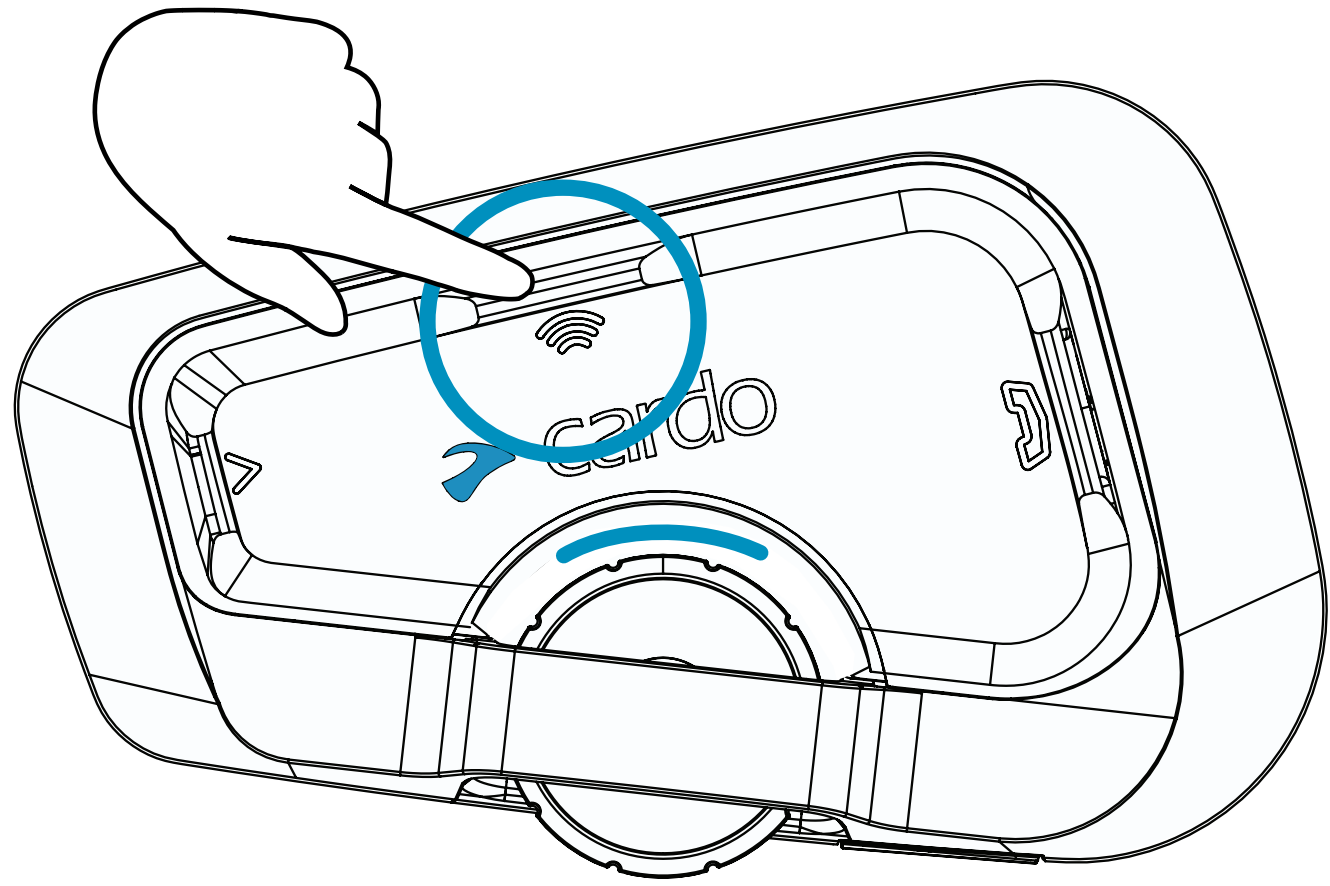

Share Phone Call

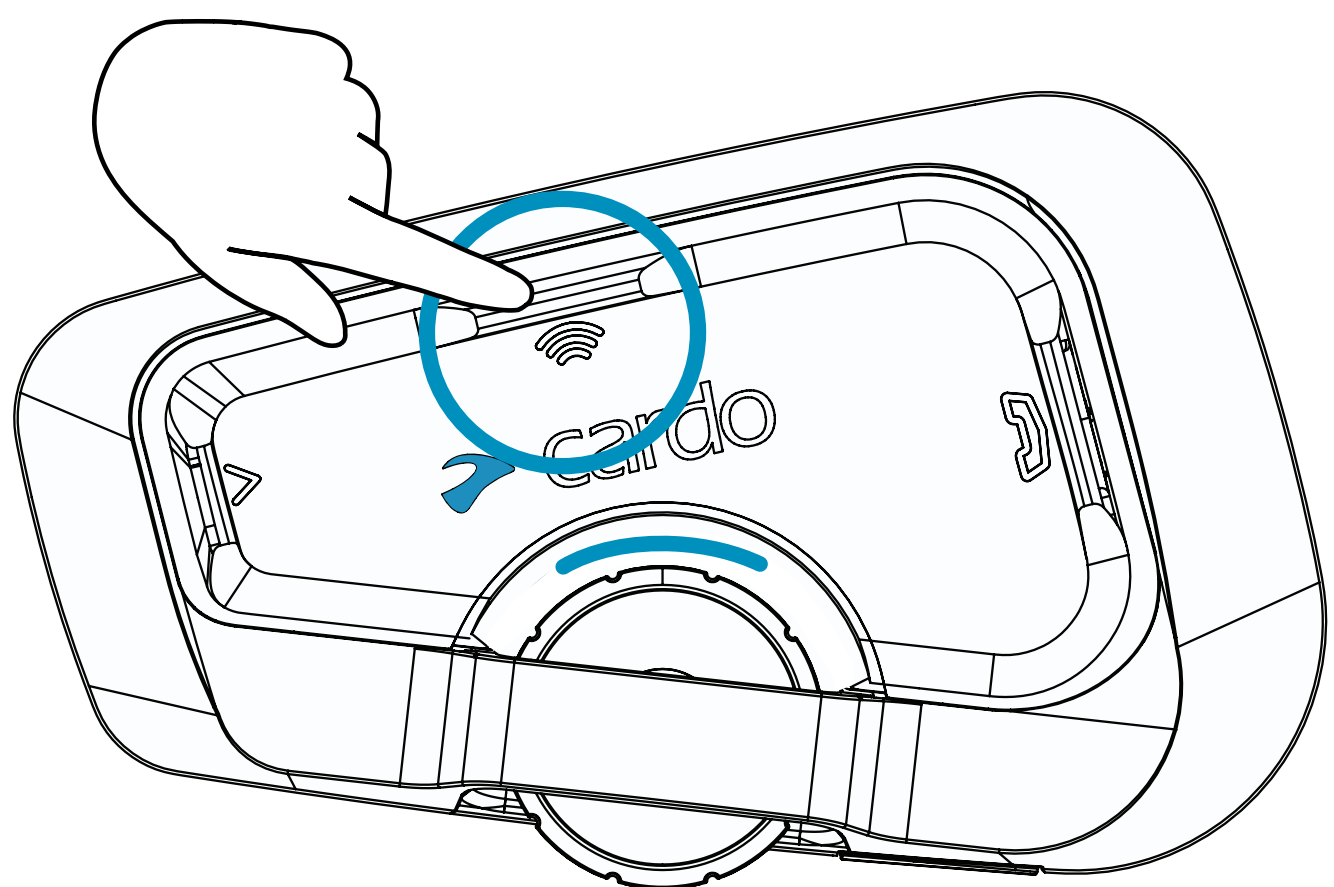

# GPS Pairing

## 1 Step 1

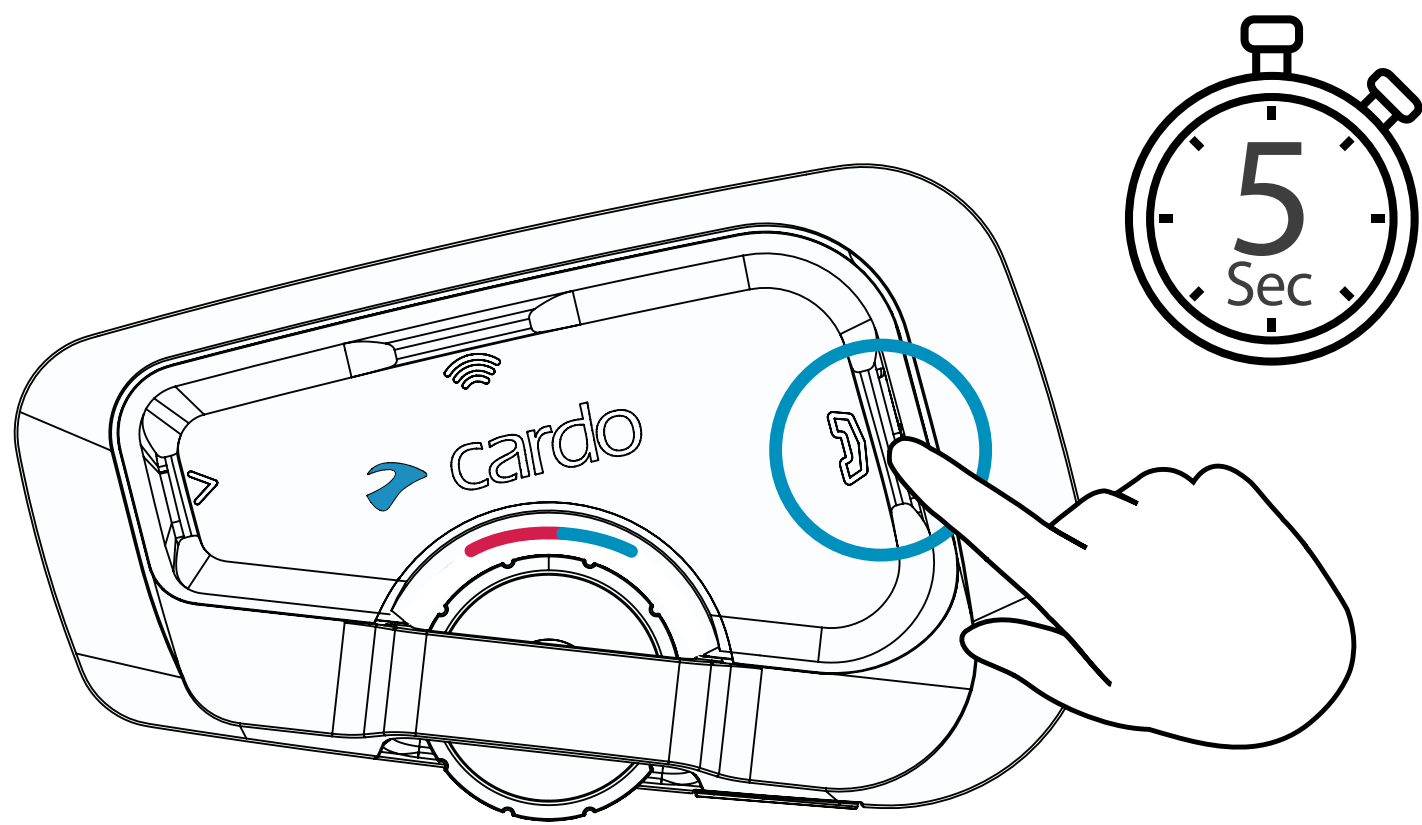

LED Red & Blue



## 2 Step 2

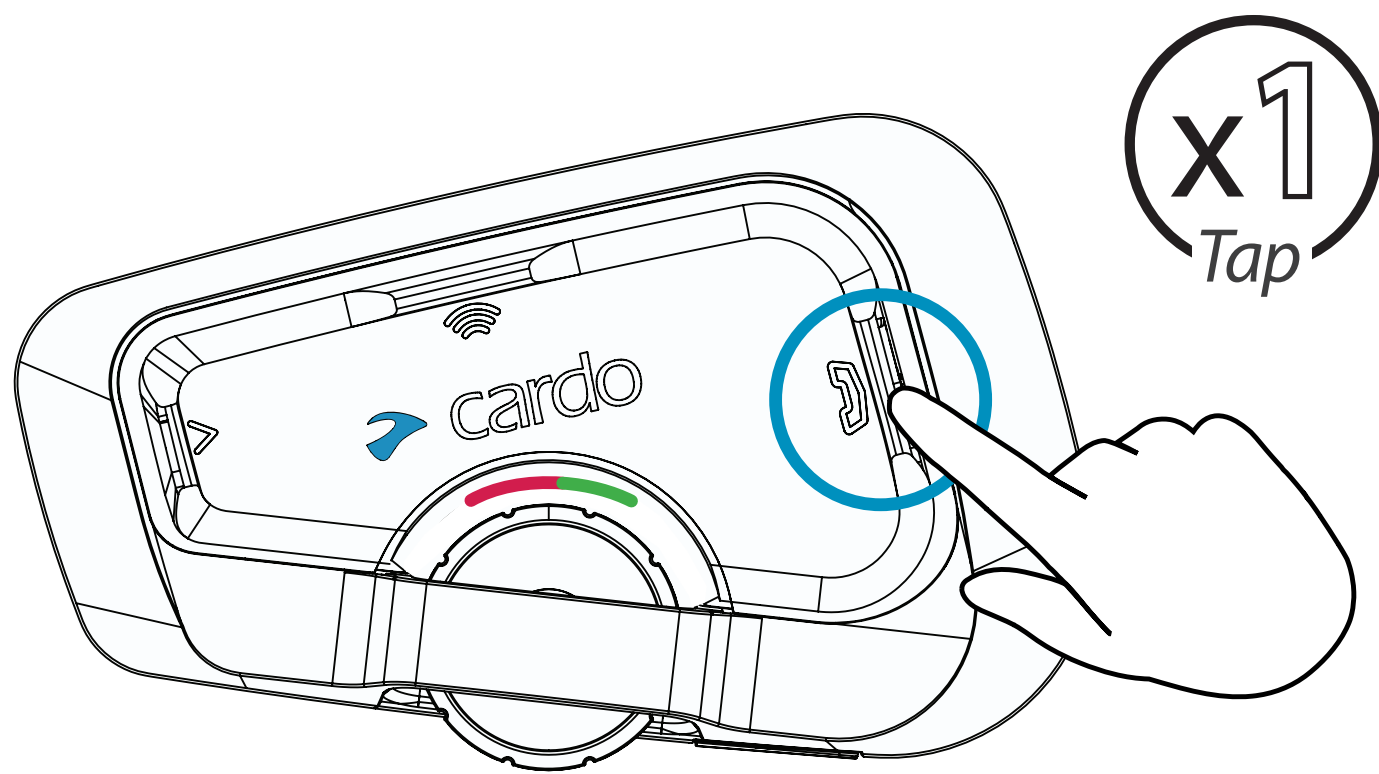

LED Red & Green



## 3 Step 3

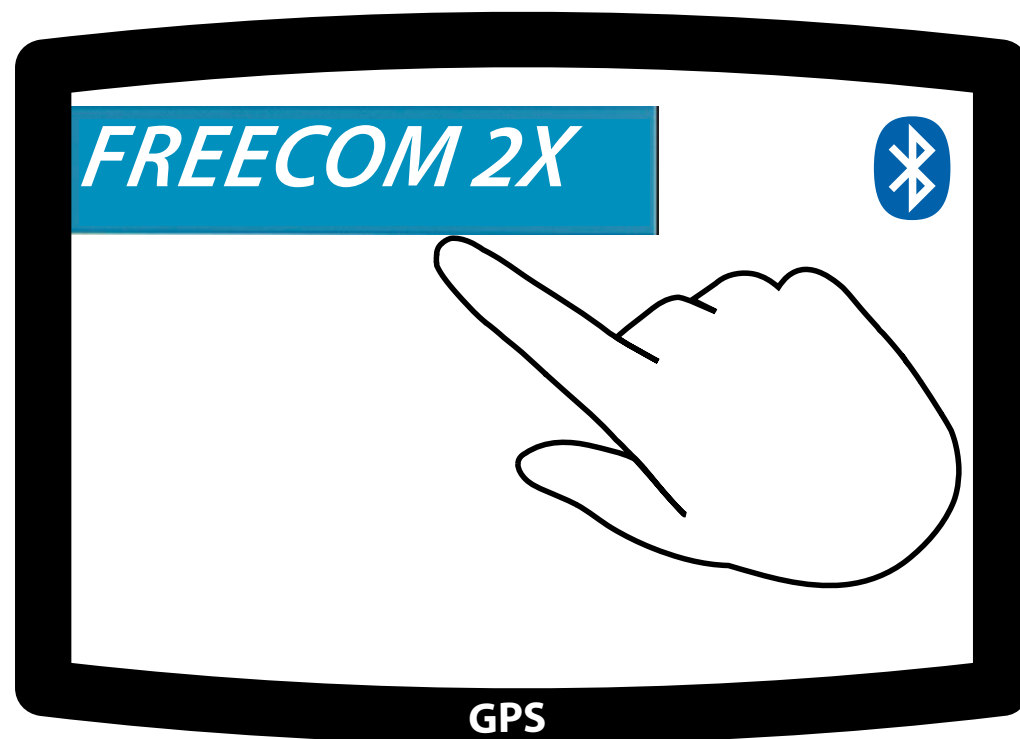



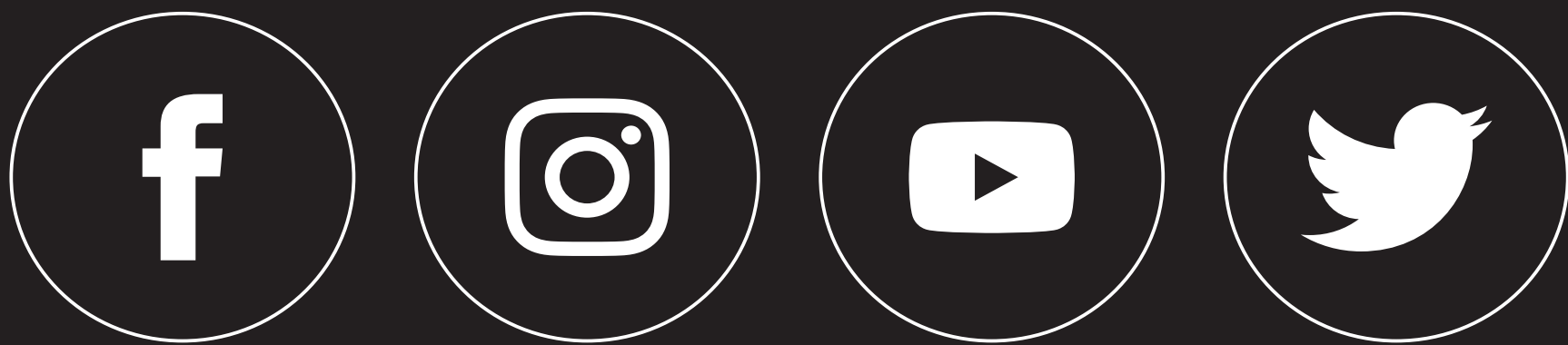

[Cardosystems.com](https://Cardosystems.com)

[Cardosystems.com/update](https://Cardosystems.com/update)

[Cardosystems.com/support](https://Cardosystems.com/support)