



PACKTALK NEO

POCKET GUIDE

EN

SOUND BY

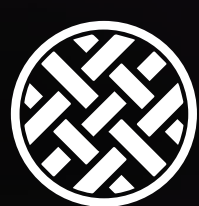

DYNAMIC
MESH
COMMUNICATION



OPERATED BY
NATURAL VOICE



cardo®

CONNECT APP

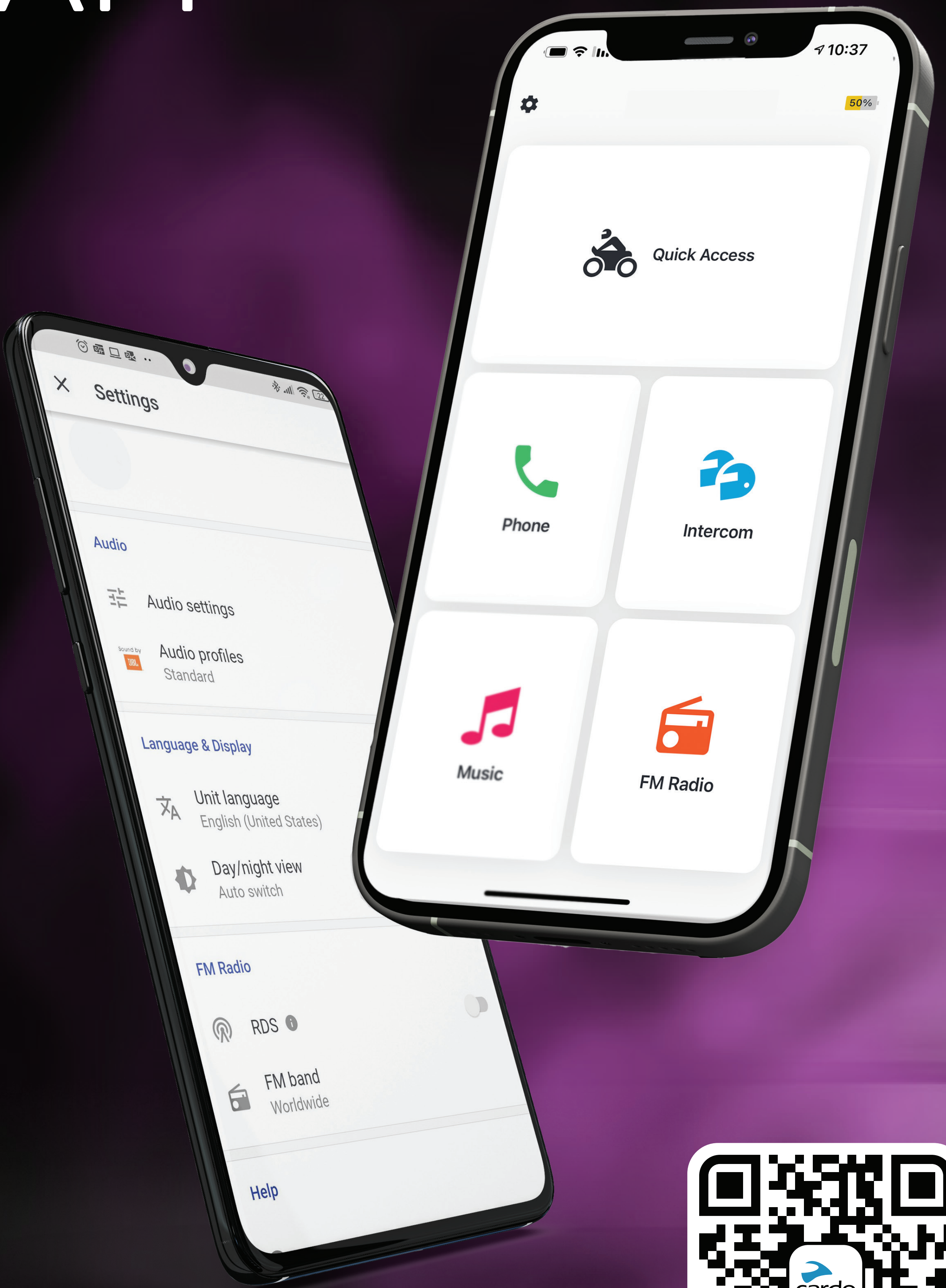

Cardo Connect App

Table of Contents

4-5

Getting Started

6

Cardo Connect App

7

General

8-9

Radio

10

Music

11

Switch Source

12

Phone Call

13

DMC Intercom

Advanced Features

14

Music Sharing

15

DMC Intercom

16

Phone Call

17

GPS Pairing

18

Universal Bluetooth intercom

19

Reboot

20

Voice Commands - Always On!

Getting Started

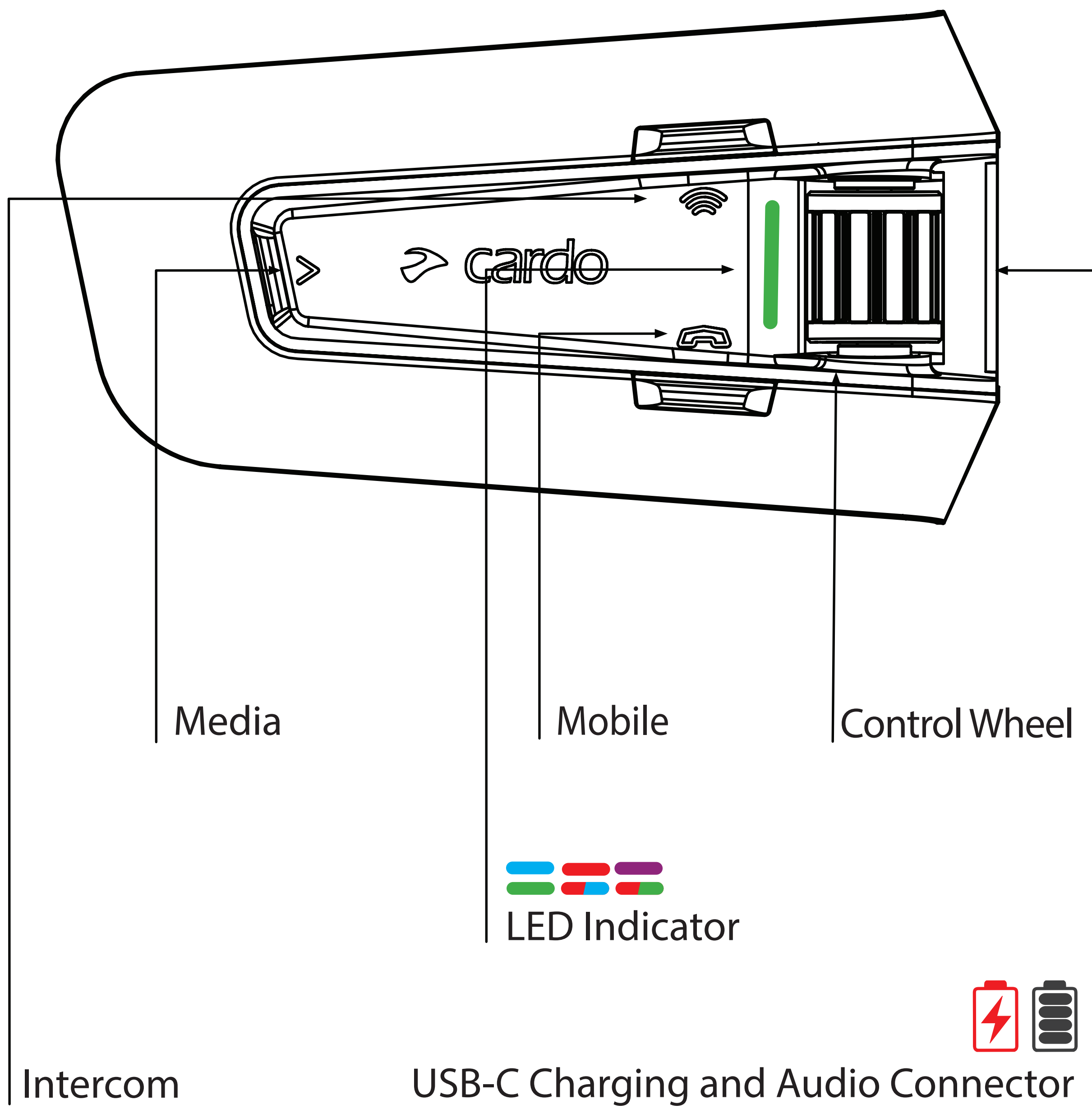

Press & Hold



Number of Taps

Getting Started

On / Off

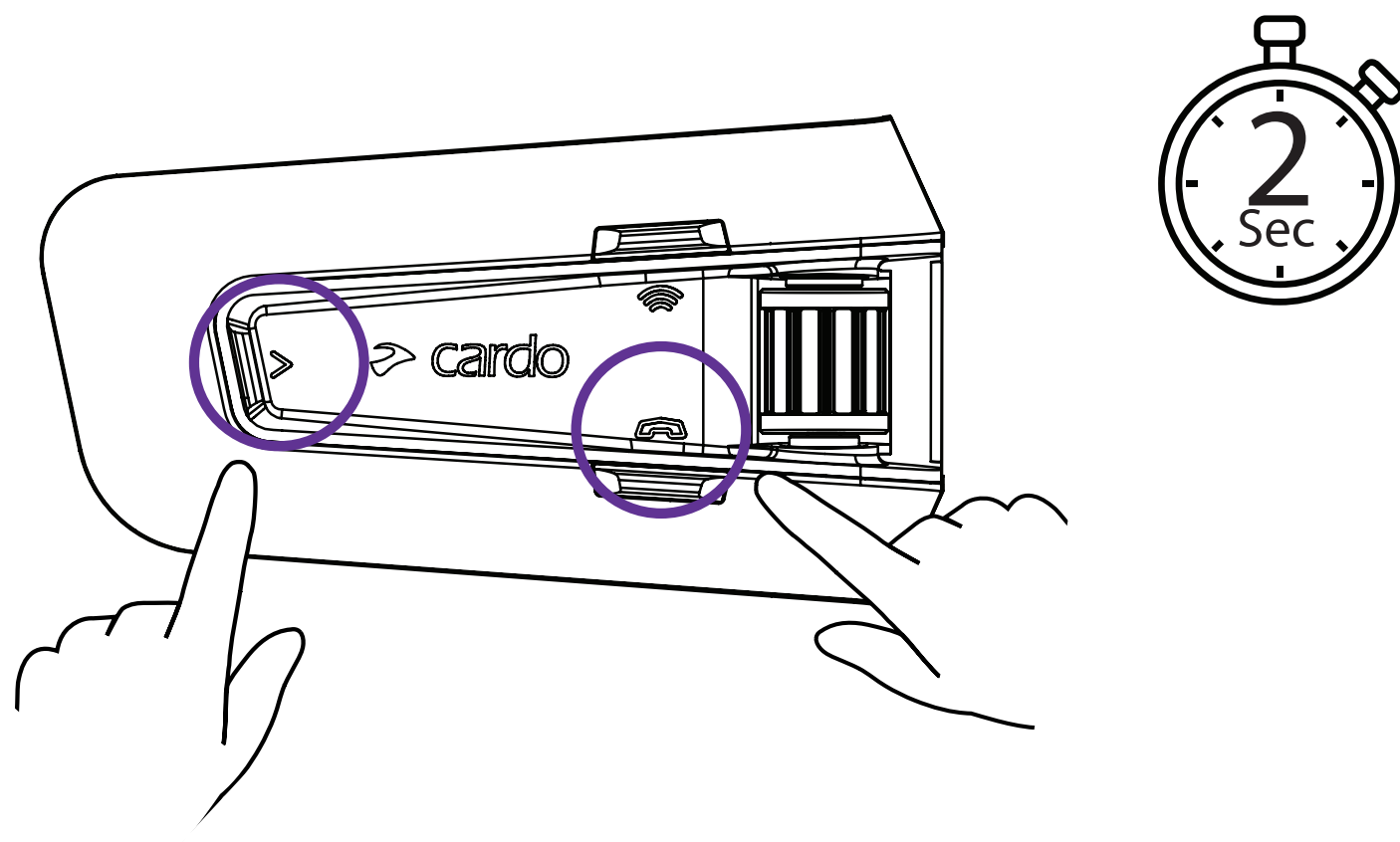

Phone Pairing

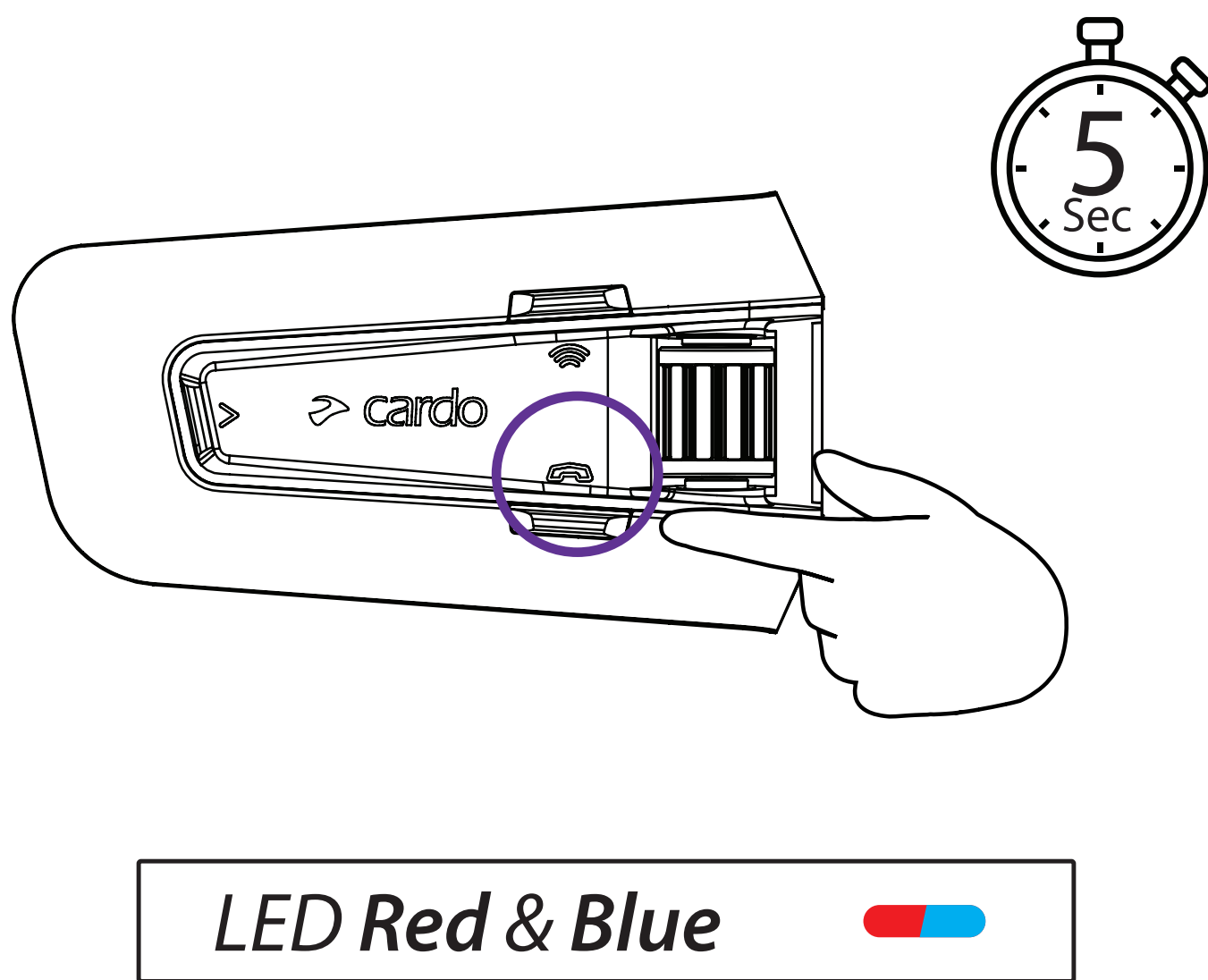

LED Red & Blue 





Cardo Connect App



Download



Register

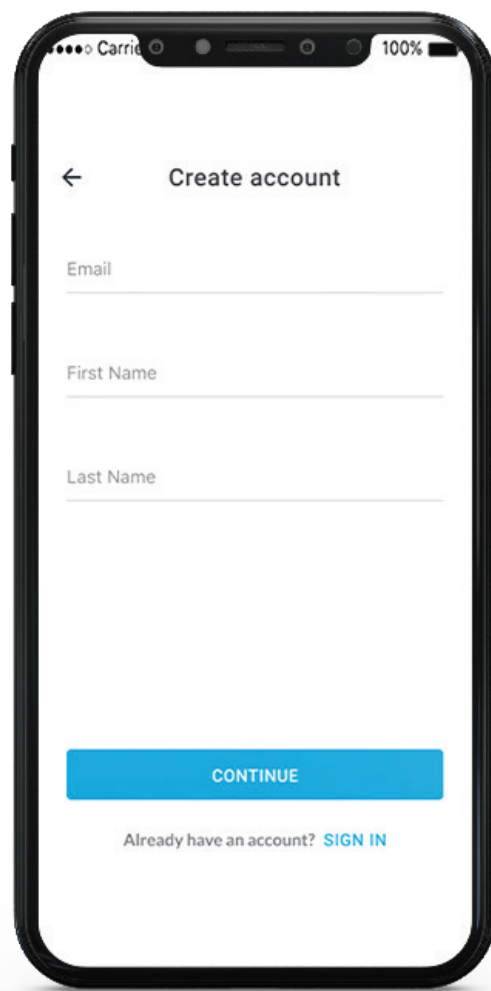

Choose Language

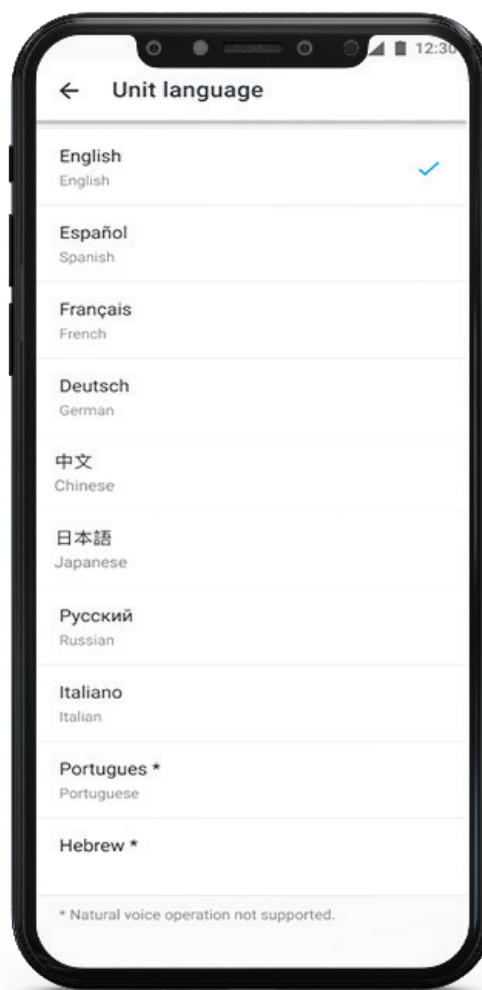

Update Software

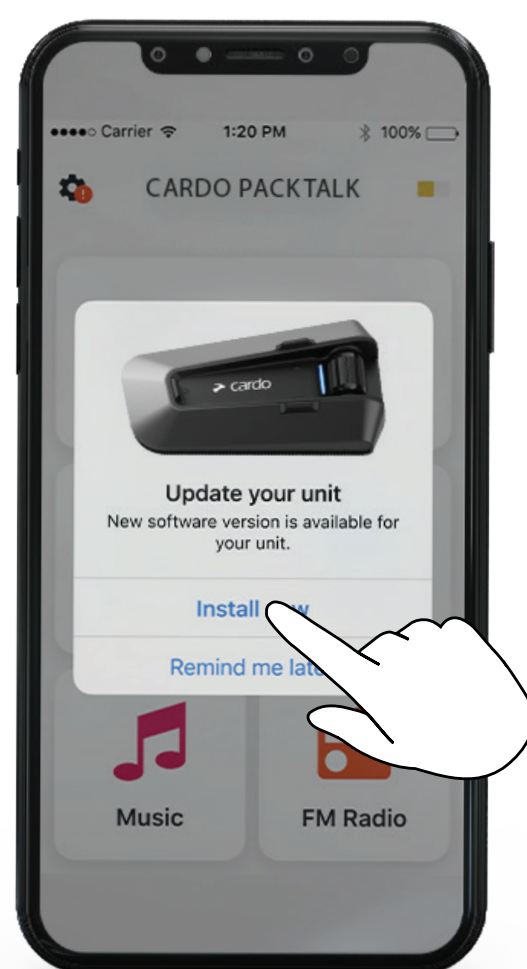

General

Volume Up

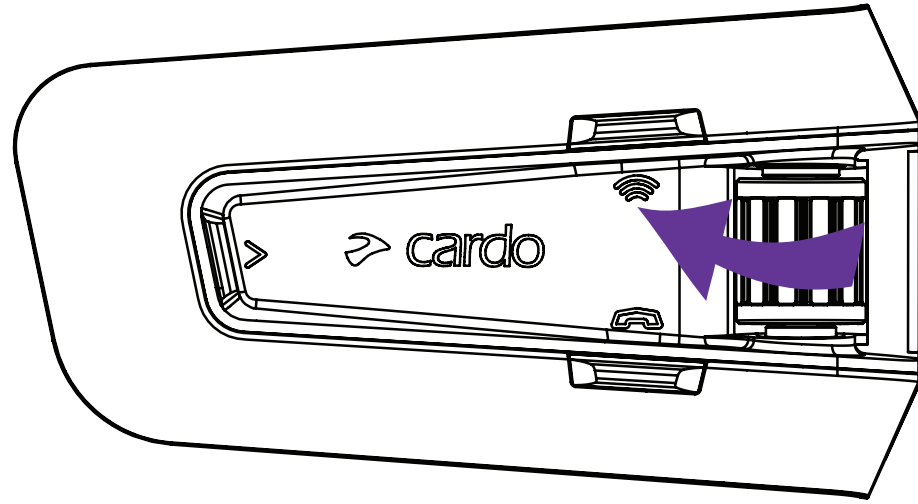

Volume Down

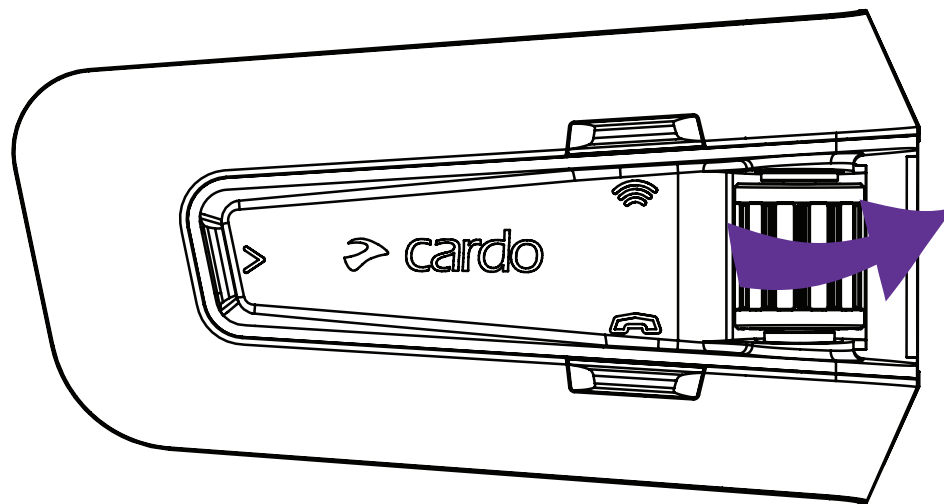

Mute / Unmute Microphone

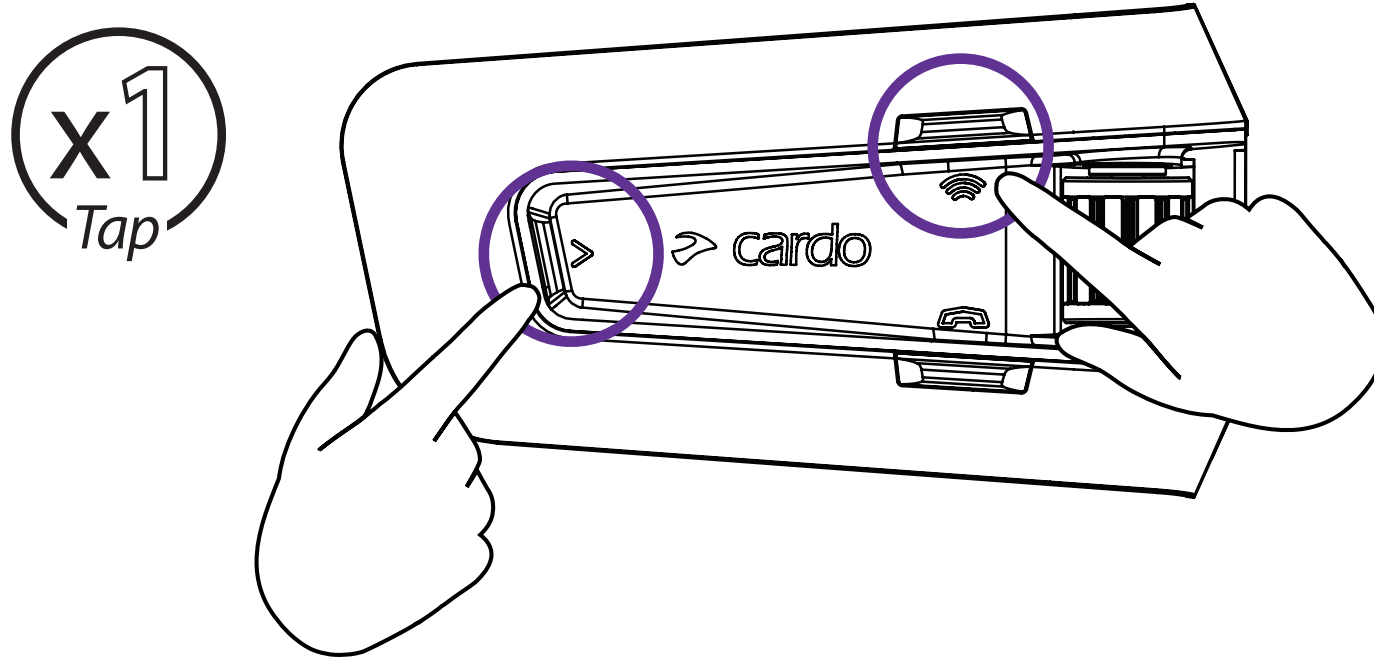

Voice Assistant



Hey Siri

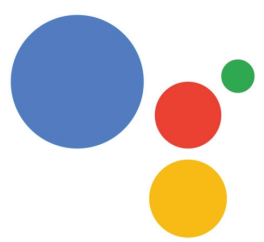

Google
Assistant

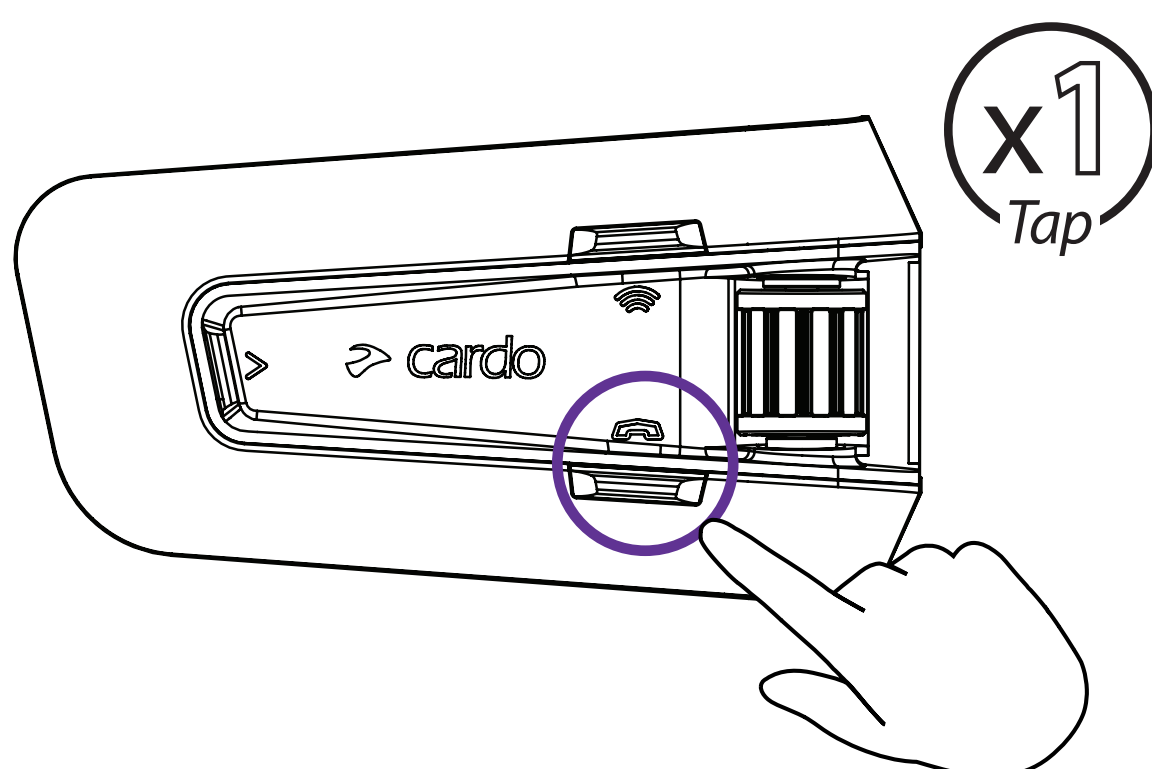

Radio

Set Presets

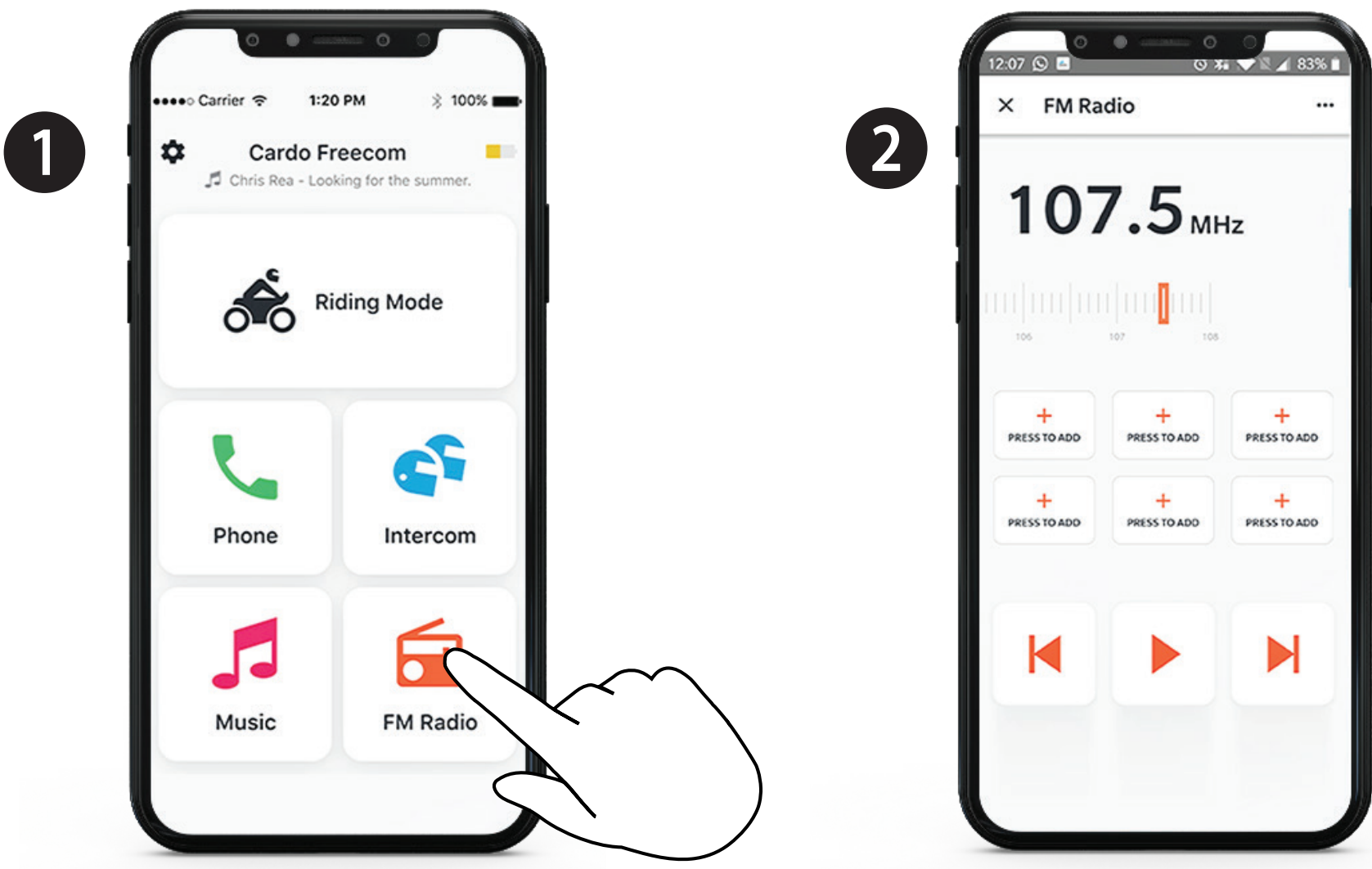

On

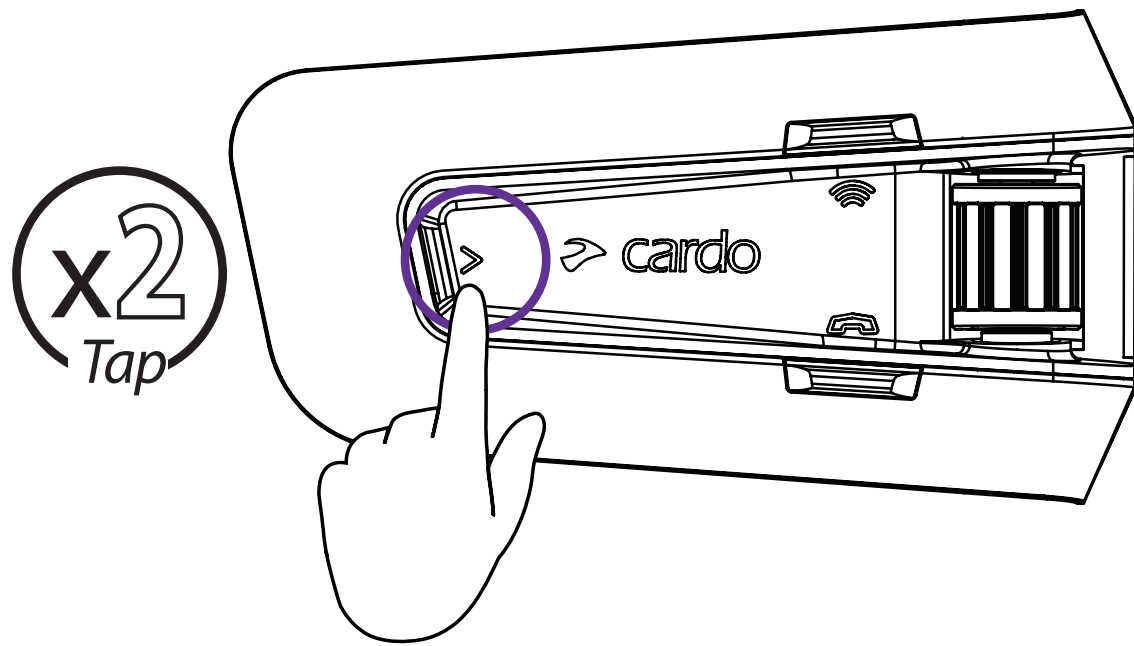

Off

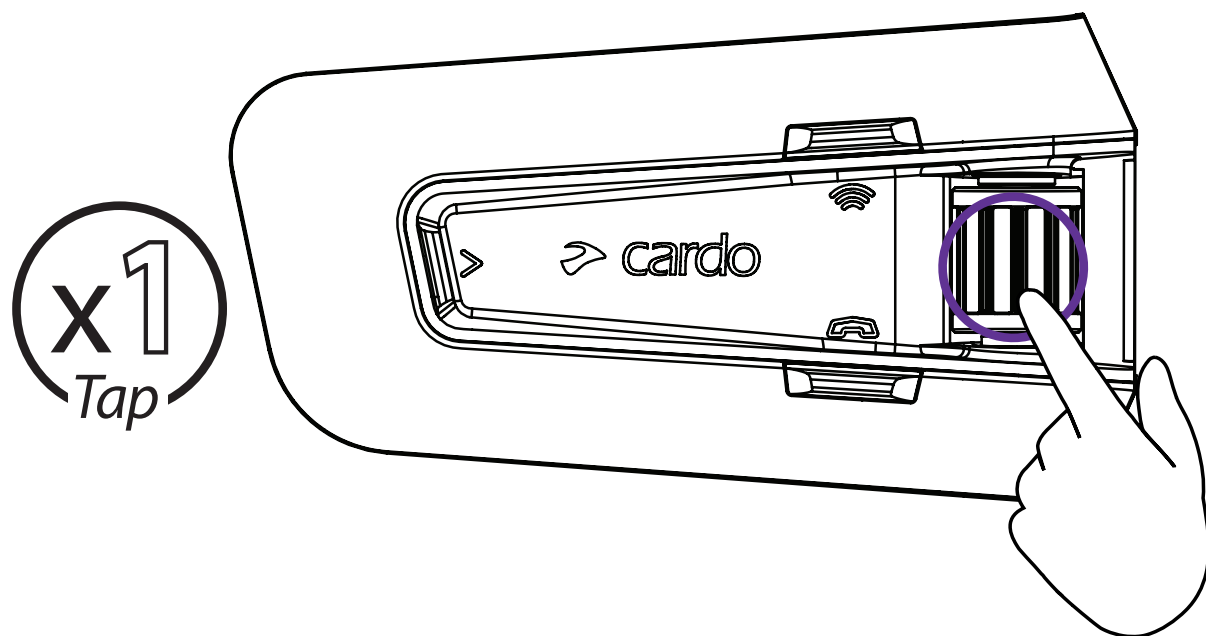

Radio

▶▶ Next Preset

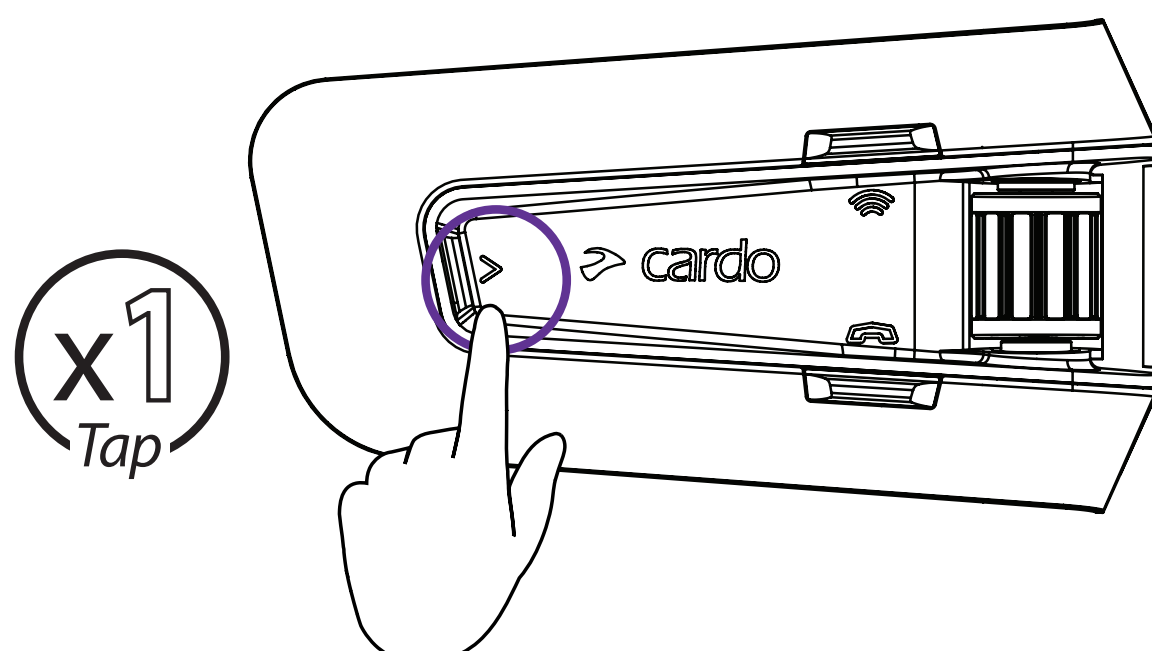

◀◀ Previous Preset

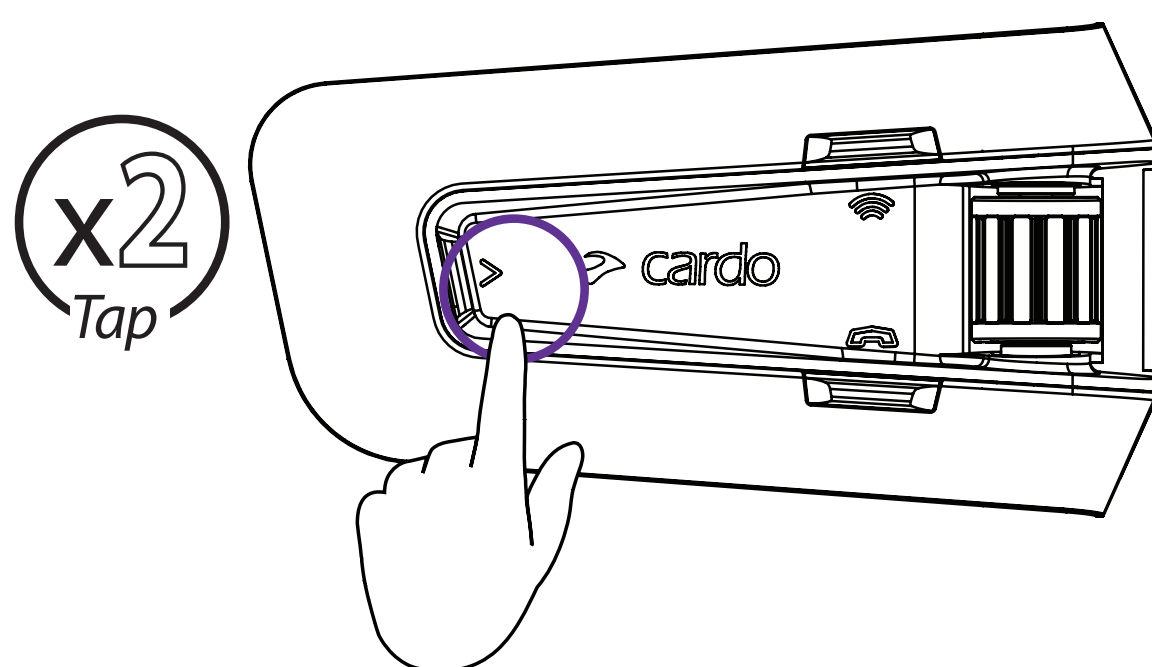

»» Start Scan

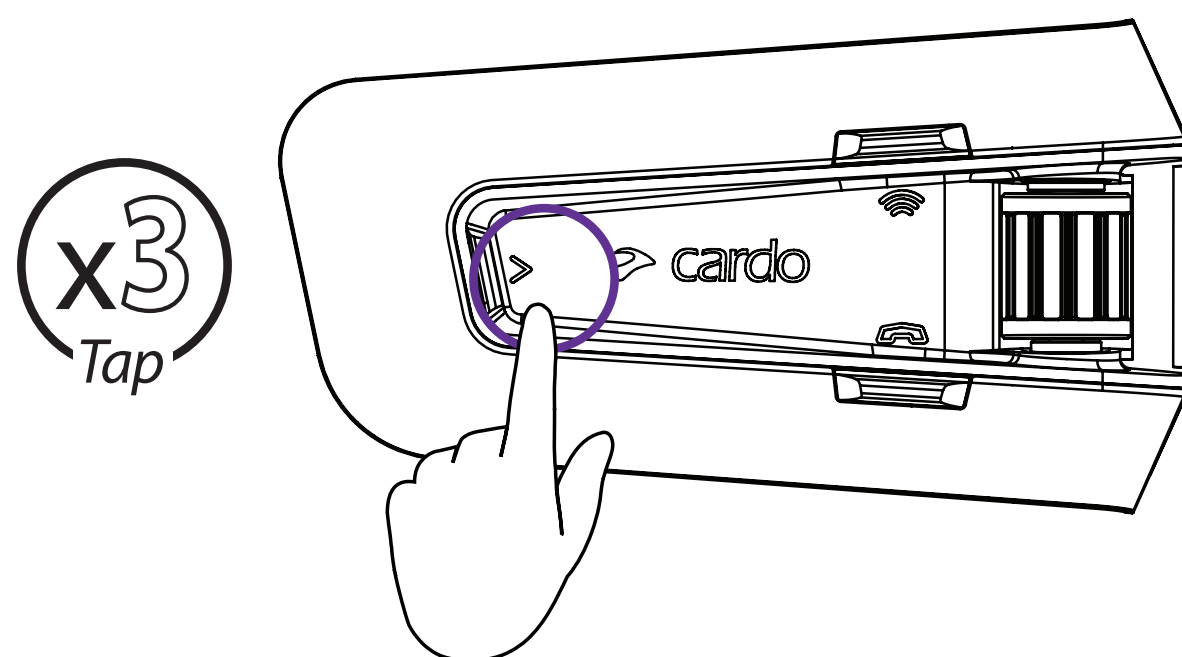

■ Stop Scan

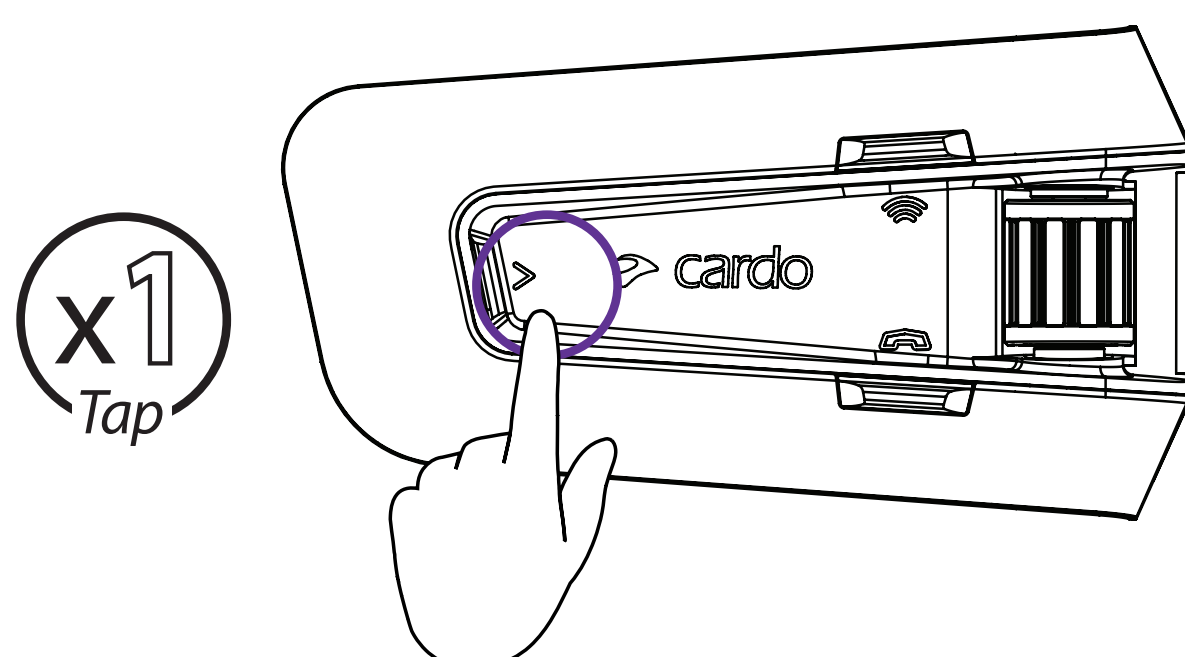

Music

▶ On

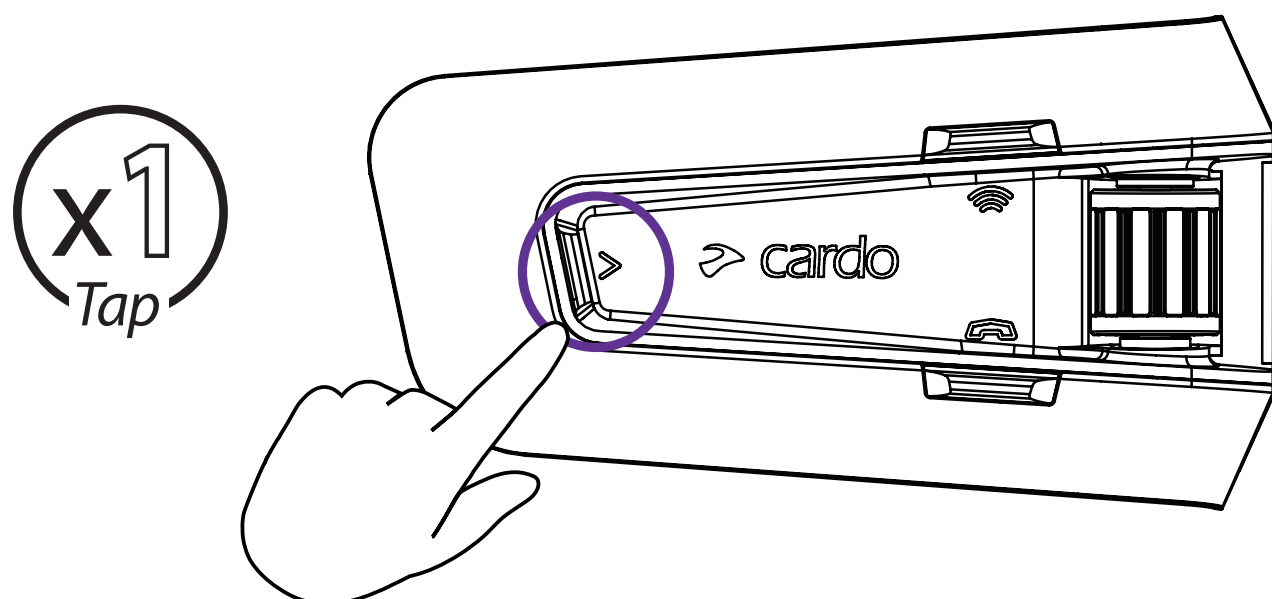

⏸ Off

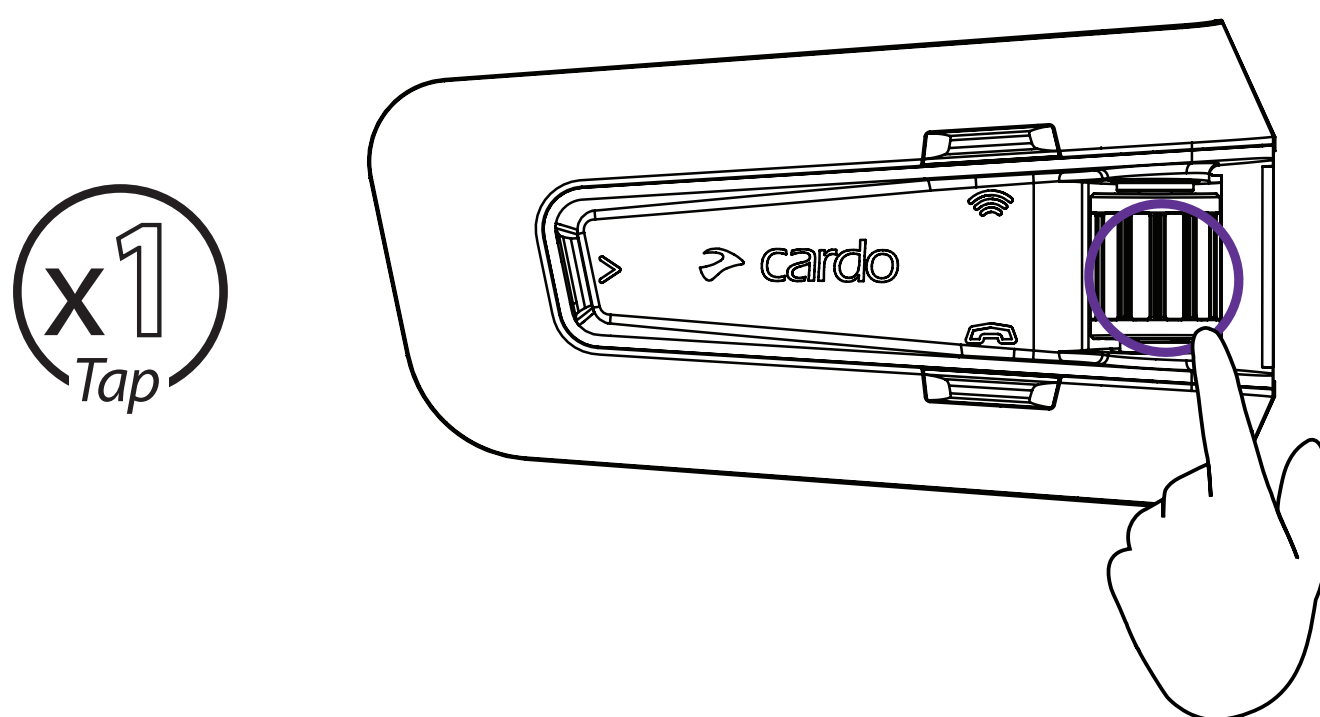

▶ Next

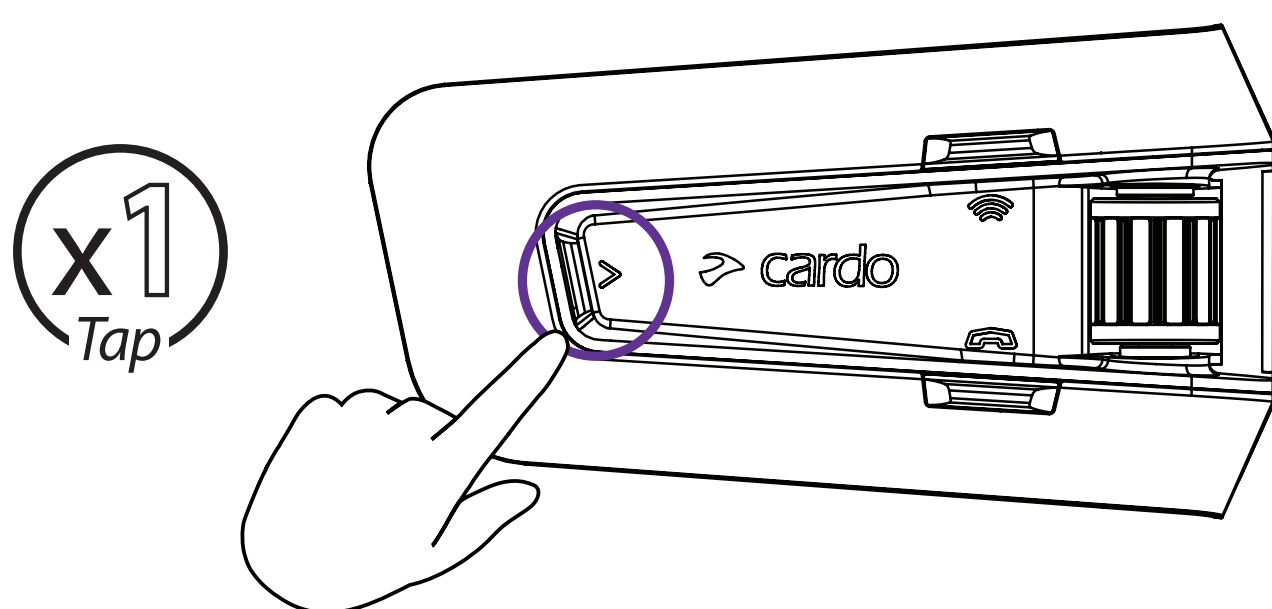

◀ Previous

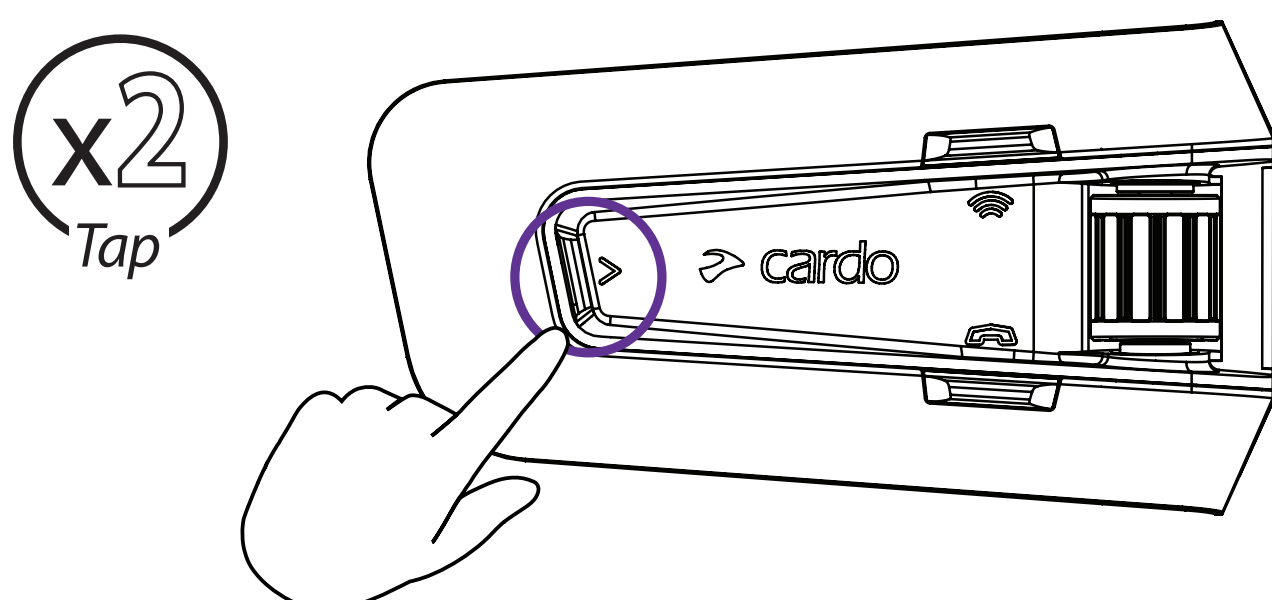

Switch Source

Music to Radio

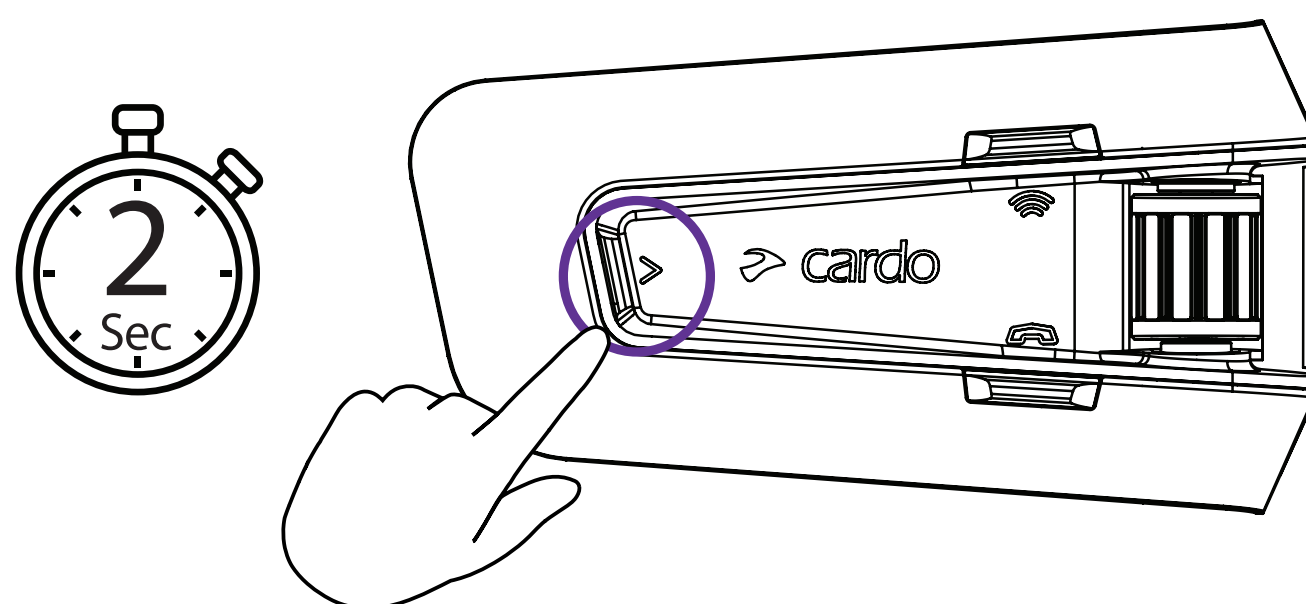

Radio to Music

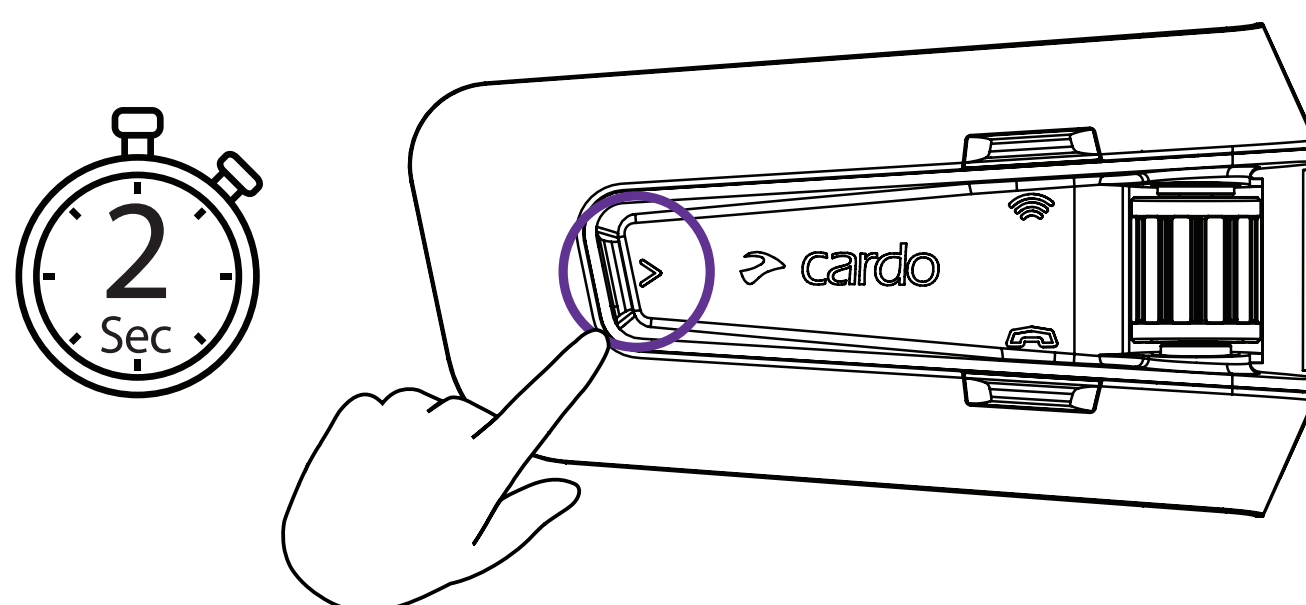

Phone Call

 Answer

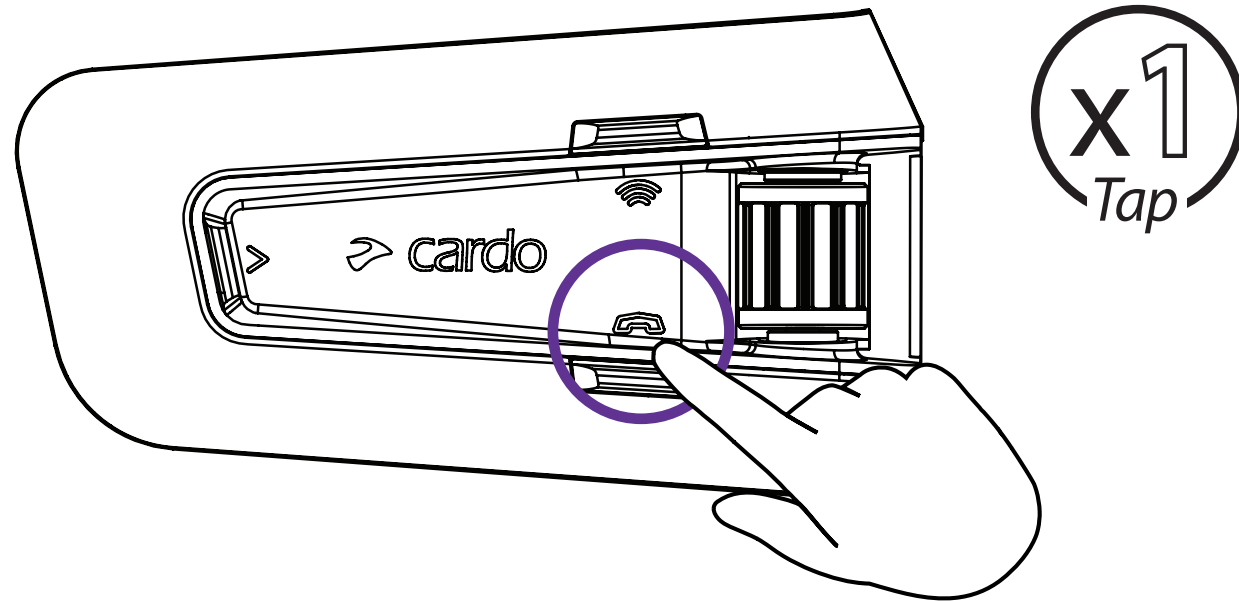

 Ignore

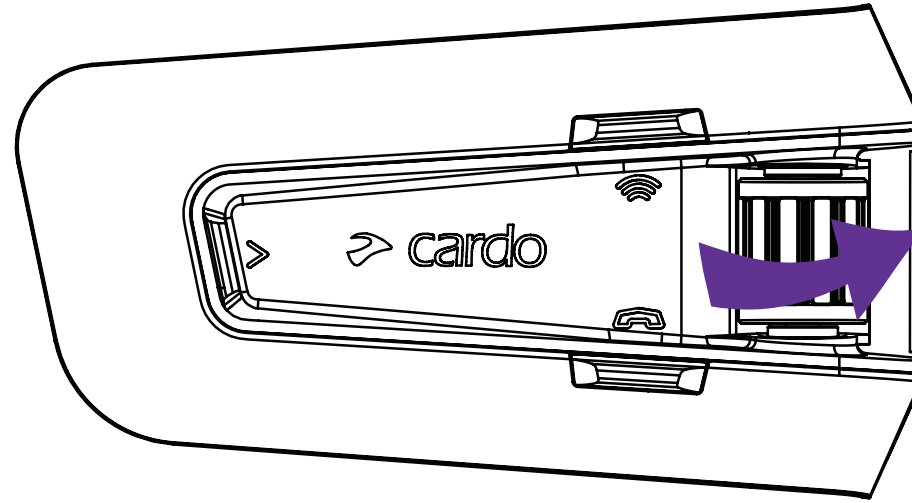

 End Call

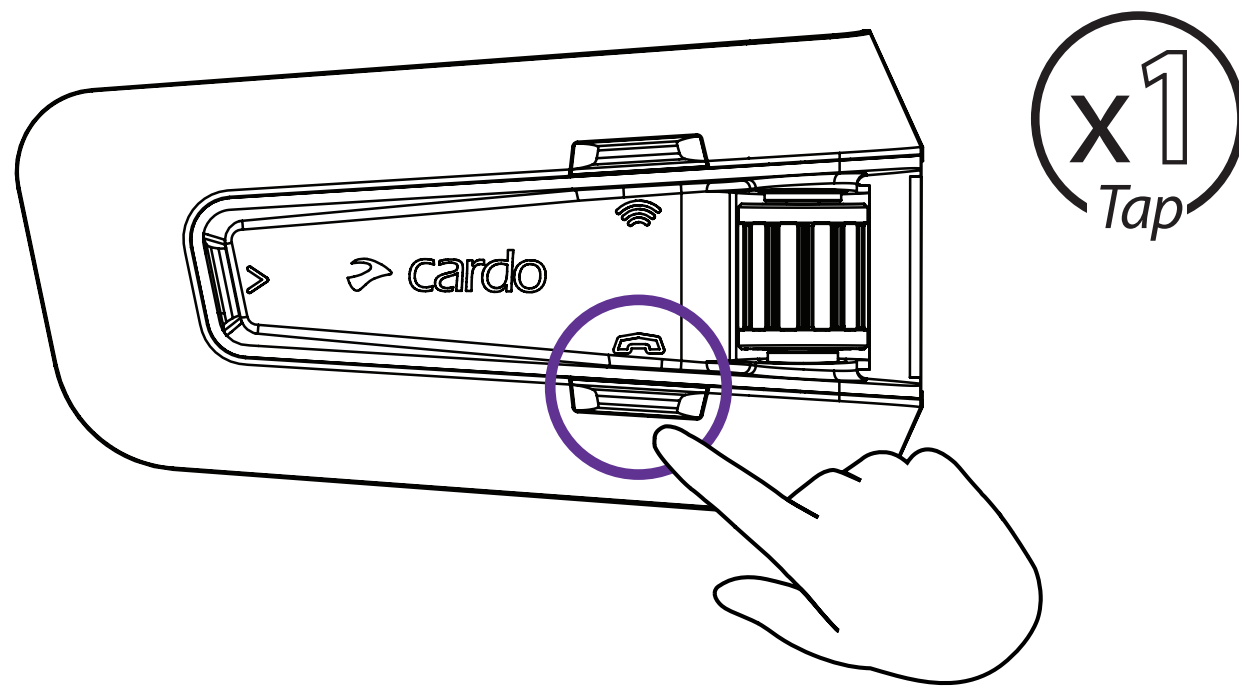

 Redial

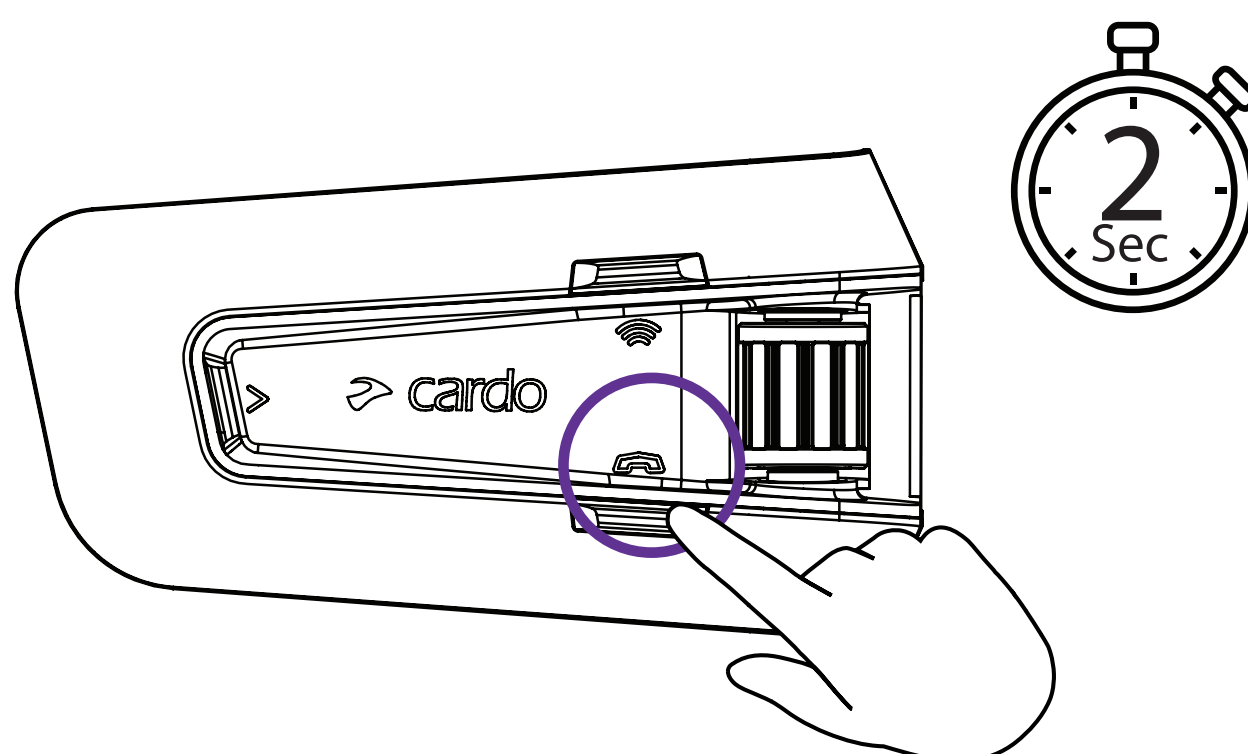

DMC Intercom

Grouping

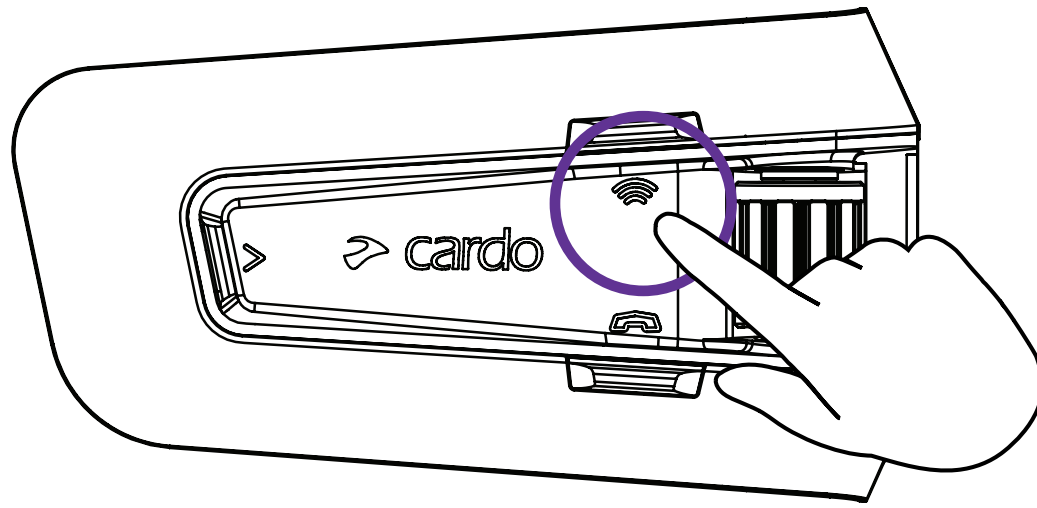

LED Red & Green 

Grouping Success

LED Purple 

Mute / Unmute Group

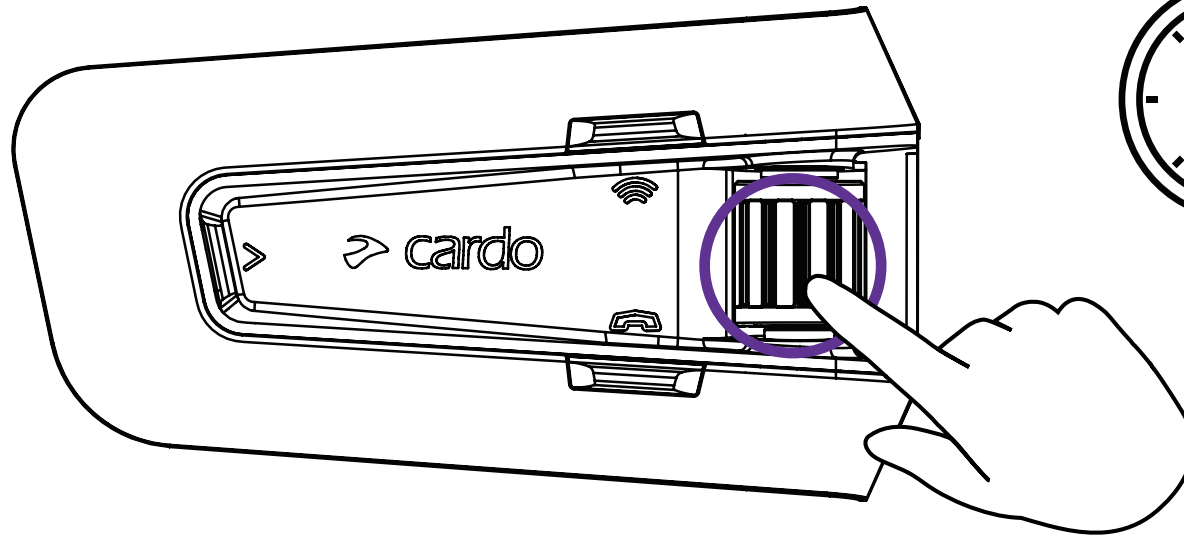

Share Call

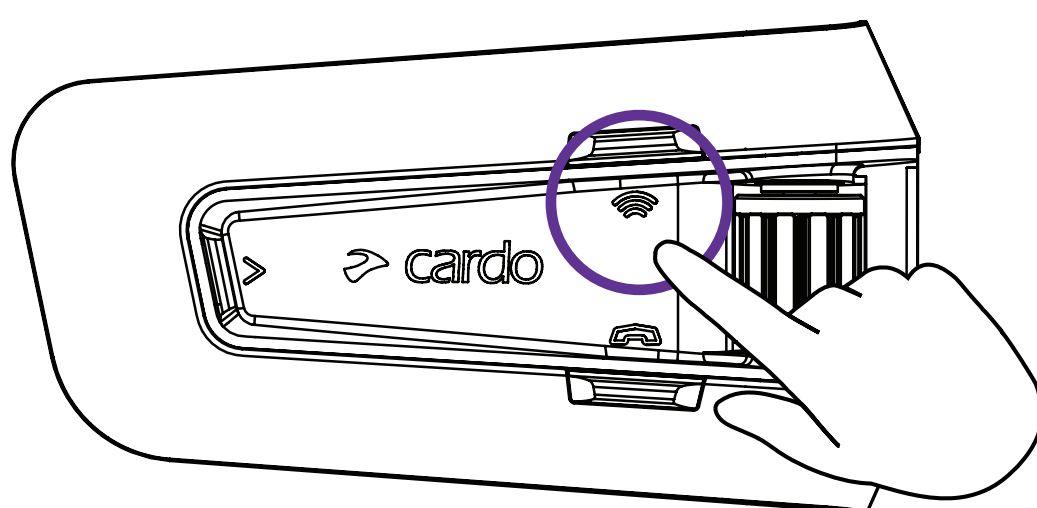

Advanced Features

Music Sharing

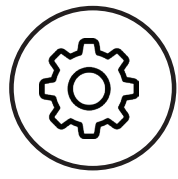

Set Sharing Partner

1

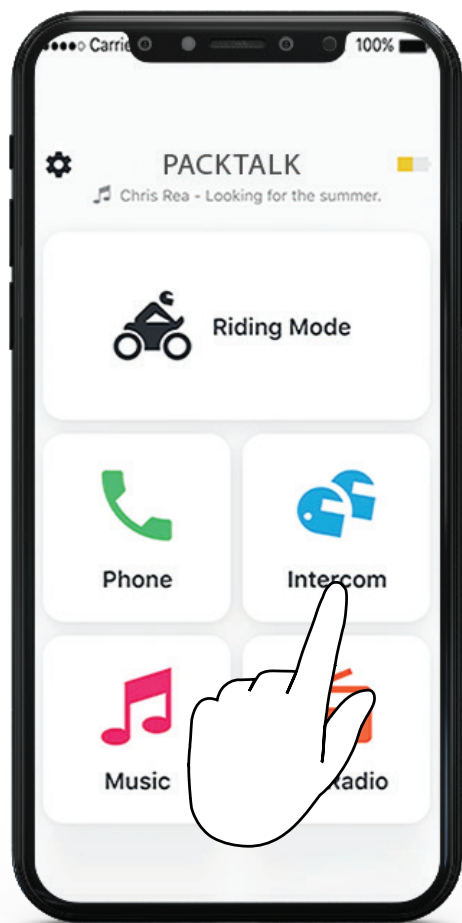

2

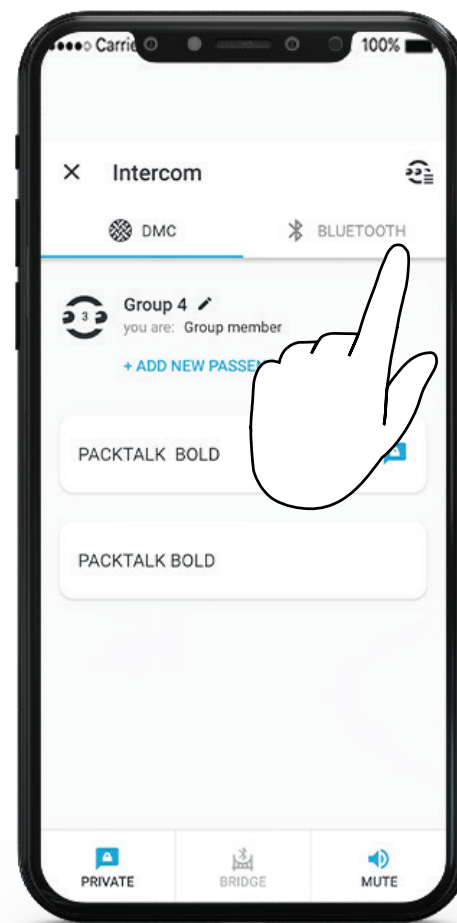

3

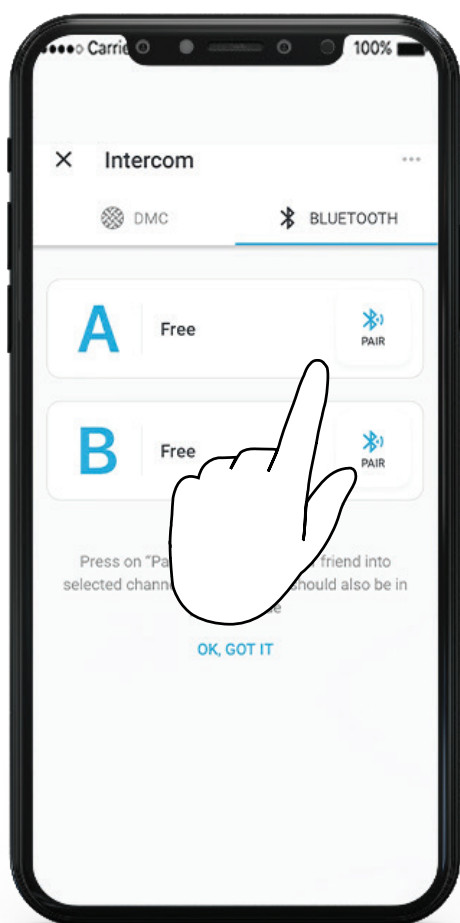

4

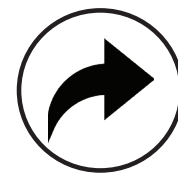
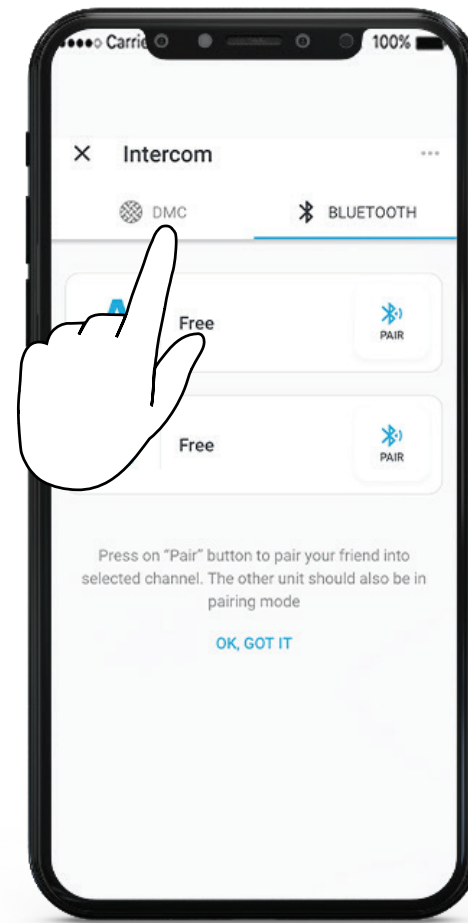

Start / Stop Sharing

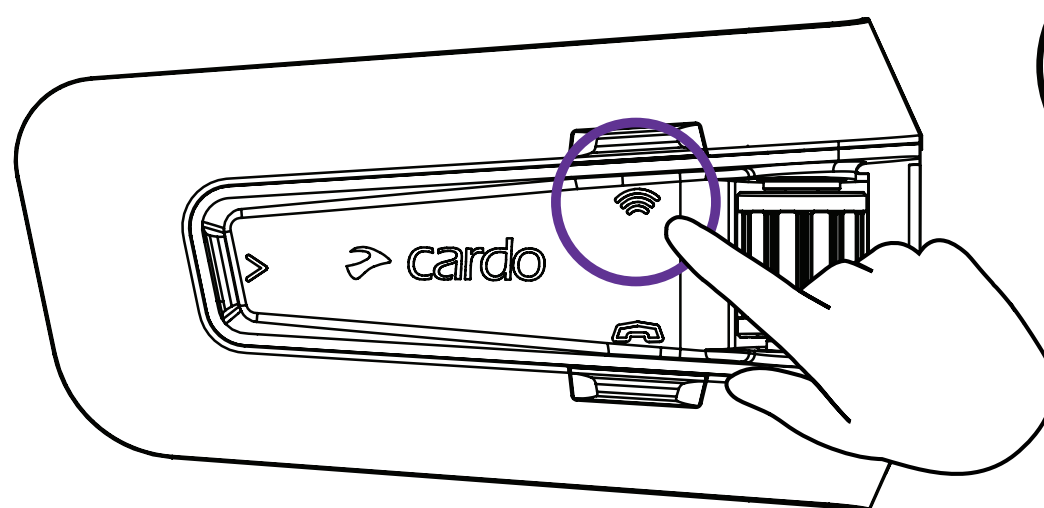

Advanced Features

DMC Intercom

Set Private Chat Partner

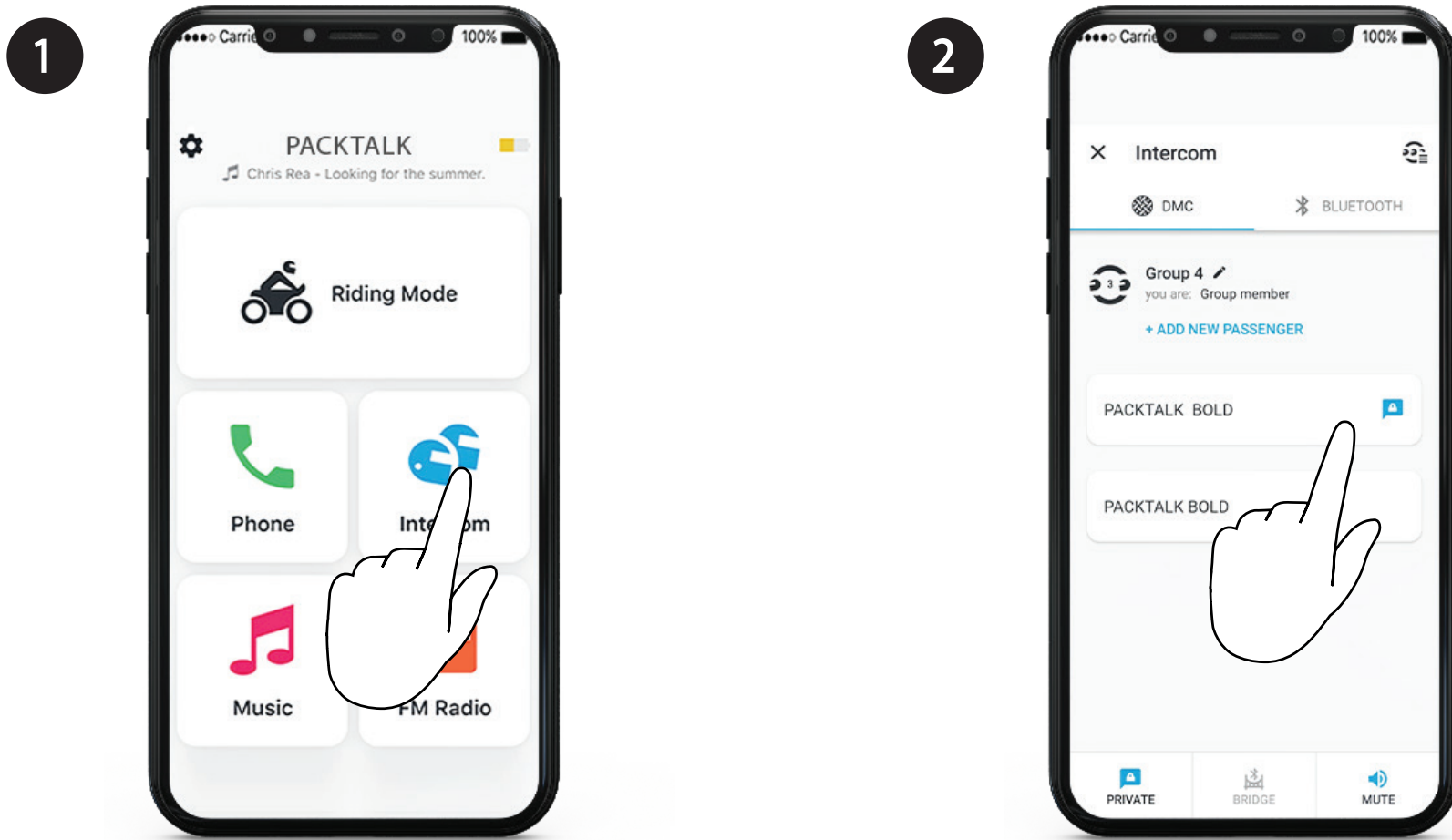

Start / Stop Private Chat

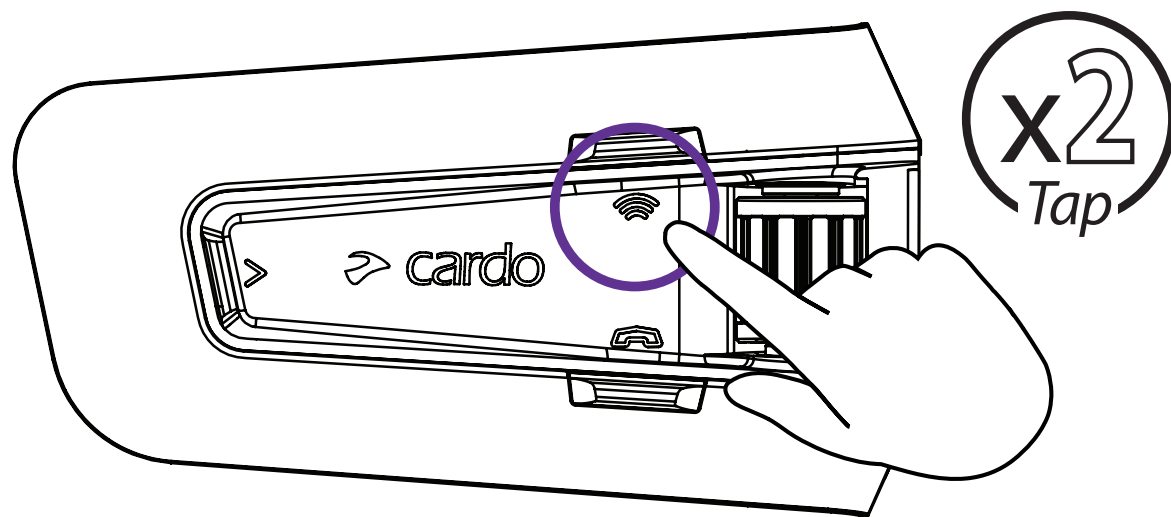

Add Bluetooth passenger

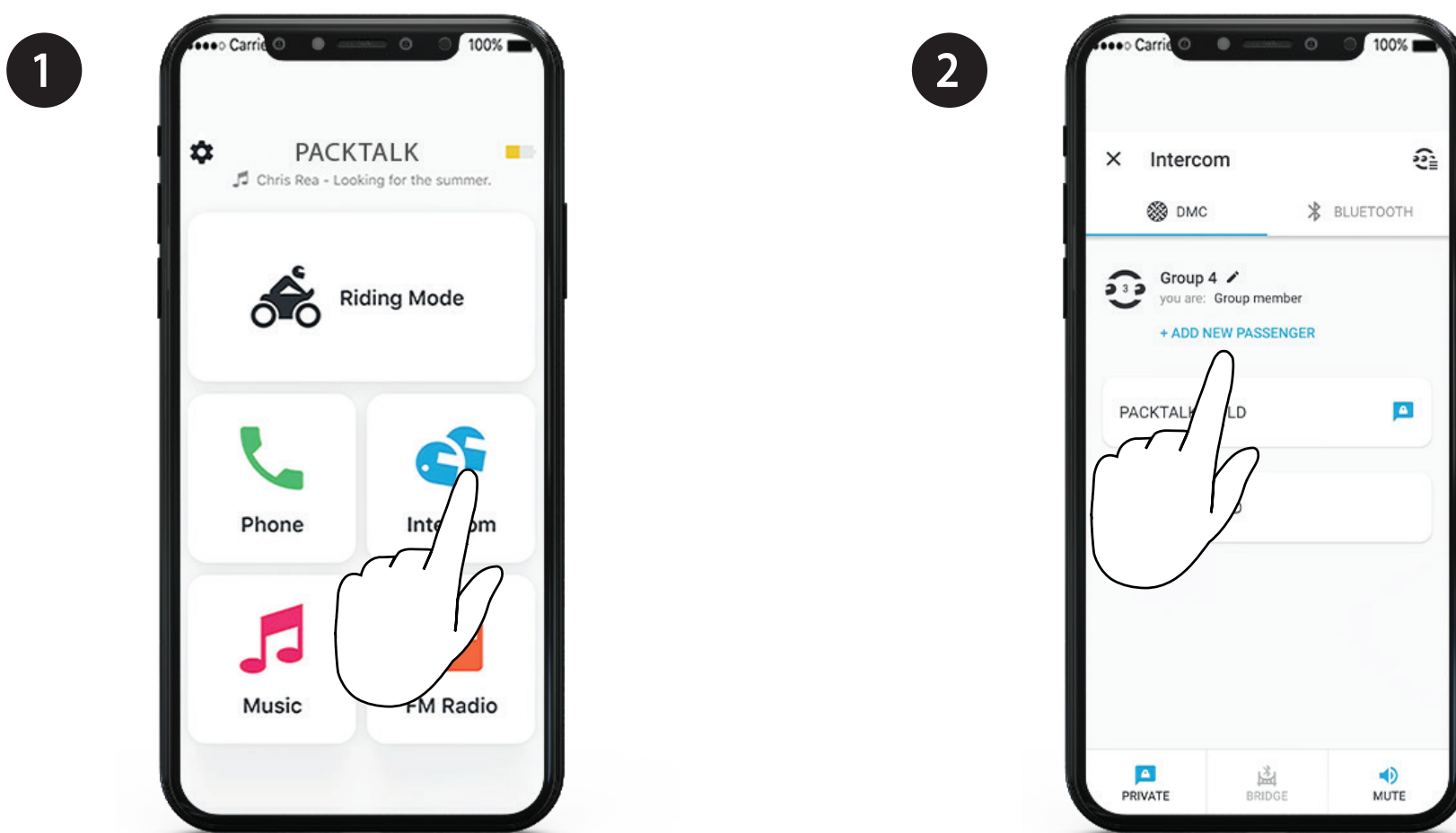

Start/Stop Passenger Intercom

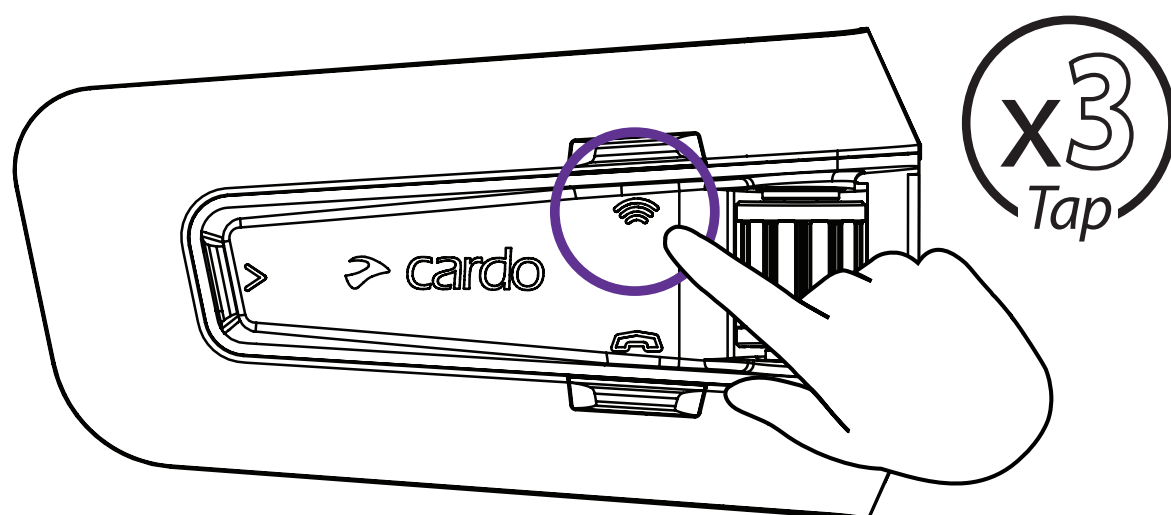

Advanced Features

Phone Call

★ Set Speed Dial

1

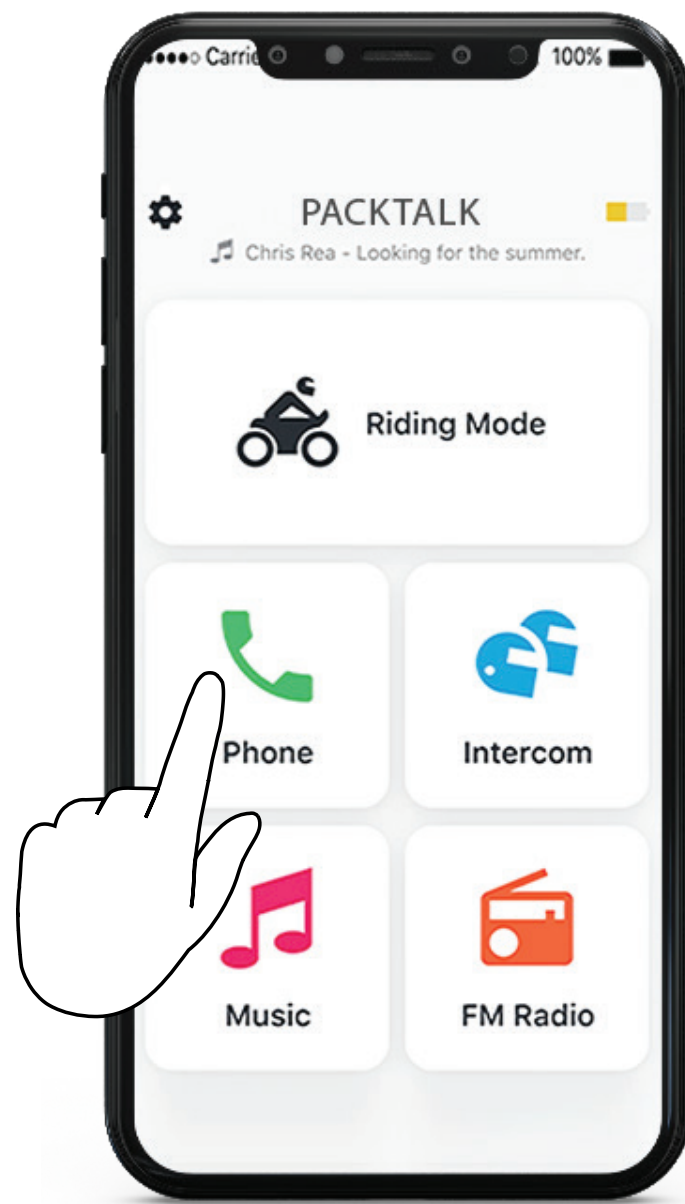

2

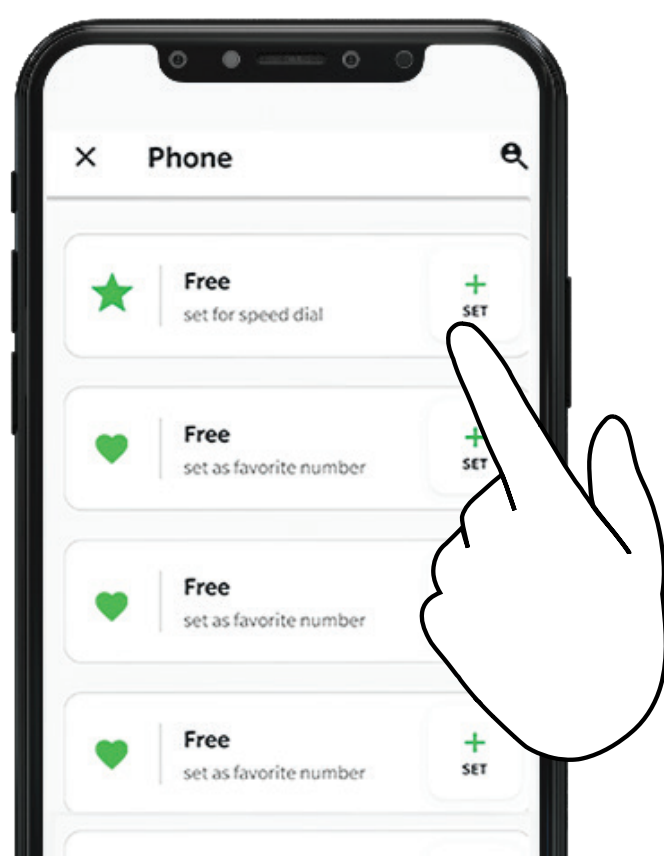

3

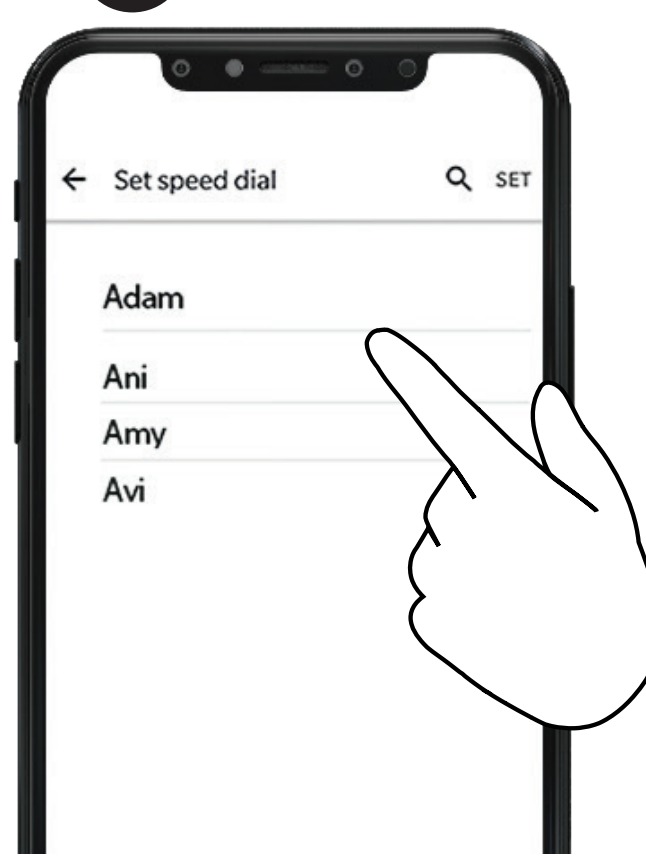

★ Call Speed Dial

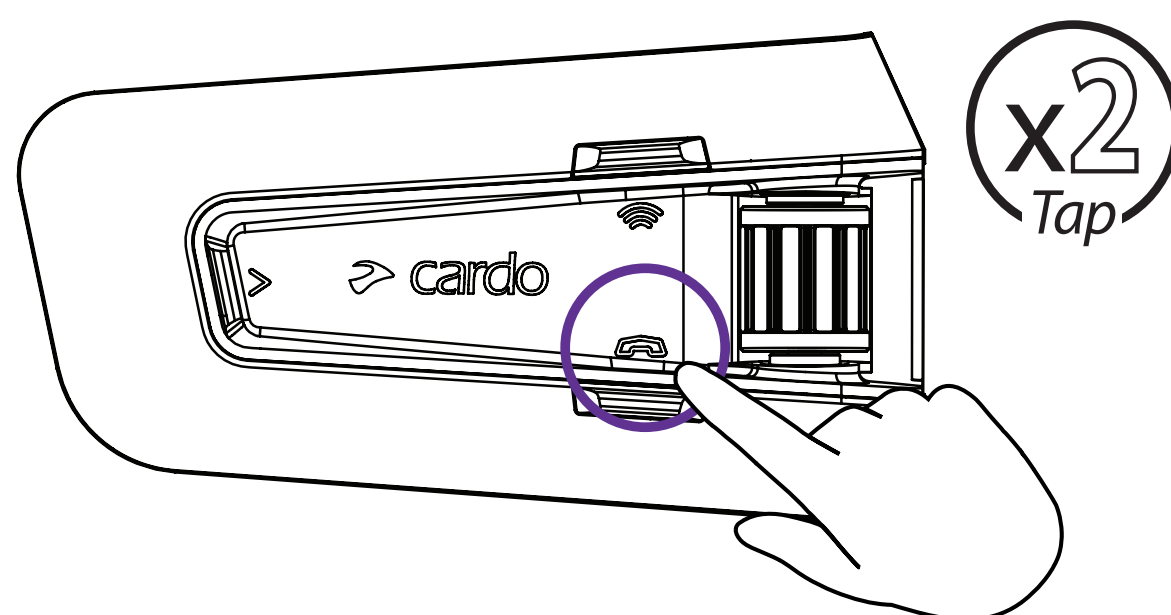

Advanced Features

GPS Pairing

1 Step 1

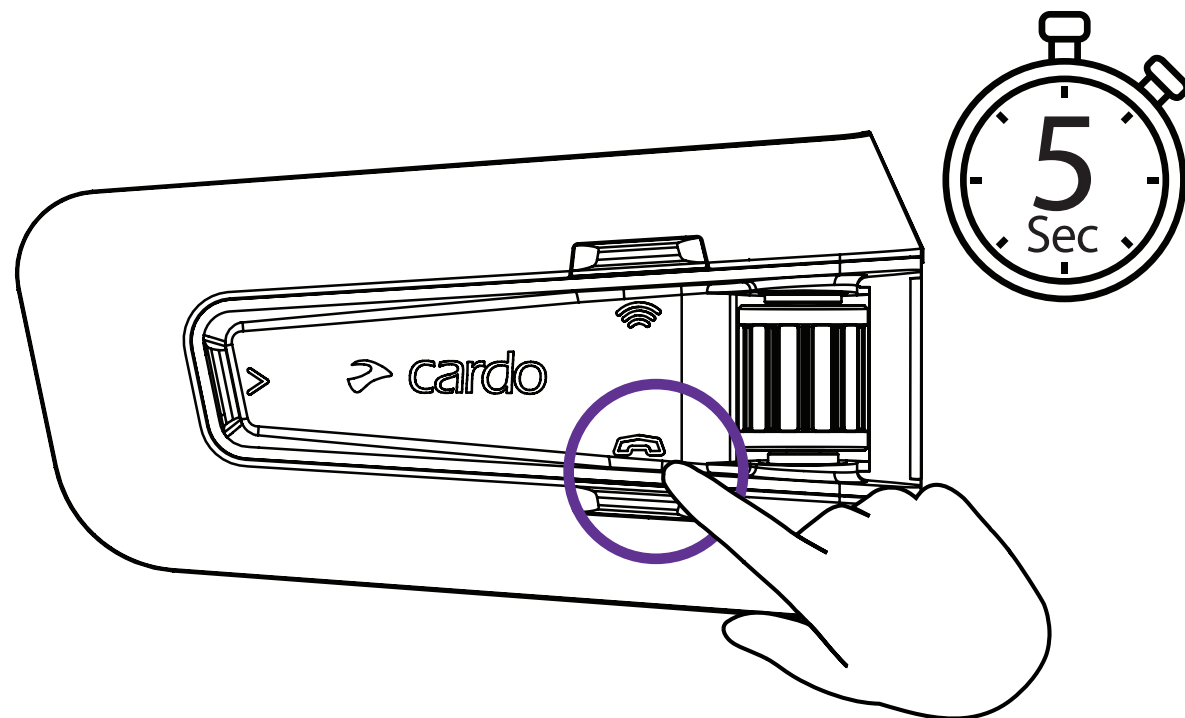

LED Red & Blue



2 Step 2

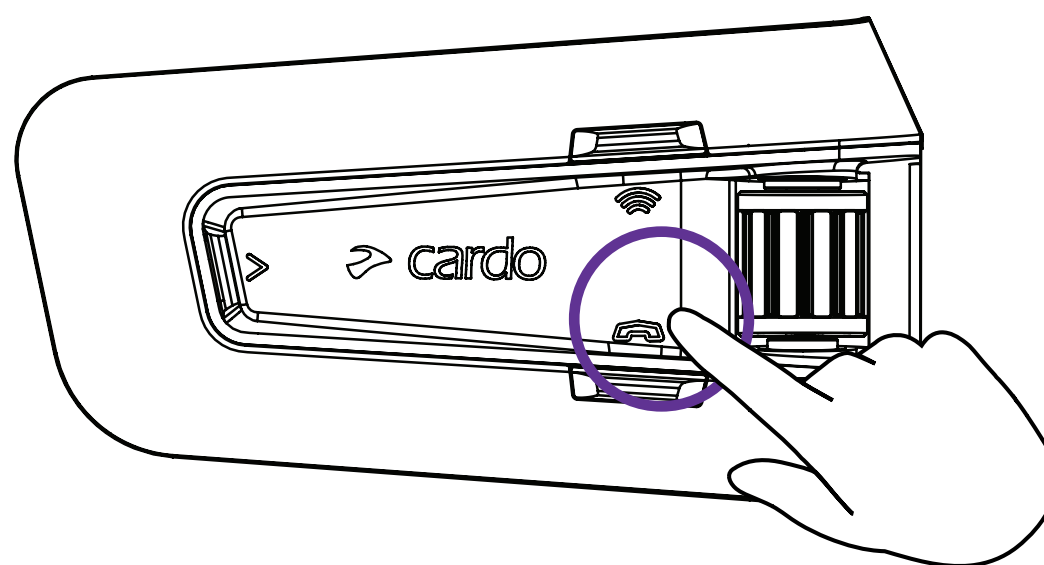

LED Red & Green



3 Step 3



Advanced Features

Universal Bluetooth intercom

Bluetooth Intercom Pairing

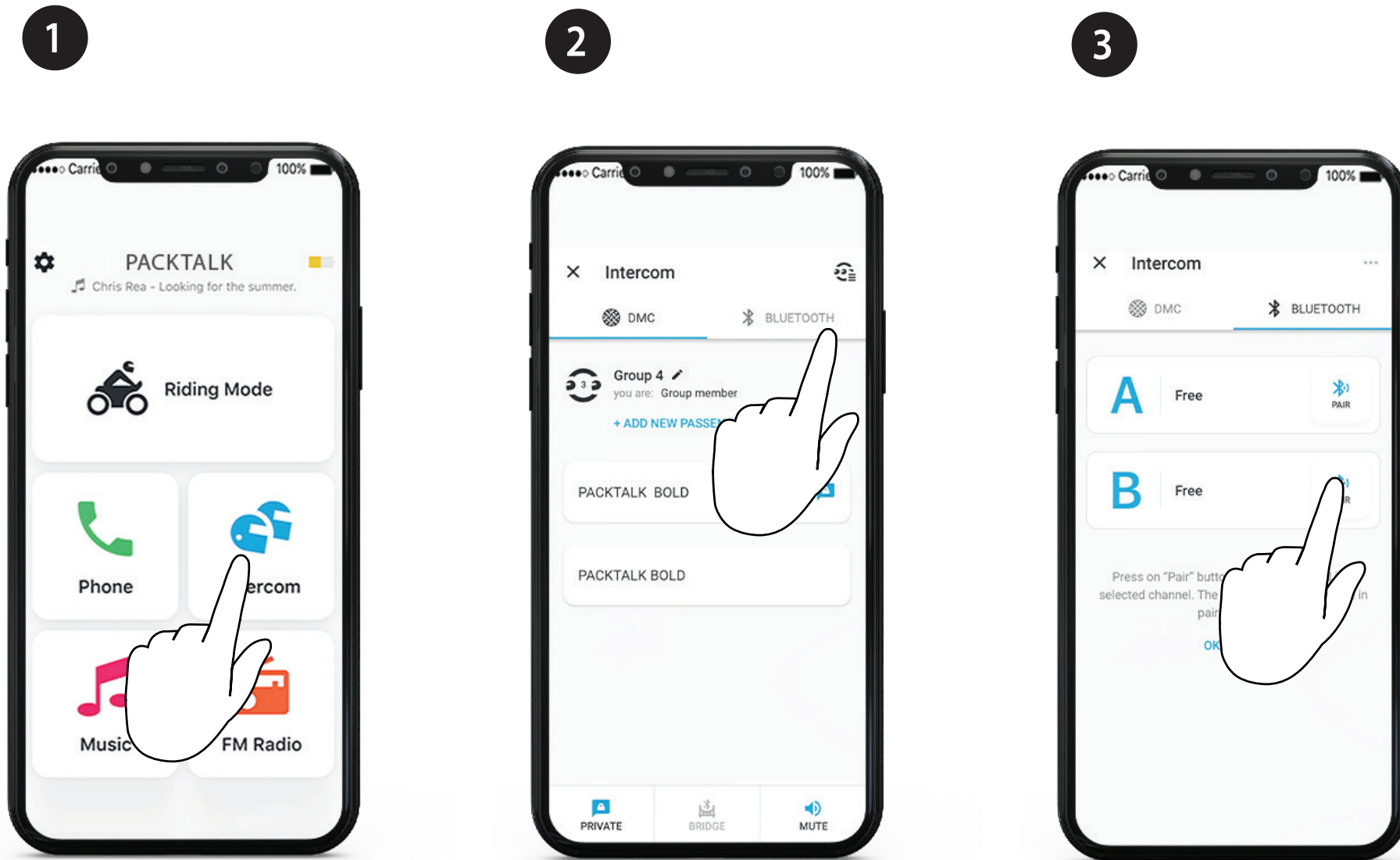

Start / Stop Intercom

Rider A

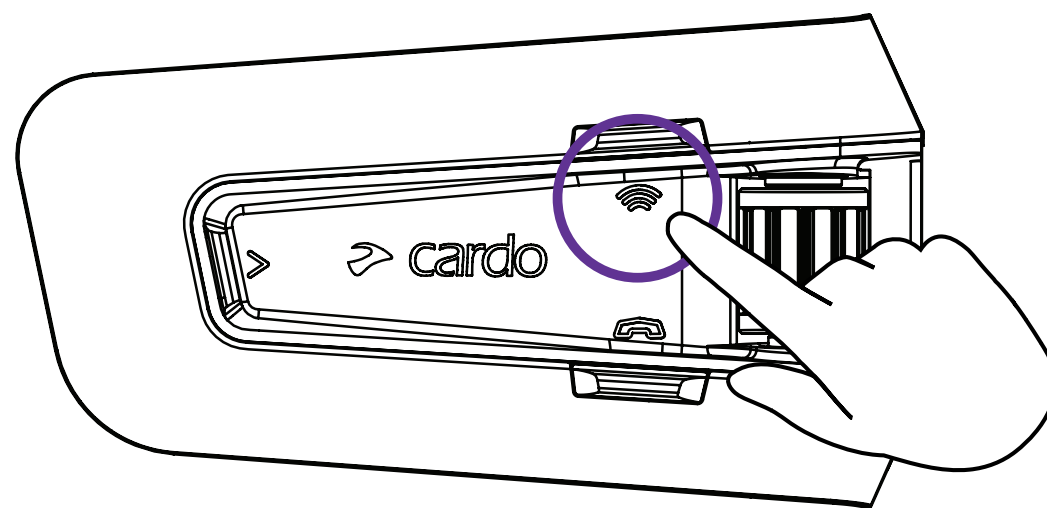

x1
Tap

Start / Stop Intercom

Rider B

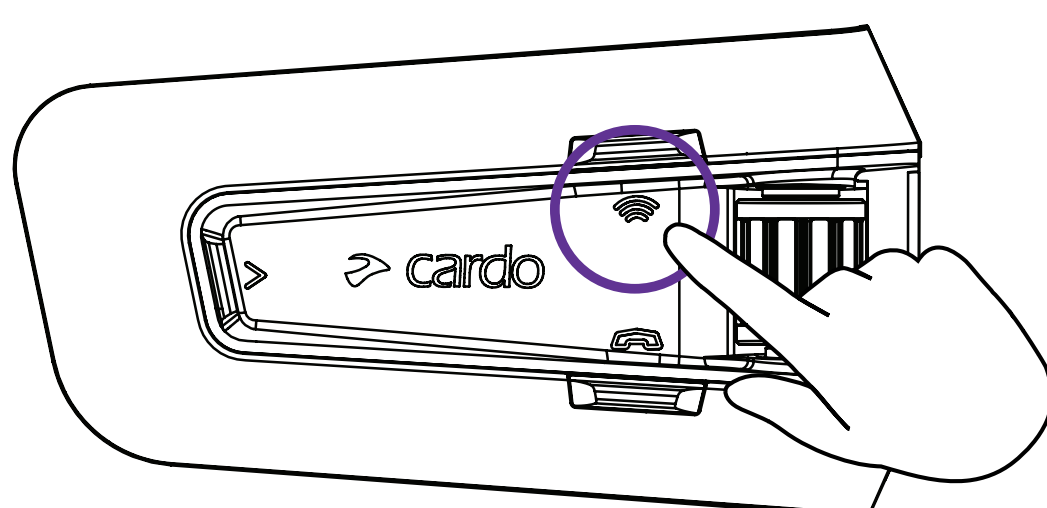

x2
Tap

Advanced Features

Reboot

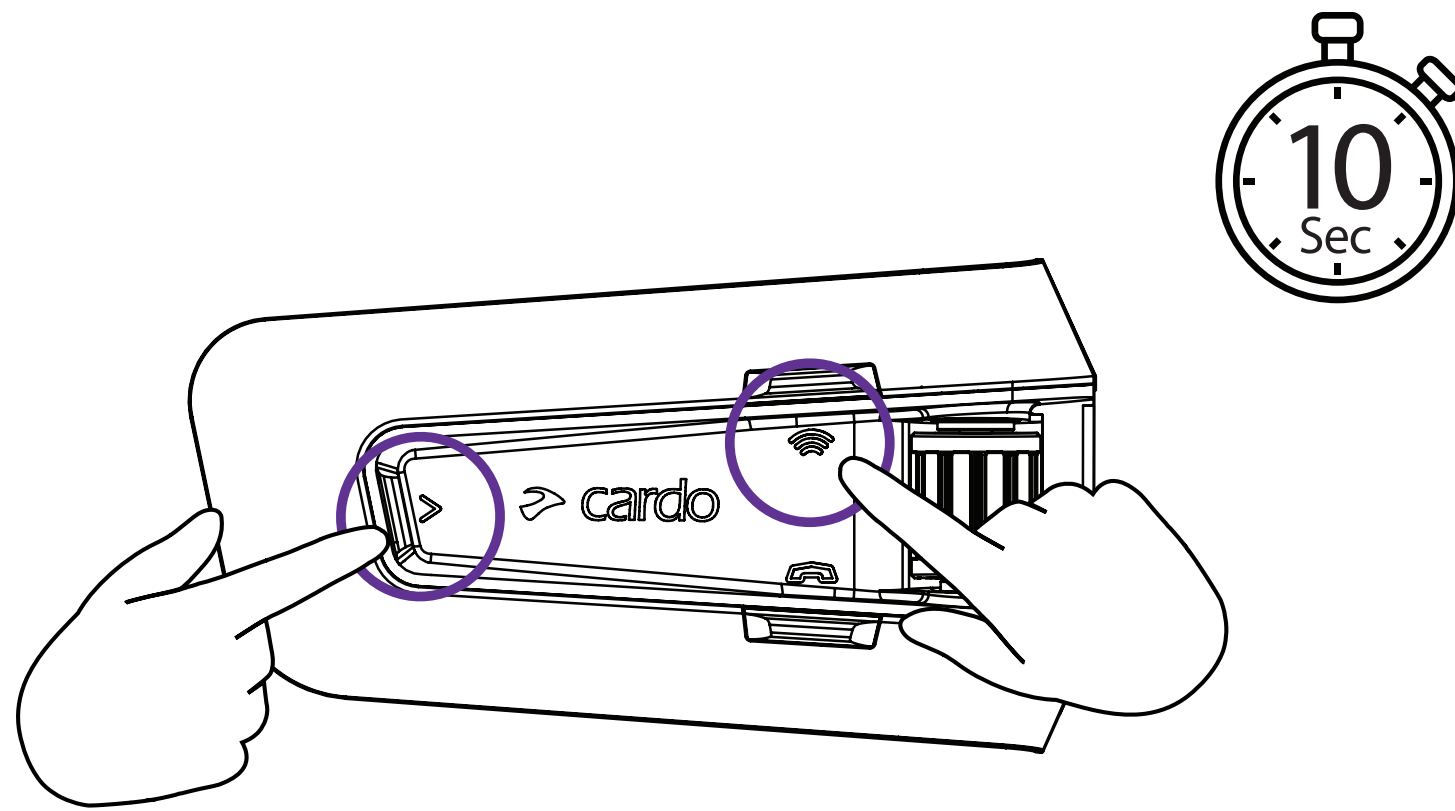

Factory Reset

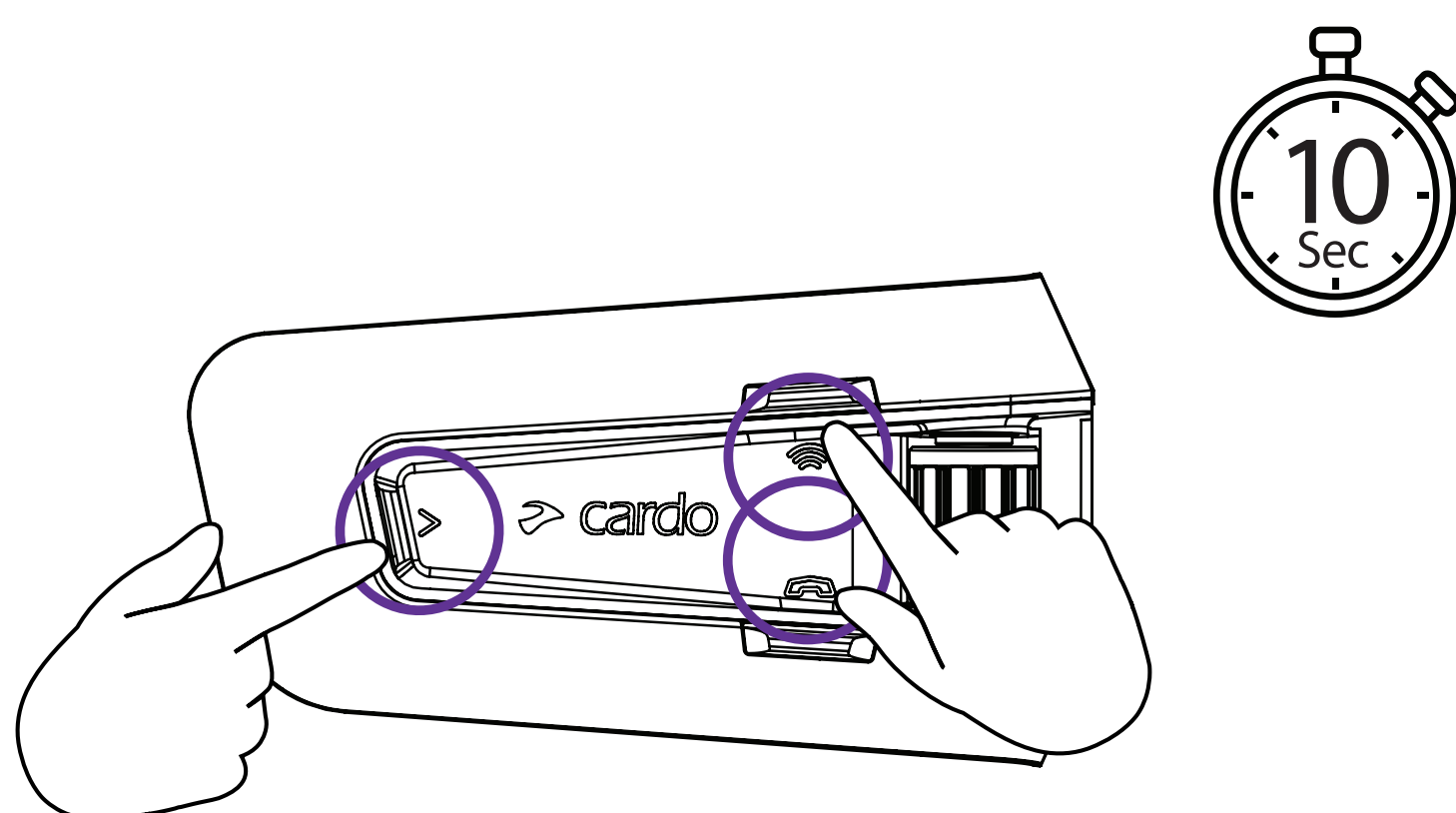

Voice Commands - Always On!

E English



- **Answer**
- **Ignore**
- "Hey Cardo, **end call**"
- "Hey Cardo, **speed dial**"
- "Hey Cardo, **redial number**"



- "Hey Cardo, **music on**"
- "Hey Cardo, **music off**"
- "Hey Cardo, **next track**"
- "Hey Cardo, **previous track**"
- "Hey Cardo, **share music**"



- "Hey Cardo, **radio on**"
- "Hey Cardo, **radio off**"
- "Hey Cardo, **next station**"
- "Hey Cardo, **previous station**"



For Bluetooth intercom only

- "Hey Cardo, **call intercom**"
- "Hey Cardo, **end intercom**"



- **"Hey Siri"**
- **"OK Google"**



- "Hey Cardo, **volume up**"
- "Hey Cardo, **volume down**"
- "Hey Cardo, **mute audio**"
- "Hey Cardo, **unmute audio**"
- "Hey Cardo, **mute microphone**"
- "Hey Cardo, **unmute microphone**"



- "Hey Cardo, **battery status**"

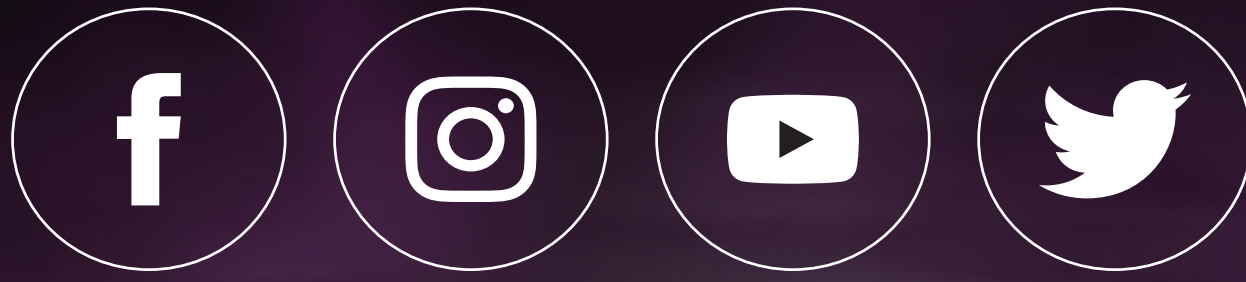

cardosystems.com



Cardo Connect App

Cardosystems.com/update

Cardosystems.com/support