

## DIY Hobby Spray Booth Assembly Instructions

### Materials you will need

- ✓ 1/2 inch thick plywood (see cut list and assembly instructions)
- ✓ 1/4 inch thick plexiglass (see cut list and assembly instructions)
- ✓ 22 Philips head wood screws # 6 x 1 1/4 inch long.
- ✓ 1 small tube of caulking or silicone sealant.
- ✓ 12" x 24" x 1" pleated furnace filter.

### Tools you will need

- ✓ Circular saw or table saw.
- ✓ Drill and 3/32 inch drill bit.
- ✓ Philips head screw driver.
- ✓ 1/4 inch hex head driver.



### DIY Kit Contents

- ✓ 265 CFM exhaust blower, 115 volt, 1.9 amp, 1500 RPM, with 24 gauge galvanized steel mounting panel.
- ✓ 4 inch round exhaust duct outlet for easy venting (standard dryer vent)
- ✓ 7 foot long grounded power cord.
- ✓ 24 gauge galvanized steel filter rack, for use with standard furnace replacement filter. 12" x 24" x 1"
- ✓ Material cut list and assembly instructions.

## Assembly Instructions

1. Cut plywood and plexiglass pieces according to cut list.
2. Assemble bottom, sides, back and front panels as shown on the exploded view drawing, use 18 qty # 6 x 1¼ inch wood screws. Note: predrill holes at screw locations to avoid splitting wood. If using flathead screws use countersink drill bit.
3. Place exhaust fan panel on booth as shown on the exploded view drawing. Note: the fan panel can be placed with the exhaust outlet facing up or down.
4. Assemble filter rack finger tight with bolts provided. (8 qty # 6 x ½ inch bolts and nuts)
5. Insert filter rack into booth with top of rack adjacent to top of fan panel. Screw filter rack to sides of booth from inside with 4 hex head screws provided. (or you could use 4 qty # 8 x ½ inch zip screws) Now tighten the filter rack bolts.
6. Place plexiglass panel on top of filter rack and front panel.
7. Screw fan panel from sides in 4 locations with hex head screws provided. (or you could use 4 qty # 8 x ½ inch zip screws)
8. Seal any air gaps inside booth with caulking or silicone sealant.

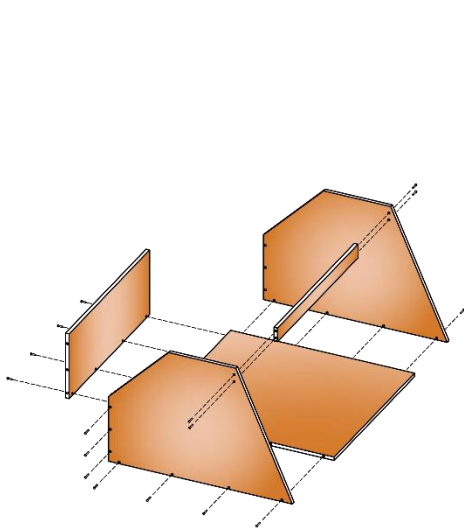

PLYWOOD BOX  
ASSEMBLING

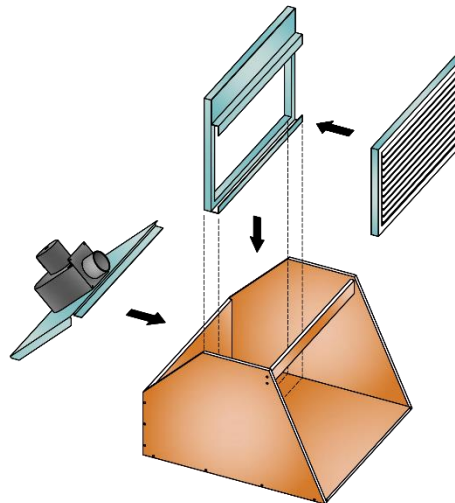

EQUIPMENT  
ASSEMBLING

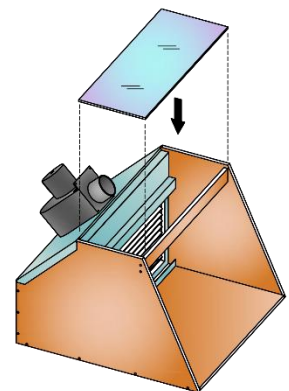

GLASS  
ASSEMBLING

To Watch the Assemble Video Go To  
[www.youtube.com/user/VentWorksVideo](http://www.youtube.com/user/VentWorksVideo)

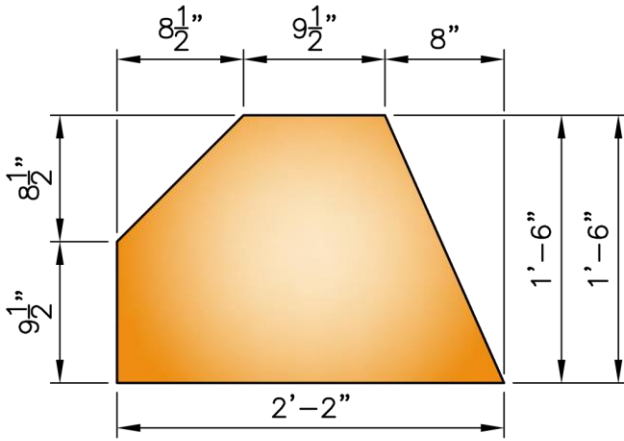

DETAIL ITEM - 1

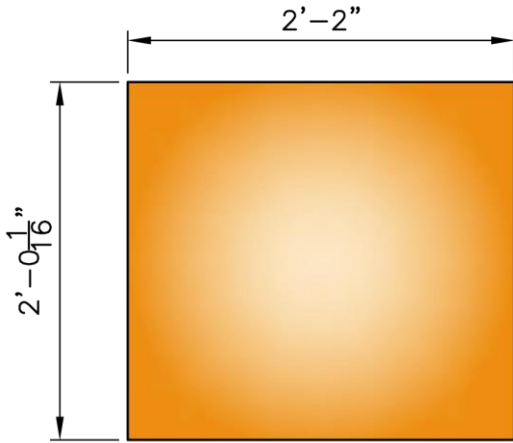

DETAIL ITEM - 2

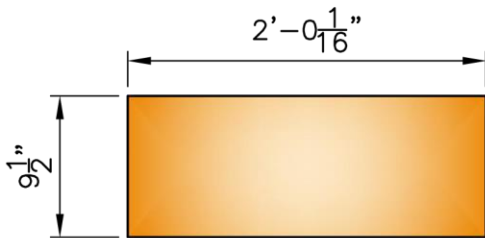

DETAIL ITEM - 3



DETAIL ITEM - 4

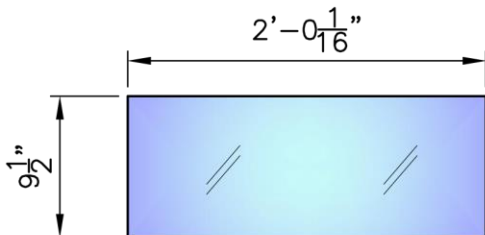

DETAIL ITEM - 5

MATERIAL LIST		
ITEM No.	QTY.	DESCRIPTION
1	2	1/2" PLYWOOD LEFT & RIGHT SIDE PLATE
2	1	1/2" PLYWOOD BOTTOM PLATE
3	1	1/2" PLYWOOD BACK PLATE
4	1	1/2" PLYWOOD FRONT PLATE
5	1	PLEXIGLAS TOP PLATE

**CUT LIST**  
SCALE 1" : 12"

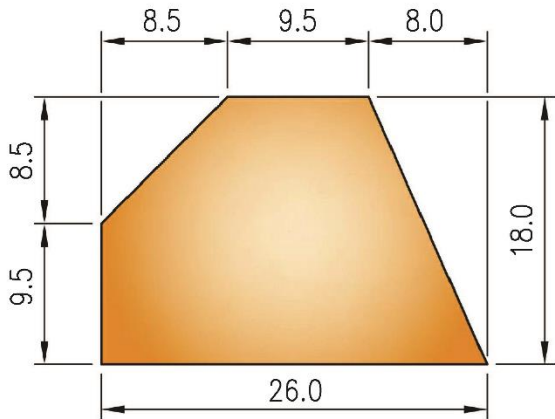

DETAIL ITEM - 1

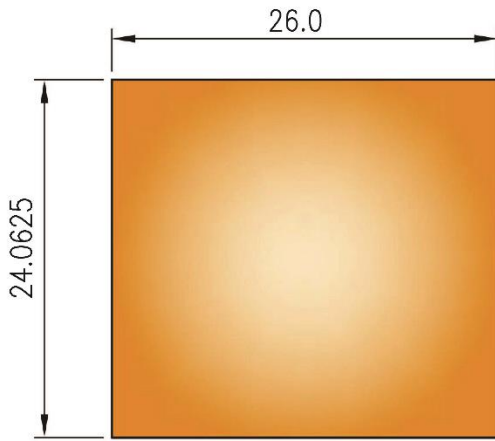

DETAIL ITEM - 2

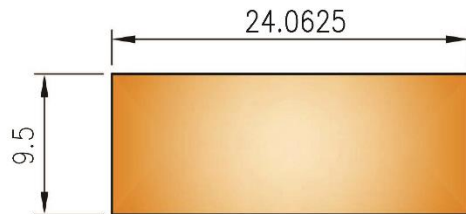

DETAIL ITEM - 3



DETAIL ITEM - 4

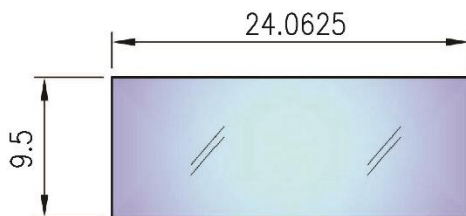

DETAIL ITEM - 5

MATERIAL LIST		
ITEM No.	QTY.	DESCRIPTION
1	2	0.5" PLYWOOD LEFT & RIGHT SIDE PLATE
2	1	0.5" PLYWOOD BOTTOM PLATE
3	1	0.5" PLYWOOD BACK PLATE
4	1	0.5" PLYWOOD FRONT PLATE
5	1	PLEXIGLAS TOP PLATE

**CUT LIST**

SCALE 1.0dec : 12dec

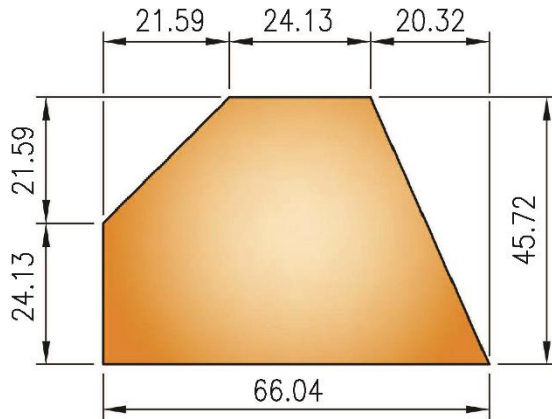

DETAIL ITEM - 1

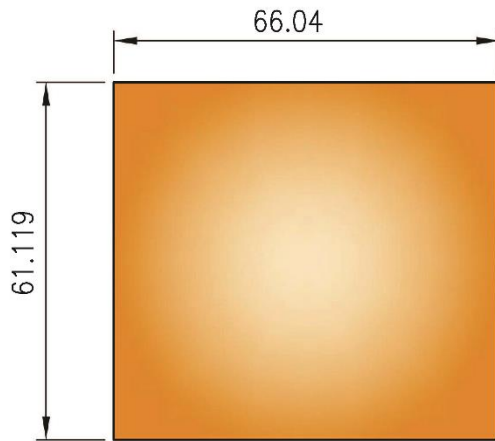

DETAIL ITEM - 2

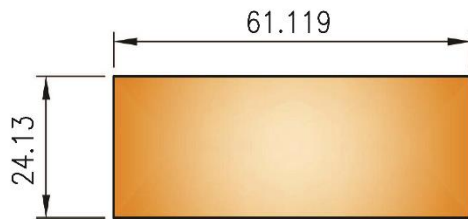

DETAIL ITEM - 3

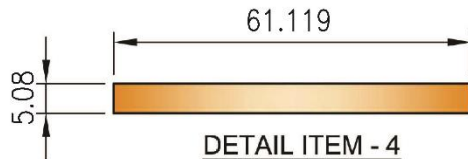

DETAIL ITEM - 4

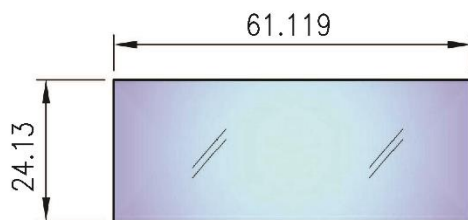

DETAIL ITEM - 5

MATERIAL LIST		
ITEM No.	QTY.	DESCRIPTION
1	2	1.27 PLYWOOD LEFT & RIGHT SIDE PLATE
2	1	1.27 PLYWOOD BOTTOM PLATE
3	1	1.27 PLYWOOD BACK PLATE
4	1	1.27 PLYWOOD FRONT PLATE
5	1	PLEXIGLAS TOP PLATE

**CUT LIST**

SCALE 2.54cm : 30.48cm