



SUBARU

WRX / WRX STI FOG LAMP KIT

INSTALLATION INSTRUCTION

PART No. H4510VA030



IMPORTANT

1. Read all instructions before proceeding with installation. If uncomfortable performing any procedures, such as lamp aiming in step 17, have installation performed by a Subaru dealer technician.
2. Pay special attention not to damage vehicle components when removing / installing them.
3. Route wiring so that it does not rub against any sharp edges.

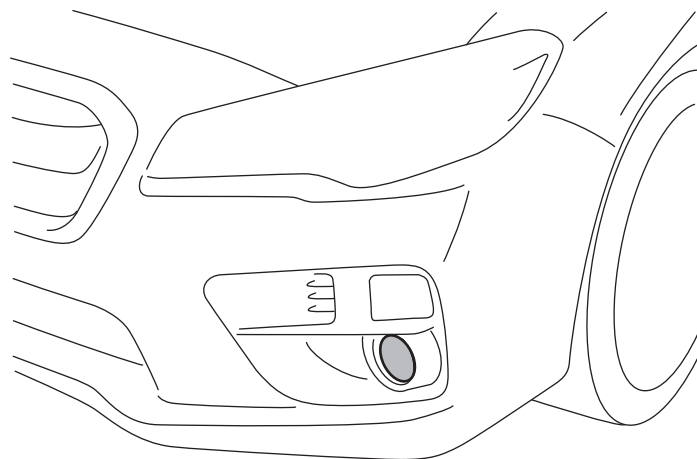

Components

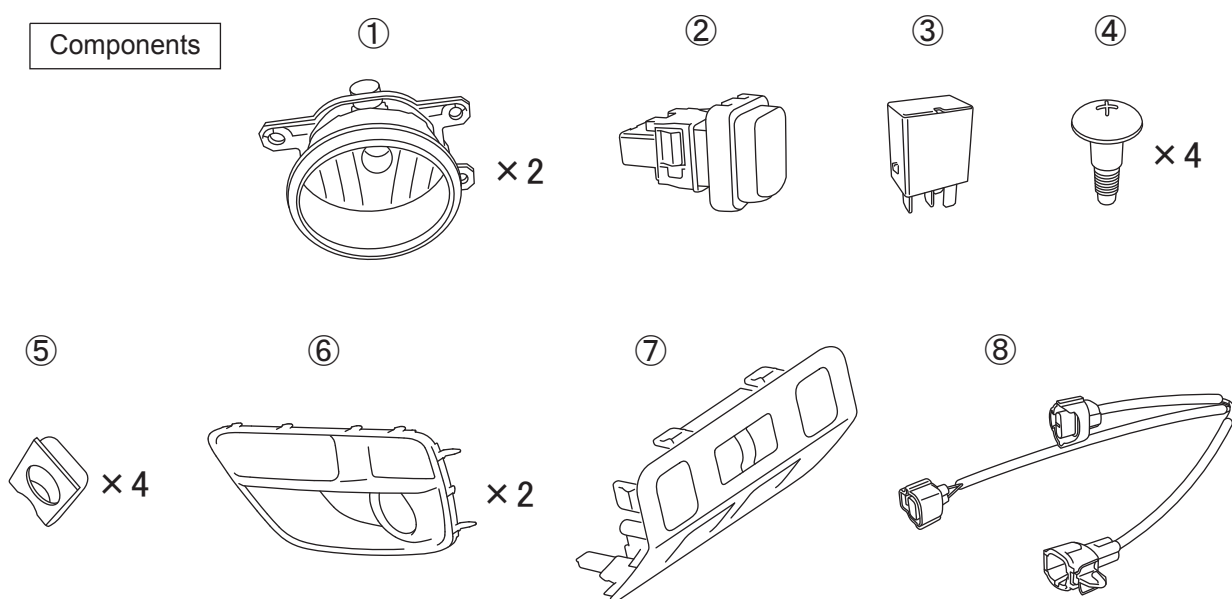

Tools

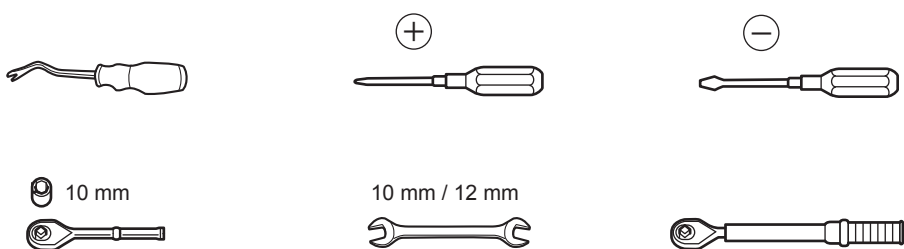

1

STI model

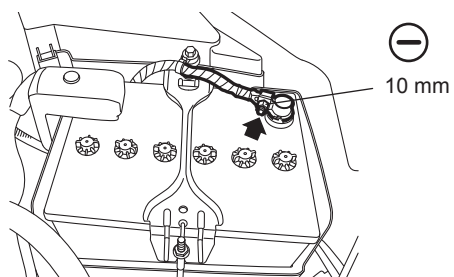

Except for STI model

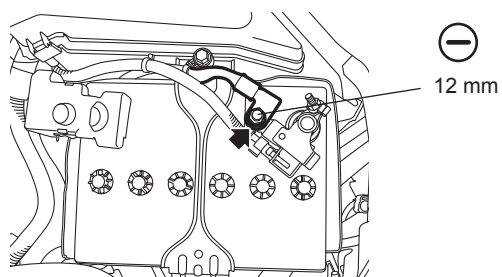

2

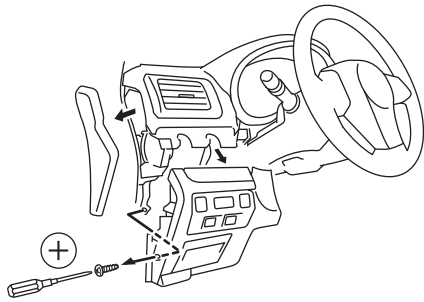

3

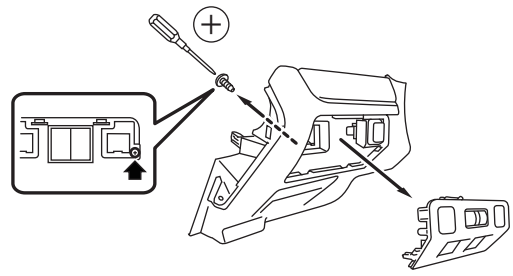

4

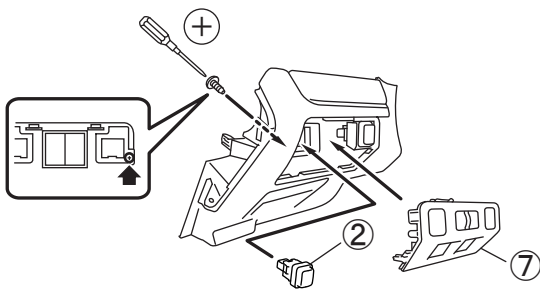

Transfer the switches, blanks or dials to the new panel.

5

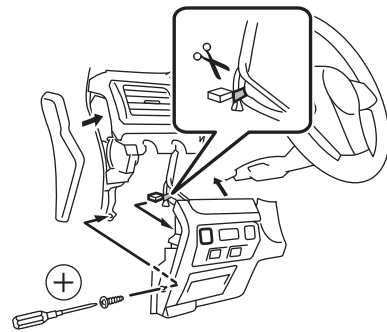

6

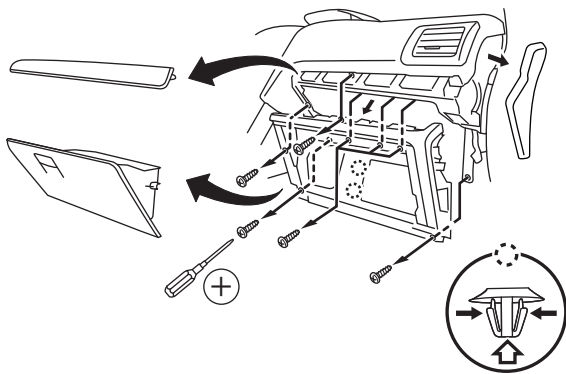

7

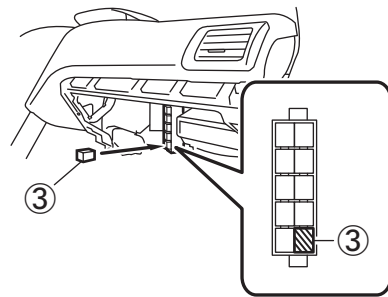

8

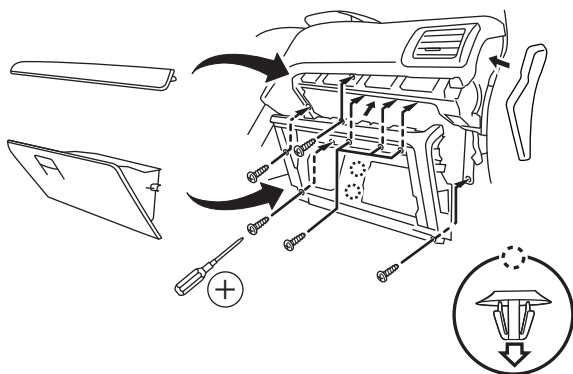

9

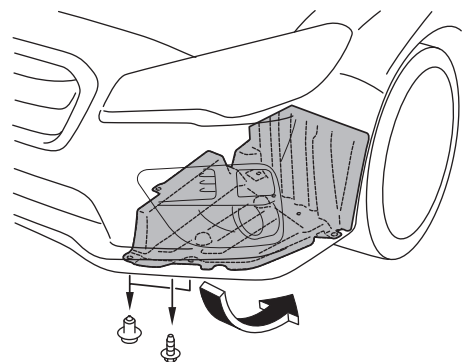

10

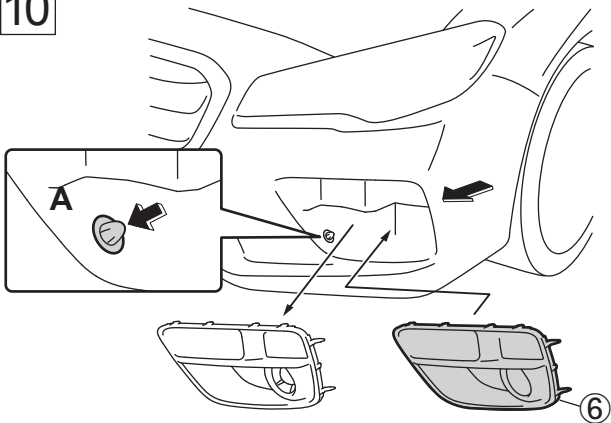

11

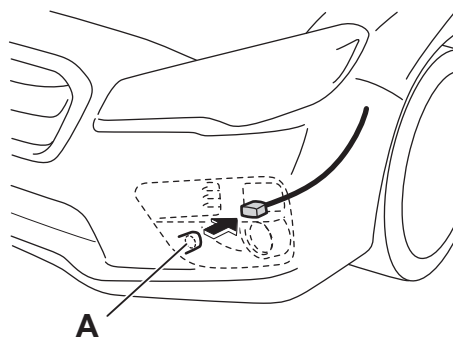

12

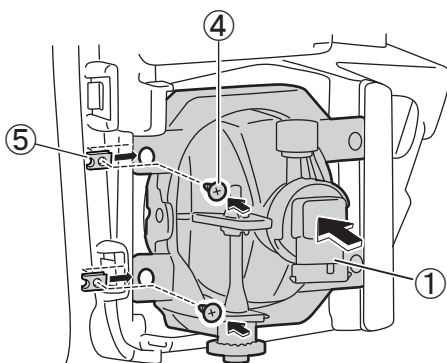

13

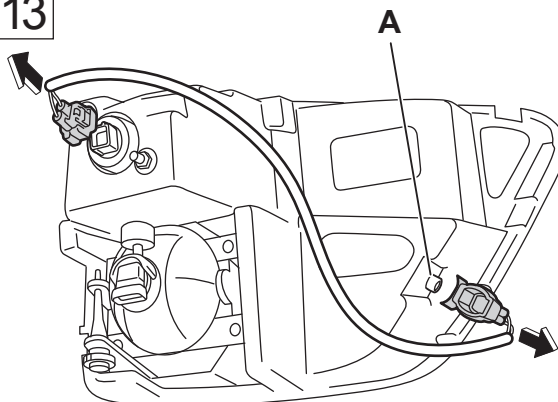

14

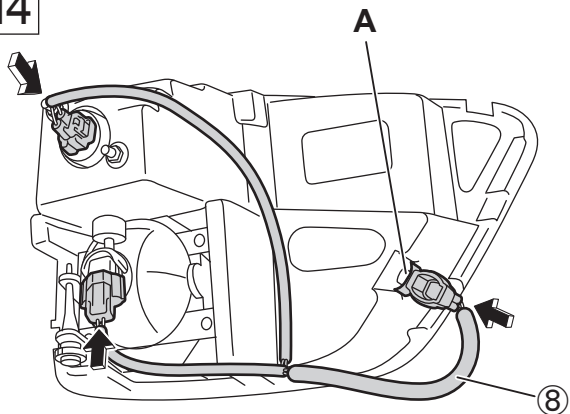

15

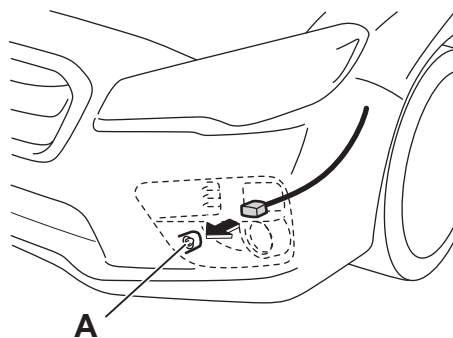

16

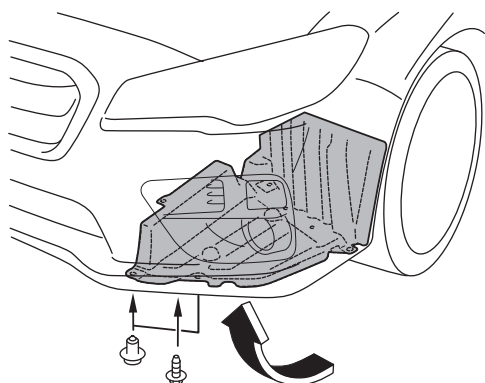

17

STI model

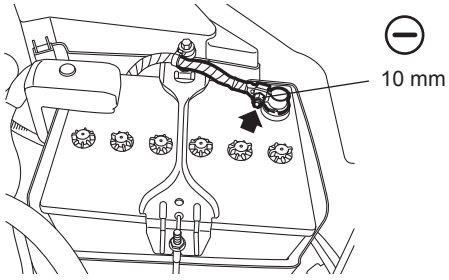

Except for STI model

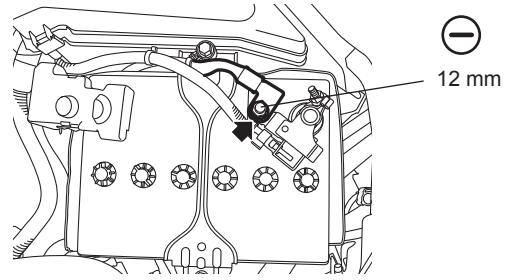

18

Wall View

