

## **KYOWA SERVICE CENTER**

Rm. 1203 State Center Building  
#333 Juan Luna St., Binondo  
Manila, Philippines



## **VACUUM CLEANER**

**MODEL # KW-6002**

Voltage: 230V a.c. 60Hz Power: 1200 WATTS



## **INSTRUCTION MANUAL**

## CONGRATULATIONS

You are now a proud new owner of a KYOWA Vacuum Cleaner model no. KW-6002.

Before using for the first time, kindly take time to carefully read your instruction manual. Please observe all safety precautions and follow operating procedures. After reading, kindly store your instruction manual in a safe place for your future reference. Should you pass on this Vacuum Cleaner to a third party, please hand over this instruction manual as well.

## PARTS DESCRIPTION

- A. Handle
- B. Hose
- C. Wind-force Adjuster
- D. Tube
- E. Floor Brush
- F. Hose Connector
- G. Front Cover
- H. Indicator
- I. Power Switch
- J. Cable Rewind Button
- K. Speed Controller

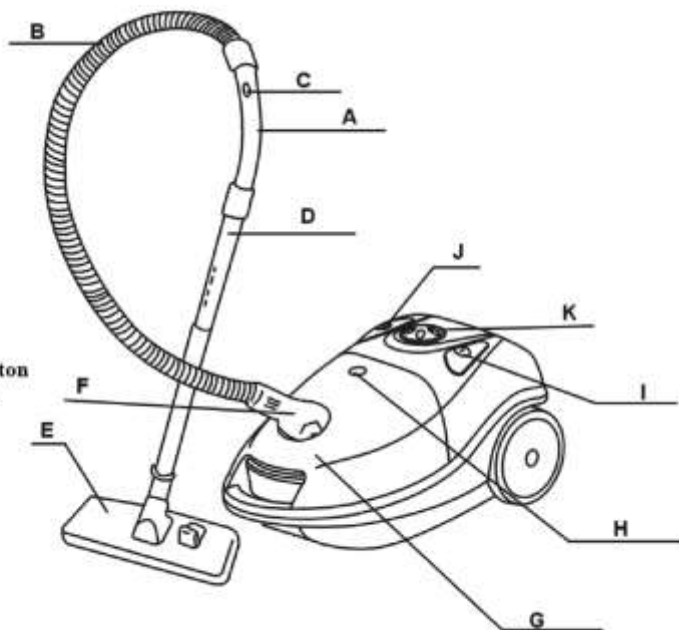

1

## IMPORTANT SAFEGUARDS

When using the Vacuum Cleaner, basic safety precautions should always be followed:

- Always operate your KYOWA Vacuum Cleaner from a power source of the same voltage and frequency rating as indicated on the rating label.
- Do not operate or place any part of your KYOWA Vacuum Cleaner on or near any hot surface such as a gas or electric burner, hotplate or heated oven. (FIG. 1)
- Do not operate the Vacuum Cleaner if any part of it has been damaged. Return the appliance to the nearest authorized dealer or service facility for repair.
- To reduce the risk of electric shock, do not immerse or expose the Vacuum Cleaner to rain, moisture or any liquid.
- Do not run the appliance over the power cable. (FIG. 2)
- Do not use Vacuum Cleaner to vacuum lighted matches, cigarette ends or hot ashes. (FIG. 3)
- Do not use Vacuum Cleaner in damp or wet area.
- Do not use unit to vacuum liquids. (FIG. 4)
- Do not obstruct the air intake or outlet vents. (FIG. 5)
- Do not use Vacuum Cleaner to vacuum needles, drawing pins or string. (FIG. 6)
- Do not use or replace accessories other than the ones originally provided.
- Never leave the Vacuum Cleaner unattended when in use.
- Switch OFF and unplug the Vacuum Cleaner outlet before emptying, when not in use or before cleaning.
- Hold plug when unplugging from socket. Do not unplug by pulling the supply cord or the Vacuum Cleaner itself.
- Keep out of reach from children or from persons with mental or physical disabilities.
- This KYOWA Vacuum Cleaner is intended for normal domestic/household use only. This unit is not suitable for commercial use.

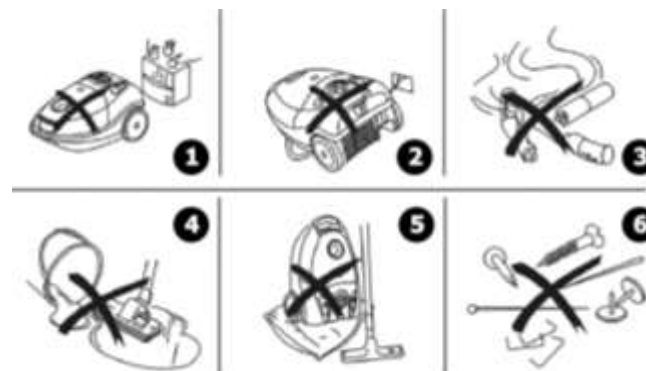

2

## HOW TO USE

### ASSEMBLING THE VACUUM CLEANER

- Fit Extension Tube to the Handle of the Vacuum Cleaner.
- Jointly fit Extension Tubes. Make sure that both tubes are firmly attached together.



- Attach Floor Brush to the Extension Tube.
- To release Flexible Tube from the vacuum, firmly press button on the end of the tube from the air intake duct.

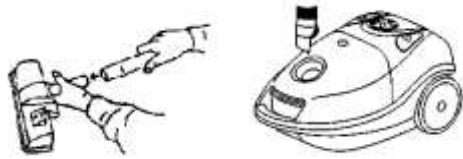

### USING THE VACUUM CLEANER

- Before using the Vacuum Cleaner, unwind cable then insert plug into the power outlet. Yellow mark on the power cable shows the ideal cable length; do not extend beyond the red mark.

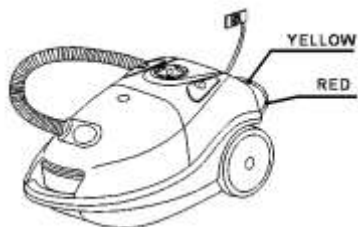

3

- To rewind power cable, press Rewind Button. Rest hand on the vacuum while rewinding to support the unit.
- Set electronic power regulator to MIN then press ON/OFF switch to turn the vacuum ON.

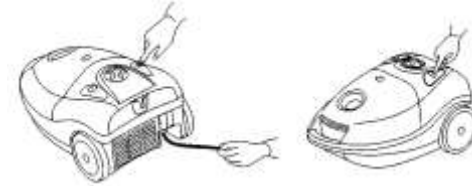

- Adjust absorption power by turning the Speed Control Knob.
- Turn OFF unit after every use.

### CLEANING ACCESSORIES

- **Floor brush**
  - Bristles are extended, used when cleaning hard floors.
- **Carpet brush**
  - Bristles are retracted, used when cleaning carpets.

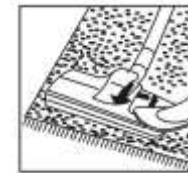

- **Narrow nozzle**
  - Used for cleaning radiators, corners, edges, drawers and etc.
- **Small brush**
  - Used for cleaning curtains, shelves, books, inlaid furniture, lamps and other delicate objects.



4

## CLEAN AND CARE

- After removing the flexible tube, open front cover by pressing the button pulling upwards.
- Remove the dust bag.



- When motor filter is dirty, remove the filter and wash carefully in soapy liquid or clear water. Allow the filter to dry completely before putting it back on the vacuum Cleaner.

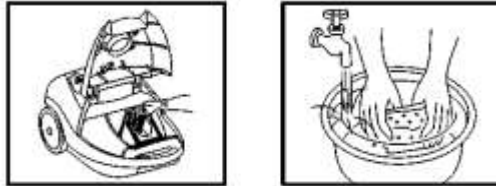

## SERVICE

- Do not operate your KYOWA Vacuum Cleaner if the unit malfunctions or appears damaged in any manner. Bring the complete unit to the place of purchase or to any authorized KYOWA dealers for inspection, repair or replacement.
- Do not disassemble your KYOWA Vacuum Cleaner by yourself. No user serviceable parts inside. Refer all needed repair to an authorized KYOWA service facility ONLY.